

Micropower Precision Low Dropout Series Voltage Reference Family

FEATURES

- Trimmed to High Accuracy: 0.04% Max
- Low Drift: 3ppm/°C Max
- Low Supply Current: 50µA Max
- Temperature Coefficient Guaranteed to 125°C
- High Output Current: 50mA Min
- Low Dropout Voltage: 300mV Max
- Excellent Thermal Regulation
- Power Shutdown
- Thermal Limiting
- Operating Temperature Range: -40°C to 125°C
- Voltage Options: 2.5V, 3V, 3.3V, 4.096V and 5V

APPLICATIONS

- A/D and D/A Converters
- Precision Regulators
- Handheld Instruments
- Power Supplies

DESCRIPTION

The LT[®]1461 is a family of low dropout micropower bandgap references that combine very high accuracy and low drift with low supply current and high output drive. These series references use advanced curvature compensation techniques to obtain low temperature coefficient and trimmed precision thin-film resistors to achieve high output accuracy. The LT1461 family draws only 35µA of supply current, making them ideal for low power and portable applications, however their high 50mA output drive makes them suitable for higher power requirements, such as precision regulators.

In low power applications, a dropout voltage of less than 300mV ensures maximum battery life while maintaining full reference performance. Line regulation is nearly immeasurable, while the exceedingly good load and thermal regulation will not add significantly to system error budgets. The shutdown feature can be used to switch full load currents and can be used for system power down. Thermal shutdown protects the part from overload conditions. The LT1461 is available in 2.5V, 3V, 3.3V 4.096V and 5V options.

 LTC and LT are registered trademarks of Linear Technology Corporation.

TYPICAL APPLICATION

Basic Connection

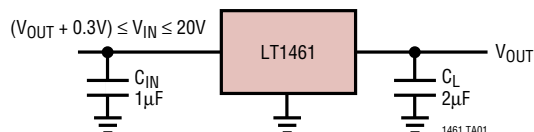

LT1461-2.5 Load Regulation, P_{DISS} = 200mW

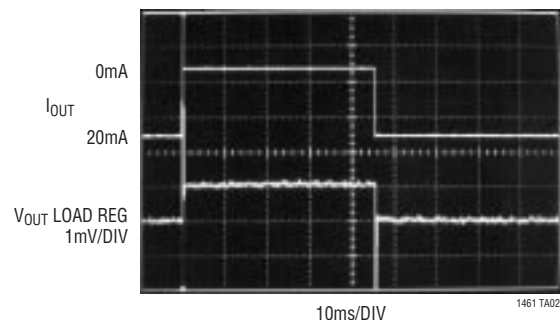

ABSOLUTE MAXIMUM RATINGS (Note 1)

| | | | |
|--|----------------|---|----------------|
| Input Voltage | 20V | Specified Temperature Range | |
| Output Short-Circuit Duration | Indefinite | Commercial | 0°C to 70°C |
| Operating Temperature Range | | Industrial | -40°C to 85°C |
| (Note 2) | -40°C to 125°C | High | -40°C to 125°C |
| Storage Temperature Range (Note 3) ... | -65°C to 150°C | Lead Temperature (Soldering, 10 sec)..... | 300°C |

PACKAGE/ORDER INFORMATION

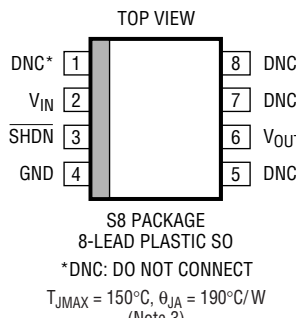
|  | ORDER PART NUMBER | | | S8 PART MARKING | | |
|--|-------------------|----------------|----------------|-----------------|--------|--------|
| | | LT1461ACS8-2.5 | LT1461ACS8-3.3 | LT1461ACS8-5 | 461A25 | 461A33 |
| | LT1461BCS8-2.5 | LT1461BCS8-3.3 | LT1461BCS8-5 | 461B25 | 461B33 | 1461B5 |
| | LT1461CCS8-2.5 | LT1461CCS8-3.3 | LT1461CCS8-5 | 461C25 | 461C33 | 1461C5 |
| | LT1461AIS8-2.5 | LT1461AIS8-3.3 | LT1461AIS8-5 | 61AI25 | 61AI33 | 461AI5 |
| | LT1461BIS8-2.5 | LT1461BIS8-3.3 | LT1461BIS8-5 | 61BI25 | 61BI33 | 461BI5 |
| | LT1461CIS8-2.5 | LT1461CIS8-3.3 | LT1461CIS8-5 | 61CI25 | 61CI33 | 461CI5 |
| | LT1461DHS8-2.5 | LT1461DHS8-3.3 | LT1461DHS8-5 | 61DH25 | 61DH33 | 461DH5 |
| | LT1461ACS8-3 | LT1461ACS8-4 | | 1461A3 | 1461A4 | |
| | LT1461BCS8-3 | LT1461BCS8-4 | | 1461B3 | 1461B4 | |
| | LT1461CCS8-3 | LT1461CCS8-4 | | 1461C3 | 1461C4 | |
| | LT1461AIS8-3 | LT1461AIS8-4 | | 461AI3 | 461AI4 | |
| | LT1461BIS8-3 | LT1461BIS8-4 | | 461BI3 | 461BI4 | |
| | LT1461CIS8-3 | LT1461CIS8-4 | | 461CI3 | 461CI4 | |
| | LT1461DHS8-3 | LT1461DHS8-4 | | 461DH3 | 461DH4 | |

Consult factory for Military grade parts.

AVAILABLE OPTIONS

| INITIAL ACCURACY | TEMPERATURE COEFFICIENT | TEMPERATURE RANGE | OUTPUT VOLTAGE | | | | |
|------------------|-------------------------|-------------------|----------------|--------------|----------------|--------------|--------------|
| | | | 2.5V | 3.0V | 3.3V | 4.096V | 5.0V |
| 0.04% Max | 3ppm/°C Max | 0°C to 70°C | LT1461ACS8-2.5 | LT1461ACS8-3 | LT1461ACS8-3.3 | LT1461ACS8-4 | LT1461ACS8-5 |
| 0.04% Max | 3ppm/°C Max | -40°C to 85°C | LT1461AIS8-2.5 | LT1461AIS8-3 | LT1461AIS8-3.3 | LT1461AIS8-4 | LT1461AIS8-5 |
| 0.06% Max | 7ppm/°C Max | 0°C to 70°C | LT1461BCS8-2.5 | LT1461BCS8-3 | LT1461BCS8-3.3 | LT1461BCS8-4 | LT1461BCS8-5 |
| 0.06% Max | 7ppm/°C Max | -40°C to 85°C | LT1461BIS8-2.5 | LT1461BIS8-3 | LT1461BIS8-3.3 | LT1461BIS8-4 | LT1461BIS8-5 |
| 0.08% Max | 12ppm/°C Max | 0°C to 70°C | LT1461CCS8-2.5 | LT1461CCS8-3 | LT1461CCS8-3.3 | LT1461CCS8-4 | LT1461CCS8-5 |
| 0.08% Max | 12ppm/°C Max | -40°C to 85°C | LT1461CIS8-2.5 | LT1461CIS8-3 | LT1461CIS8-3.3 | LT1461CIS8-4 | LT1461CIS8-5 |
| 0.15% Max | 20ppm/°C Max | -40°C to 125°C | LT1461DHS8-2.5 | LT1461DHS8-3 | LT1461DHS8-3.3 | LT1461DHS8-4 | LT1461DHS8-5 |

ELECTRICAL CHARACTERISTICS The ● denotes specifications which apply over the specified temperature range, otherwise specifications are at $T_A = 25^\circ\text{C}$. $V_{IN} - V_{OUT} = 0.5\text{V}$, Pin 3 = 2.4V, $C_L = 2\mu\text{F}$, unless otherwise specified.

| PARAMETER | CONDITIONS | MIN | TYP | MAX | UNITS |
|--|---|-------|------|------|--------------------------|
| Output Voltage (Note 4) | LT1461ACS8/LT1461AIS8 | -0.04 | | 0.04 | % |
| | LT1461BCS8/LT1461BIS8 | -0.06 | | 0.06 | % |
| | LT1461CCS8/LT1461CIS8 | -0.08 | | 0.08 | % |
| | LT1461DHS8 | -0.15 | | 0.15 | % |
| Output Voltage Temperature Coefficient (Note 5) | LT1461ACS8/LT1461AIS8 | ● | 1 | 3 | ppm/°C |
| | LT1461BCS8/LT1461BIS8 | ● | 3 | 7 | ppm/°C |
| | LT1461CCS8/LT1461CIS8 | ● | 5 | 12 | ppm/°C |
| | LT1461DHS8 | ● | 7 | 20 | ppm/°C |
| Line Regulation | $(V_{OUT} + 0.5\text{V}) \leq V_{IN} \leq 20\text{V}$ | ● | 2 | 8 | ppm/V |
| | LT1461DHS8 | ● | 15 | 50 | ppm/V |
| Load Regulation Sourcing (Note 6) | $V_{IN} = V_{OUT} + 2.5\text{V}$ $0 \leq I_{OUT} \leq 50\text{mA}$ | ● | 12 | 30 | ppm/mA |
| | LT1461DHS8, $0 \leq I_{OUT} \leq 10\text{mA}$ | ● | | 40 | ppm/mA |
| Dropout Voltage | $V_{IN} - V_{OUT}$, V_{OUT} Error = 0.1% | | | | |
| | $I_{OUT} = 0\text{mA}$ | | 0.06 | | V |
| | $I_{OUT} = 1\text{mA}$ | ● | 0.13 | 0.3 | V |
| | $I_{OUT} = 10\text{mA}$ | ● | 0.20 | 0.4 | V |
| | $I_{OUT} = 50\text{mA}$, I and C Grades Only | ● | 1.50 | 2.0 | V |
| Output Current | Short V_{OUT} to GND | | 100 | | mA |
| Shutdown Pin | Logic High Input Voltage | ● | 2.4 | | V |
| | Logic High Input Current, Pin 3 = 2.4V | ● | 2 | 15 | μA |
| | Logic Low Input Voltage | ● | | 0.8 | V |
| | Logic Low Input Current, Pin 3 = 0.8V | ● | 0.5 | 4 | μA |
| Supply Current | No Load | ● | 35 | 50 | μA |
| | | | | 70 | μA |
| Shutdown Current | $R_L = 1\text{k}$ | ● | 25 | 35 | μA |
| | | | | 55 | μA |
| Output Voltage Noise (Note 7) | $0.1\text{Hz} \leq f \leq 10\text{Hz}$ | | 8 | | ppm _{P-P} |
| | $10\text{Hz} \leq f \leq 1\text{kHz}$ | | 9.6 | | ppm _{RMS} |
| Long-Term Drift of Output Voltage, SO-8 Package (Note 8) | See Applications Information | | 60 | | ppm/ $\sqrt{\text{kHr}}$ |
| Thermal Hysteresis (Note 9) | $\Delta T = 0^\circ\text{C}$ to 70°C | | 40 | | ppm |
| | $\Delta T = -40^\circ\text{C}$ to 85°C | | 75 | | ppm |
| | $\Delta T = -40^\circ\text{C}$ to 125°C | | 120 | | ppm |

Note 1: Absolute Maximum Ratings are those values beyond which the life of a device may be impaired.

Note 2: The LT1461 is guaranteed functional over the operating temperature range of -40°C to 125°C .

Note 3: If the part is stored outside of the specified temperature range, or the junction temperature exceeds the specified temperature range, the output may shift due to hysteresis.

Note 4: ESD (Electrostatic Discharge) sensitive device. Extensive use of ESD protection devices are used internal to the LT1461, however, high electrostatic discharge can damage or degrade the device. Use proper ESD handling precautions.

Note 5: Temperature coefficient is calculated from the minimum and maximum output voltage measured at T_{MIN} , Room and T_{MAX} as follows:

$$TC = (V_{OMAX} - V_{OMIN}) / (T_{MAX} - T_{MIN})$$

Incremental slope is also measured at 25°C .

Note 6: Load regulation is measured on a pulse basis from no load to the specified load current. Output changes due to die temperature change must be taken into account separately.

Note 7: Peak-to-peak noise is measured with a single pole highpass filter at 0.1Hz and a 2-pole lowpass filter at 10Hz. The unit is enclosed in a still-air environment to eliminate thermocouple effects on the leads. The test time is 10 seconds. RMS noise is measured with a single pole highpass filter at 10Hz and a 2-pole lowpass filter at 1kHz. The resulting output is full-wave rectified and then integrated for a fixed period, making the final reading an average as opposed to RMS. A correction factor of 1.1 is used to convert from average to RMS and a second correction of 0.88 is used to correct for the nonideal bandpass of the filters.

ELECTRICAL CHARACTERISTICS

Note 8: Long-term drift typically has a logarithmic characteristic and therefore, changes after 1000 hours tend to be much smaller than before that time. Total drift in the second thousand hours is normally less than one third that of the first thousand hours with a continuing trend toward reduced drift with time. Long-term drift will also be affected by differential stresses between the IC and the board material created during board assembly. See the Applications Information section.

Note 9: Hysteresis in output voltage is created by package stress that depends on whether the IC was previously at a higher or lower temperature. Output voltage is always measured at 25°C, but the IC is cycled hot or cold before successive measurements. Hysteresis is roughly proportional to the square of the temperature change. Hysteresis is not normally a problem for operational temperature excursions where the instrument might be stored at high or low temperature. See Applications Information section.

TYPICAL PERFORMANCE CHARACTERISTICS

Characteristic curves are similar for most LT1461s. Curves from the LT1461-2.5 and the LT1461-5 represent the extremes of the voltage options. Characteristic curves for other output voltages fall between these curves and can be estimated based on their output.

2.5V Reference Voltage vs Temperature

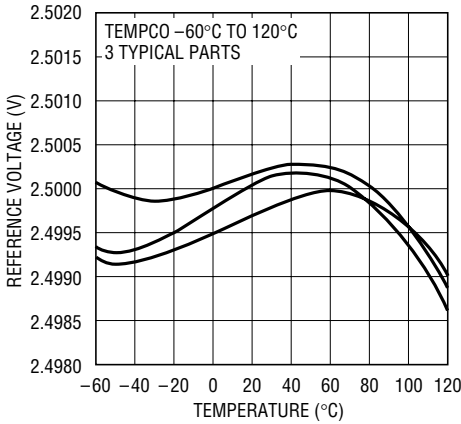

1461 G01

2.5V Load Regulation

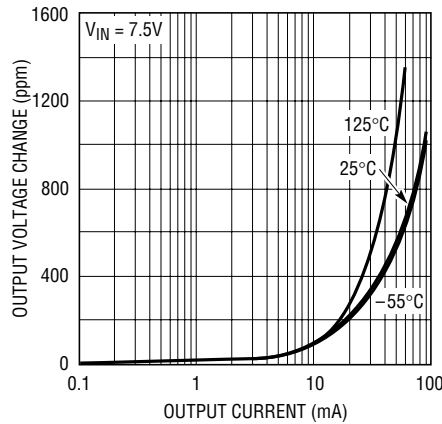

1461 G02

2.5V Line Regulation vs Temperature

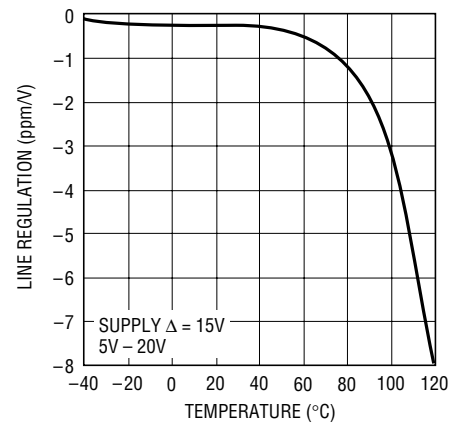

1461 G03

2.5V Minimum Input/Output Voltage Differential vs Load Current

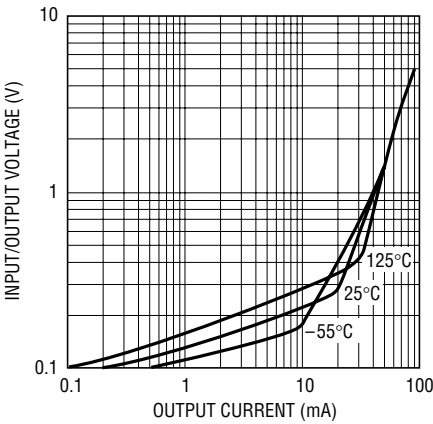

1461 G04

2.5V Supply Current vs Input Voltage

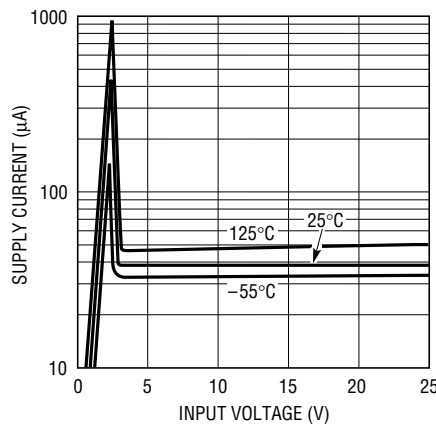

1461 G05

2.5V Ripple Rejection Ratio vs Frequency

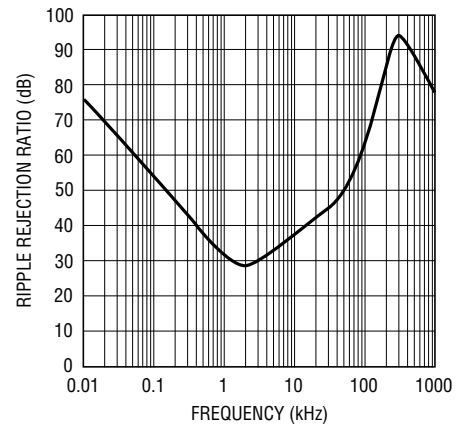

1461 G06

TYPICAL PERFORMANCE CHARACTERISTICS Characteristic curves are similar for most LT1461s. Curves from the LT1461-2.5 and the LT1461-5 represent the extremes of the voltage options. Characteristic curves for other output voltages fall between these curves and can be estimated based on their output.

2.5V Output Impedance vs Frequency

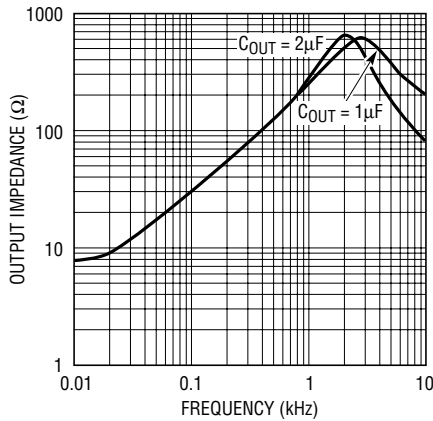

1461 G07

2.5V Turn-On Time

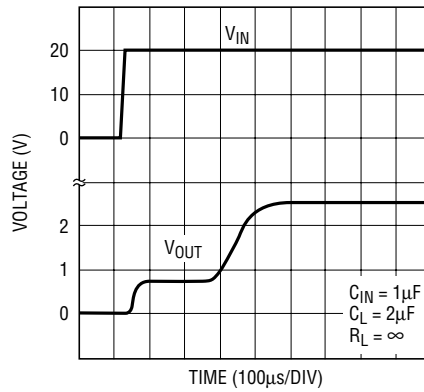

1461 G08

2.5V Turn-On Time

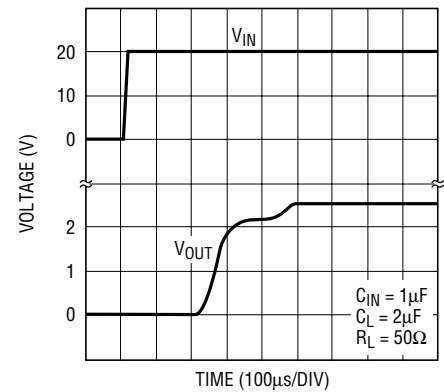

1461 G09

2.5V Transient Response to 10mA Load Step

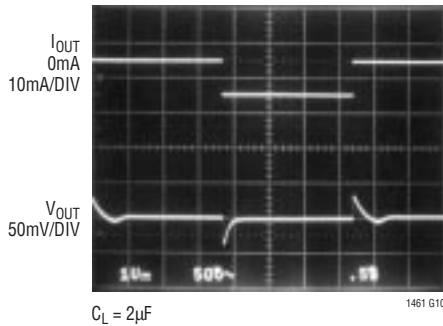

1461 G10

2.5V Line Transient Response

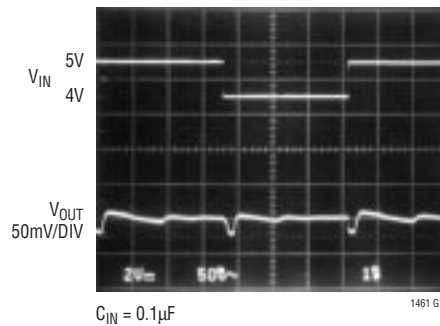

1461 G11

2.5V Output Noise
0.1Hz ≤ f ≤ 10Hz

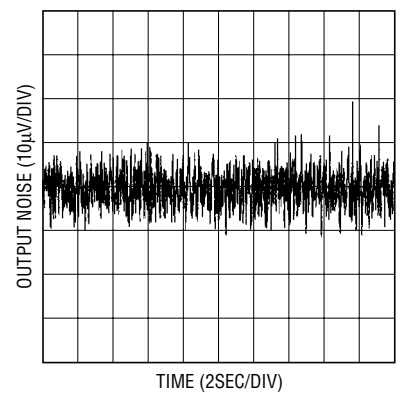

1461 G12

TYPICAL PERFORMANCE CHARACTERISTICS Characteristic curves are similar for most LT1461s. Curves from the LT1461-2.5 and the LT1461-5 represent the extremes of the voltage options. Characteristic curves for other output voltages fall between these curves and can be estimated based on their output.

5V Reference Voltage vs Temperature

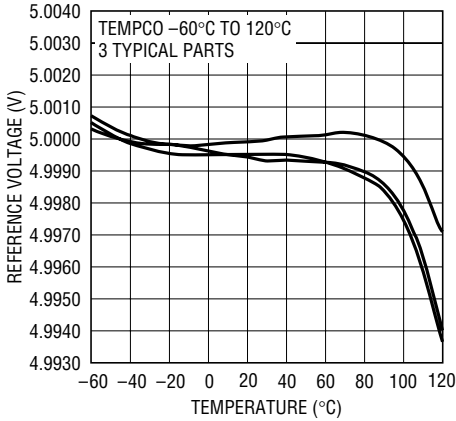

1461 G13

5V Load Regulation

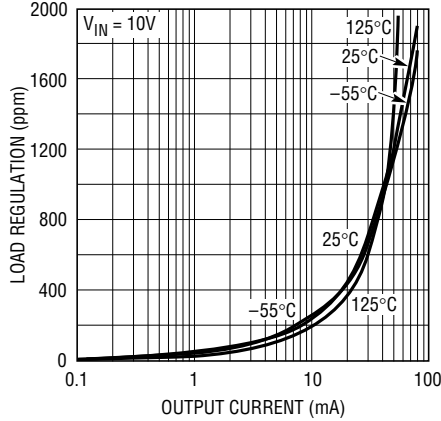

1461 G14

5V Line Regulation vs Temperature

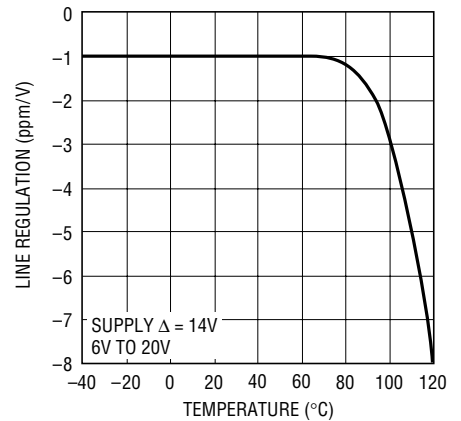

1461 G15

5V Minimum Input/Output Voltage Differential vs Load Current

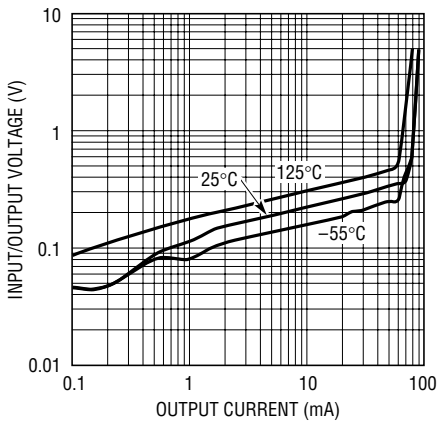

1461 G16

5V Supply Current vs Input Voltage

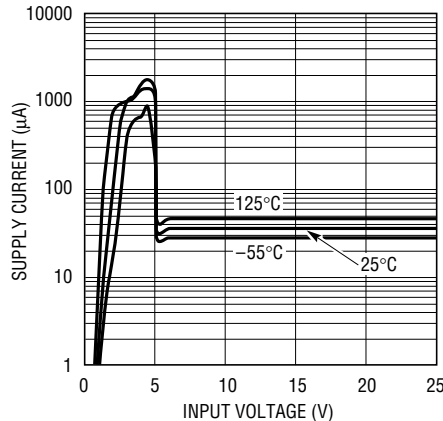

1461 G17

5V Ripple Rejection Ratio vs Frequency

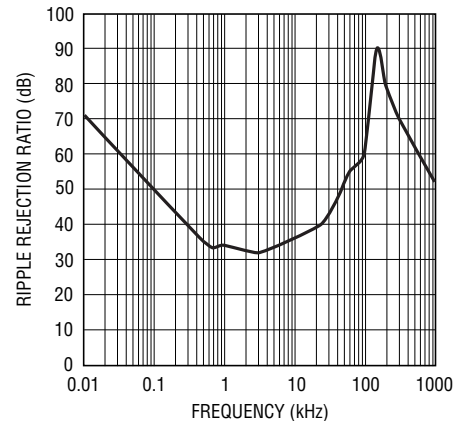

1461 G18

5V Output Impedance vs Frequency

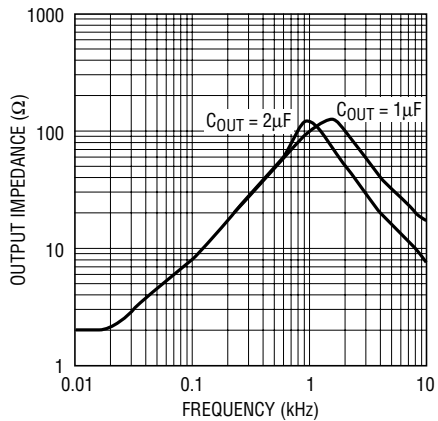

1461 G19

5V Turn-On Time

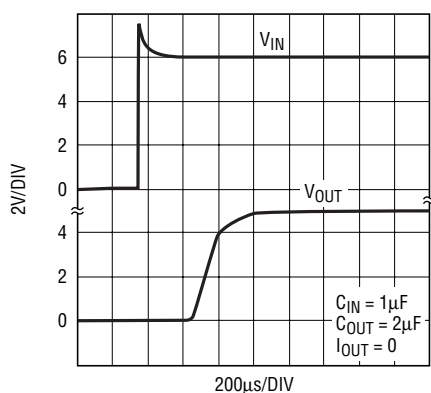

1461 G20

5V Turn-On Time

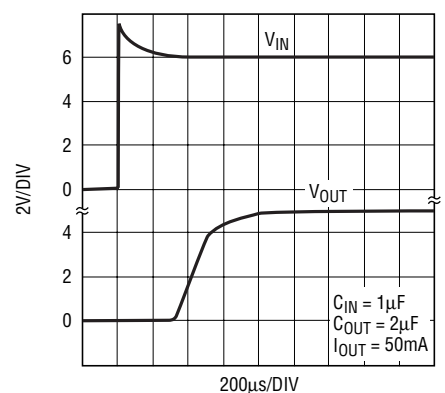

1461 G21

TYPICAL PERFORMANCE CHARACTERISTICS Characteristic curves are similar for most LT1461s. Curves from the LT1461-2.5 and the LT1461-5 represent the extremes of the voltage options. Characteristic curves for other output voltages fall between these curves and can be estimated based on their output.

5V Transient Response to 10mA Load Step

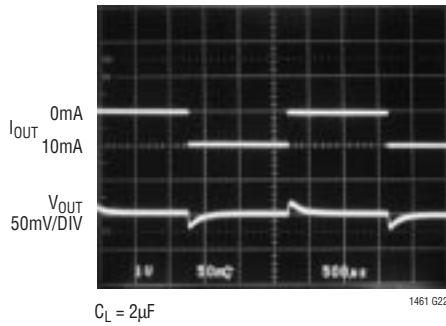

5V Line Transient Response

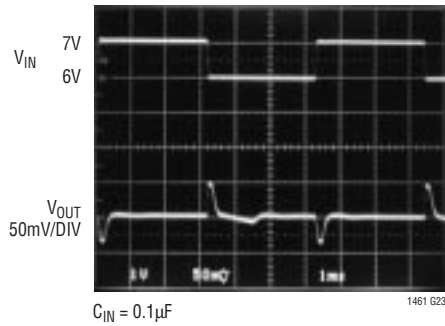

5V Output Noise
 $0.1\text{Hz} \leq f \leq 10\text{Hz}$

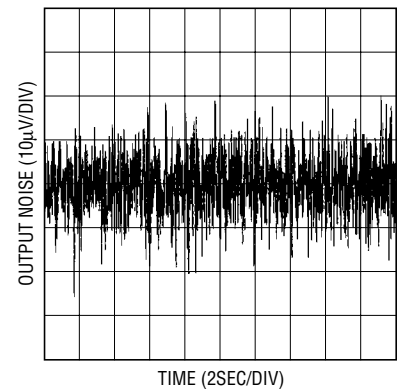

Supply Current vs Temperature

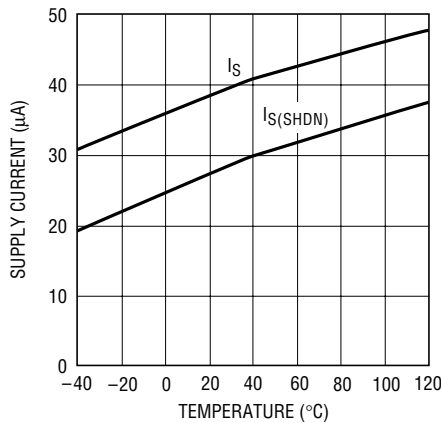

Current Limit vs Temperature

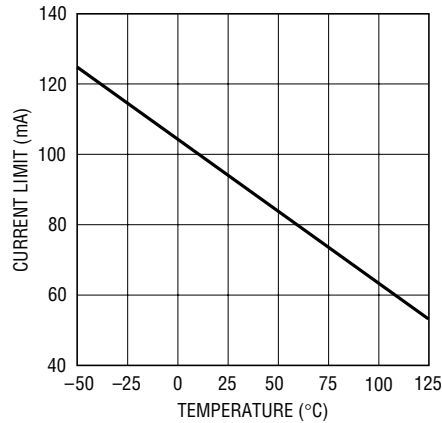

SHDN Pin Current vs SHDN Input Voltage

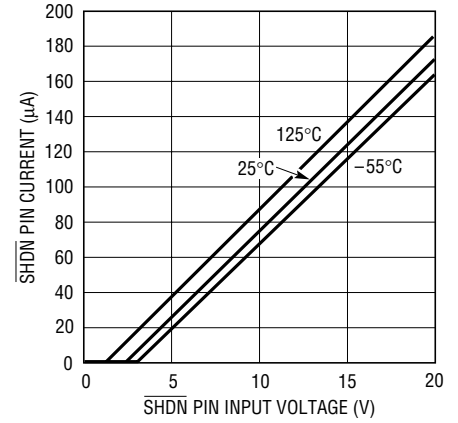

TYPICAL PERFORMANCE CHARACTERISTICS Characteristic curves are similar for most LT1461s. Curves from the LT1461-2.5 and the LT1461-5 represent the extremes of the voltage options. Characteristic curves for other output voltages fall between these curves and can be estimated based on their output.

0°C to 70°C Hysteresis

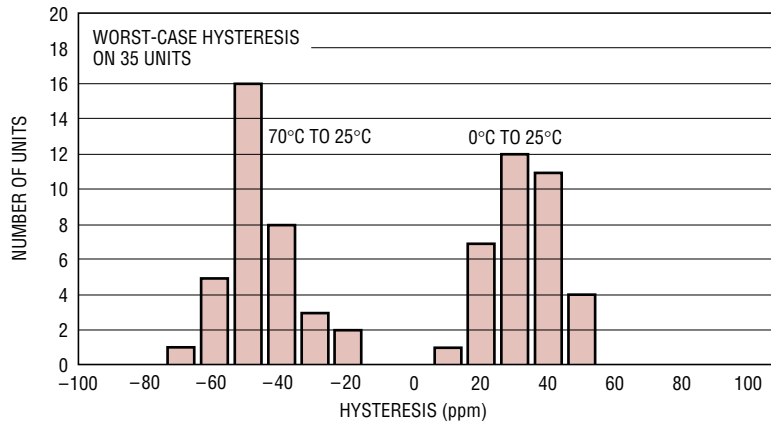

-40°C to 85°C Hysteresis

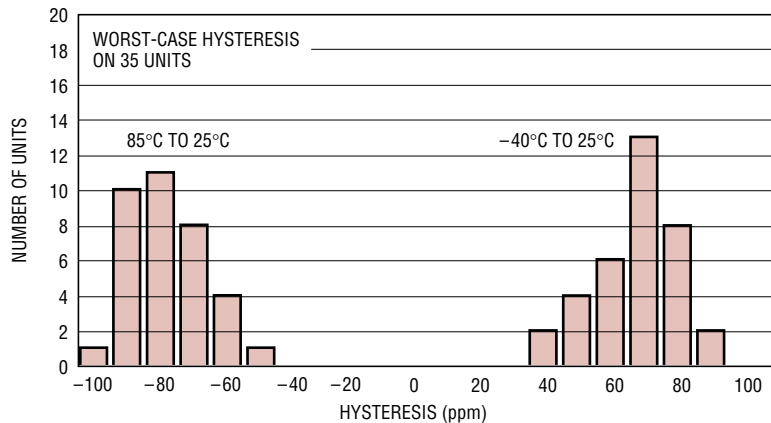

-40°C to 125°C Hysteresis

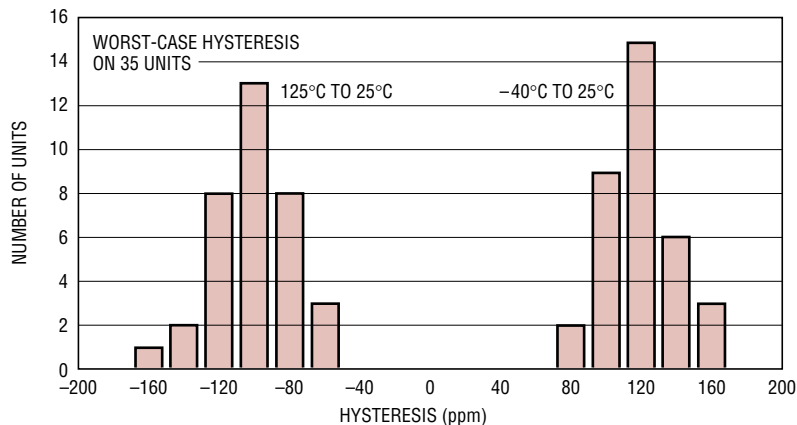

TYPICAL PERFORMANCE CHARACTERISTICS Characteristic curves are similar for most LT1461s. Curves from the LT1461-2.5 and the LT1461-5 represent the extremes of the voltage options. Characteristic curves for other output voltages fall between these curves and can be estimated based on their output.

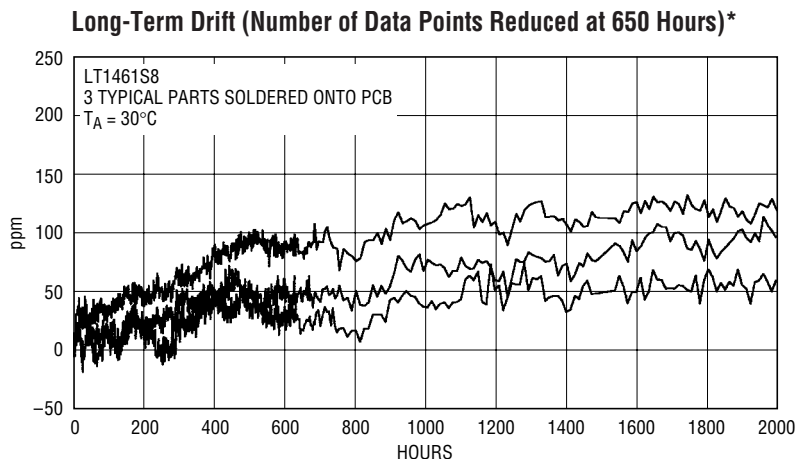

*SEE APPLICATIONS INFORMATION FOR DETAILED EXPLANATION OF LONG-TERM DRIFT

APPLICATIONS INFORMATION

Examples shown in this Applications section use the LT1461-2.5. The response of other voltage options can be estimated by proper scaling.

Bypass and Load Capacitors

The LT1461 family requires a capacitor on the input and on the output for stability. The capacitor on the input is a supply bypass capacitor and if the bypass capacitors from other components are close (within 2 inches) they

should be sufficient. The output capacitor acts as frequency compensation for the reference and cannot be omitted. For light loads $\leq 1\text{mA}$, a $1\mu\text{F}$ nonpolar output capacitor is usually adequate, but for higher loads (up to 75mA), the output capacitor should be $2\mu\text{F}$ or greater. Figures 1 and 2 show the transient response to a 1mA load step with a $1\mu\text{F}$ output capacitor and a 50mA load step with a $2\mu\text{F}$ output capacitor.

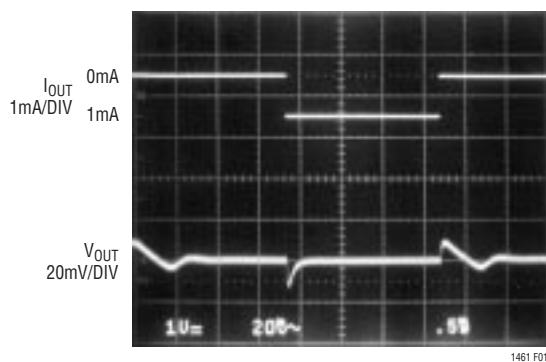

Figure 1. 1mA Load Step with C_L = 1μF

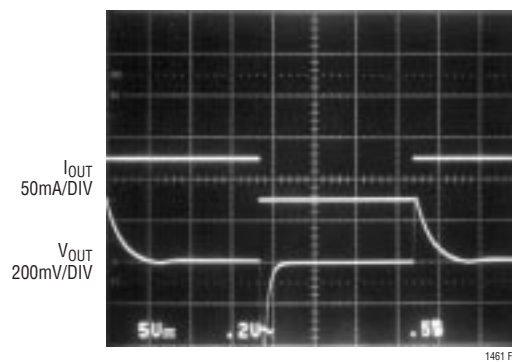

Figure 2. 50mA Load Step with C_L = 2μF

APPLICATIONS INFORMATION

Precision Regulator

The LT1461 will deliver 50mA with $V_{IN} = V_{OUT} + 2.5V$ and higher load current with higher V_{IN} . Load regulation is typically 12ppm/mA, which means for a 50mA load step, the output will change by only 1.5mV. Thermal regulation, caused by die temperature gradients and created from load current or input voltage changes, is not measurable. This often overlooked parameter must be added to normal line and load regulation errors. The load regulation photo, on the first page of this data sheet, shows the output response to 200mW of instantaneous power dissipation and the reference shows no sign of thermal errors. The reference has thermal shutdown and will turn off if the junction temperature exceeds 150°C.

Shutdown

The shutdown (Pin 3 low) serves to shut off load current when the LT1461 is used as a regulator. The LT1461 operates normally with Pin 3 open or greater than or equal to 2.4V. In shutdown, the reference draws a maximum supply current of 35µA. Figure 3 shows the transient response of shutdown while the part is delivering 25mA. After shutdown, the reference powers up in about 200µs.

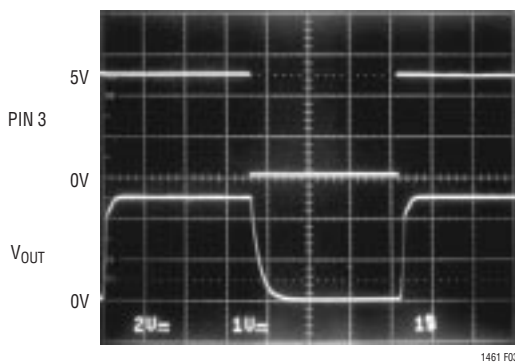

Figure 3. Shutdown While Delivering 25mA, $R_L = 100\Omega$

PC Board Layout

In 13- to 16-bit systems where initial accuracy and temperature coefficient calibrations have been done, the mechanical and thermal stress on a PC board (in a card cage for instance) can shift the output voltage and mask the true temperature coefficient of a reference. In addition, the mechanical stress of being soldered into a PC board can cause the output voltage to shift from its ideal value. Surface mount voltage references are the most susceptible to PC board stress because of the small amount of plastic used to hold the lead frame.

A simple way to improve the stress-related shifts is to mount the reference near the short edge of the PC board, or in a corner. The board edge acts as a stress boundary, or a region where the flexure of the board is minimum. The package should always be mounted so that the leads absorb the stress and not the package. The package is generally aligned with the leads parallel to the long side of the PC board as shown in Figure 5a.

A qualitative technique to evaluate the effect of stress on voltage references is to solder the part into a PC board and deform the board a fixed amount as shown in Figure 4. The flexure #1 represents no displacement, flexure #2 is concave movement, flexure #3 is relaxation to no displacement and finally, flexure #4 is a convex movement. This motion is repeated for a number of cycles and the

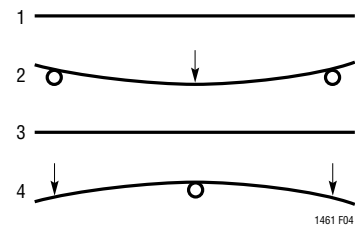

Figure 4. Flexure Numbers

APPLICATIONS INFORMATION

relative output deviation is noted. The result shown in Figure 5a is for two LT1461S8-2.5s mounted vertically and Figure 5b is for two LT1461S8-2.5s mounted horizontally. The parts oriented in Figure 5a impart less stress into the package because stress is absorbed in the leads. Figures 5a and 5b show the deviation to be between $125\mu\text{V}$ and $250\mu\text{V}$ and implies a 50ppm and 100ppm change respectively. This corresponds to a 13- to 14-bit system and is not a problem for most 10- to 12-bit systems unless the system has a calibration. In this case, as with temperature hysteresis, this low level can be important and even more careful techniques are required.

The most effective technique to improve PC board stress is to cut slots in the board around the reference to serve as a strain relief. These slots can be cut on three sides of the reference and the leads can exit on the fourth side. This “tongue” of PC board material can be oriented in the long direction of the board to further reduce stress transferred to the reference.

The results of slotting the PC boards of Figures 5a and 5b are shown in Figures 6a and 6b. In this example the slots can improve the output shift from about 100ppm to nearly zero.

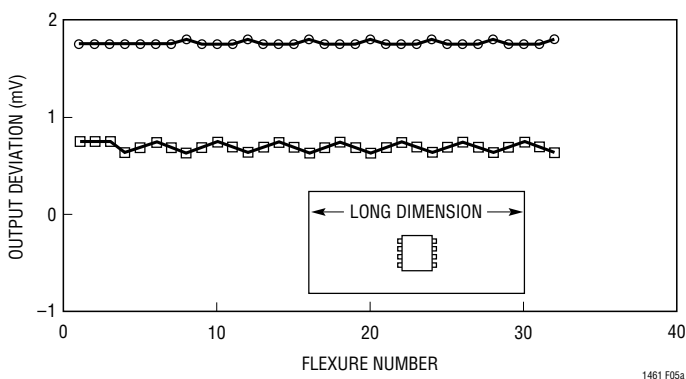

Figure 5a. Two Typical LT1461S8-2.5s, Vertical Orientation Without Slots

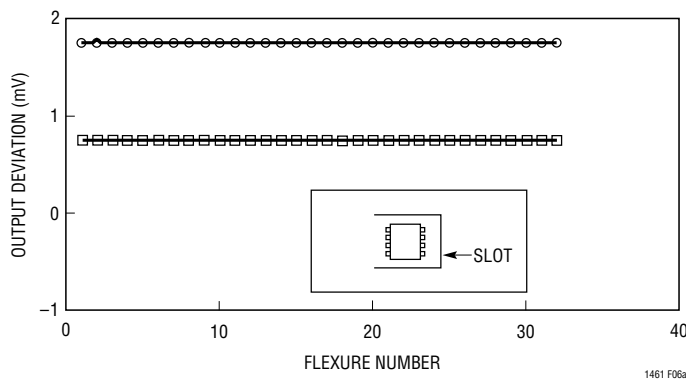

Figure 6a. Same Two LT1461S8-2.5s in Figure 5a, but with Slots

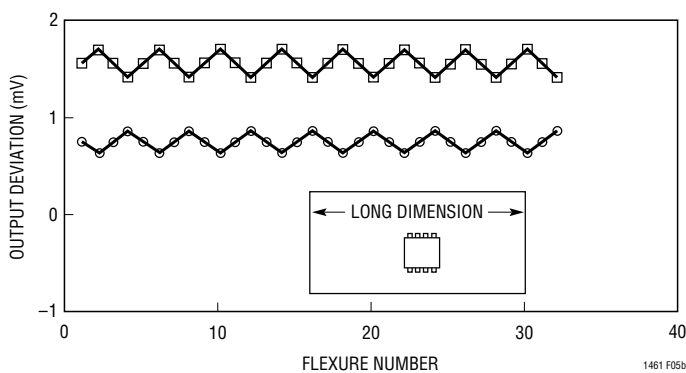

Figure 5b. Two Typical LT1461S8-2.5s, Horizontal Orientation Without Slots

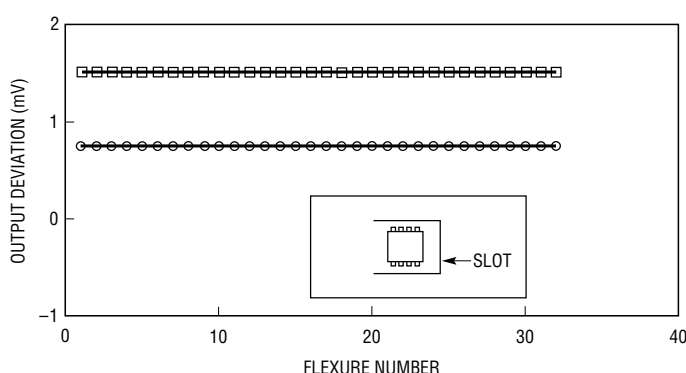

Figure 6b. Same Two LT1461S8-2.5s in Figure 5b, but with Slots

APPLICATIONS INFORMATION

Long-Term Drift

Long-term drift cannot be extrapolated from accelerated high temperature testing. This erroneous technique gives drift numbers that are wildly optimistic. The only way long-term drift can be determined is to measure it over the time interval of interest. The erroneous technique uses the Arrhenius Equation to derive an acceleration factor from elevated temperature readings. The equation is:

$$A_F = e^{\frac{E_A}{K} \left(\frac{1}{T_1} - \frac{1}{T_2} \right)}$$

where: E_A = Activation Energy (Assume 0.7)

K = Boltzmann's Constant

T_2 = Test Condition in °Kelvin

T_1 = Use Condition Temperature in °Kelvin

To show how absurd this technique is, compare the LT1461 data. Typical 1000 hour long-term drift at 30°C = 60ppm. The typical 1000 hour long-term drift at 130°C = 120ppm. From the Arrhenius Equation the acceleration factor is:

$$A_F = e^{0.0000863 \left(\frac{1}{303} - \frac{1}{403} \right)} = 767$$

The erroneous projected long-term drift is:

$$120\text{ppm}/767 = 0.156\text{ppm}/1000 \text{ hr}$$

For a 2.5V reference, this corresponds to a 0.39µV shift after 1000 hours. This is pretty hard to determine (read impossible) if the peak-to-peak output noise is larger than this number. As a practical matter, one of the best laboratory references available is the Fluke 732A and its long-term drift is 1.5µV/mo. This performance is only available from the best subsurface zener references utilizing specialized heater techniques.

The LT1461 long-term drift data was taken with parts that were soldered onto PC boards similar to a "real world" application. The boards were then placed into a constant temperature oven with $T_A = 30^\circ\text{C}$, their outputs were

scanned regularly and measured with an 8.5 digit DVM. As an additional accuracy check on the DVM, a Fluke 732A laboratory reference was also scanned. Figure 7 shows the long-term drift measurement system. The data taken is shown at the end of the Typical Performance Characteristics section of this data sheet. The long-term drift is the trend line that asymptotes to a value at 2000 hours. Note the slope in output shift between 0 hours and 1000 hours compared to the slope between 1000 hours and 2000 hours. Long-term drift is affected by differential stresses between the IC and the board material created during board assembly.

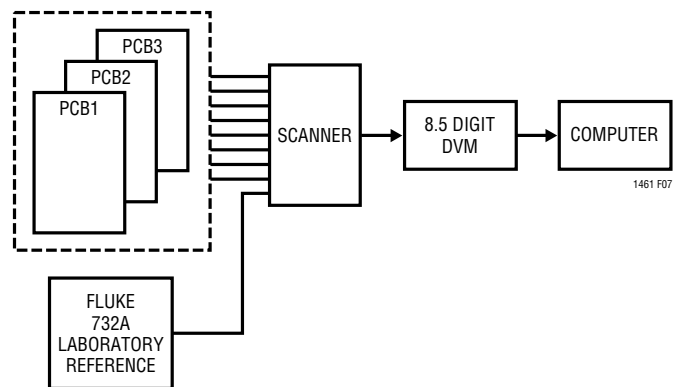

Figure 7. Long-Term Drift Measurement Setup

Hysteresis

The hysteresis curves found in the Typical Performance Characteristics represent the worst-case data taken on 35 typical parts after multiple temperature cycles. As expected, the parts that are cycled over the wider -40°C to 125°C temperature range have more hysteresis than those cycled over lower ranges. Note that the hysteresis coming from 125°C to 25°C has an influence on the -40°C to 25°C hysteresis. The -40°C to 25°C hysteresis is different depending on the part's previous temperature. This is because not all of the high temperature stress is relieved during the 25°C measurement.

The typical performance hysteresis curves are for parts mounted in a socket and represent the performance of the

APPLICATIONS INFORMATION

parts alone. What is more interesting are parts IR soldered onto a PC board. If the PC board is then temperature cycled several times from -40°C to 85°C , the resulting hysteresis curve is shown in Figure 8. This graph shows the influence of the PC board stress on the reference.

When the LT1461 is soldered onto a PC board, the output shifts due to thermal hysteresis. Figure 9 shows the effect of soldering 40 pieces onto a PC board using standard IR reflow techniques. The average output voltage shift is -110ppm . Remeasurement of these parts after 12 days shows the outputs typically shift back 45ppm toward their initial value. This second shift is due to the relaxation of stress incurred during soldering.

The LT1461 is capable of dissipating high power, i.e., for the LT1461-2.5, $17.5\text{V} \cdot 50\text{mA} = 875\text{mW}$. The SO-8 package has a thermal resistance of $190^{\circ}\text{C}/\text{W}$ and this dissipation causes a 166°C internal rise producing a junction temperature of $T_J = 25^{\circ}\text{C} + 166^{\circ}\text{C} = 191^{\circ}\text{C}$. What will actually occur is the thermal shutdown will limit the junction temperature to around 150°C . This high temperature excursion will cause the output to shift due to thermal hysteresis. Under these conditions, a typical output shift is -135ppm , although this number can be higher. This high dissipation can cause the 25°C output accuracy to exceed its specified limit. **For best accuracy and precision, the LT1461 junction temperature should not exceed 125°C .**

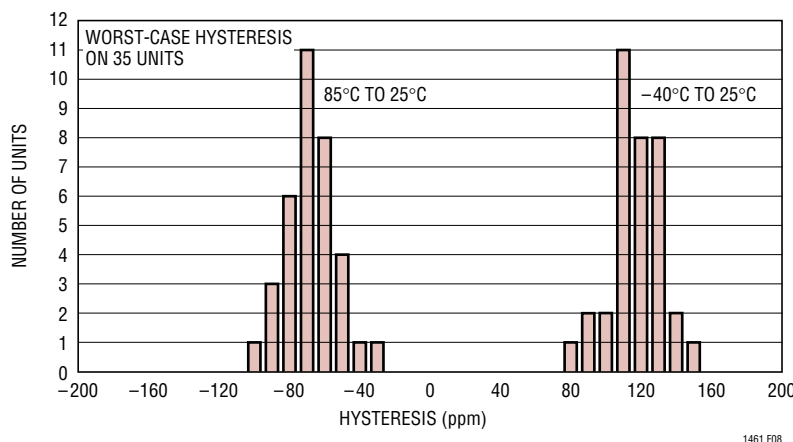

Figure 8. -40°C to 85°C Hysteresis of 35 Parts Soldered Onto a PC Board

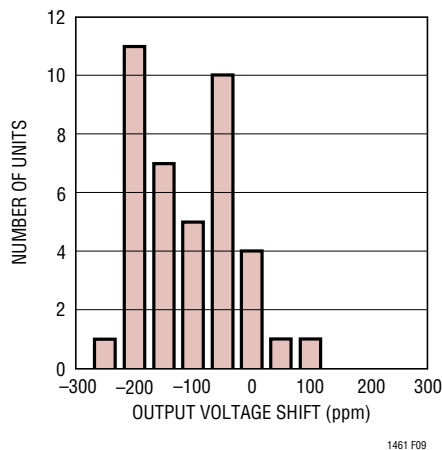
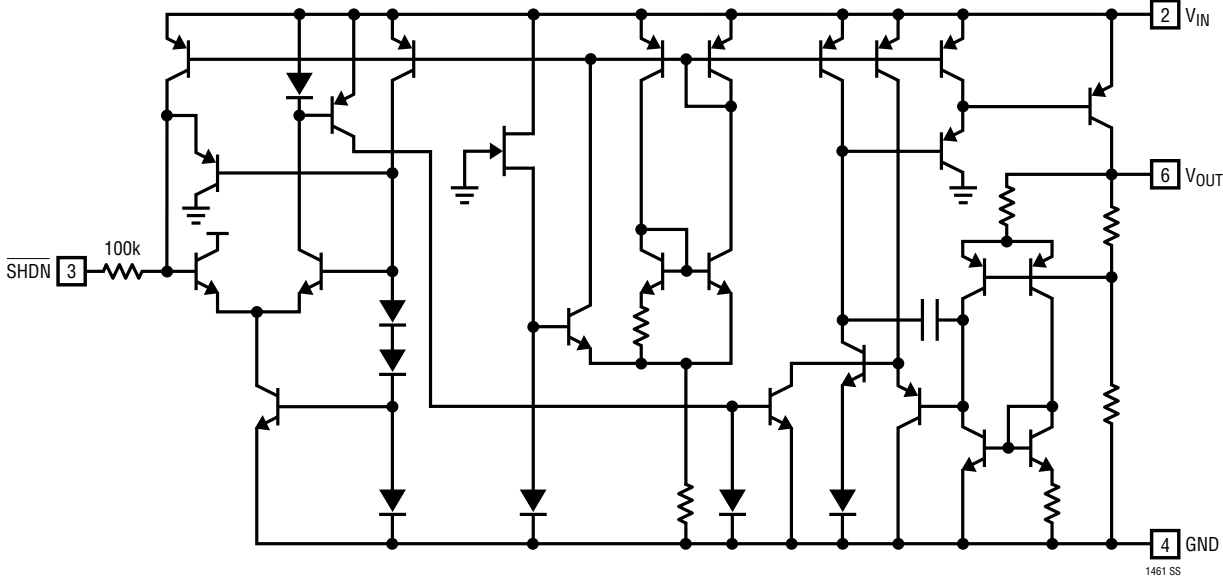

Figure 9. Typical Distribution of Output Voltage Shift After Soldering Onto PC Board

SIMPLIFIED SCHEMATIC



PACKAGE DESCRIPTION Dimensions in inches (millimeters) unless otherwise noted.

S8 Package
8-Lead Plastic Small Outline (Narrow 0.150)
 (LTC DWG # 05-08-1610)

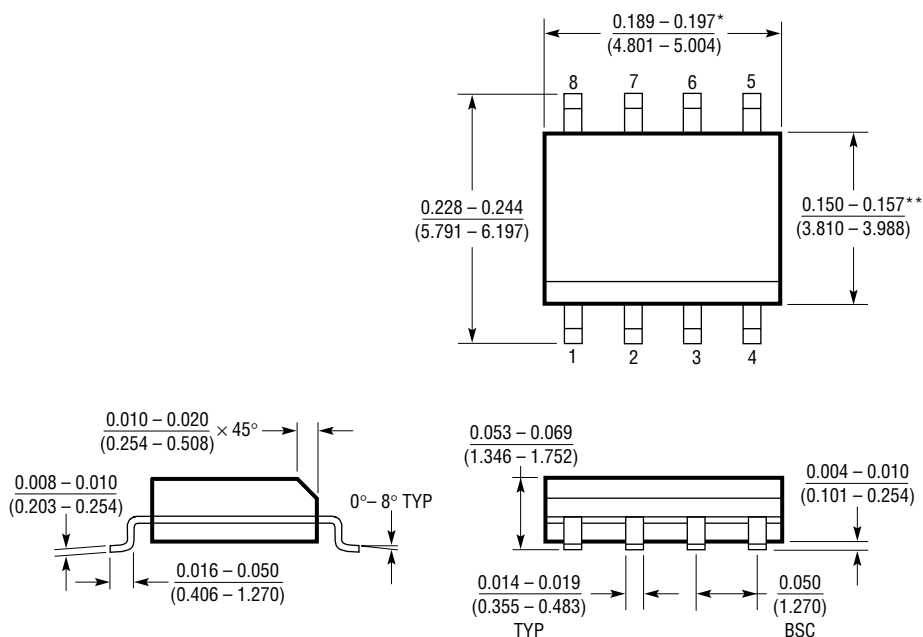

*DIMENSION DOES NOT INCLUDE MOLD FLASH. MOLD FLASH SHALL NOT EXCEED 0.006" (0.152mm) PER SIDE
 **DIMENSION DOES NOT INCLUDE INTERLEAD FLASH. INTERLEAD FLASH SHALL NOT EXCEED 0.010" (0.254mm) PER SIDE

S08 1298

TYPICAL APPLICATION

Low Power 16-Bit A/D

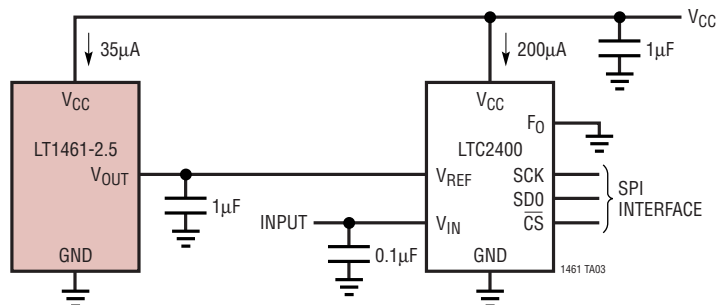

NOISE PERFORMANCE*

$V_{IN} = 0V, V_{NOISE} = 1.1ppm_{RMS} = 2.25\mu V_{RMS} = 16\mu V_{P-P}$
 $V_{IN} = V_{REF}/2, V_{NOISE} = 1.6ppm_{RMS} = 4\mu V_{RMS} = 24\mu V_{P-P}$
 $V_{IN} = V_{REF}, V_{NOISE} = 2.5ppm_{RMS} = 6.25\mu V_{RMS} = 36\mu V_{P-P}$

*FOR 24-BIT PERFORMANCE USE LT1236 REFERENCE

RELATED PARTS

| PART NUMBER | DESCRIPTION | COMMENTS |
|-------------|--|---|
| LT1019 | Precision Reference | Bandgap, 0.05%, 5ppm/°C |
| LT1027 | Precision 5V Reference | Lowest TC, High Accuracy, Low Noise, Zener Based |
| LT1236 | Precision Reference | 5V and 10V Zener-Based 5ppm/°C, SO-8 Package |
| LTC®1798 | Micropower Low Dropout Reference | 0.15% Max, 6.5µA Supply Current |
| LT1460 | Micropower Precision Series Reference | Bandgap, 130µA Supply Current 10ppm/°C, Available in SOT-23 |
| LT1634 | Micropower Precision Shunt Voltage Reference | Bandgap 0.05%, 10ppm/°C, 10µA Supply Current |
| LT1790 | Precision SOT-23 Series Reference | Bandgap 0.05% Max, 10ppm/°C Max |