



Power MOSFETs for Automotive Applications

Performance, quality, reliability



Automotive Power MOSFETs



NXP offers a highly flexible approach to power design for automotive systems.

NXP is a global leader in the area of discrete power MOSFETs for automotive systems. An in-depth understanding of automotive applications means NXP can deliver power semiconductor solutions from its wide range of standard products or its capability to create unique custom offerings to meet customer specific requirements.

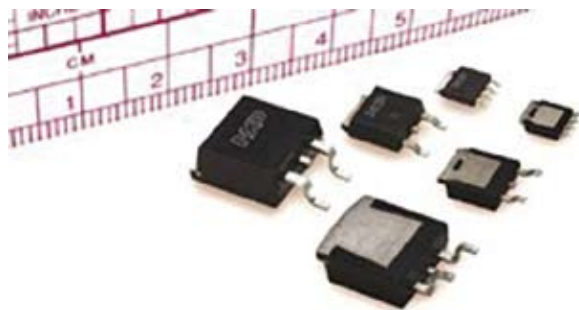

From driving a simple lamp to the sophisticated needs of power control in engine, body or chassis applications, NXP power semiconductors are the common answer to many automotive system power problems.

Our automotive power portfolio draws on a clear technology focus and NXP is committed to developing this technology in direct alignment with the needs of leading automotive systems suppliers worldwide.

NXP's development, technical support and marketing teams make for the highest level of service required to support the automotive market with solutions to power control system problems.

By providing a complete technology, device and service capability NXP helps you meet the diverse and rigorous technical demands of today's automotive power switching and control applications, driving the development of tomorrow's cars and keeping you ahead of the rest.

The automotive environment has always been a physical challenge, but developing ecological and commercial constraints need ever more ingenious and innovative solutions, which NXP is committed to providing.

Simply, NXP gives you the power to meet the challenges of individual system design, every step of the way.

Quality and reliability

The quality performance of NXP Power MOSFETs targets the Zero Defects expectation of automotive customers, achieving field return rates below 1ppm.

This standard has been achieved through many years of proven manufacturing quality and continuous improvement initiatives.

The fundamental TrenchMOS building blocks are mature technologies, used in NXP's automotive products since as early as 1998.

Ongoing improvement processes are applied from diffusion, with increased automation and particle reduction activities, right through the entire manufacturing process to final assembly where enhanced test regimes also serve to ensure the highest possible product quality.

NXP automotive power solutions

Global leadership	<ul style="list-style-type: none"> ▶ Worldwide supplier of discrete power MOSFETs for automotive systems ▶ Close alignment with automotive partners
Wide selection	<ul style="list-style-type: none"> ▶ Standard products for a wide range of applications ▶ Unique, made-to-order solutions for high-volume applications
Leading-edge technology	<ul style="list-style-type: none"> ▶ Pioneer in TrenchMOS ▶ Supplier of TrenchPLUS, with integrated sensor capabilities
Innovative packaging	<ul style="list-style-type: none"> ▶ LFPACK for outstanding thermal performance, package resistance, and reliability ▶ Known Good Die (KGD) program for high-quality bare die
Highest standards for quality and reliability	<ul style="list-style-type: none"> ▶ Design for excellence approach ▶ Zero Defects Program ▶ AEC-Q101 qualified MOSFETs ▶ ISO/TS 16949:2002 plant certification

LFAK

LFAK (SOT669) for high-density applications

NXP MOSFETs housed in the compact, thermally-enhanced Loss Free PACkage (LFAK) are optimized for high-density automotive applications. LFAK delivers the ultimate combination with ultra-low package resistance, superior reliability and thermal performance. All this in a very small package that ensures you can put power where you need it most, anywhere in the car.

In automotive systems space is becoming a key issue, especially under the hood. Today's MOSFETs need to provide the absolute best thermal performance possible to enable switching of loads requiring significant currents. In answer to this, NXP has introduced the LFAK to ensure a superior level of on-resistance and thermal performance in an extremely compact housing. The combination of NXP's TrenchMOS technology and LFAK delivers compact power to many applications that previously were limited to only large discrete power packages.

The LFAK's copper source clip design overcomes the limitations of the standard SO8, resulting in thermal resistances comparable to that of bigger packages such as DPAK. In a traditional power package the main thermal pathway is vertically down through the mounting and into the PCB. However, the LFAK also conducts a significant amount of heat upwards and out through the source lead.

Fully qualified to meet the rigorous demands of the AEC-Q101 standard for discrete devices, these new products are aimed at a variety of applications where size, thermal performance and low cost manufacturing processes are critical design considerations.

Real-estate benefits of using LFAK

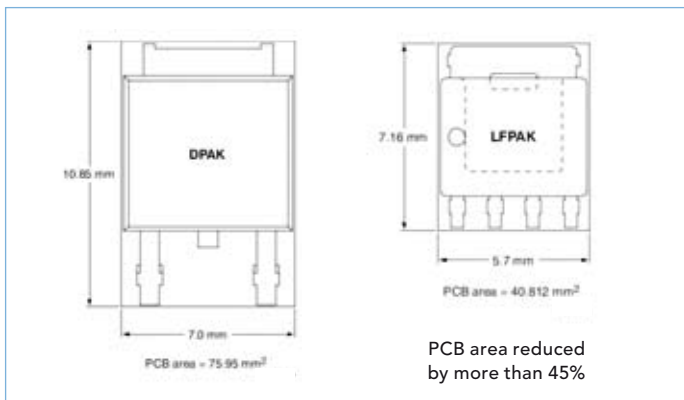

Key benefits:

- ▶ Low inductance
- ▶ Low thermal resistance
- ▶ Dimensions comparable to SO8
- ▶ Significantly thinner than SO8 & DPAK
- ▶ Wirebond free - Cu clip design
- ▶ High current transient robustness
- ▶ Avalanche Robust up to $T_j(\text{max})$
- ▶ 100% avalanche tested
- ▶ Automotive AEC-Q101 qualified to 175 °C
- ▶ Leads are optical-inspection friendly



Target applications for LFAK products

- ▶ Engine and transmission controllers
- ▶ Advanced braking systems
- ▶ Coolant pumps
- ▶ DC-DC converters
- ▶ Reverse battery protection
- ▶ General-purpose automotive switching where space is at a premium

Comparison between typical wirebonds and clip design

Package	Lead/Wire Res (mΩ)
LFAK	0.31
DPAK*	2.21

*1 x 300 μm bond wire

LFAK thermal conduction

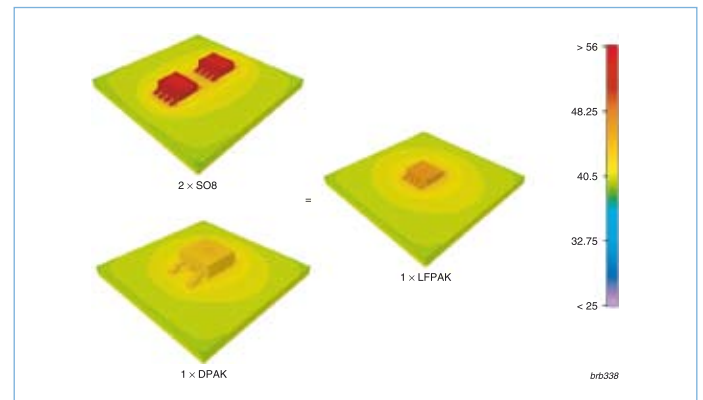
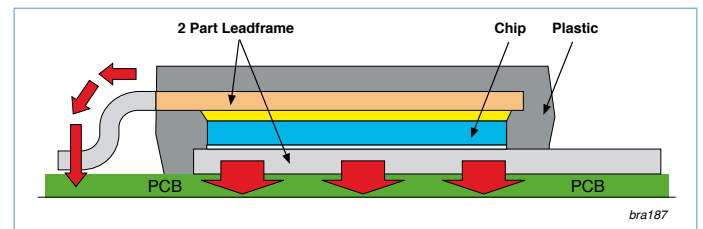

LFAK case temperature is significantly lower than two SO8 packages, and similar to single DPAK (1 W power dissipation on all three packages)

KGD program

KGD for high-current & high-temperature applications

NXP's Known Good Die (KGD) technology overcomes the inspection and testing issues traditionally associated with the bare-die, wafer-based products typically needed for high-current and high-temperature applications.

NXP's specialized process first singulates the wafer into individual dice, then subjects each one to a rigorous test and inspection before final packaging into tape & reel format, ensuring the highest possible product quality.

KGD technology enables custom mounting and bonding for maximum contact with the die, significantly reducing $R_{DS(ON)}$ and offering greatly reduced thermal resistance due to the optimized thermal path to the heatsink. Free of the limitations of standard packaging KGD also offers both high-current (>200 A typ) and high-temperature (>175 °C typ) operation.

This state-of-the-art technology offers a cost-effective solution in parallel configuration, for example, in hybrid modules where space is at a premium.

NXP's KGD program is well established and offers large-scale production capacity. In addition to a wide choice of existing products NXP also supports custom KGD designs to meet specific requirements. Delivering the highest levels of quality and reliability, all the products in the KGD portfolio are qualified to the AEC-Q101 standard.

Target applications for KGD products

- ▶ Advanced power-steering modules
- ▶ Advanced braking systems
- ▶ Coolant pumps
- ▶ Hybrid vehicles (with integrated and non-integrated stop/start solutions)
- ▶ Engine and transmission controllers

KGD Features and Benefits

Testing	<ul style="list-style-type: none"> ▶ Customized probe cards with a single clamping mechanism ensure maximum die contact with minimal mechanical handling ▶ Singulated die electrically tested twice to guarantee datasheet specifications ▶ Dynamic PAT/SYA to guarantee the removal of abnormal devices ▶ High-current avalanche ruggedness testing
Inspection	<ul style="list-style-type: none"> ▶ Automatic optical inspection pre- and post-singulation to reduce process and handling imperfections
Die & packaging	<ul style="list-style-type: none"> ▶ Die sizes ranging from 2.4 to 58 mm² ▶ Dry-packed tape-and-reel delivery format

Test	Sawn Wafer	NXP KGD
High-current test	No	Yes
Ruggedness test	No	Yes
Percentage test	100 (preset)	200 (T1, T2)
Visually inspected	Yes (manual)	Yes (auto optical)
Test after singulation	No	Yes
Possibility of die scratching after test	Higher	Lower

KGD test nest*

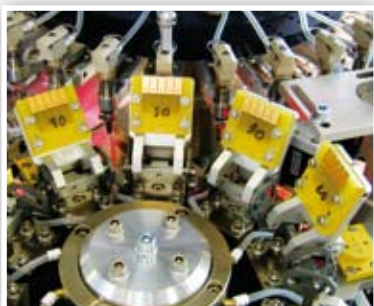

Visual inspection & test system*







Delivery on tape and reel



*Courtesy of Ismeca SA

Selection Guides

30 V N-channel Automotive TrenchMOS





R _{DSon} (max) @10 V (mΩ)	R _{DSon} (max) @5 V (mΩ)	I _D (max) @25 °C (A)	R _{th(j-mb)} (max) (K/W)	3-lead TO-220AB (SOT78A)	I2PAK (SOT226)	D2PAK (SOT404)	DPAK (SOT428)	LPAK (SOT669)
								
				15.5 x 10.0 x 4.3	11.0 x 10.0 x 4.3	11.0 x 10.0 x 4.3	6.0 x 6.6 x 2.3	3.95 x 4.9 x 1.1
1.5		100	0.45			<u>BUK661R5-30C</u>		
1.7			0.45	<u>BUK651R7-30C⁽¹⁾</u>	<u>BUK6E1R7-30C</u>			
1.8		100	0.45			BUK761R8-30C		
1.8		100	0.57			<u>BUK661R8-30C</u>		
2.1			0.59	<u>BUK652R1-30C⁽¹⁾</u>				
2.4	2.8	75	0.5	BUK952R8-30B		BUK962R8-30B		
2.5			0.74			<u>BUK662R5-30C</u>		
2.7		75	0.5	BUK752R7-30B	BUK7E2R7-30B	BUK762R7-30B		
2.7			0.74	<u>BUK652R7-30C⁽¹⁾</u>				
3	4	75	0.59		BUK9E04-30B			
3.4		75	0.59	BUK753R4-30B		BUK763R4-30B		
3.5			0.95			<u>BUK663R5-30C</u>		
3.7			0.95	<u>BUK653R7-30C⁽¹⁾</u>				
4.2	7	75	1.42					<u>BUK9Y07-30B</u>
4.5		75	0.95				<u>BUK724R5-30C</u>	
4.6	5	75	0.65	BUK9505-30A		BUK9605-30A		
5	7	75	0.95	BUK9507-30B		BUK9607-30B	BUK9207-30B	
7		75	1.42					<u>BUK7Y07-30B</u>
7		75	0.95	BUK7507-30B		BUK7607-30B	BUK7207-30B	
9	11	59	2					BUK9Y11-30B
10		66	1.76					<u>BUK7Y10-30B</u>
11	13	75	1				BUK9213-30A	
12	14	63	1.4				BUK9214-30A	
13		55	1.4				BUK6213-30A	
13.7	22	37	2.53					<u>BUK9Y22-30B</u>
20		39	2.53					<u>BUK7Y20-30B</u>

Types in **bold red** represent new products

Types in **bold red italic underline** represent products in development

⁽¹⁾ these products use SOT78B package

40 V N-channel Automotive TrenchMOS

$R_{DS(on)}$ (max) @10 V (m Ω)	$R_{DS(on)}$ (max) @5 V (m Ω)	I_D (max) @25 °C (A)	$R_{th(j-mb)}$ (max) (K/W)	3-lead TO-220AB (SOT78A)	I2PAK (SOT226)	D2PAK (SOT404)	DPAK (SOT428)	LFAK (SOT669)
								
				15.5 x 10.0 x 4.3	11.0 x 10.0 x 4.3	11.0 x 10.0 x 4.3	6.0 x 6.6 x 2.3	3.95 x 4.9 x 1.1
1.9		100	0.45			<i>BUK661R9-40C</i>		
2		100	0.45	<i>BUK652R0-40C</i> ^[1]	<i>BUK6E2R0-40C</i>	BUK762R0-40C		
2.3		100	0.45	BUK752R3-40C	BUK7E2R3-40C			
2.4			0.59			<i>BUK662R4-40C</i>		
2.6		100	0.59	<i>BUK652R6-40C</i> ^[1]				
2.8	3.2	100	0.5	BUK953R2-40B	BUK9E3R2-40B	BUK963R2-40B		
3.1		75	0.5	BUK753R1-40B		BUK763R1-40B		
3.2		100	0.74			<i>BUK663R2-40C</i>		
3.4		100	0.74	<i>BUK653R4-40C</i> ^[1]	<i>BUK6E3R4-40C</i>			
3.6		100	0.74			<i>BUK763R6-40C</i>		
4		100	0.74	<i>BUK754R0-40C</i>				
4	4.4	75	0.5	BUK9504-40A	BUK9E04-40A	BUK9604-40A		
4	4.4	75	0.59	BUK954R4-40B	BUK9E4R4-40B	BUK964R4-40B		
4		75	0.74			<i>BUK764R0-40C</i>		
4.3		75	0.59	BUK754R3-40B		BUK764R3-40B		
4.5		75	0.5	BUK7504-40A	BUK7E04-40A	BUK7604-40A		
4.6			0.95			<i>BUK664R6-40C</i>		
4.8			0.95	<i>BUK654R8-40C</i> ^[1]				
5			0.95				<i>BUK625R0-40C</i>	
5	6.4	75	0.74	BUK9506-40B		BUK9606-40B		
5		75	0.95				<i>BUK725R0-40C</i>	
5.2		75	0.74	BUK755R2-40B		BUK765R2-40B		
6.2	9	37	1.42					<i>BUK9Y09-40B</i>
7	9	75	0.95	BUK9509-40B		BUK9609-40B	BUK9209-40B	
7		75	0.95				<i>BUK7207-40B</i>	
8		75	0.95	BUK7508-40B		BUK7608-40B		
8		75	1.42					<i>BUK7Y08-40B</i>
8		75	0.95				BUK7208-40B	
11	14	56	1.8					BUK9Y14-40B
13		58	1.8					BUK7Y13-40B
18.7	27	34	2.53					<i>BUK9Y27-40B</i>
25		35	2.53					<i>BUK7Y25-40B</i>

Types in **bold red** represent new products

Types in **bold red italic underline** represent products in development





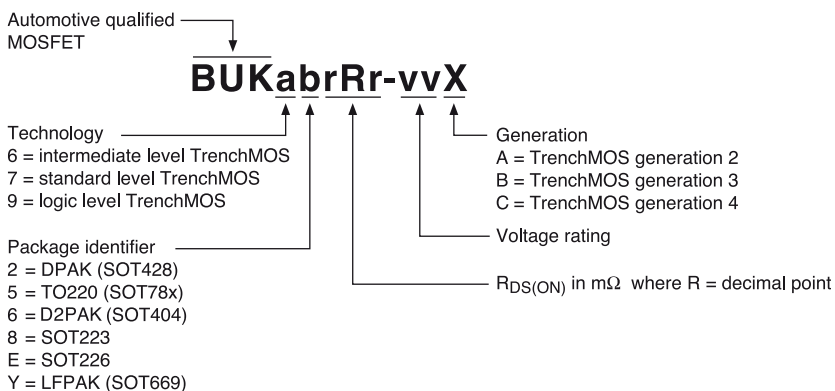

^[1] these products use SOT78B package

Automotive TrenchMOS part numbering



Selection Guides

55 V N-channel Automotive TrenchMOS







R _{DSon} (max) @10 V (mΩ)	R _{DSon} (max) @5 V (mΩ)	I _D (max) @25 °C (A)	R _{th(j-mb)} (max) (K/W)	3-lead TO-220AB (SOT78A)	I2PAK (SOT226)	D2PAK (SOT404)	DPAK (SOT428)	LPAK (SOT669)	SC-73 (SOT223)
									
				15.5 × 10.0 × 4.3	11.0 × 10.0 × 4.3	11.0 × 10.0 × 4.3	6.0 × 6.6 × 2.3	3.95 × 4.9 × 1.1	6.5 × 3.5 × 1.65
2.6		100	0.45			<i>BUK762R6-55C</i>			
2.7			0.45			<i>BUK662R7-55C</i>			
3			0.59			<i>BUK663R0-55C</i>			
3.2			0.45	<i>BUK653R2-55C⁽¹⁾</i>	<i>BUK6E3R2-55C</i>				
3.2		100	0.45	<i>BUK753R2-55C</i>					
3.5			0.59	<i>BUK653R5-55C⁽¹⁾</i>					
3.7	4.2	75	0.5	BUK954R2-55B		BUK964R2-55B			
4		75	0.5			BUK764R0-55B			
4		75	0.5	BUK754R0-55B					
4.6			0.74	<i>BUK654R6-55C⁽¹⁾</i>		<i>BUK664R4-55C</i>			
5.4	6	75	0.58	BUK9506-55B	BUK9E06-55B	BUK9606-55B			
5.8	6.3	75	0.58		BUK9E06-55A	BUK9606-55A			
6		75	0.59	BUK7506-55B		BUK7606-55B			
6.3		75	0.5	BUK7506-55A		BUK7606-55A			
7			0.95	<i>BUK6507-55C⁽¹⁾</i>		<i>BUK6607-55C</i>	<i>BUK6207-55C</i>		
7	8.4	75	0.74	BUK9508-55B	BUK9E08-55B	BUK9608-55B			
7.1		75	0.74	BUK7507-55B	BUK7E07-55B	BUK7607-55B			
7.5	8	75	0.59			BUK9608-55A			
8	9	75	0.71			BUK9609-55A			
8		75	0.59	BUK7508-55A		BUK7608-55A			
9	10	75	0.75	BUK9510-55A		BUK9610-55A			
9		75	0.71	BUK7509-55A		BUK7609-55A			
9.2	12	65	1.42					<i>BUK9Y12-55B</i>	
10	11	75	0.9	BUK9511-55A		BUK9611-55A			
10	12	75	0.95	BUK9512-55B		BUK9612-55B	BUK9212-55B		
10		75	0.5	BUK7510-55AL		BUK7610-55AL	BUK7210-55B		
11		75	0.95	BUK7511-55B	BUK7E11-55B	BUK7611-55B			
12		75	0.95				BUK7212-55B		
12		64	1.42					<i>BUK7Y12-55B</i>	
13	14	73	1	BUK9514-55A		BUK9614-55A			
13.6	15	62	1.3				BUK9215-55A		
14		73	0.9	BUK7514-55A		BUK7614-55A			
15	16	66	1.1	BUK9516-55A					
15		62	1.3				BUK7215-55A		
16		65	1.1	BUK7516-55A					

Types in **bold red** represent new products

Types in **bold red italic underline** represent products in development

⁽¹⁾ these products use SOT78B package

55 V N-channel Automotive TrenchMOS

R _{DSon} (max) @10 V (mΩ)	R _{DSon} (max) @5 V (mΩ)	I _D (max) @25 °C (A)	R _{th(j-mb)} (max) (K/W)	3-lead TO-220AB (SOT78A)	I2PAK (SOT226)	D2PAK (SOT404)	DPAK (SOT428)	LPAK (SOT669)	SC-73 (SOT223)
									
				15.5 x 10.0 x 4.3	11.0 x 10.0 x 4.3	11.0 x 10.0 x 4.3	6.0 x 6.6 x 2.3	3.95 x 4.9 x 1.1	6.5 x 3.5 x 1.65
16	18	61	1.1	BUK9518-55A		BUK9618-55A			
17.3	19	46	1.8					BUK9Y19-55B	
17.6	19	55	1.3				BUK9219-55A		
18	20	54	1.2	BUK9520-55A		BUK9620-55A			
18		47	1.76					<u>BUK7Y18-55B</u>	
19		55	1.3				BUK7219-55A		
20		54	1.2	BUK7520-55A		BUK7620-55A			
20	22	48	1.5				BUK9222-55A		
21.7	24	46	1.4	BUK9524-55A		BUK9624-55A			
22		48	1.5				BUK7222-55A		
22	25	43	1.6				BUK9225-55A		
25		43	1.6				BUK7225-55A		
25	28	42	1.56			BUK9628-55A			
27	30	38	1.7				BUK9230-55A		
28		42	1.5	BUK7528-55A		BUK7628-55A			
29	32	12	15						BUK9832-55A
30		38	1.7				BUK7230-55A		
32	35	34	1.8	BUK9535-55A		BUK9635-55A			
33	37	32	1.94				BUK9237-55A		
35		35	1.75	BUK7535-55A		BUK7635-55A			
35		28	2.53					<u>BUK7Y35-55B</u>	
36	40	26	2.5					BUK9Y40-55B	
37		32	1.9				BUK7237-55A		
40	45	28	2.1				BUK9245-55A		
68	75	20	2.4	BUK9575-55A		BUK9675-55A			
69	77	18	3				BUK9277-55A		
73	80	7	15						BUK9880-55A
75		20	2.4	BUK7575-55A		BUK7675-55A			
77		18	2.9				BUK7277-55A		
80		7	15						BUK7880-55A
125	140	11	4.1				BUK92150-55A		
137	150	13	2.8	BUK95150-55A					
137	150	5.5	15						BUK98150-55A
150		11	4.1	BUK75150-55A			BUK72150-55A		
150		5.5	15						BUK78150-55A





Types in **bold red** represent new products

Types in **bold red italic underline** represent products in development

⁽¹⁾ these products use SOT78B package

Selection Guides

75 V N-channel Automotive TrenchMOS







R _{DSon} (max) @10 V (mΩ)	R _{DSon} (max) @5 V (mΩ)	I _D (max) @25 °C (A)	R _{th(j-mb)} (max) (K/W)	3-lead TO-220AB (SOT78A)	I2PAK (SOT226)	D2PAK (SOT404)	DDPAK (SOT428)	LPPAK (SOT669)
								
				15.5 x 10.0 x 4.3	11.0 x 10.0 x 4.3	11.0 x 10.0 x 4.3	6.0 x 6.6 x 2.3	3.95 x 4.9 x 1.1
3.7			0.45			<u>BUK663R7-75C</u>		
4			0.45	<u>BUK654R0-75C</u> ^[1]	<u>BUK6E4R0-75C</u>			
4		100	0.45			BUK764R0-75C		
4.3		100	0.45	BUK754R3-75C	BUK7E4R3-75C			
4.8			0.59			<u>BUK664R8-75C</u>		
5			0.59	<u>BUK655R0-75C</u> ^[1]				
5.5	6.1	75	0.5	BUK9506-75B		BUK9606-75B		
5.6		75	0.5	BUK7506-75B		BUK7606-75B		
7		100	0.74	<u>BUK6507-75C</u> ^[1]		<u>BUK6607-75C</u>		
8.5	9	75	0.65	<u>BUK9509-75A</u>		BUK9609-75A		
9		75	0.65	BUK7509-75A		BUK7609-75A		
10		71	0.95	<u>BUK6510-75C</u> ^[1]		<u>BUK6610-75C</u>		
11			0.95				<u>BUK6211-75C</u>	
11		75	0.95				<u>BUK7211-75C</u>	
13		75	0.95	BUK7513-75B		BUK7613-75B		
14		70	0.95				BUK7214-75B	
14	16.4	67	0.95	BUK9516-75B		BUK9616-75B		
15	17	64	0.95				BUK9217-75B	
16.2	19	48	1.42					<u>BUK9Y19-75B</u>
18		49	1.42					<u>BUK7Y18-75B</u>
22	23	53	1.1	BUK9523-75A		BUK9623-75A		
23		53	1.1	BUK7523-75A		BUK7623-75A		
24.6	26	45	1.3				BUK9226-75A	
26		45	1				BUK7226-75A	
28		35	1.76					<u>BUK7Y28-75B</u>
28	30	34	1.8					BUK9Y30-75B
49.8	58	20	2.53					<u>BUK9Y58-75B</u>
54		21	2.53					<u>BUK7Y54-75B</u>

Types in **bold red** represent new products

Types in **bold red italic underline** represent products in development

^[1] These products are in SOT78B package

100 V N-channel Automotive TrenchMOS

R_{DSon} (max) @10 V (m Ω)	R_{DSon} (max) @5 V (m Ω)	I_D (max) @25 °C (A)	$R_{th(j-mb)}$ (max) (K/W)	3-lead TO-220AB (SOT78A)	I2PAK (SOT226)	D2PAK (SOT404)	DPAK (SOT428)	LFPAK (SOT669)	SC-73 (SOT223)
									
				15.5 x 10.0 x 4.3	11.0 x 10.0 x 4.3	11.0 x 10.0 x 4.3	6.0 x 6.6 x 2.3	3.95 x 4.9 x 1.1	6.5 x 3.5 x 1.65
9.7	10	75	0.5	BUK9510-100B		BUK9610-100B			
10		75	0.5	BUK7510-100B		BUK7610-100B			
14.4	15	75	0.65	BUK9515-100A		BUK9615-100A			
15		75	0.65	BUK7515-100A					
18.5	20	63	0.75	BUK9520-100B		BUK9620-100B			
19		64	0.75			BUK7619-100B			
19	20	63	0.75	BUK9520-100A					
20		63	0.75	BUK7520-100A		BUK7620-100A			
26		49	0.95	BUK7526-100B		BUK7626-100B			
27	28	49	0.9			BUK9628-100A			
27		48	0.95				BUK7227-100B		
27	29	46	0.95	BUK9529-100B		BUK9629-100B			
28	30	47	0.95				BUK9230-100B		
28		47	0.9	BUK7528-100A		BUK7628-100A			
31.2	34	35	1.42					<u>BUK9Y34-100B</u>	
33		35	1.42					<u>BUK7Y33-100B</u>	
34	35	41	1	BUK9535-100A		BUK9635-100A			
35		41	1	BUK7535-100A		BUK7635-100A			
38.6	40	33	1.3				BUK9240-100A		
39	40	39	0.95			BUK9640-100A			
40		37	1.1	BUK7540-100A		BUK7640-100A			
40		34	1.3				BUK7240-100A		
49	53	23	2					BUK9Y53-100B	
53		24	1.76					<u>BUK7Y53-100B</u>	
58	60	26	1.4			BUK9660-100A			
60		26	1.4			BUK7660-100A			
72	75	23	1.5	BUK9575-100A		BUK9675-100A			
72	75	21	1.7				BUK9275-100A		
72	75	7	15						BUK9875-100A
75		23	1.5	BUK7575-100A		BUK7675-100A			
75		21	1.7				BUK7275-100A		
95.7	104	14	2.53					<u>BUK9Y104-100B</u>	
102		15	2.53					<u>BUK7Y102-100B</u>	
173	180	11	2.8	BUK95180-100A		BUK96180-100A			
173	180	4.6	15						BUK98180-100A

Types in **bold red** represent new products





Types in **bold red italic underline** represent products in development

Selection Guides

TrenchPLUS MOSFETs

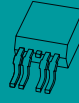
TrenchPLUS is a range of standard MOSFETs with additional protection features, such as current and temperature sensing components, overvoltage clamps, and gate protection (ESD) diodes. The system microcontroller can use data gathered from



these sensors to implement cost-effective protection features, thus eliminating the need to design with protected power devices. All the standard products listed below offer one or more "PLUS" features. Custom versions can be developed for high-volume applications.

V_{DS} (V)	R_{DSon} (max) @10 V (m Ω)	R_{DSon} (max) @5 V (m Ω)	I_b (max) @25 °C (A)	Temp Sense	Gate Source Clamps	Gate Drain Clamps	Current Sensing	Gate Resistor	Surface Mount Package			Leaded Package	
									7-pin D2PAK (SOT427)	5-pin D2PAK (SOT426)	SO20 (SOT163)	TO220AB (SOT78C)	5-pin TO220 (SOT263B-01)
													
									11.0 x 10.0 x 4.3	11.0 x 10.0 x 4.3	13.0 x 7.5 x 2.65	15.0 x 10.0 x 4.5	15.0 x 10.0 x 4.5
34	3.3		75		✓	✓		✓				BUK7L3R3-34BRC	
34	6		75		✓	✓		✓				BUK7L06-34ARC	
34	11		75		✓	✓		✓				BUK7L11-34ARC	
40	4.1		75	✓									BUK794R1-40BT
40	5		75		✓		✓						BUK7905-40AIE
40	5		75	✓	✓								BUK7905-40ATE
40	5		75				✓						BUK7905-40AI
40	6		75	✓	✓		✓		BUK7C06-40AITE				
40	6.6	7	75	✓	✓	✓							BUK9907-40ATC
40	7		75	✓	✓	✓							BUK7907-40ATC
40	8		75		✓		✓						BUK7908-40AIE
55	6.6	7	75	✓	✓								BUK9907-55ATE
55	7		75		✓		✓						BUK7907-55AIE
55	7		75	✓	✓								BUK7907-55ATE
55	8		75	✓	✓		✓		BUK7C08-55AITE				
55	9	10	75	✓			✓		BUK9C10-55BIT				

Types in **bold red** represent new products

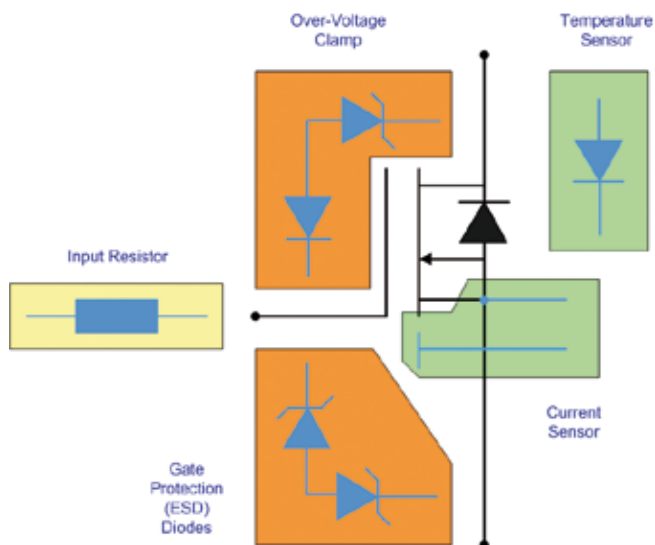
Types in ***bold red underline*** represent products in development



V _{DS} (V)	R _{DS(on)} (max) @10 V (mΩ)	R _{DS(on)} (max) @5 V (mΩ)	I _S (max) @25 °C (A)	Temp Sense	Gate Source Clamps	Gate Drain Clamps	Current Sensing	Gate Resistor	Surface Mount Package			Leaded Package	
									7-pin D2PAK (SOT427)	5-pin D2PAK (SOT426)	SO20 (SOT163)	TO220AB (SOT78C)	5-pin TO220 (SOT263B-01)
													
								11.0 x 10.0 x 4.3	11.0 x 10.0 x 4.3	13.0 x 7.5 x 2.65	15.0 x 10.0 x 4.5	15.0 x 10.0 x 4.5	
55	9+23	10+25	17+9	✓			✓				BUK9MGP-55PTS		
55	14+14	15+15	13+13	✓			✓				BUK9MJJ-55PSS		
55	14+14	15+15	13+13	✓			✓				BUK9MJJ-55PTT		
55	14+90	15+100	13+4	✓			✓				BUK9MJT-55PRF		
55	23+23	25 + 25	9+9	✓			✓				BUK9MPP-55PRR		
55	27+27	30+30	8+8	✓			✓				BUK9MMM-55PNN		
55	45+45	50+50	6+6	✓			✓				BUK9MLL-55PLL		
55	56+56	65+65	5+5	✓			✓				BUK9MRR-55PGG		
65	6,5	7	75	✓			✓		<u>BUK9C07-65BIT</u>				
65	9,2	10	75	✓			✓		<u>BUK9C10-65BIT</u>				
65	11+11	12+12	15+15	✓			✓				BUK9MHH-65PNN		
65	13+13	14+14	13+13	✓			✓				BUK9MFF-65PSS		
65	16+16	17+17	11+11	✓			✓				BUK9MJJ-65PLL		
65	25+25	27+27	8+8	✓			✓				BUK9MPP-65PLL		
65	33+33	36+36	7+7	✓			✓				BUK9MNN-65PKK		
65	61+61	67+67	5+5	✓			✓				BUK9MRR-65PKK		
65	90+90	100+100	4+4	✓			✓				BUK9MTT-65PBB		
75	7		75	✓	✓					BUK7109-75ATE			BUK7909-75ATE
75	9		75		✓		✓			BUK7109-75AIE			BUK7909-75AIE
75	10		75	✓	✓		✓		BUK7C10-75AITE				

Types in **bold red** represent new products
Types in **bold red italic underline** represent products in development

Automotive TrenchPLUS part numbering

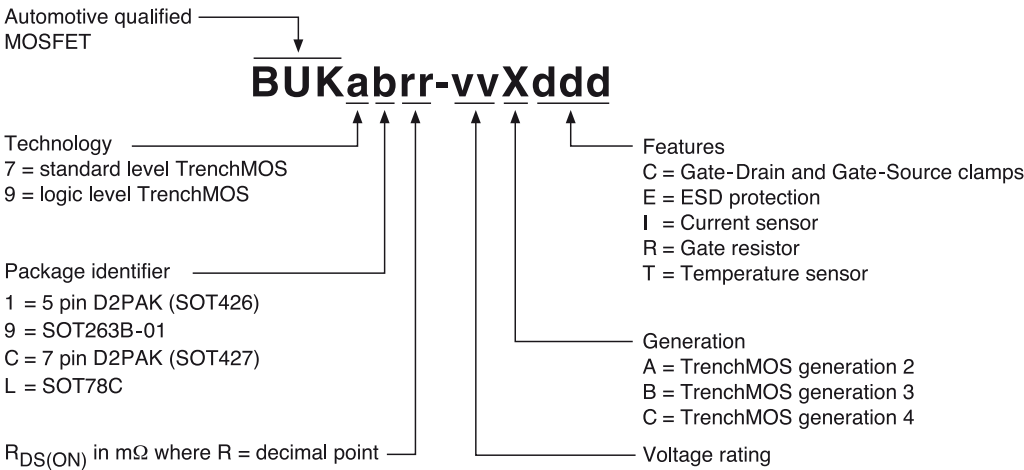

Application Guidelines

Key application requirements

- 1 Mechanical robustness
For high-vibration environments
- 2 Avalanche rugged
Tolerating V_{DS} overvoltage stress
- 3 Thermal robustness
Using maximum die temperature of 175 °C
- 4 Low ON resistance
Using MOSFETs with low $R_{DS(ON)}$
- 5 Linear-mode capable
Operating in linear mode under certain conditions
- 6 Compact power package
For small footprint and minimum PCB area
- 7 High surge-current rating
Capable of transient current overload

Typical ABS/ESP system

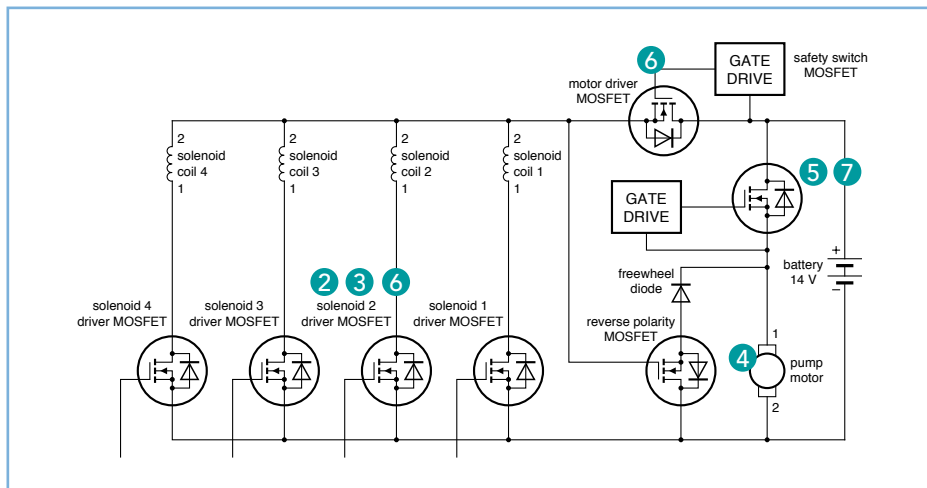

Motor drive for electric parking brake

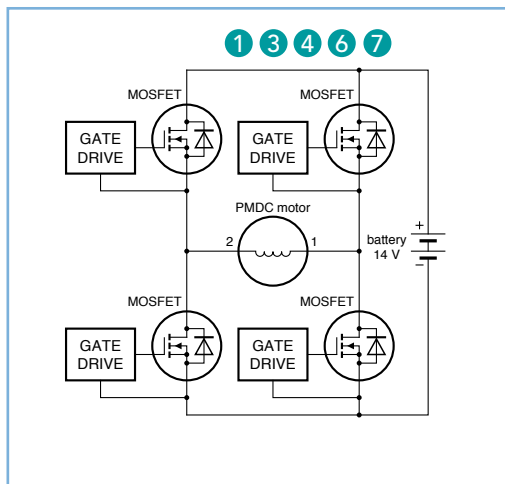

Integrated starter generator (ISG) for micro/mild hybrids

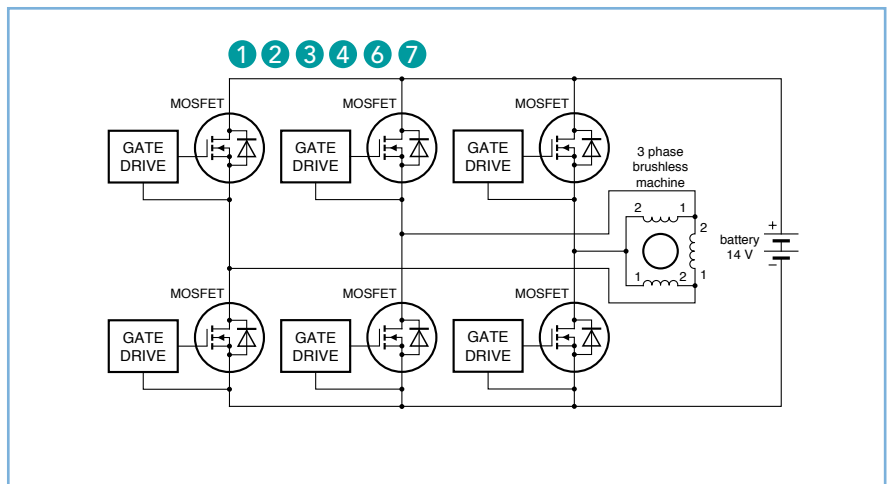

Application Guidelines

Drives for brushless 3 phase motors showing a MOSFET for reverse polarity protection

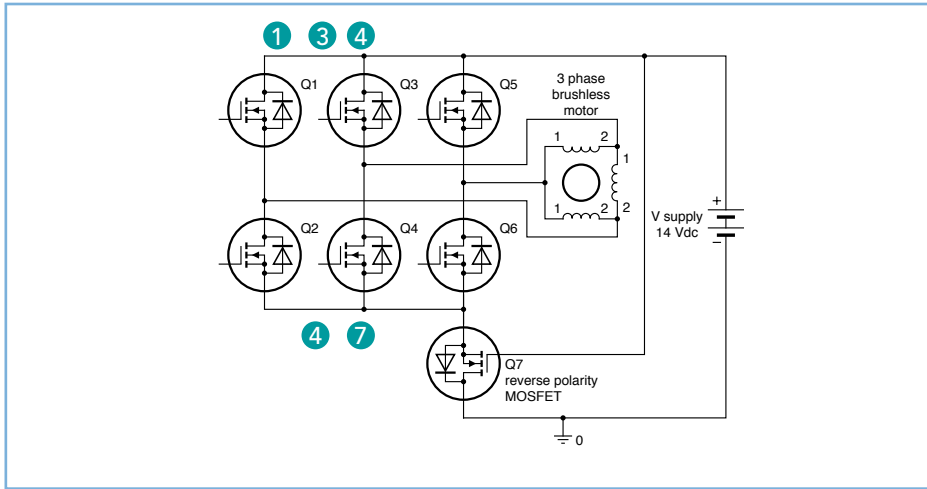

HS drive for brushed D.C. motor

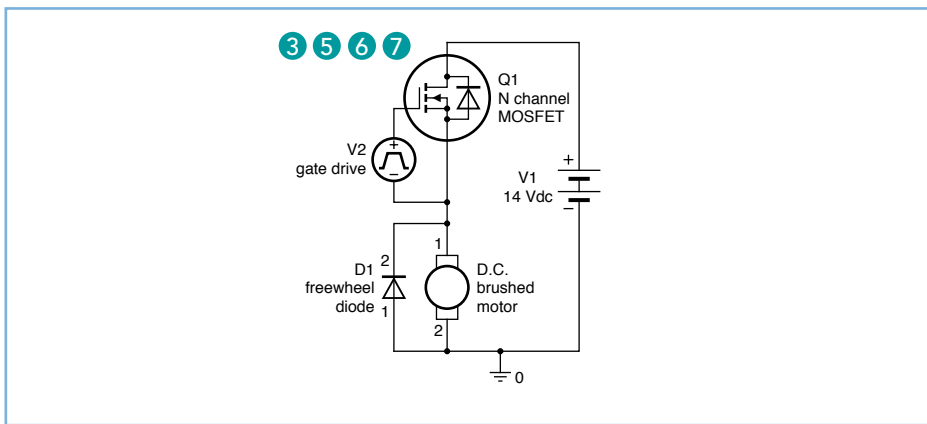

Typical diesel fuel injector drive

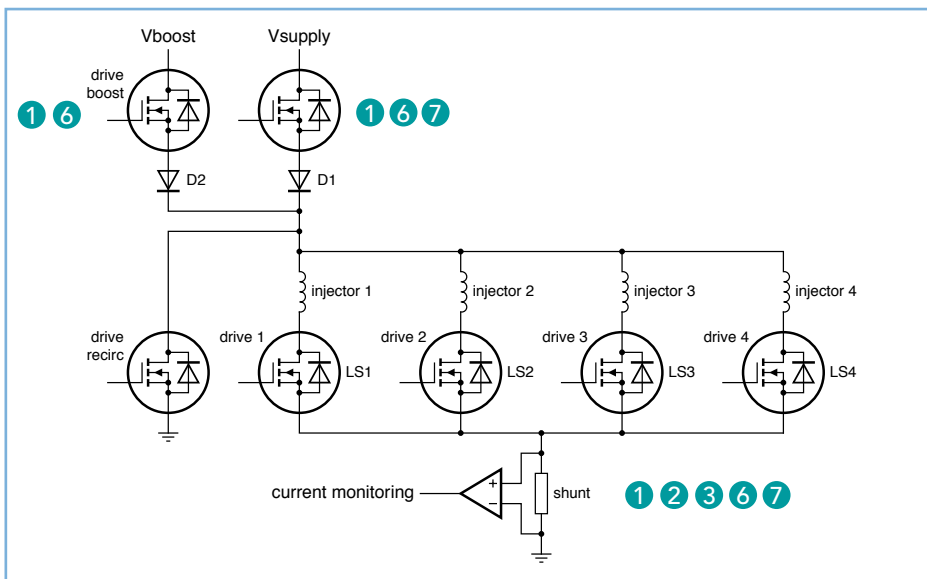



www.nxp.com

© 2009 NXP B.V.

All rights reserved. Reproduction in whole or in part is prohibited without the prior written consent of the copyright owner. The information presented in this document does not form part of any quotation or contract, is believed to be accurate and reliable and may be changed without notice. No liability will be accepted by the publisher for any consequence of its use. Publication thereof does not convey nor imply any license under patent- or other industrial or intellectual property rights.

Date of release: August 2009

Document order number: 9397 750 16723

Printed in the Netherlands

founded by

PHILIPS