

Unimate Range - SLA/BLA

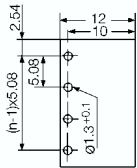

Pin headers SLA 5.08/90

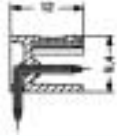
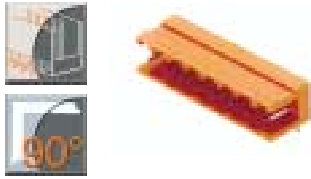

Technical data	VDE	UL	CSA
Rated voltage (V)	250*	300	300
Rated current (A)	10	10	10

*Pollution severity 3 / Overvoltage category III
Additional technical data see page 227

Solder pin length 4.5 mm

Color



Poles	Type	Part No.	Qty.
2	SLA 5.08/2/90	1346860000	100
3	SLA 5.08/3/90	1346960000	100
4	SLA 5.08/4/90	1347060000	100
5	SLA 5.08/5/90	1347160000	50
6	SLA 5.08/6/90	1347260000	50
7	SLA 5.08/7/90	1347360000	50
8	SLA 5.08/8/90	1347460000	50
9	SLA 5.08/9/90	1347560000	50
10	SLA 5.08/10/90	1347660000	50
11	SLA 5.08/11/90	1347760000	50
12	SLA 5.08/12/90	1347860000	50
13	SLA 5.08/13/90	1347960000	50
14	SLA 5.08/14/90	1348060000	50
15	SLA 5.08/15/90	1348160000	50
16	SLA 5.08/16/90	1348260000	50
17	SLA 5.08/17/90	1348360000	20
18	SLA 5.08/18/90	1348460000	20
19	SLA 5.08/19/90	1348560000	20
20	SLA 5.08/20/90	1348660000	20
21	SLA 5.08/21/90	1348760000	20
22	SLA 5.08/22/90	1348860000	20
23	SLA 5.08/23/90	1348960000	20
24	SLA 5.08/24/90	1349060000	20

Accessories	Page
Mounting	-
Marking	190
Coding	193
Miscellaneous	199

Pin headers SLA 5.08/90B

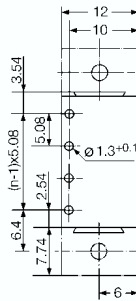
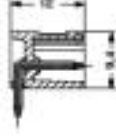
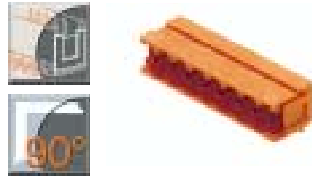

Technical data	VDE	UL	CSA
Rated voltage (V)	250*	300	300
Rated current (A)	10	10	10

*Pollution severity 3 / Overvoltage category III
Additional technical data see page 227

Solder pin length 4.5 mm

Color



Poles	Type	Part No.	Qty.
2	SLA 5.08/2/90B	1351460000	100
3	SLA 5.08/3/90B	1351560000	100
4	SLA 5.08/4/90B	1351660000	100
5	SLA 5.08/5/90B	1351760000	50
6	SLA 5.08/6/90B	1351860000	50
7	SLA 5.08/7/90B	1351960000	50
8	SLA 5.08/8/90B	1352060000	50
9	SLA 5.08/9/90B	1352160000	50
10	SLA 5.08/10/90B	1352260000	50
11	SLA 5.08/11/90B	1352360000	50
12	SLA 5.08/12/90B	1352460000	50
13	SLA 5.08/13/90B	1352560000	50
14	SLA 5.08/14/90B	1352660000	50
15	SLA 5.08/15/90B	1352760000	50
16	SLA 5.08/16/90B	1352860000	50
17	SLA 5.08/17/90B	1352960000	20
18	SLA 5.08/18/90B	1353060000	20
19	SLA 5.08/19/90B	1353160000	20
20	SLA 5.08/20/90B	1353260000	20
21	SLA 5.08/21/90B	1353360000	20
22	SLA 5.08/22/90B	1353460000	20
23	SLA 5.08/23/90B	1353560000	20
24	SLA 5.08/24/90B	1353660000	20

Accessories	Page
Mounting	187*
Marking	190
Coding	193
Miscellaneous	199

Pin headers SLA 5.08/180

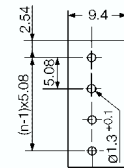
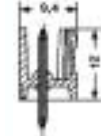
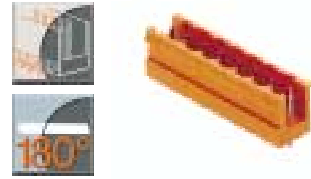

Technical data	VDE	UL	CSA
Rated voltage (V)	250*	300	300
Rated current (A)	10	10	10

*Pollution severity 3 / Overvoltage category III
Additional technical data see page 227

Solder pin length 4.5 mm

Color



Poles	Type	Part No.	Qty.
2	SLA 5.08/2/180	1349160000	100
3	SLA 5.08/3/180	1349260000	100
4	SLA 5.08/4/180	1349360000	100
5	SLA 5.08/5/180	1349460000	50
6	SLA 5.08/6/180	1349560000	50
7	SLA 5.08/7/180	1349660000	50
8	SLA 5.08/8/180	1349760000	50
9	SLA 5.08/9/180	1349860000	50
10	SLA 5.08/10/180	1349960000	50
11	SLA 5.08/11/180	1350060000	50
12	SLA 5.08/12/180	1350160000	50
13	SLA 5.08/13/180	1350260000	50
14	SLA 5.08/14/180	1350360000	50
15	SLA 5.08/15/180	1350460000	50
16	SLA 5.08/16/180	1350560000	50
17	SLA 5.08/17/180	1350660000	20
18	SLA 5.08/18/180	1350760000	20
19	SLA 5.08/19/180	1350860000	20
20	SLA 5.08/20/180	1350960000	20
21	SLA 5.08/21/180	1351060000	20
22	SLA 5.08/22/180	1351160000	20
23	SLA 5.08/23/180	1351260000	20
24	SLA 5.08/24/180	1351360000	20

Accessories	Page
Mounting	-
Marking	190
Coding	193
Miscellaneous	-

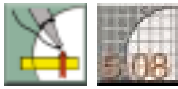

Pin headers SLA 5.08/180B

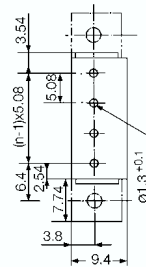
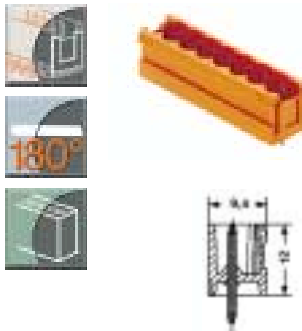

Technical data	VDE	UL	CSA
Rated voltage (V)	250*	300	300
Rated current (A)	10	10	10

*Pollution severity 3 / Overvoltage category III
Additional technical data see page 226

Solder pin length 4.5 mm

Color

Poles	Type	Part No.	Qty.
2	SLA 5.08/2/180B	1353760000	100
3	SLA 5.08/3/180B	1353860000	100
4	SLA 5.08/4/180B	1353960000	100
5	SLA 5.08/5/180B	1354060000	50
6	SLA 5.08/6/180B	1354160000	50
7	SLA 5.08/7/180B	1354260000	50
8	SLA 5.08/8/180B	1354360000	50
9	SLA 5.08/9/180B	1354460000	50
10	SLA 5.08/10/180B	1354560000	50
11	SLA 5.08/11/180B	1354660000	50
12	SLA 5.08/12/180B	1354760000	50
13	SLA 5.08/13/180B	1354860000	50
14	SLA 5.08/14/180B	1354960000	50
15	SLA 5.08/15/180B	1355060000	50
16	SLA 5.08/16/180B	1355160000	50
17	SLA 5.08/17/180B	1355260000	20
18	SLA 5.08/18/180B	1355360000	20
19	SLA 5.08/19/180B	1355460000	20
20	SLA 5.08/20/180B	1355560000	20
21	SLA 5.08/21/180B	1355660000	20
22	SLA 5.08/22/180B	1355760000	20
23	SLA 5.08/23/180B	1355860000	20
24	SLA 5.08/24/180B	1355960000	20

Accessories	Page
Mounting	187*
Marking	190
Coding	193
Miscellaneous	-

Pin headers SLAKU 5.08

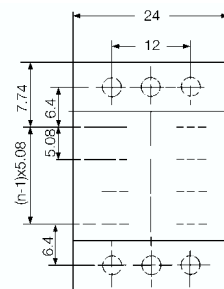
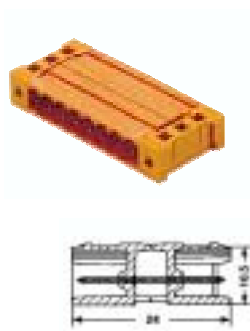

Technical data	VDE	UL	CSA
Rated voltage (V)	250*	300	300
Rated current (A)	10	10	8

*Pollution severity 3 / Overvoltage category III

Solder pin length 4.5 mm

Color

Poles	Type	Part No.	Qty.
2	SLAKU 5.08/2	1359660000	50
3	SLAKU 5.08/3	1359760000	50
4	SLAKU 5.08/4	1342760000	50
5	SLAKU 5.08/5	1359860000	25
6	SLAKU 5.08/6	1359960000	25
7	SLAKU 5.08/7	1360060000	20
8	SLAKU 5.08/8	1342860000	20
9	SLAKU 5.08/9	1360160000	20
10	SLAKU 5.08/10	1360260000	20
11	SLAKU 5.08/11	1360360000	10
12	SLAKU 5.08/12	1360460000	10

Accessories	Page
Mounting	-
Marking	-
Coding	-
Miscellaneous	-

Pin headers SLAD 5.08/90

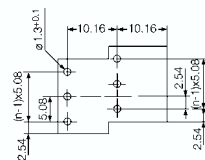
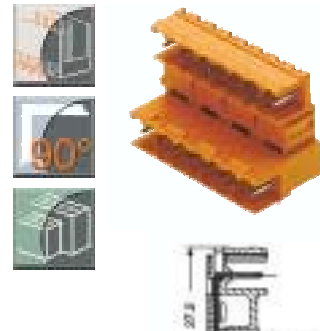

Technical data	VDE	UL	CSA
Rated voltage (V)	250*	300	300
Rated current (A)	8	10	7

*Pollution severity 3 / Overvoltage category III
Additional technical data see page 227

Solder pin length 4.5 mm

Color

Poles	Type	Part No.	Qty.
4	SLAD 5.08/4/90	1321660000	50
6	SLAD 5.08/6/90	1321760000	50
8	SLAD 5.08/8/90	1385560000	50
10	SLAD 5.08/10/90	1385660000	50
12	SLAD 5.08/12/90	1385760000	50
14	SLAD 5.08/14/90	1385860000	50
16	SLAD 5.08/16/90	1385960000	20
18	SLAD 5.08/18/90	1386060000	20
20	SLAD 5.08/20/90	1386160000	20
22	SLAD 5.08/22/90	1386260000	10
24	SLAD 5.08/24/90	1386360000	10
26	SLAD 5.08/26/90	1386460000	10
28	SLAD 5.08/28/90	1386560000	10
30	SLAD 5.08/30/90	1386660000	10
32	SLAD 5.08/32/90	1386760000	10
34	SLAD 5.08/34/90	1386860000	10
36	SLAD 5.08/36/90	1386960000	10
38	SLAD 5.08/38/90	1387060000	10
40	SLAD 5.08/40/90	1387160000	10
42	SLAD 5.08/42/90	1387260000	10
44	SLAD 5.08/44/90	1387360000	10
46	SLAD 5.08/46/90	1387460000	10
48	SLAD 5.08/48/90	1387570000	10

Accessories	Page
Mounting	188
Marking	190
Coding	192, 193
Miscellaneous	-

* See Note, page 187