

# Low-Cost Stereo Audio DAC

## General Description

The MAX5556 stereo audio sigma-delta digital-to-analog converter (DAC) offers a simple and complete stereo digital-to-analog solution for media servers, set-top boxes, video-game hardware, automotive rear-seat entertainment, and other general consumer audio applications. This DAC features built-in digital interpolation/filtering, sigma-delta digital-to-analog conversion, and analog output filtering. Control logic and mute circuitry minimize audible pops and clicks during power-up, power-down, clock changes, or when invalid clock conditions occur.

The MAX5556 receives input data over a 3-wire I<sup>2</sup>S-compatible interface with left-justified audio data. Data can be clocked by either an external or internal serial clock. The internal serial clock frequency is programmable by selection of a master clock (MCLK) and sample clock (LRCLK) ratio. Sampling rates from 2kHz to 50kHz are supported.

The MAX5556 operates from a single +4.75V to +5.5V analog supply with total harmonic distortion plus noise below -87dB. This device is available in an 8-pin SO package and is specified over the -40°C to +85°C industrial temperature range.

## Applications

Digital Video Recorders and Media Servers  
Set-Top Boxes  
Video-Game Hardware  
Automotive Rear-Seat Entertainment

## Typical Operating Circuit

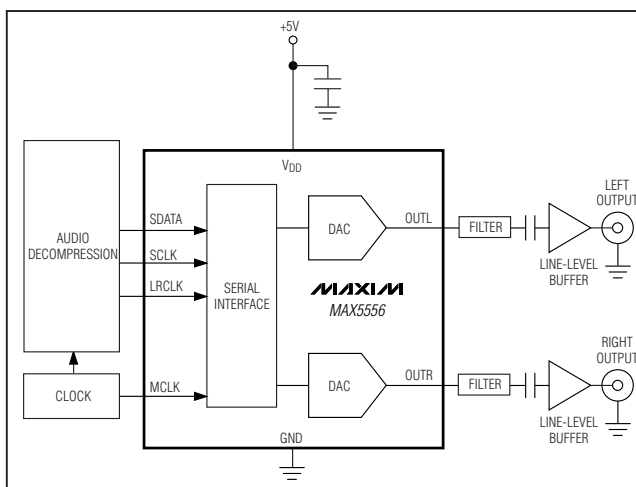

## Features

- ◆ Simple and Complete Stereo Audio DAC Solutions, No Controls to Set
- ◆ Sigma-Delta Stereo DACs with Built-In Interpolation and Analog Output Filters
- ◆ I<sup>2</sup>S-Compatible Digital Audio Interface
- ◆ Clickless/Popless Operation
- ◆ 3.5V<sub>p-p</sub> Output Voltage Swing
- ◆ -87dB THD+N
- ◆ +87dB Dynamic Range
- ◆ Sample Frequencies (fs) from 2kHz to 50kHz
- ◆ Master Clock (MCLK) up to 25MHz
- ◆ Automatic Detection of Clock Ratio (MCLK/LRCLK)

## Ordering Information

PART	TEMP RANGE	PIN-PACKAGE	DATA FORMAT
MAX5556ESA+	-40°C to +85°C	8 SO	Left-justified I <sup>2</sup> S data
MAX5556ESA/V+	-40°C to +85°C	8 SO	Left-justified I <sup>2</sup> S data

+Denotes a lead(Pb)-free/RoHS-compliant package. For leaded version, contact factory.

/V denotes an automotive-qualified part.

## Pin Configuration

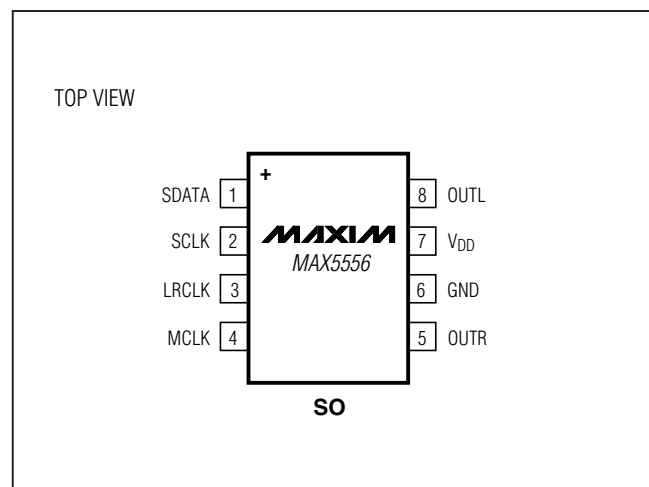

# Low-Cost Stereo Audio DAC

## ABSOLUTE MAXIMUM RATINGS

V<sub>DD</sub> to GND .....-0.3V to +6.0V  
 OUTL, OUTF, SDATA to GND ..... -0.3V to (V<sub>DD</sub> + 0.3V)  
 Current Any Pin (excluding V<sub>DD</sub> and GND).....±10mA  
 OUTL, OUTF Shorted to GND.....Continuous  
 SCLK, LRCLK, MCLK to GND .....-0.3V to +6.0V  
 Continuous Power Dissipation (T<sub>A</sub> = +70°C)  
 8-Pin SO (derate 5.88mW/°C above +70°C).....471mW

Package Thermal Resistance (θ<sub>JA</sub>) .....170°C/W  
 Operating Temperature Range .....-40°C to +85°C  
 Junction Temperature .....+150°C  
 Storage Temperature Range .....-65°C to +150°C  
 Lead Temperature (soldering, 10s) .....+300°C  
 Soldering Temperature (reflow) .....+260°C

Stresses beyond those listed under "Absolute Maximum Ratings" may cause permanent damage to the device. These are stress ratings only, and functional operation of the device at these or any other conditions beyond those indicated in the operational sections of the specifications is not implied. Exposure to absolute maximum rating conditions for extended periods may affect device reliability.

## ELECTRICAL CHARACTERISTICS

(V<sub>DD</sub> = +4.75V to +5.5V, V<sub>GND</sub> = 0V, R<sub>OUT\_</sub> = 10kΩ, C<sub>OUT\_</sub> = 10pF, 0dBFS sine-wave signal at 997Hz, f<sub>LRCLK</sub> (f<sub>S</sub>) = 48kHz, f<sub>MCLK</sub> = 12.288MHz, measurement bandwidth 10Hz to 20kHz, T<sub>A</sub> = -40°C to +85°C, outputs are unloaded, unless otherwise noted. Typical values at V<sub>DD</sub> = +5V, T<sub>A</sub> = +25°C.) (Note 1)

PARAMETER	SYMBOL	CONDITIONS	MIN	TYP	MAX	UNITS
<b>POWER SUPPLY</b>						
Supply Voltage	V <sub>DD</sub>		4.75	5.0	5.50	V
Supply Current	I <sub>DD</sub>	Up to 48ksps		13	15	mA
		Static digital		6	8.5	
Power Dissipation		Up to 48ksps		65	82.5	mW
		Static digital		30	44	
<b>DYNAMIC PERFORMANCE (Note 2)</b>						
Dynamic Range, 16-Bit		Unweighted	84	86		dB
		A-weighted	86	90		
Dynamic Range, 18-Bit to 24-Bit		Unweighted		87		dB
		A-weighted		91		
Total Harmonic Distortion Plus Noise, 16-Bit	THD+N	0dBFS		-86	-81	dB
		-20dBFS		-67		
		-60dBFS		-26	-24	
Total Harmonic Distortion Plus Noise, 18-Bit to 24-Bit	THD+N	0dBFS		-87		dB
		-20dBFS		-68		
		-60dBFS		-27		
Interchannel Isolation		1kHz full-scale output (crosstalk)		94		dB
<b>COMBINED DIGITAL AND INTEGRATED ANALOG FILTER FREQUENCY RESPONSE (Note 3)</b>						
Passband		-0.5dB corner	0.46			f <sub>S</sub>
		-3dB corner			0.49	
		-6dB corner			0.50	
Frequency Response/Passband Ripple		10Hz to 20kHz (f <sub>S</sub> = 48kHz)	-0.025		+0.08	dB
		10Hz to 20kHz (f <sub>S</sub> = 44.1kHz)	-0.025		+0.08	
		10Hz to 16kHz (f <sub>S</sub> = 32kHz)	-6.000		+0.073	
Stopband					0.5465	f <sub>S</sub>
Stopband Attenuation			52			dB
Group Delay	t <sub>gd</sub>			20/f <sub>S</sub>		s
Passband Group-Delay Variation	Δt <sub>gd</sub>	20Hz to 20kHz			±0.4/f <sub>S</sub>	s

# Low-Cost Stereo Audio DAC

MAX5556

## ELECTRICAL CHARACTERISTICS (continued)

( $V_{DD} = +4.75V$  to  $+5.5V$ ,  $V_{GND} = 0V$ ,  $R_{OUT\_} = 10k\Omega$ ,  $C_{OUT\_} = 10pF$ , 0dBFS sine-wave signal at 997Hz,  $f_{LRCLK} (f_s) = 48kHz$ ,  $f_{MCLK} = 12.288MHz$ , measurement bandwidth 10Hz to 20kHz,  $T_A = -40^\circ C$  to  $+85^\circ C$ , outputs are unloaded, unless otherwise noted. Typical values at  $V_{DD} = +5V$ ,  $T_A = +25^\circ C$ .) (Note 1)

PARAMETER	SYMBOL	CONDITIONS	MIN	TYP	MAX	UNITS
<b>DC CHARACTERISTICS</b>						
Interchannel Gain Mismatch				0.1	0.4	dB
Gain Error			-5		+5	%
Gain Drift				100		ppm/ $^\circ C$
<b>ANALOG OUTPUTS</b>						
Full-Scale Output Voltage	$V_{OUTR}, V_{OUTL}$		3.25	3.5	3.75	$V_{P-P}$
DC Quiescent Output Voltage	$V_Q$	Input code = 0		2.4		V
Minimum Load Resistance	$R_L$			3		$k\Omega$
Maximum Load Capacitance	$C_L$			100		pF
Power-Supply Rejection Ratio	PSRR	$V_{RIPPLE} = 100mV_{P-P}$ , frequency = 1kHz		66		dB
<b>POP AND CLICK SUPPRESSION</b>						
Mute Attenuation				100		dB
Power-Up Until Bias Established		Figure 11		360		ms
Valid Clock to Normal Operation		Soft-start ramp time, Figure 12 (Note 5)		20		ms
<b>DIGITAL AUDIO INTERFACE (SCLK, SDATA, MCLK, LRCLK)</b>						
Input-Voltage High	$V_{IH}$		2.0			V
Input-Voltage Low	$V_{IL}$				0.8	V
Input Leakage Current	$I_{IN}$		-10		+10	$\mu A$
Input Capacitance				8		pF
<b>TIMING CHARACTERISTICS</b>						
Input Sample Rate	$f_s$		2		50	kHz
MCLK Pulse-Width Low	$t_{MCLKL}$	MCLK/LRCLK = 512	10			ns
		MCLK/LRCLK = 384	20			
		MCLK/LRCLK = 256	20			
MCLK Pulse-Width High	$t_{MCLKH}$	MCLK/LRCLK = 512	10			ns
		MCLK/LRCLK = 384	20			
		MCLK/LRCLK = 256	20			
<b>EXTERNAL SCLK MODE</b>						
LRCLK Duty Cycle		(Note 6)	25		75	%
SCLK Pulse-Width Low	$t_{SCLKL}$		20			ns
SCLK Pulse-Width High	$t_{SCLKH}$		20			ns
SCLK Period	$t_{SCLK}$		$1/(128 \times f_s)$			ns
LRCLK Edge to SCLK Rising	$t_{SLRS}$		20			ns
LRCLK Edge to SCLK Rising	$t_{SLRH}$		20			ns
SDATA Valid to SCLK Rising	$t_{SDS}$		20			ns
SCLK Rising to SDATA Hold Time	$t_{SDH}$		20			ns

# Low-Cost Stereo Audio DAC

## ELECTRICAL CHARACTERISTICS (continued)

( $V_{DD} = +4.75V$  to  $+5.5V$ ,  $V_{GND} = 0V$ ,  $R_{OUT\_} = 10k\Omega$ ,  $C_{OUT\_} = 10pF$ , 0dBFS sine-wave signal at 997Hz,  $f_{LRCLK} (f_s) = 48kHz$ ,  $f_{MCLK} = 12.288MHz$ , measurement bandwidth 10Hz to 20kHz,  $T_A = -40^\circ C$  to  $+85^\circ C$ , outputs are unloaded, unless otherwise noted. Typical values at  $V_{DD} = +5V$ ,  $T_A = +25^\circ C$ .) (Note 1)

PARAMETER	SYMBOL	CONDITIONS	MIN	TYP	MAX	UNITS
<b>INTERNAL SCLK MODE</b>						
LRCLK Duty Cycle		(Note 7)		50		%
Internal SCLK Period	$t_{ISCLK}$	(Note 8)	$1/f_{SCLK}$			ns
LRCLK Edge to Internal SCLK	$t_{ISCLKR}$			$t_{ISCLK}/2$		ns
SDATA Valid to Internal SCLK Rising Setup Time	$t_{ISDS}$	MCLK period = $t_{MCLK}$	$t_{MCLK} + 10$			ns
	$t_{ISDH}$		$t_{MCLK}$			

**Note 1:** 100% production tested at  $T_A = +85^\circ C$ . Limits to  $-40^\circ C$  are guaranteed by design.

**Note 2:** 0.5 LSB of triangular PDF dither added to data.

**Note 3:** Guaranteed by design, not production tested.

**Note 4:** PSRR test block diagram shown in Figure 1 denotes the test setup used to measure PSRR.

**Note 5:** Volume ramping interval starts from establishment of a valid MCLK to LRCLK ratio. Total time is proportional to the sample rate ( $f_s$ ). 20ms based on 48ksps operation.

**Note 6:** In external SCLK mode, LRCLK duty cycles are not limited, provided all data formatting requirements are met. See Figure 4.

**Note 7:** The LRCLK duty cycle must be  $50\% \pm 1/2$  MCLK period in internal SCLK mode.

**Note 8:** The SCLK/LRCLK ratio can be set to 32, 48, or 64, depending on the MCLK/LRCLK ratio selected. See Figure 4.

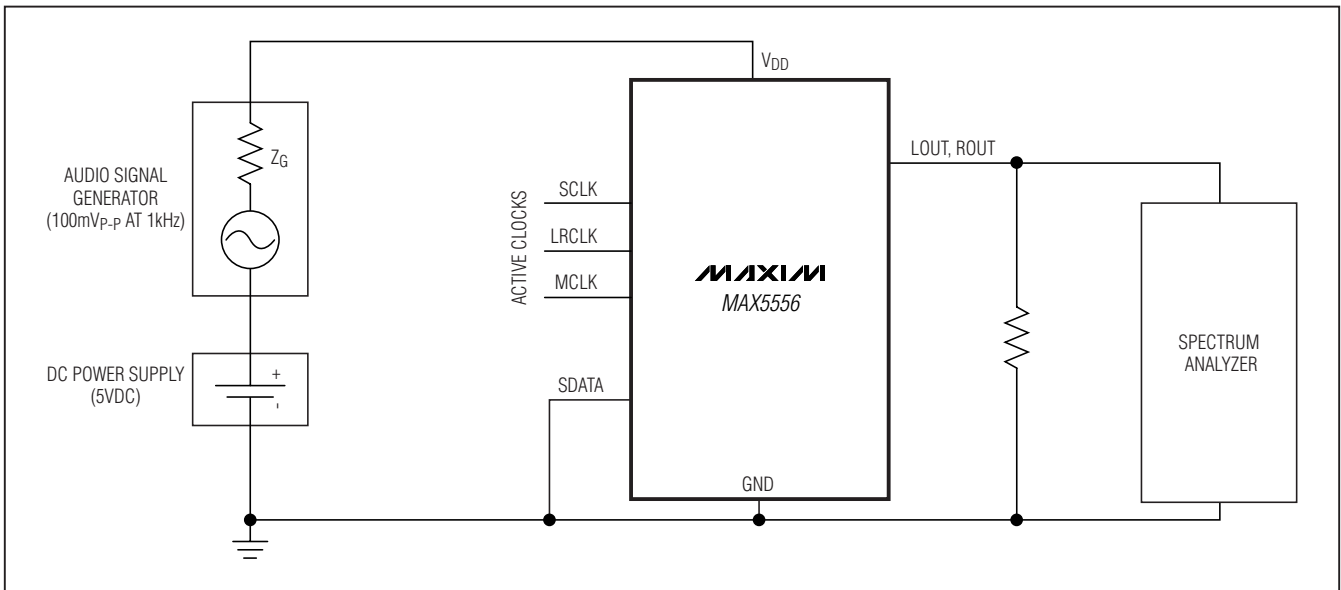

Figure 1. PSRR Test Block Diagram

# Low-Cost Stereo Audio DAC

MAX5556

## Typical Operating Characteristics

( $V_{DD} = +5V$ ,  $V_{GND} = 0V$ ,  $R_{OUT\_} = 10k\Omega$ ,  $C_{OUT\_} = 10pF$ ,  $T_A = +25^\circ C$ , unless otherwise noted.)

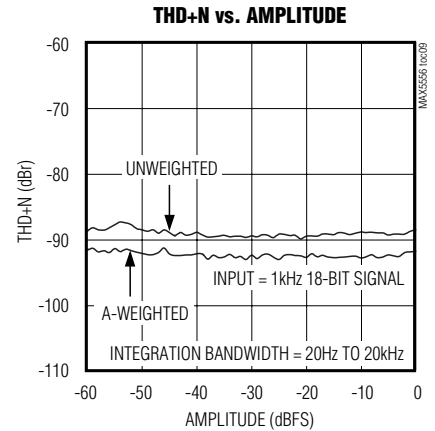
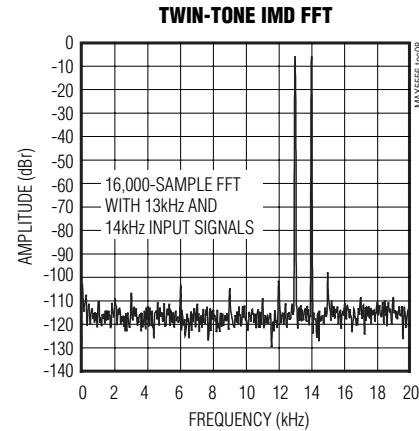
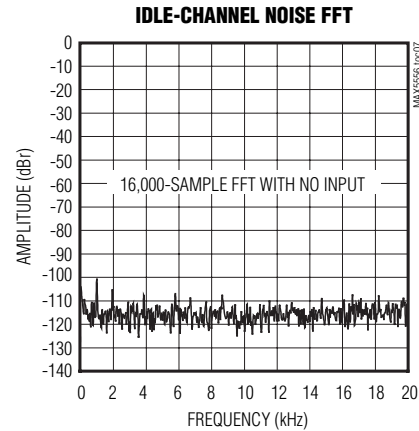
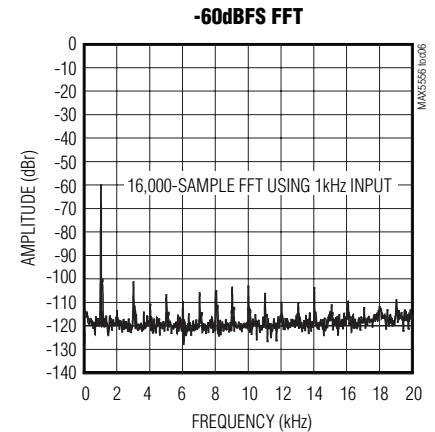
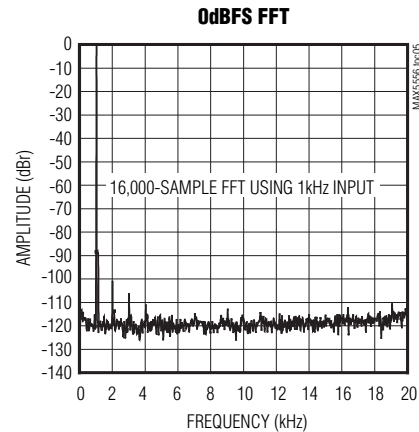
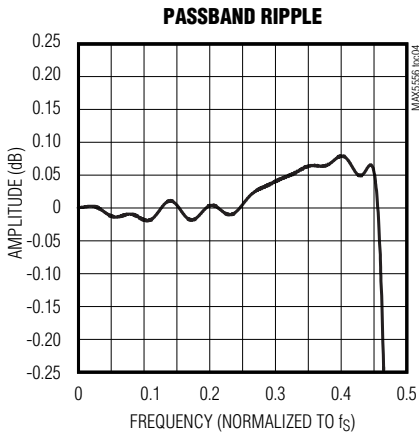
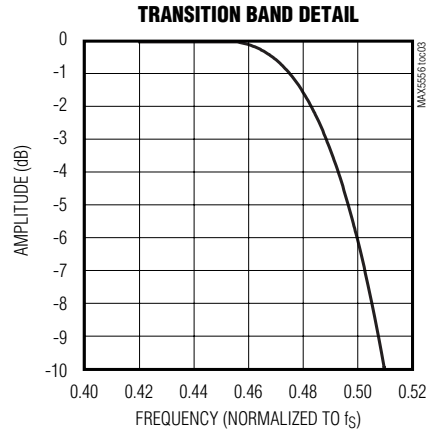
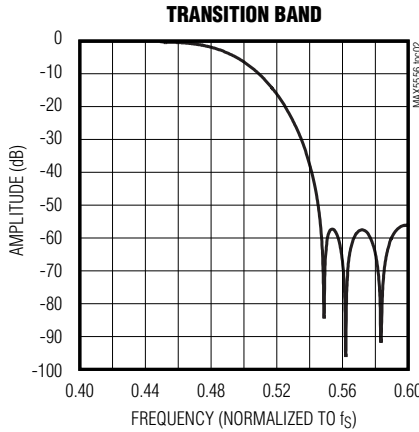
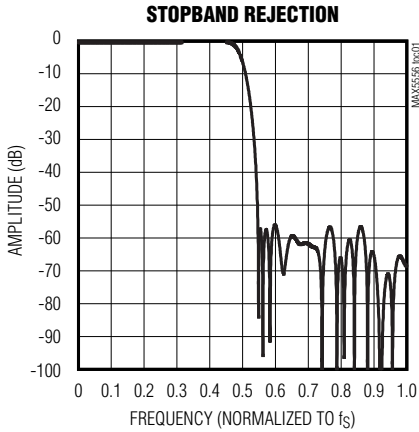

# Low-Cost Stereo Audio DAC

## Typical Operating Characteristics (continued)

( $V_{DD} = +5V$ ,  $V_{GND} = 0V$ ,  $R_{OUT\_} = 10k\Omega$ ,  $C_{OUT\_} = 10pF$ ,  $T_A = +25^\circ C$ , unless otherwise noted.)

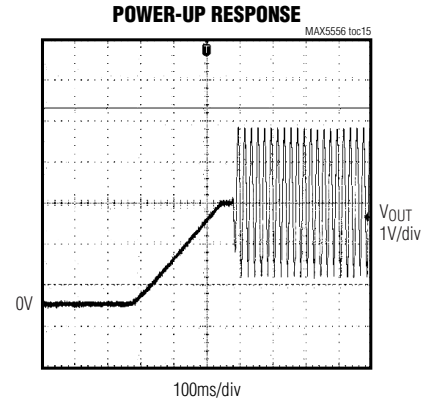
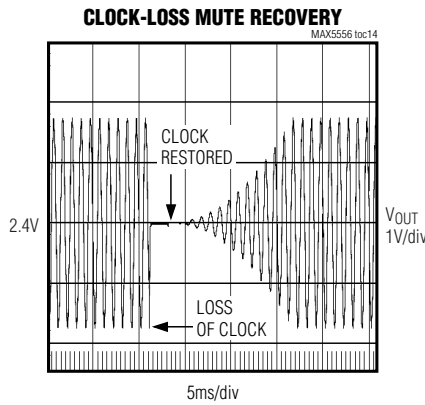
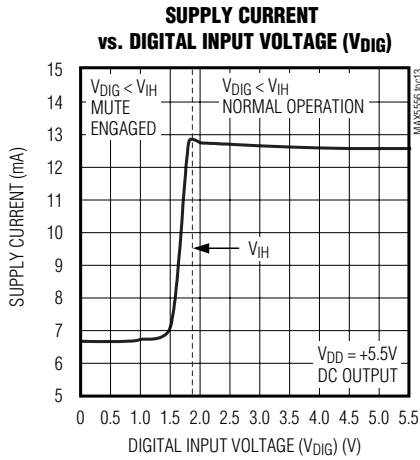
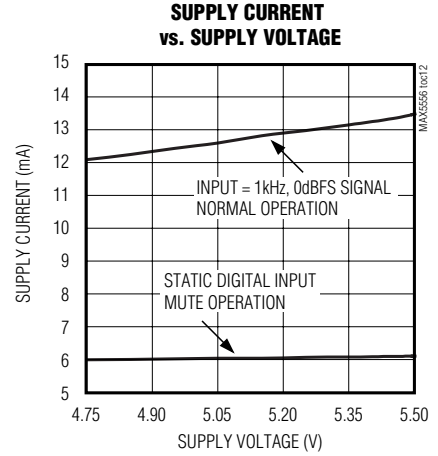
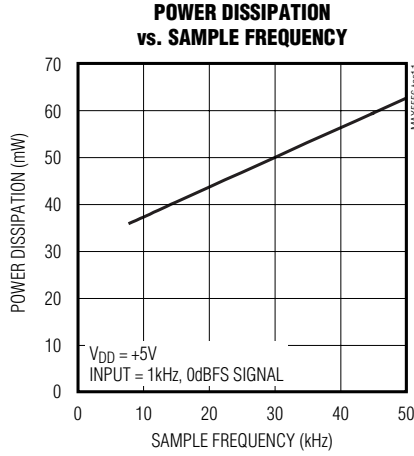
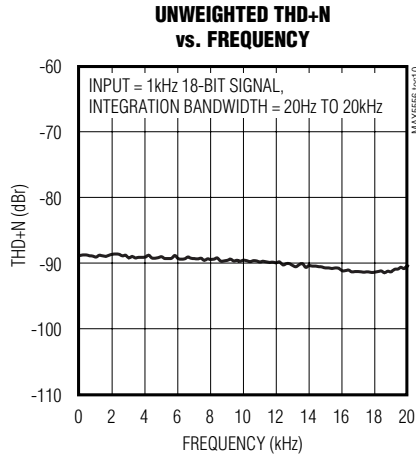

# Low-Cost Stereo Audio DAC

MAX5556

## Pin Description

PIN	NAME	FUNCTION
1	SDATA	Serial Audio Data Input. Data is clocked into the MAX5556 on the rising edge of the internal or external SCLK. Data is input in two's complement format, MSB first. The state of LRCLK determines whether data is directed to OUTL or OTR.
2	SCLK	External Serial-Clock Input. Data is strobed on the rising edge of SCLK.
3	LRCLK	Left-/Right-Channel Select Clock. Drive LRCLK low to direct data to OUTL or LRCLK high to direct data to OTR.
4	MCLK	Master Clock Input. The MCLK/LRCLK ratio must equal to 256, 384, or 512.
5	OTR	Right-Channel Analog Output
6	GND	Ground
7	V <sub>DD</sub>	Power-Supply Input. Bypass V <sub>DD</sub> to GND with a 0.1 $\mu$ F capacitor in parallel with a 4.7 $\mu$ F capacitor as close to V <sub>DD</sub> as possible. Place the 0.1 $\mu$ F capacitor closest to V <sub>DD</sub> .
8	OUTL	Left-Channel Analog Output

## Detailed Description

The MAX5556 stereo audio sigma-delta DAC offers a complete stereo digital-to-analog system for consumer audio applications. The MAX5556 features built-in digital interpolation/filtering, sigma-delta digital-to-analog conversion and analog output filters (Figure 2). Control logic and mute circuitry minimize audible pops and clicks during power-up, power-down, and whenever invalid clock conditions occur.

This stereo audio DAC receives input data over a 3-wire I<sup>2</sup>S-compatible interface. The MAX5556 accepts left-justified I<sup>2</sup>S data of 16 or 24 bits. This DAC also supports a wide range of sample rates from 2kHz to 50kHz. Direct analog output data is routed to the right or left output by driving LRCLK high or low. See the *Clock and Data Interface* section.

The MAX5556 supports MCLK/LRCLK ratios of 256, 384, or 512. This device allows a change to the clock speed ratio without causing glitches on the analog outputs by internally muting the audio during invalid clock conditions. The internal mute function ramps down the audio amplitude and forces the analog outputs to a 2.4V quiescent voltage immediately upon clock loss or

change of ratio. A soft-start routine is then engaged when a valid clock ratio is re-established, producing clickless and popless continuous operation.

The MAX5556 operates from a +4.75V to +5.5V analog supply and features +87dB dynamic range with total harmonic distortion typically below -87dB.

### Interpolator

The digital interpolation filter eliminates images of the baseband audio signal that exist at multiples of the input sample rate ( $f_s$ ). The resulting upsampled frequency spectrum has images of the input signal at multiples of  $8 \times f_s$ . An additional upsampling sinc filter further reduces upsampling images up to  $64 \times f_s$ . These images are ultimately removed through the internal analog lowpass filter and the external analog output filter.

### Sigma-Delta Modulator/DAC

The MAX5556 uses a multibit sigma-delta DAC with an oversampling ratio (OSR) of 64 to achieve a wide dynamic range. The sigma-delta modulator accepts a 3-bit data stream from the interpolation filter at a rate of  $64 \times f_s$  ( $f_s =$  LRCLK frequency) and provides an analog voltage representation of that data stream.

# Low-Cost Stereo Audio DAC

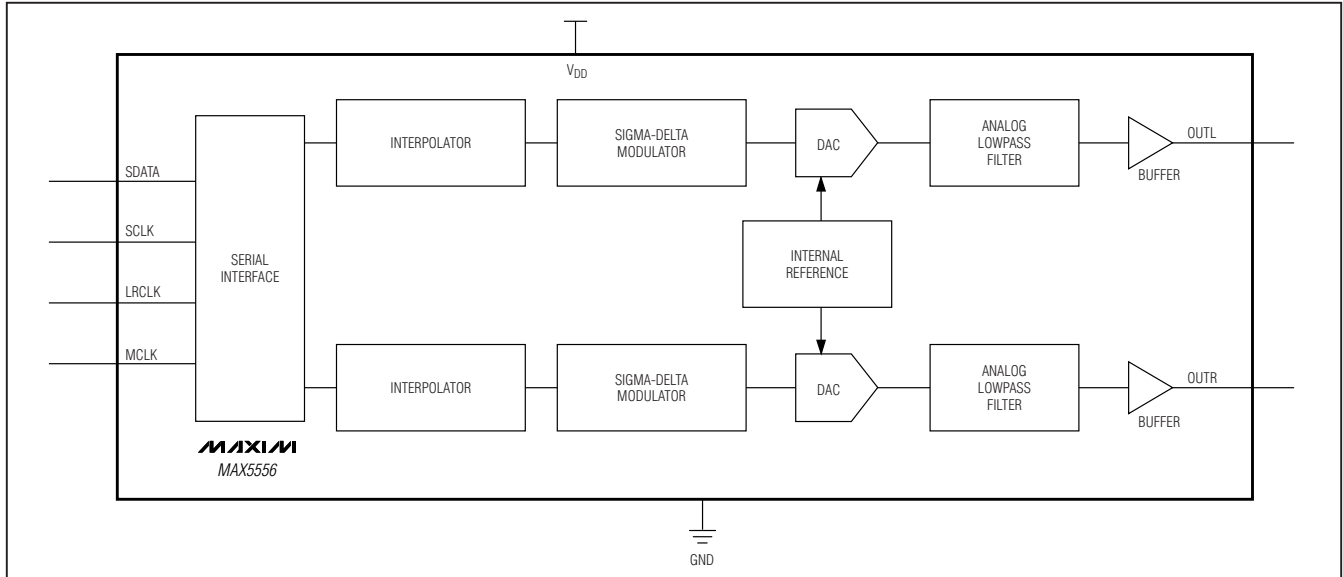

Figure 2. Functional Diagram



Figure 3. Load-Impedance Operating Region

### Integrated Analog Lowpass Filter

The DAC output of the sigma-delta modulator is followed by an analog smoothing filter that attenuates high-frequency quantization noise. The corner frequency of the filter is approximately  $2 \times f_s$ .

### Integrated Analog Output Buffer

Following the analog lowpass filter, the analog signal is routed through internal buffers to OURL and OUTL. The buffer can directly drive load resistances larger than  $3k\Omega$  and load capacitances up to  $100pF$  (Figure 3).



# Low-Cost Stereo Audio DAC

## Clock and Data Interface

The MAX5556 strobes serial data (SDATA) in on the rising edge of SCLK. LRCLK routes data to the left or right outputs and, along with SCLK, defines the number of bits per sample transferred. The digital interpolators filter data at internal clock rates derived from the MCLK frequency. Each device supports both internal and external serial clock (SCLK) modes.

### SDATA Input

The serial interface strobes data (SDATA) in on the rising edge of SCLK, MSB first. The MAX5556 supports four different data formats, as detailed in Figure 4.

## Serial Clock (SCLK)

SCLK strobes the individual data bits at SDATA into the DAC. The MAX5556 operates in one of two modes: internal serial clock mode or external serial clock mode.

### External SCLK Mode

The MAX5556 operates in external serial clock mode when SCLK activity is detected. The device returns to internal serial clock mode if no SCLK signal is detected for one LRCLK period. Figure 5 details the external serial clock mode timing parameters.

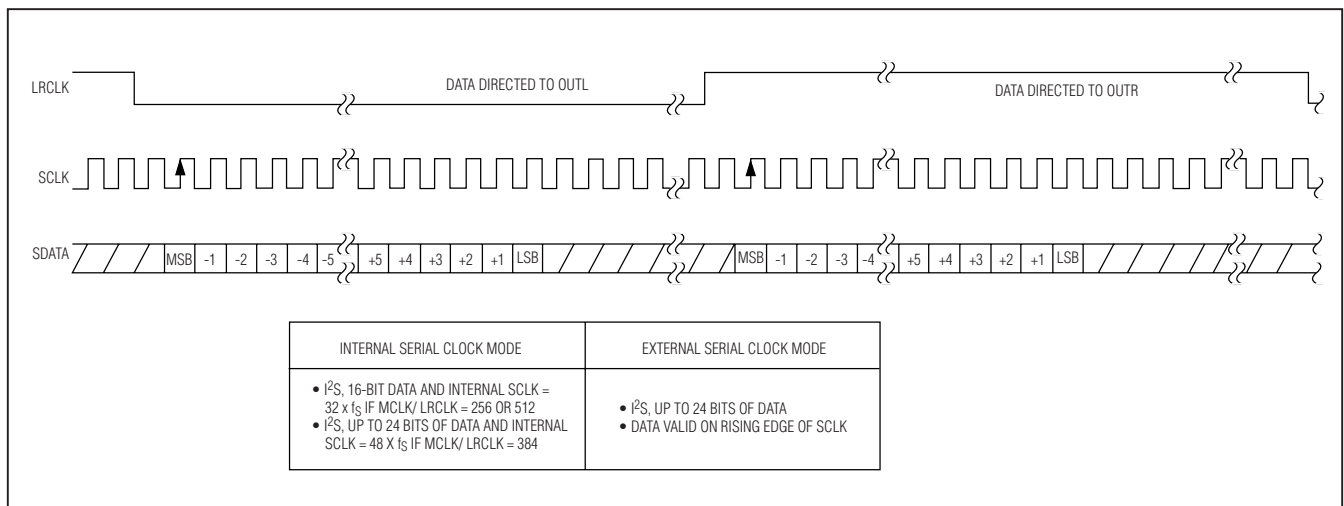

Figure 4. MAX5556 Data Format Timing

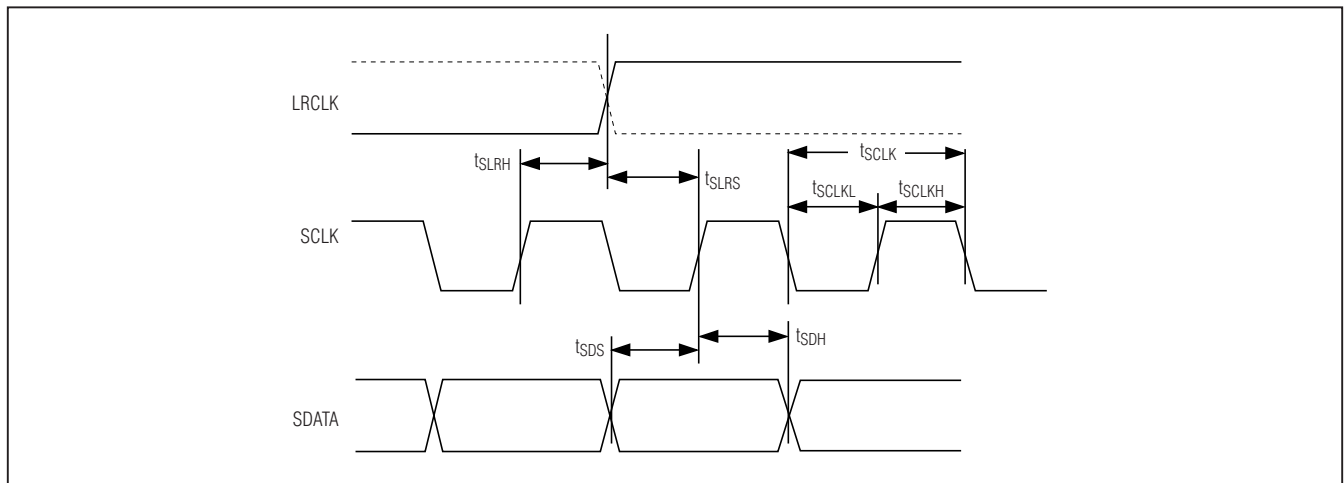

Figure 5. External SCLK Serial Timing Diagram

# Low-Cost Stereo Audio DAC

## Internal SCLK Mode

The MAX5556 transitions from external serial clock mode to internal serial clock mode if no SCLK signal is detected for one LRCLK period. In internal clock mode, SCLK is derived from and is synchronous with MCLK

and LRCLK (operation in internal clock mode is identical to an external clock mode when LRCLK is synchronized with MCLK). Figure 6 details the internal serial clock mode timing parameters. Figure 7 details the generation of the internal clock.

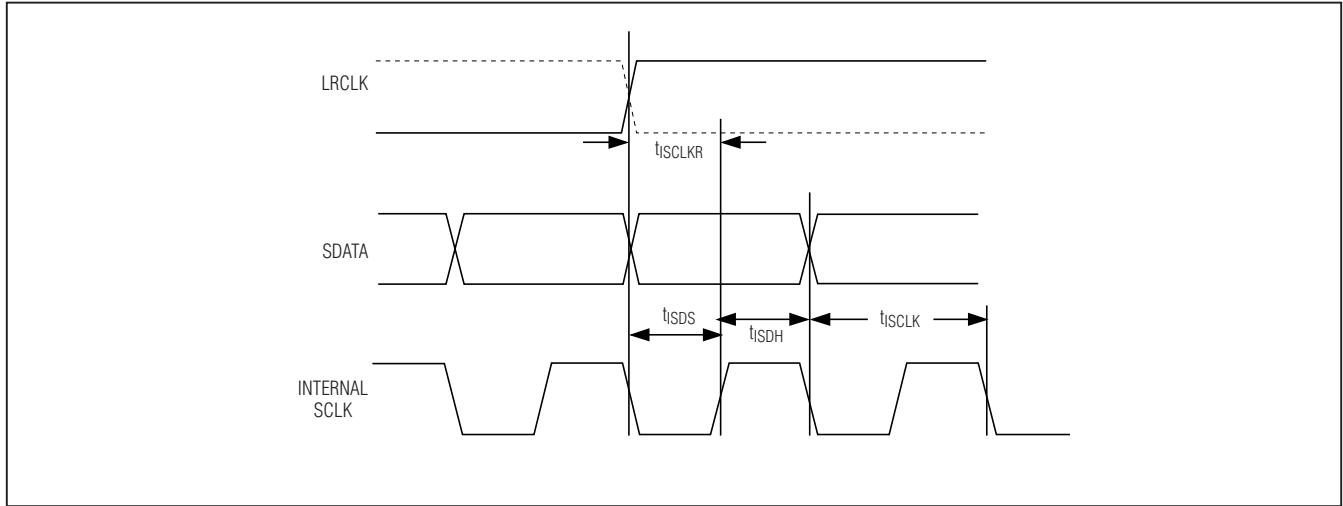

Figure 6. Internal SCLK Serial Timing Diagram

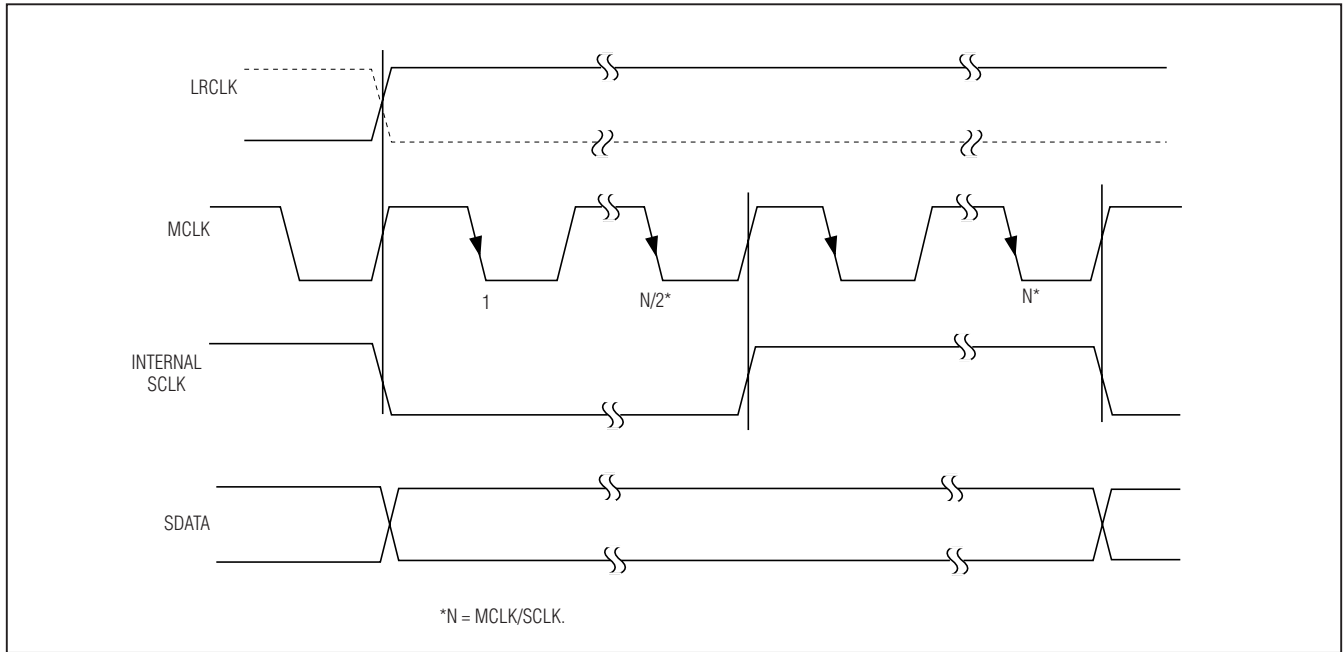

Figure 7. Internal Serial Clock Generation

# Low-Cost Stereo Audio DAC

## Left/Right Clock Input (LRCLK)

LRCLK is the left/right clock input signal for the 3-wire interface and sets the sample frequency ( $f_s$ ). On the MAX5556, drive LRCLK low to direct data to OUTL or LRCLK high to direct data to OUTF (Figure 4). The MAX5556 accepts data at LRCLK audio sample rates from 2kHz to 50kHz.

## Master Clock (MCLK)

MCLK accepts the master clock signal from an external clocking device and is used to derive internal clock frequencies. Set the MCLK/LRCLK ratio to 256, 384, or 512 to achieve the internal serial clock frequencies listed in Table 1. Table 2 details the MCLK/LRCLK ratios for three sample audio rates.

The MAX5556 detects the MCLK/LRCLK ratio during the initialization sequence by counting the number of MCLK transitions during a single LRCLK period. MCLK, SCLK, and LRCLK must be synchronous signals.

**Table 1. Internal and External Clock Frequencies**

INTERNAL SERIAL CLOCK FREQUENCY		EXTERNAL SERIAL CLOCK FREQUENCY
MCLK/LRCLK = 256 OR 512	MCLK/LRCLK = 384	
32 x $f_s$	48 x $f_s$	User defined (Figure 4)

**Table 2. MCLK/LRCLK Ratios**

LRCLK (kHz)	MCLK (MHz)		
	MCLK/LRCLK = 256	MCLK/LRCLK = 384	MCLK/LRCLK = 512
32	8.1920	12.2880	16.3840
44.1	11.2896	16.9344	22.5792
48	12.2880	18.4320	24.5760

## Data Formats

### MAX5556 I<sup>2</sup>S Left-Justified Data Format

The MAX5556 accepts data with an I<sup>2</sup>S left-justified data format, accepting 16 or 24 bits of data. SDATA accepts data in two's complement format with the MSB first. The MSB is valid on the second SCLK rising edge after LRCLK transitions low to high or high to low (Figure 4). Drive LRCLK low to direct data to OUTL. Drive LRCLK high to direct data to OUTF. The number of SCLK pulses with LRCLK high or low determines the number of bits transferred per sample. If fewer than 24 bits of data are written, the remaining LSBs are set to 0. If more than 24 bits are written, any bits after the LSB are ignored.

The MAX5556 accepts up to 24 bits of data in external serial clock mode or when the MCLK/LRCLK ratio is 384 (internal serial clock = 48 x  $f_s$ ) in internal serial clock mode. The DAC also accepts 16 bits of data in internal serial clock mode when the MCLK/LRCLK ratio is 256 or 512 (internal serial clock = 32 x  $f_s$ ).

### External Analog Filter

Use an external lowpass analog filter to further reduce harmonic images, noise, and spurs. The external analog filter can be either active or passive depending upon performance and design requirements. For example filters, see Figures 8 and 9 and the *Applications Information* section. Careful attention should be paid when selecting capacitors for audio signal path applications. NPO and C0G types are recommended as are aluminum electrolytics and low-ESR tantalum varieties. Use of generic ceramic types is not recommended and may result in degraded THD performance. Always consult manufacturers' data sheets and applications information.

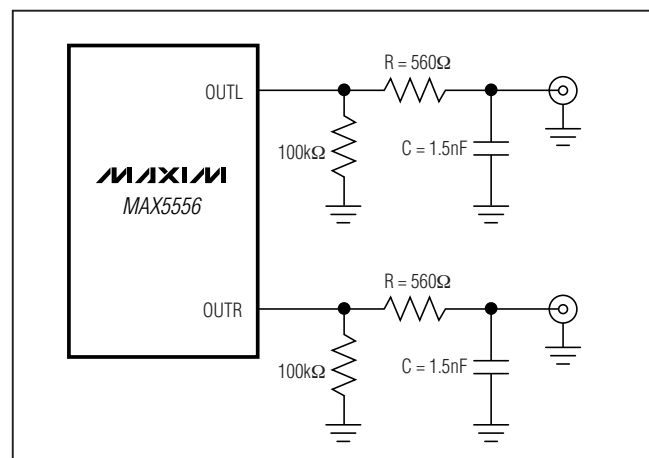

Figure 8. Passive Component Analog Output Filter

# Low-Cost Stereo Audio DAC

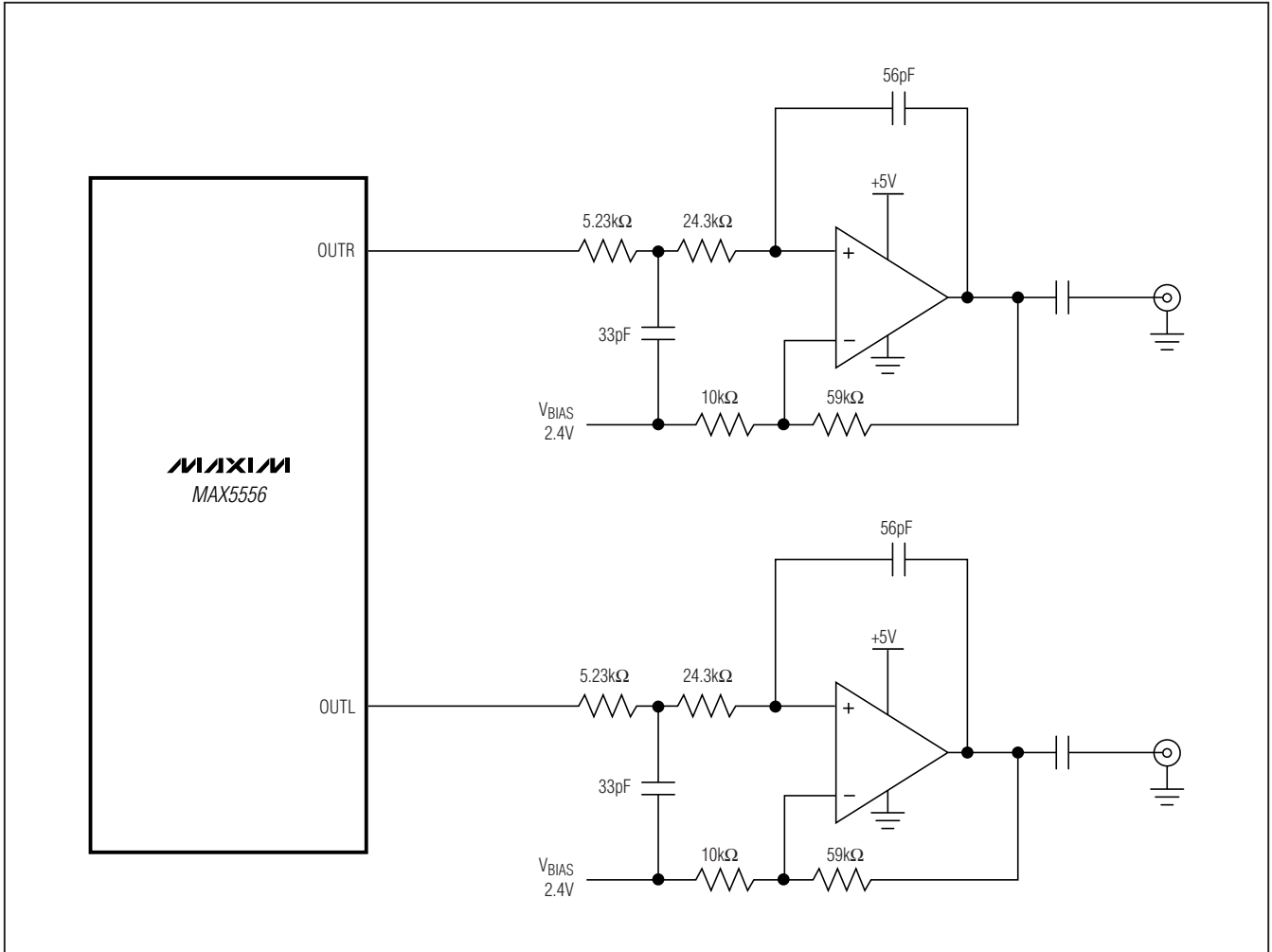

Figure 9. Active Component Analog Output Filter

# Low-Cost Stereo Audio DAC

## Pop and Click Suppression

The MAX5556 features a pop and click suppression routine to reduce the unwanted audible effects of system transients. This routine produces glitch-free operation

at the outputs during power-on, loss of clock, or invalid clock conditions. See Figure 10 for a detailed state diagram during transient conditions.

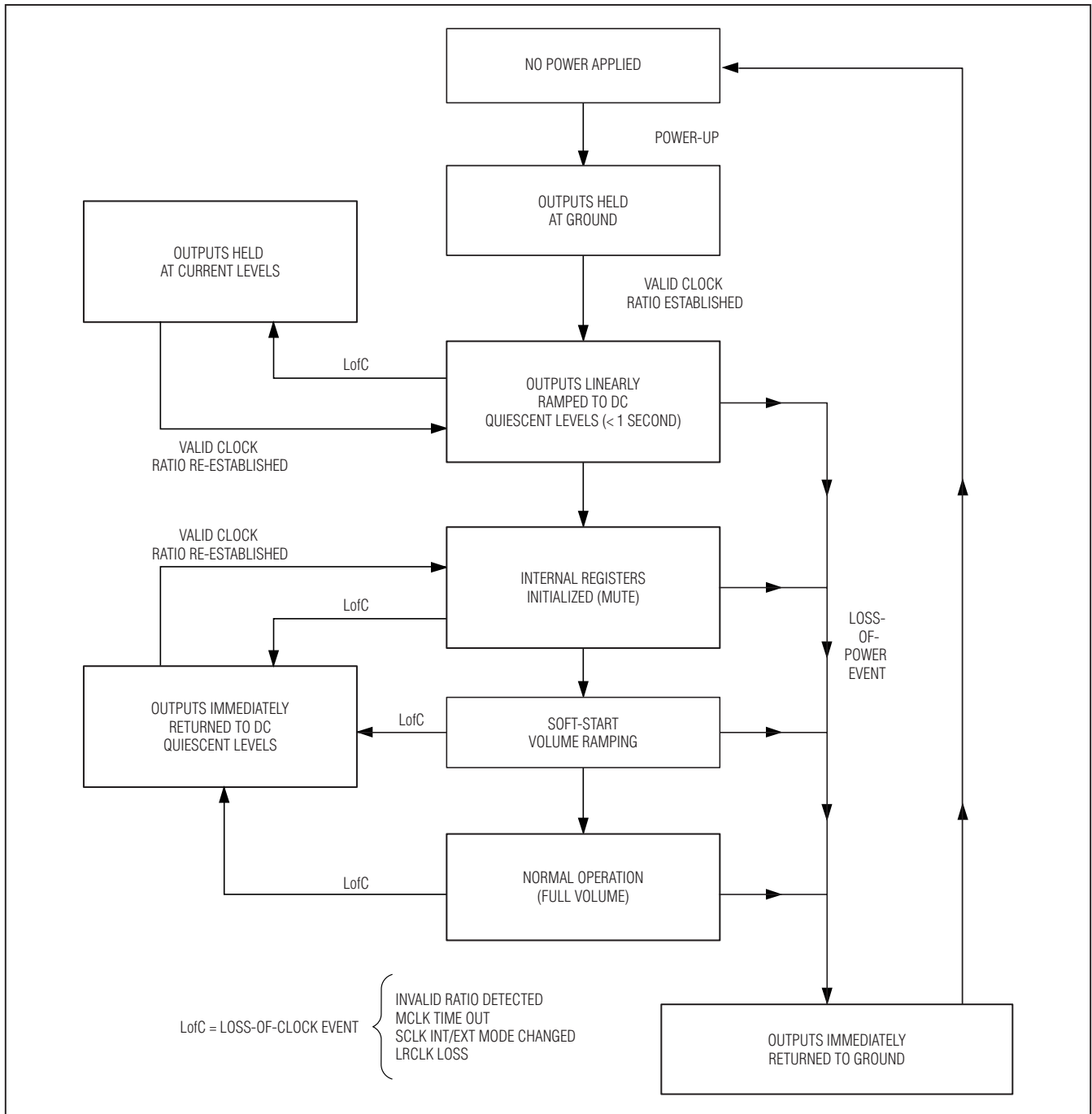

Figure 10. Internal State Diagram

## Low-Cost Stereo Audio DAC

### Power-Up

Once the MAX5556 recognizes a valid MCLK/LRCLK ratio (256, 384, or 512), the analog outputs (OUTR and OUTL) are enabled in stages using a glitchless ramping routine. First, the outputs ramp up to the quiescent output voltage at a rate of 5V/s typ (see Figure 11). After the outputs reach the quiescent voltage, the converted data

stream begins soft-start ramping, achieving the full-scale operation over a 20ms period.

If invalid clock signals are detected while the outputs are DC ramping to their quiescent state, the outputs stop ramping and hold their preset values until valid clock signals are restored (Figure 12).

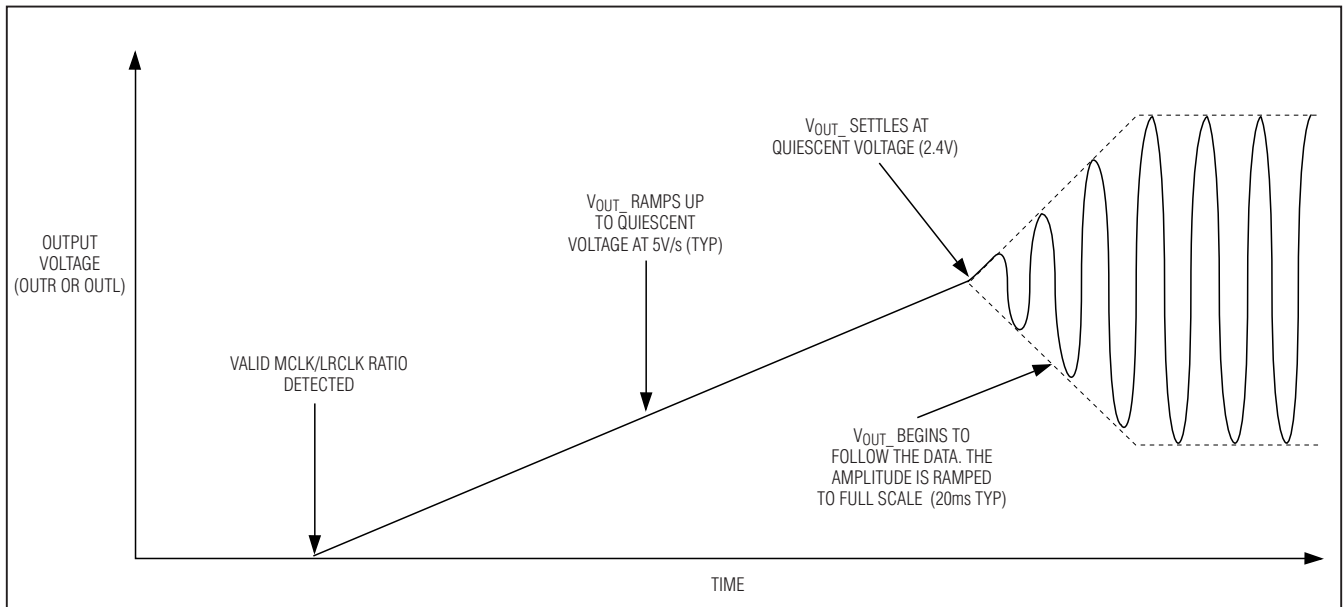

Figure 11. Power-Up Sequence

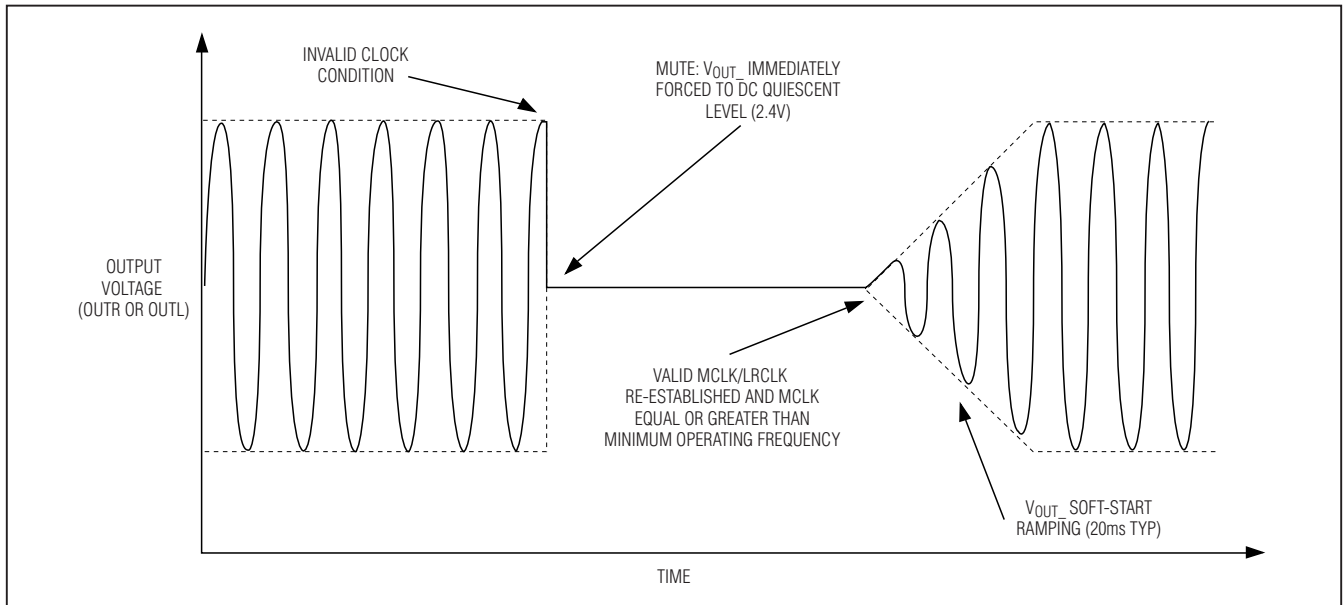

Figure 12. Invalid Clock Output Response

# Low-Cost Stereo Audio DAC

## Loss of Clock and Invalid Clock Conditions

The MAX5556 mutes both outputs after detecting one of four invalid clock conditions. The device mutes its output to prevent propagation of pops, clicks, or corrupted data through the signal path. The MAX5556 forces the outputs to the quiescent DC voltage (2.4V) to prevent clicks in capacitive-coupled systems. Invalid clock conditions include:

- 1) MCLK/LRCLK ratio changes between 256, 384, and 512
- 2) Transition between internal and external serial-clock mode
- 3) Invalid MCLK/LRCLK ratio
- 4) MCLK falls below the minimum operating frequency 2kHz

When the MCLK/LRCLK ratio returns to 256, 384, or 512 and MCLK is equal or greater than its minimum operating frequency, the MAX5556 output returns to its full-scale setting over a soft-start mute time of 20ms (Figure 12).

## Power-Down

When the positive supply is removed from the MAX5556, the output discharges to ground. When power is restored, the power-up ramp routine engages once a valid clock ratio is established (see the *Power-Up* section).

Avoid violating absolute maximum conditions by supplying digital inputs to the part or forcing voltages on the analog outputs during a loss-of-power event.

## Applications Information

### Low-Cost Line-Level Solution

Connect the MAX5556 output through a passive output filter as detailed in Figure 8 for a low-cost solution. This lowpass filter yields single-pole (20dB/decade) roll-off at a corner frequency ( $f_c$ ) determined by:

$$f_c = \frac{1}{2\pi RC}$$

In the case of Figure 8,  $f_c$  is approximately 190kHz.

## High-Performance Line-Level Solution

For enhanced performance, connect the MAX5556 output to an active filter by using an operational amplifier as shown in Figure 9. The use of an active filter allows for steeper roll-off, more efficient filtering, and also adds the capability of a programmable output gain.

## Power-Supply Sequencing

For correct power-up sequencing, apply  $V_{DD}$  and then connect the input digital signals. Do not apply digital signals before  $V_{DD}$  is applied.

Do not violate any of the absolute maximum ratings by removing power with the digital inputs still connected. To correctly power down the device, first disconnect the digital input signals, and then remove  $V_{DD}$ .

## Power-Supply Connections and Ground Management

Proper layout and grounding are essential for optimum performance. Use large traces for the power-supply inputs and analog outputs to minimize losses due to parasitic trace resistance. Large traces also aid in moving heat away from the package. Proper grounding improves audio performance, minimizes crosstalk between channels, and prevents any switching noise from coupling into the audio signal. Route the analog paths (GND,  $V_{DD}$ , OUTL, and OUTR) away from the digital signals. Connect a 0.1 $\mu$ F capacitor in parallel with a 4.7 $\mu$ F capacitor as close to  $V_{DD}$  as possible. Low ESR-type capacitors are recommended for supply decoupling applications. A small value C0G-type bypass capacitor located as close to the device as possible is recommended in parallel with larger values.

# Low-Cost Stereo Audio DAC

## Chip Information

PROCESS: BiCMOS

## Package Information

For the latest package outline information and land patterns (footprints), go to [www.maxim-ic.com/packages](http://www.maxim-ic.com/packages). Note that a "+", "#", or "-" in the package code indicates RoHS status only. Package drawings may show a different suffix character, but the drawing pertains to the package regardless of RoHS status.

PACKAGE TYPE	PACKAGE CODE	OUTLINE NO.	LAND PATTERN NO.
8 SO	S8+5	<a href="#">21-0041</a>	<a href="#">90-0096</a>



# Low-Cost Stereo Audio DAC

## Revision History

REVISION NUMBER	REVISION DATE	DESCRIPTION	PAGES CHANGED
0	5/06	Initial release	—
1	2/11	Added lead-free and automotive information, updated the <i>Absolute Maximum Ratings</i> , removed all references to unreleased products MAX5557/MAX5558/MAX5559, updated the <i>Typical Operating Circuit</i> .	1–4, 7–19

MAX5556

Maxim cannot assume responsibility for use of any circuitry other than circuitry entirely embodied in a Maxim product. No circuit patent licenses are implied. Maxim reserves the right to change the circuitry and specifications without notice at any time.

**Maxim Integrated Products, 120 San Gabriel Drive, Sunnyvale, CA 94086 408-737-7600** \_\_\_\_\_ 17

© 2011 Maxim Integrated Products

Maxim is a registered trademark of Maxim Integrated Products, Inc.