



N-Channel 60-V (D-S) MOSFET

PRODUCT SUMMARY				
Part Number	$V_{(BR)DSS}$ Min (V)	$r_{DS(on)}$ Max (Ω)	$V_{GS(th)}$ (V)	I_D (A)
2N7000	60	5 @ $V_{GS} = 10$ V	0.8 to 3	0.2
2N7002		7.5 @ $V_{GS} = 10$ V	1 to 2.5	0.115
VQ1000J		5.5 @ $V_{GS} = 10$ V	0.8 to 2.5	0.225
VQ1000P		5.5 @ $V_{GS} = 10$ V	0.8 to 2.5	0.225
BS170		5 @ $V_{GS} = 10$ V	0.8 to 3	0.5

FEATURES

- Low On-Resistance: 2.5 Ω
- Low Threshold: 2.1 V
- Low Input Capacitance: 22 pF
- Fast Switching Speed: 7 ns
- Low Input and Output Leakage

BENEFITS

- Low Offset Voltage
- Low-Voltage Operation
- Easily Driven Without Buffer
- High-Speed Circuits
- Low Error Voltage

APPLICATIONS

- Direct Logic-Level Interface: TTL/CMOS
- Drivers: Relays, Solenoids, Lamps, Hammers, Displays, Memories, Transistors, etc.
- Battery Operated Systems
- Solid-State Relays

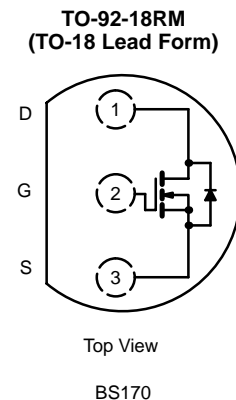
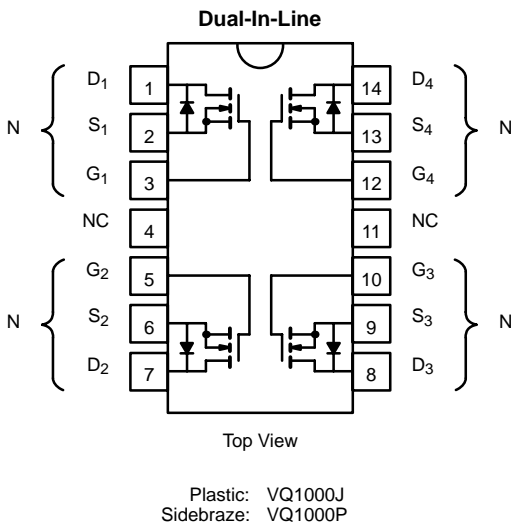
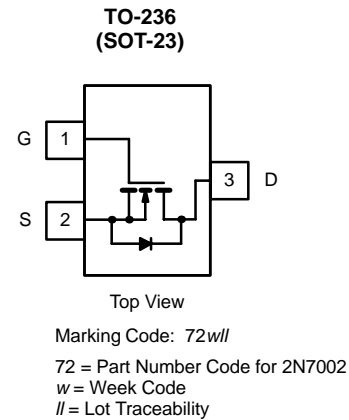
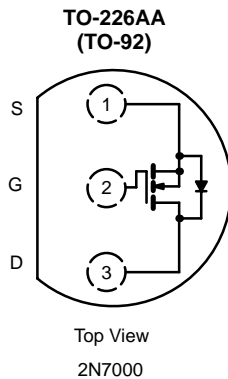



ABSOLUTE MAXIMUM RATINGS (T _A = 25 °C UNLESS OTHERWISE NOTED)									
Parameter	Symbol	2N7000	2N7002	Single		Total Quad	BS170	Unit	
				VQ1000J	VQ1000P	VQ1000J/P			
Drain-Source Voltage	V _{DS}	60	60	60	60		60	V	
Gate-Source Voltage—Non-Repetitive	V _{GSM}	±40	±40	±30			±25		
Gate-Source Voltage—Continuous	V _{GS}	±20	±20	±20	±20		±20		
Continuous Drain Current (T _J = 150 °C)	T _A = 25 °C	I _D	0.2	0.115	0.225	0.225		0.5	A
	T _A = 100 °C		0.13	0.073	0.14	0.14		0.175	
Pulsed Drain Current ^a	I _{DM}	0.5	0.8	1	1				
Power Dissipation	T _A = 25 °C	P _D	0.4	0.2	1.3	1.3	2	0.83	W
	T _A = 100 °C		0.16	0.08	0.52	0.52	0.8		
Thermal Resistance, Junction-to-Ambient	R _{thJA}	312.5	625	96	96	62.5	156	°C/W	
Operating Junction and Storage Temperature Range	T _J , T _{stg}	-55 to 150							°C

Notes

- a. Pulse width limited by maximum junction temperature.
- b. t_p ≤ 50 μs.

SPECIFICATIONS—2N7000 AND 2N7002 (T _A = 25 °C UNLESS OTHERWISE NOTED)								
Parameter	Symbol	Test Conditions	Typ ^a	Limits				Unit
				2N7000		2N7002		
				Min	Max	Min	Max	
Static								
Drain-Source Breakdown Voltage	V _{(BR)DSS}	V _{GS} = 0 V, I _D = 10 μA	70	60		60		V
Gate-Threshold Voltage	V _{GS(th)}	V _{DS} = V _{GS} , I _D = 1 mA	2.1	0.8	3			
		V _{DS} = V _{GS} , I _D = 0.25 mA	2.0			1	2.5	
Gate-Body Leakage	I _{GSS}	V _{DS} = 0 V, V _{GS} = ±15 V			±10			nA
		V _{DS} = 0 V, V _{GS} = ±20 V					±100	
Zero Gate Voltage Drain Current	I _{DSS}	V _{DS} = 48 V, V _{GS} = 0 V			1			μA
		T _C = 125 °C			1000			
		V _{DS} = 60 V, V _{GS} = 0 V					1	
On-State Drain Current ^b	I _{D(on)}	V _{DS} = 10 V, V _{GS} = 4.5 V	0.35	0.075				A
		V _{DS} = 7.5 V, V _{GS} = 10 V	1			0.5		
		V _{GS} = 4.5 V, I _D = 0.075 A	4.5		5.3			
Drain-Source On-Resistance ^b	r _{DS(on)}	V _{GS} = 5 V, I _D = 0.05 A	3.2				7.5	Ω
		T _C = 125 °C	5.8				13.5	
		V _{GS} = 10 V, I _D = 0.5 A	2.4		5		7.5	
		T _J = 125 °C	4.4		9		13.5	
Forward Transconductance ^b	g _{fs}	V _{DS} = 10 V, I _D = 0.2 A		100		80		mS
Common Source Output Conductance ^b	g _{os}	V _{DS} = 5 V, I _D = 0.05 A	0.5					
Dynamic								
Input Capacitance	C _{iss}	V _{DS} = 25 V, V _{GS} = 0 V f = 1 MHz	22		60		50	pF
Output Capacitance	C _{oss}		11		25		25	
Reverse Transfer Capacitance	C _{rss}		2		5		5	



SPECIFICATIONS—2N7000 AND 2N7002 (T _A = 25 °C UNLESS OTHERWISE NOTED)								
Parameter	Symbol	Test Conditions	Typ ^a	Limits				Unit
				2N7000		2N7002		
				Min	Max	Min	Max	
Switching^d								
Turn-On Time	t _{ON}	V _{DD} = 15 V, R _L = 25 Ω I _D ≅ 0.5 A, V _{GEN} = 10 V, R _G = 25 Ω	7		10			ns
Turn-Off Time	t _{OFF}		7		10			
Turn-On Time	t _{ON}	V _{DD} = 30 V, R _L = 150 Ω I _D ≅ 0.2 A, V _{GEN} = 10 V, R _G = 25 Ω	7				20	
Turn-Off Time	t _{OFF}		11				20	

SPECIFICATIONS—VQ1000J/P AND BS170 (T _A = 25 °C UNLESS OTHERWISE NOTED)								
Parameter	Symbol	Test Conditions	Typ ^a	Limits				Unit
				VQ1000J/P		BS170		
				Min	Max	Min	Max	
Static								
Drain-Source Breakdown Voltage	V _{(BR)DSS}	V _{GS} = 0 V, I _D = 100 μA	70	60		60		V
Gate-Threshold Voltage	V _{GS(th)}	V _{DS} = V _{GS} , I _D = 1 mA	2.1	0.8	2.5	0.8	3	
Gate-Body Leakage	I _{GSS}	V _{DS} = 0 V, V _{GS} = ±10 V			±100			nA
		T _J = 125 °C			±500			
Zero Gate Voltage Drain Current	I _{DSS}	V _{DS} = 0 V, V _{GS} = ±15 V					±10	μA
		V _{DS} = 25 V, V _{GS} = 0 V					0.5	
		V _{DS} = 48 V, V _{GS} = 0 V, T _J = 125 °C			500			
On-State Drain Current ^b	I _{D(on)}	V _{DS} = 10 V, V _{GS} = 10 V	1	0.5				A
		V _{GS} = 5 V, I _D = 0.2 A	4		7.5			Ω
Drain-Source On-Resistance ^b	r _{DS(on)}	V _{GS} = 10 V, I _D = 0.2 A	2.3				5	
		V _{GS} = 10 V, I _D = 0.3 A	2.3		5.5			
		T _J = 125 °C	4.2		7.6			
		V _{DS} = 10 V, I _D = 0.2 A				100		mS
Forward Transconductance ^b	g _{fs}	V _{DS} = 10 V, I _D = 0.5 A		100				
Common Source Output Conductance ^b	g _{os}	V _{DS} = 5 V, I _D = 0.05 A	0.5					
Dynamic								
Input Capacitance	C _{iSS}	V _{DS} = 25 V, V _{GS} = 0 V f = 1 MHz	22		60		60	pF
Output Capacitance	C _{oss}		11		25			
Reverse Transfer Capacitance	C _{rSS}		2		5			
Switching^d								
Turn-On Time	t _{ON}	V _{DD} = 15 V, R _L = 23 Ω I _D ≅ 0.6 A, V _{GEN} = 10 V, R _G = 25 Ω	7		10			ns
Turn-Off Time	t _{OFF}		7		10			
Turn-On Time	t _{ON}	V _{DD} = 25 V, R _L = 125 Ω I _D ≅ 0.2 A, V _{GEN} = 10 V, R _G = 25 Ω	7				10	
Turn-Off Time	t _{OFF}		7				10	

Notes

- a. For DESIGN AID ONLY, not subject to production testing.
- b. Pulse test: PW ≤ 80 μs duty cycle ≤ 1%.
- c. This parameter not registered with JEDEC.
- d. Switching time is essentially independent of operating temperature.

VNBF06

TYPICAL CHARACTERISTICS ($T_A = 25^\circ\text{C}$ UNLESS OTHERWISE NOTED)

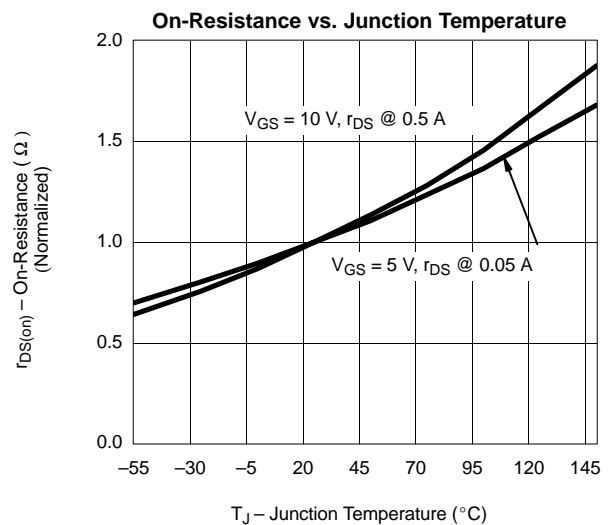
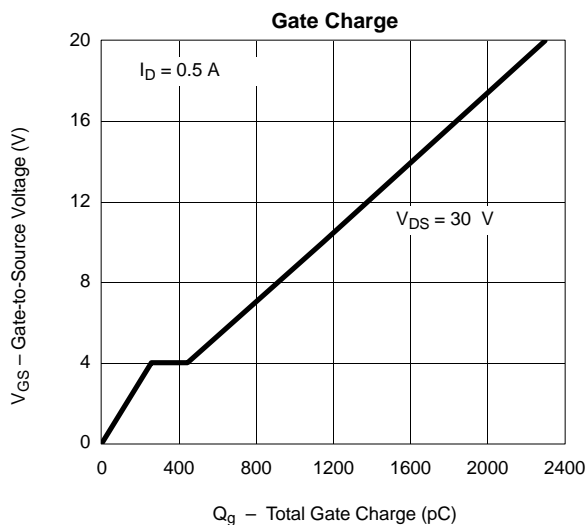
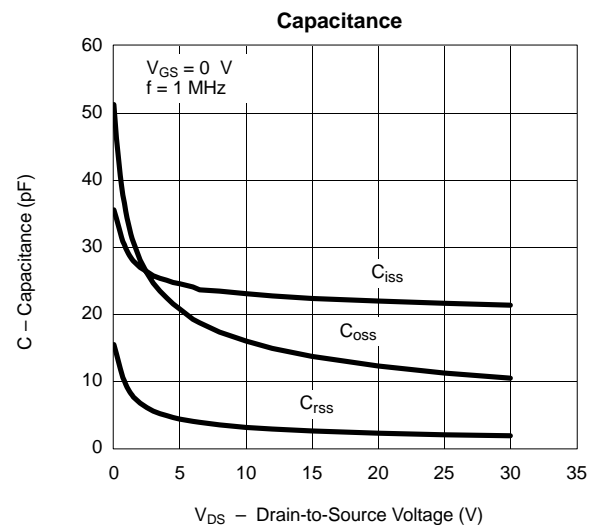
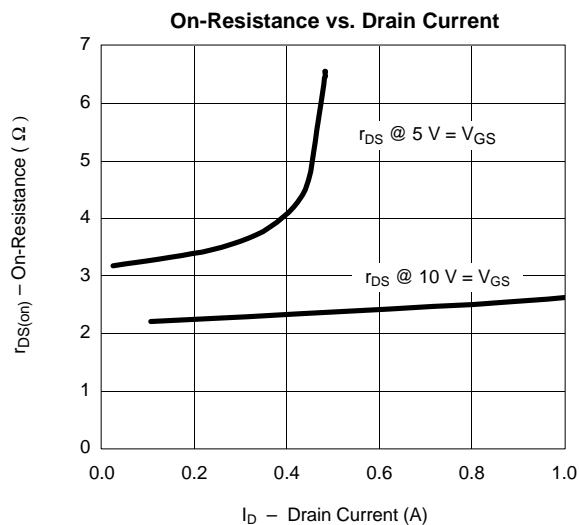
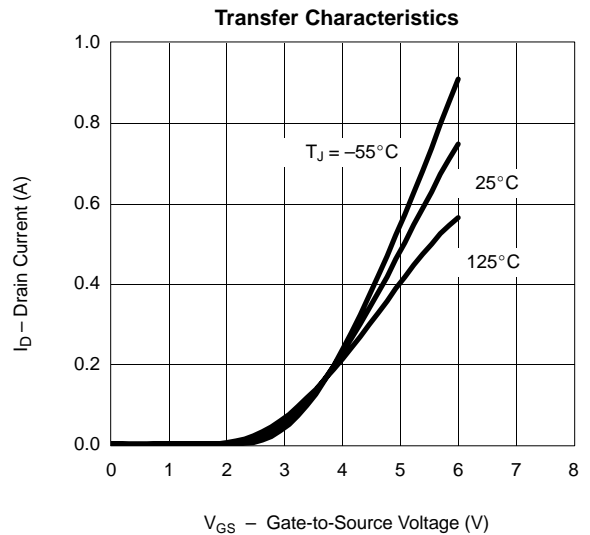
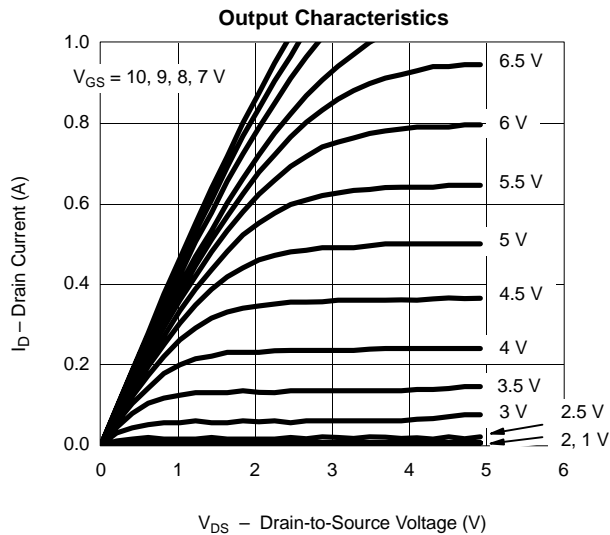



TYPICAL CHARACTERISTICS ($T_A = 25^\circ\text{C}$ UNLESS OTHERWISE NOTED)

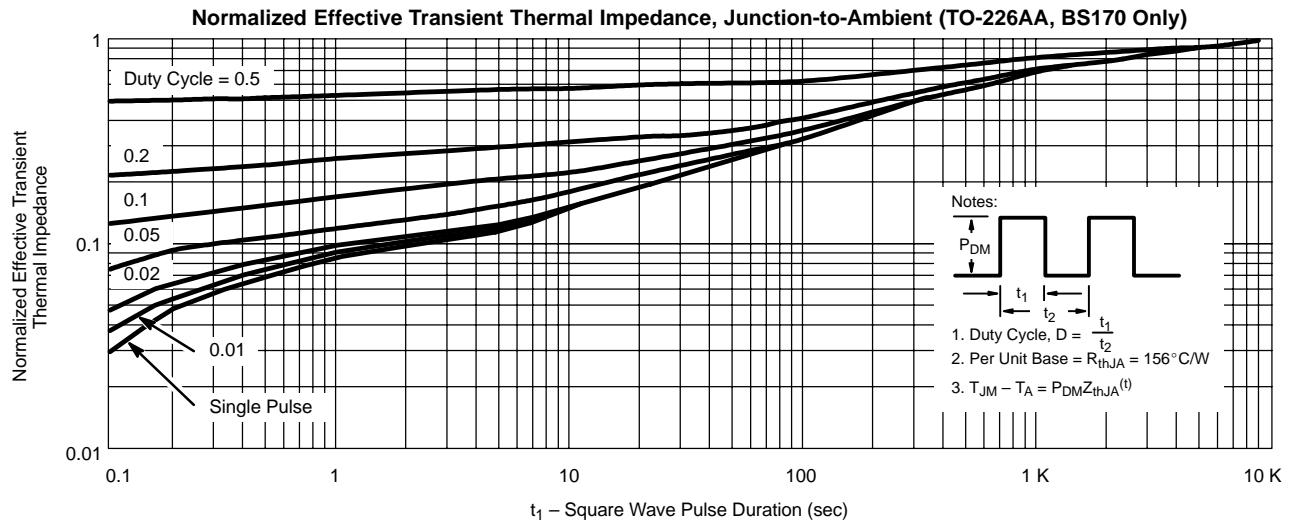
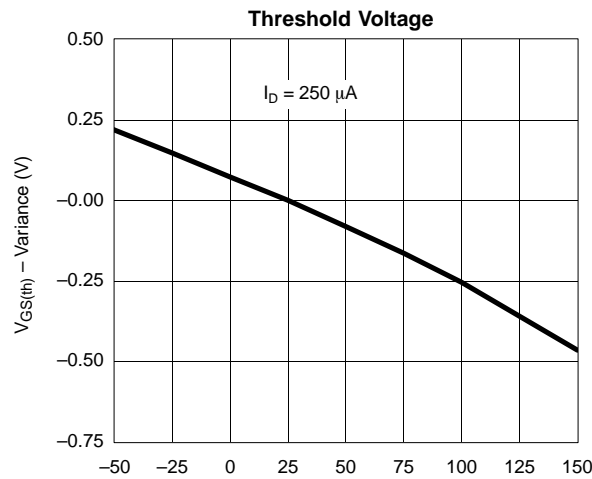
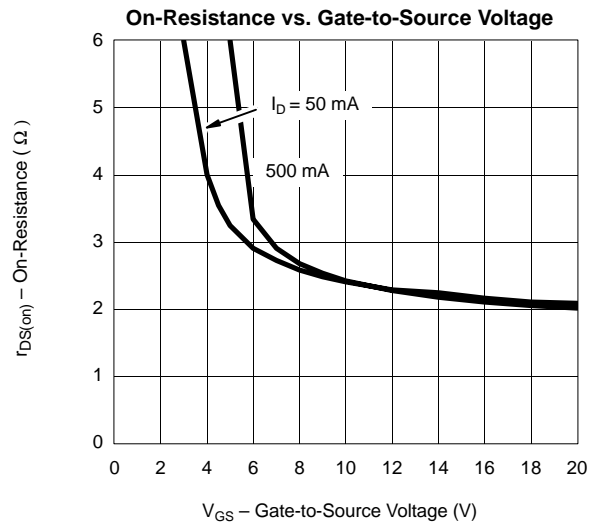
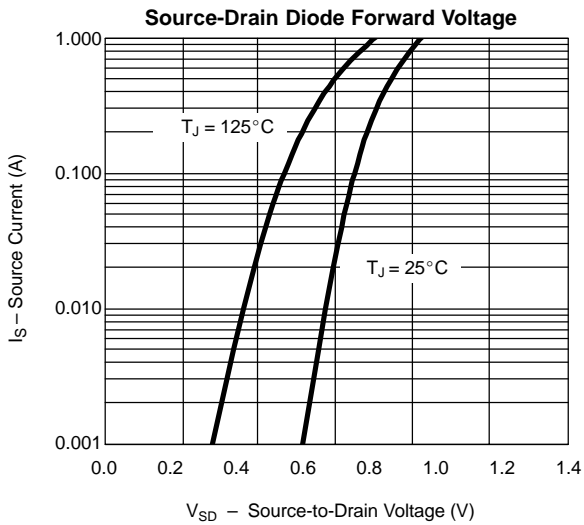



Notice

Specifications of the products displayed herein are subject to change without notice. Vishay Intertechnology, Inc., or anyone on its behalf, assumes no responsibility or liability for any errors or inaccuracies.

Information contained herein is intended to provide a product description only. No license, express or implied, by estoppel or otherwise, to any intellectual property rights is granted by this document. Except as provided in Vishay's terms and conditions of sale for such products, Vishay assumes no liability whatsoever, and disclaims any express or implied warranty, relating to sale and/or use of Vishay products including liability or warranties relating to fitness for a particular purpose, merchantability, or infringement of any patent, copyright, or other intellectual property right.

The products shown herein are not designed for use in medical, life-saving, or life-sustaining applications. Customers using or selling these products for use in such applications do so at their own risk and agree to fully indemnify Vishay for any damages resulting from such improper use or sale.