

### DESCRIPTION

M54585P and M54585FP are eight-circuit Darlington transistor arrays with clamping diodes. The circuits are made of NPN transistors. Both the semiconductor integrated circuits perform high-current driving with extremely low input-current supply.

### FEATURES

- High breakdown voltage ( $BV_{CEO} \geq 50V$ )
- High-current driving ( $I_c(\max) = 500mA$ )
- With clamping diodes
- Driving available with TTL output or with PMOS IC output
- Wide operating temperature range ( $T_a = -20$  to  $+75^\circ C$ )

### APPLICATION

Drives of relays and printers, digit drives of indication elements such as LEDs and lamps, and MOS-bipolar logic IC interfaces

### FUNCTION

The M54585P and M54585FP each have eight circuits, which are NPN Darlington transistors. Input transistors have resistance of  $2.7k\Omega$  between the base and input pin. A spike-killer clamping diode is provided between each output pin and GND. Output transistor emitters are all connected to the GND pin.

Collector current is 500mA maximum. The maximum collector-emitter voltage is 50V.

The M54585FP is enclosed in a molded small flat package, enabling space-saving design.

### PIN CONFIGURATION

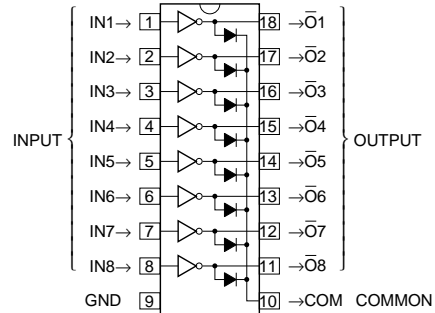

Package type 18P4G(P)

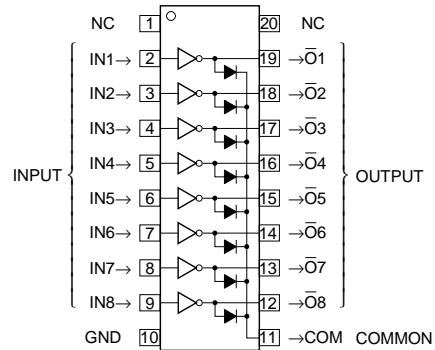

Package type 20P2N-A(FP)

NC : No connection

### CIRCUIT DIAGRAM

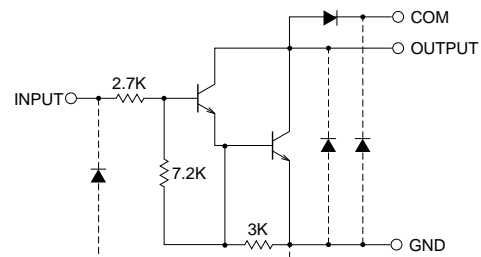

The eight circuits share the COM and GND.

The diode, indicated with the dotted line, is parasitic, and cannot be used.

Unit :  $\Omega$

## 8-UNIT 500mA DARLINGTON TRANSISTOR ARRAY WITH CLAMP DIODE

**ABSOLUTE MAXIMUM RATINGS** (Unless otherwise noted, Ta = -20 ~ +75°C)

Symbol	Parameter	Conditions	Ratings	Unit
V <sub>CEO</sub>	Collector-emitter voltage	Output, H	-0.5 ~ +50	V
I <sub>C</sub>	Collector current	Current per circuit output, L	500	mA
V <sub>I</sub>	Input voltage		-0.5 ~ +30	V
I <sub>F</sub>	Clamping diode forward current		500	mA
V <sub>R</sub>	Clamping diode reverse voltage		50	V
P <sub>d</sub>	Power dissipation	Ta = 25°C, when mounted on board	1.79(P)/1.10(FP)	W
T <sub>opr</sub>	Operating temperature		-20 ~ +75	°C
T <sub>stg</sub>	Storage temperature		-55 ~ +125	°C

**RECOMMENDED OPERATING CONDITIONS** (Unless otherwise noted, Ta = -20 ~ +75°C)

Symbol	Parameter	Limits			Unit	
		min	typ	max		
V <sub>O</sub>	Output voltage	0	—	50	V	
I <sub>C</sub>	Collector current (Current per 1 circuit when 8 circuits are coming on simultaneously)	Duty Cycle P : no more than 6% FP : no more than 4%	0	—	400	mA
		Duty Cycle P : no more than 34% FP : no more than 20%	0	—	200	
V <sub>IH</sub>	"H" input voltage	I <sub>C</sub> ≤ 400mA	3.85	—	30	V
		I <sub>C</sub> ≤ 200mA	3.4	—		
V <sub>IL</sub>	"L" input voltage		0	—	0.6	V

**ELECTRICAL CHARACTERISTICS** (Unless otherwise noted, Ta = -20 ~ +75°C)

Symbol	Parameter	Test conditions	Limits			Unit
			min	typ*	max	
V (BR) CEO	Collector-emitter breakdown voltage	I <sub>CEO</sub> = 100μA	50	—	—	V
V <sub>CE (sat)</sub>	Collector-emitter saturation voltage	V <sub>I</sub> = 3.85V, I <sub>C</sub> = 400mA	—	1.3	2.4	V
		V <sub>I</sub> = 3.4V, I <sub>C</sub> = 200mA	—	1.0	1.6	
I <sub>I</sub>	Input current	V <sub>I</sub> = 3.85V	—	0.95	1.8	mA
		V <sub>I</sub> = 25V	—	8.7	18	
V <sub>F</sub>	Clamping diode forward voltage	I <sub>F</sub> = 400mA	—	1.5	2.4	V
I <sub>R</sub>	Clamping diode reverse current	V <sub>R</sub> = 50V	—	—	100	μA
h <sub>FE</sub>	DC amplification factor	V <sub>CE</sub> = 4V, I <sub>C</sub> = 350mA, Ta = 25°C	1000	2500	—	—

\* : The typical values are those measured under ambient temperature (Ta) of 25°C. There is no guarantee that these values are obtained under any conditions.

**SWITCHING CHARACTERISTICS** (Unless otherwise noted, Ta = 25°C)

Symbol	Parameter	Test conditions	Limits			Unit
			min	typ	max	
t <sub>on</sub>	Turn-on time	C <sub>L</sub> = 15pF (note 1)	—	12	—	ns
t <sub>off</sub>	Turn-off time		—	240	—	ns

### 8-UNIT 500mA DARLINGTON TRANSISTOR ARRAY WITH CLAMP DIODE

#### NOTE 1 TEST CIRCUIT

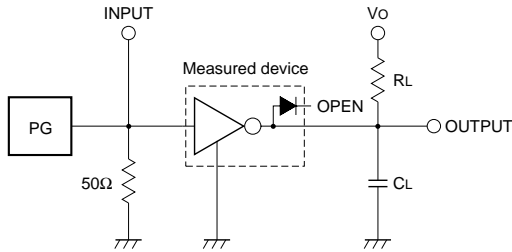

- (1) Pulse generator (PG) characteristics : PRR = 1kHz,  
 $t_w = 10\mu s$ ,  $t_r = 6ns$ ,  $t_f = 6ns$ ,  $Z_O = 50\Omega$   
 $V_i = 3.85V$
- (2) Input-output conditions :  $R_L = 25\Omega$ ,  $V_o = 10V$
- (3) Electrostatic capacity  $C_L$  includes floating capacitance at connections and input capacitance at probes

#### TIMING DIAGRAM

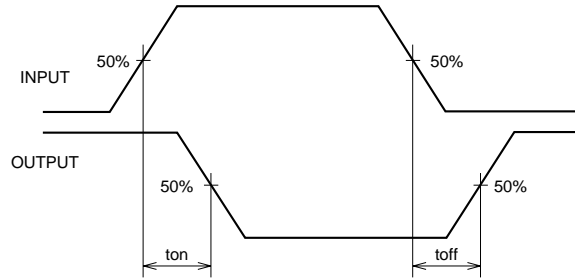

#### TYPICAL CHARACTERISTICS

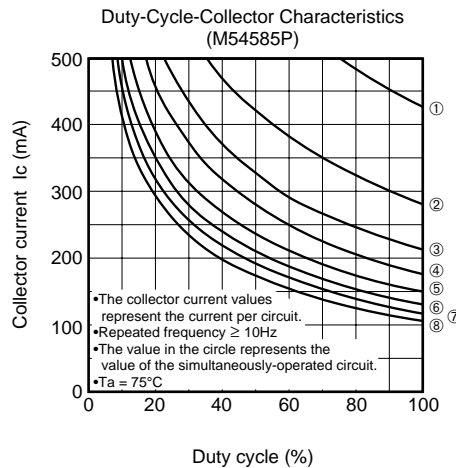
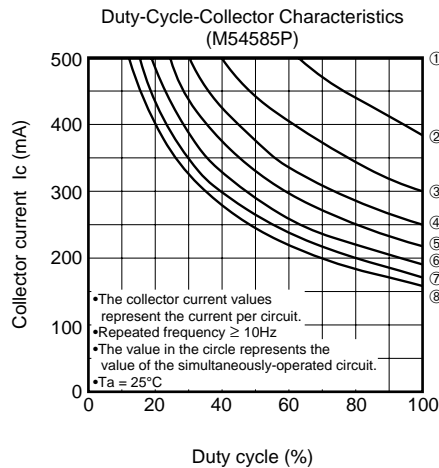
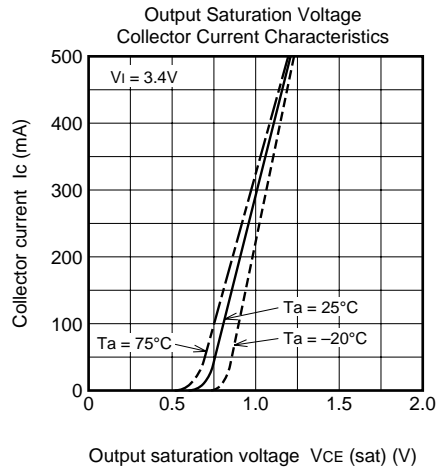
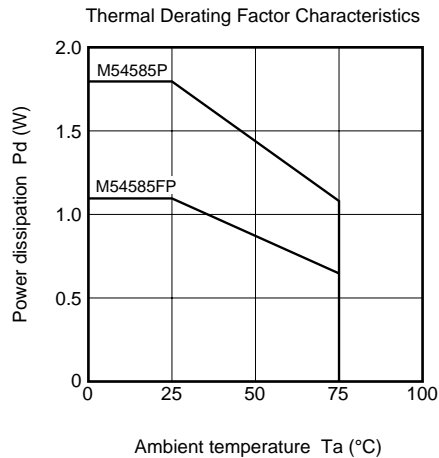

8-UNIT 500mA DARLINGTON TRANSISTOR ARRAY WITH CLAMP DIODE

Duty-Cycle-Collector Characteristics  
(M54585FP)

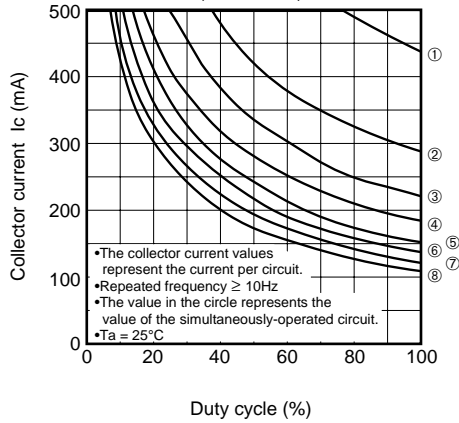

Duty-Cycle-Collector Characteristics  
(M54585FP)

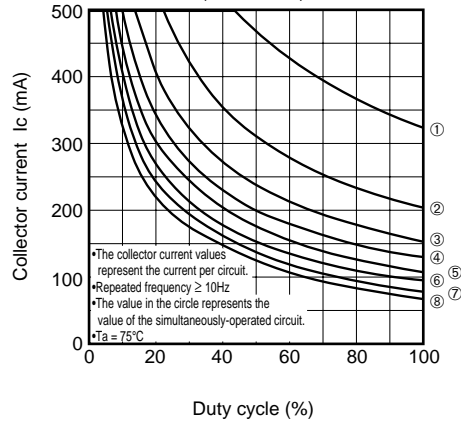

DC Amplification Factor  
Collector Current Characteristics

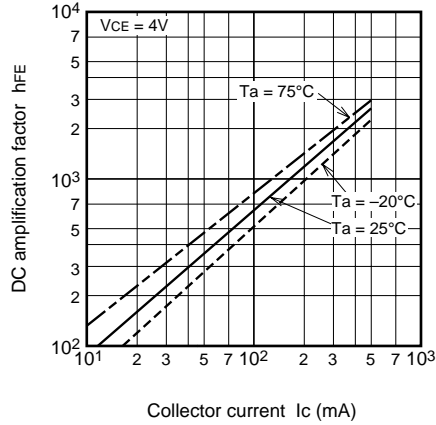

Grounded Emitter Transfer Characteristics

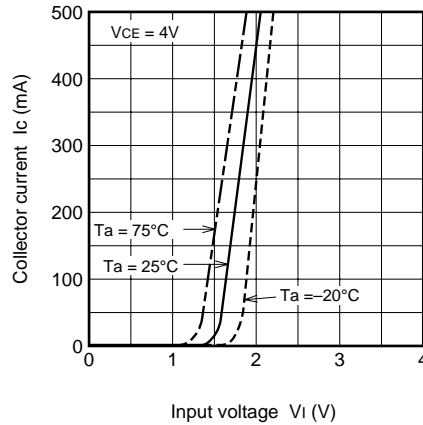

Input Characteristics

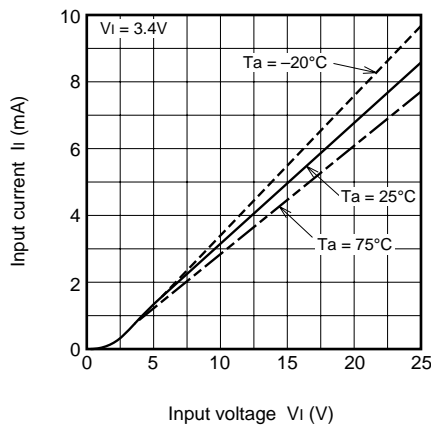

Clamping Diode Characteristics

