

Tantalum Capacitor (SCN Series)



The product is a standard type that has been most widely used among tantalum chip capacitors.

The SCN series have fully molded, compliant lead frame construction designed for use in applications utilizing solder (Reflow, Wave or Vapor Phase), conductive adhesive or thermal compression bonding techniques.

General Features

- Molded Case available in four case codes.
- Compatible with automatic pick and place equipment.
- Meets or Exceeds EIA standard 535BAAC .

Applications

Tantalum capacitor are designed with excellent performance characteristics for filtering, by- passing, coupling, blocking and R,C tuning circuits.

They are used extensively in industrial, commercial, entertainment and medical electronic equipment.

- General electronic equipment
- Smoothing Circuit of DC-DC Converters & Output side of AC-DC Converters
- De-Coupling Circuit of High Speed ICs & MPUs
- Various Other High Frequency Circuit Applications

Part Numbering

| | | | | | | | |
|-----------|------------|-----------|------------|----------|----------|----------|----------|
| <u>TC</u> | <u>SCN</u> | <u>0J</u> | <u>106</u> | <u>M</u> | <u>B</u> | <u>A</u> | <u>R</u> |
| ① | ② | ③ | ④ | ⑤ | ⑥ | ⑦ | ⑧ |

- | | |
|--------------------------------------|-------------------------|
| ① Abbreviation of Tantalum Capacitor | ⑤ Capacitance Tolerance |
| ② Type of Series | ⑥ Case size |
| ③ Rated Voltage | ⑦ Packing |
| ④ Capacitance Tolerance | ⑧ Packing Polarity |

❶ ABBREVIATION OF TANTALUM CAPACITOR

❷ TYPE OF SERIES

The symbol shows the type of the capacitor. (SCN, SCS)

- SCN : Samsung Capacitor Normal - Standard series

❸ RATED VOLTAGE

| Symbol | DC Rated Voltage | Symbol | DC Rated Voltage |
|--------|------------------|--------|------------------|
| 0E | 2.5 | 1C | 16 |
| 0G | 4 | 1D | 20 |
| 0J | 6.3 | 1E | 25 |
| 1A | 10 | 1V | 35 |

❹ CAPACITANCE

| Symbol | Capacitance (μF) | Pico Farad (pF) | Symbol | Capacitance (μF) | PicoFarad (pF) |
|--------|-------------------------------|----------------------------|--------|-------------------------------|---------------------------|
| 105 | 1.0 | 10×10^5 | 685 | 6.8 | 68×10^5 |
| 106 | 10.0 | 10×10^6 | 476 | 47 | 47×10^6 |
| 107 | 100.0 | 10×10^7 | 477 | 470 | 47×10^7 |

❺ CAPACITANCE TOLERANCE

| Symbol | Tolerance(%) | Symbol | Tolerance(%) |
|--------|--------------|--------|--------------|
| K | ± 10 | M | ± 20 |

❻ CASE SIZE

| Case | EIA Code | Case | EIA Code |
|------|----------|------|----------|
| A | 3216 | C | 6032 |
| B | 3528 | D | 7343 |

7 PACKING

| Symbol | Packing Code |
|--------|--------------|
| A | 7 inch |
| C | 13 inch |

8 PACKING POLARITY

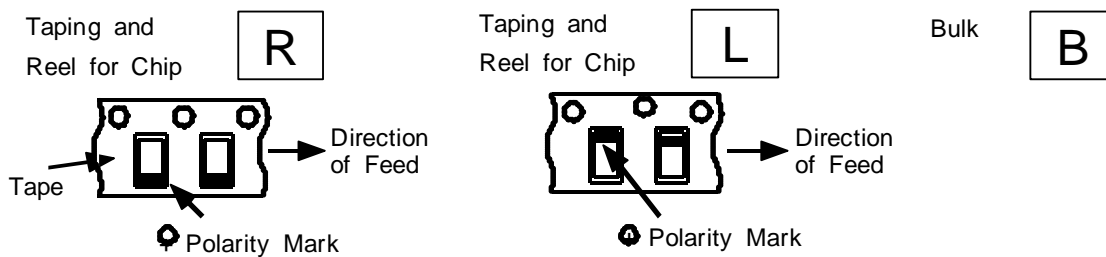

APPEARANCE AND DIMENSION

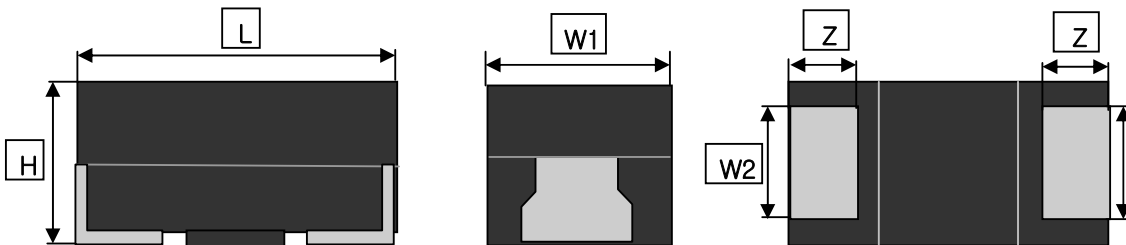

| Code | EIA Code | DIMENSION (mm) | | | | |
|------|----------|----------------|---------------|---------------|---------------|---------------|
| | | L | W_1 | W_2 | H | Z |
| A | 3216 | 3.2 ± 0.2 | 1.6 ± 0.2 | 1.2 ± 0.1 | 1.6 ± 0.2 | 0.8 ± 0.3 |
| B | 3528 | 3.5 ± 0.2 | 2.8 ± 0.2 | 2.2 ± 0.1 | 1.9 ± 0.2 | 0.8 ± 0.3 |
| C | 6032 | 6.0 ± 0.3 | 3.2 ± 0.3 | 2.2 ± 0.1 | 2.5 ± 0.3 | 1.3 ± 0.3 |
| D | 7343 | 7.3 ± 0.3 | 4.3 ± 0.3 | 2.4 ± 0.1 | 2.8 ± 0.3 | 1.3 ± 0.3 |

● **Standard value and Case size**

Standard value and case size

| Cap.(μ F) | R . V | 4V(0G) | 6.3V(0J) | 10V(1A) | 16V(1C) | 20V(1D) | 25V(1E) | 35V(1V) |
|----------------|-------|--------|----------|---------|---------|---------|---------|---------|
| 0.15 | 154 | | | | | | | A |
| 0.22 | 224 | | | | | | | A |
| 0.33 | 334 | | | | | | A | A |
| 0.47 | 474 | | | | | A | A | B |
| 0.68 | 684 | | | | A | A | | |
| 1.0 | 105 | | | A | A | | | B |
| 1.5 | 155 | | A | A | | | B | |
| 2.2 | 225 | A | A | | | B | | C |
| 3.3 | 335 | A | | | B | C | C | C |
| 4.7 | 475 | | | B | C | C | C | D |
| 6.8 | 685 | | B | C | C | C | D | D |
| 10 | 106 | B | C | C | C | D | D | |
| 15 | 156 | C | C | C | D | D | | |
| 22 | 226 | C | C | D | D | | | |
| 33 | 336 | C | D | D | | | | |
| 47 | 476 | D | D | | | | | |
| 68 | 686 | D | | | | | | |

RELIABILITY TEST CONDITION

Reliability Test and Judgment Condition 1

| Item | Performance | Test condition |
|-------------------------------------|--|---|
| Capacitance | Within specified tolerance | 120Hz, maximum 1.0Vrms, maximum 1.5Volt D.C, at 25 °C |
| Tan δ (DF) | Within specified value | 120Hz, maximum 1.0Vrms, maximum 1.5Volt D.C, at 25 °C |
| Impedance (Z) & ESR | Within specified value | 100kHz, maximum 1.0Vrms, maximum 1.5Volt D.C, at 25 °C |
| Leakage current | 0.01CV or 0.5 μ A whichever is greater | The rated DC voltage shall be applied to terminals across the test capacitor charge Time: 5 min. |
| Temperature Characteristics | "-55 °C : Δ C/C -10~0% "+85 °C : Δ C/C 0~10% "+125 °C : Δ C/C 0~15% | From -55 °C to 125 °C, |
| Surge withstanding Voltage | Capacitance change : within \pm 5 % Tan δ , LC : initial spec. | 85 \pm 2 °C, Surge voltage Charge 30 \pm 5s -> Discharge 5.5 \pm 0.5min 1000cycle Charge discharge resistor :33 Ω |
| Adhesion Strength | No peeling shall be occur on the terminal electrode | 19.6N, for 5 \pm 1 sec |
| Electrode Strength | Within specified tolerance Tan δ , LC : initial spec. | Bending to the limit (3mm) with 1.0mm/sec. |
| Solderability | More than 95% of terminal surface is to be soldered newly | SnAg3.0Cu0.5 solder :245 \pm 5 °C, 3 \pm 0.3sec (preheating : 80~120 °C for 10~30sec.) |
| Resistance to Soldering heat | Capacitance change : within \pm 15% Tan δ , LC : initial spec. | Solder pot : 260 \pm 5 °C, 10 \pm 1 sec. |
| Vibration Test | Capacitance change : within \pm 5% Tan δ , LC : initial spec. | Amplitude : 1.5mm From 10Hz to 55Hz (return : 1min.) 2hours ´ 3 direction (x, y, z) |
| Moisture Resistance | Capacitance change : within \pm 10% Tan δ , LC : initial spec. | 40 \pm 2 °C, 90~95%RH, 500+8/-0hrs |
| High Temperature Resistance | Capacitance change : within \pm 10% Tan δ :initial spec LC : 125% or less specified initial value | With the rated voltage(85 °C) Max. operating temperature(125 °C) 2000/-0hrs |
| Storage at Low Temperature | Capacitance change : within \pm 10% Tan δ , LC : initial spec. | -55 \pm 2 °C, 240 \pm 8hrs |
| Temperature Cycling | Capacitance change : within \pm 5% Tan δ , LC : initial spec | 1 cycle condition (Min. operating temperature \rightarrow 25 °C \rightarrow Max. operating temperature \rightarrow 25 °C) 5 cycle test |

RELIABILITY TEST CONDITION

Table 1 : Maximum Dissipation Factor at Specified Temperatures

| Maximum Dissipation Factor, % | | | |
|-------------------------------|------------|------------|-------------|
| -55 °C (%) | +25 °C (%) | +85 °C (%) | +125 °C (%) |
| 9 | 4 | 7 | 9 |
| 10 | 6 | 8 | 10 |
| 12 | 8 | 10 | 12 |
| 15 | 10 | 13 | 15 |
| 17 | 12 | 15 | 17 |
| 27 | 18 | 27 | 36 |
| 30 | 20 | 30 | 40 |
| 45 | 30 | 45 | 60 |

Table 2 : Maximum DC Leakage Current at Specified Temperatures

| Maximum DC Leakage Current, μA | | | |
|---|--------------------------|--|---|
| Specified initial value | -55 °C (μA) | +85 °C (μA) | +125 °C (μA) |
| 0.01CV or 0.5 μA whichever is greater | - | 0.1CV or 5 μA whichever is greater | 0.125CV or 6.25 μA whichever is greater |

PACKAGING

● MARKING

▶ A,S CASES

[SCN,SCS,SCE series]



[SCL, series]

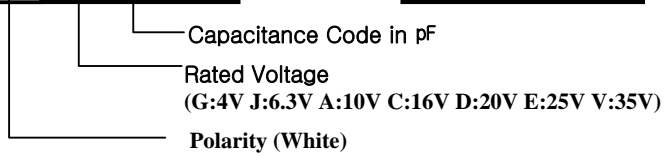

▶ B,T CASES

[SCN,SCS,SCE series]

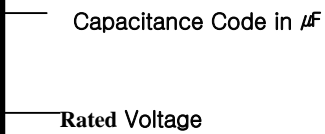
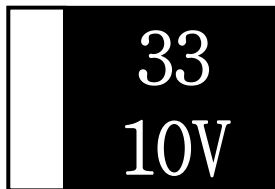

Polarity (White)

[SCL series]

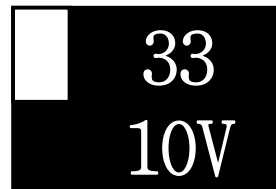

▶ C,D CASES

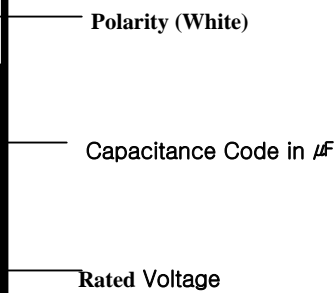
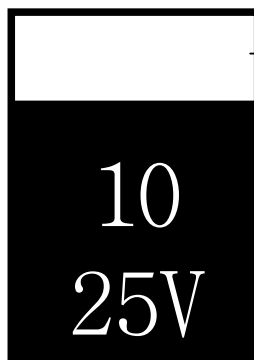

● EMBOSSED PLASTIC TAPE

The tantalum chip capacitors shall be packaged in tape and reel form for effective use.

- Tape : Semitransparent embossed plastic
- Cover tape : Attached with press, polyester
- The tension of removing the cover tape, $F=10 \sim 70g$

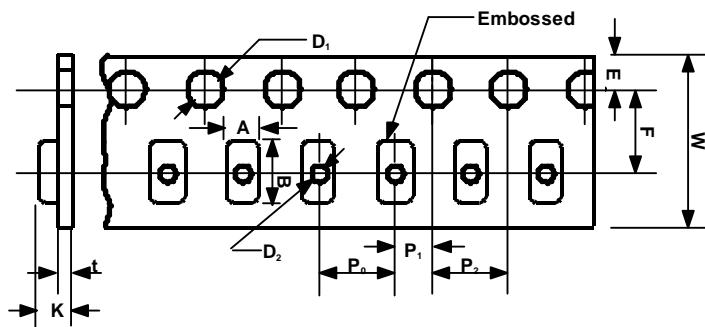
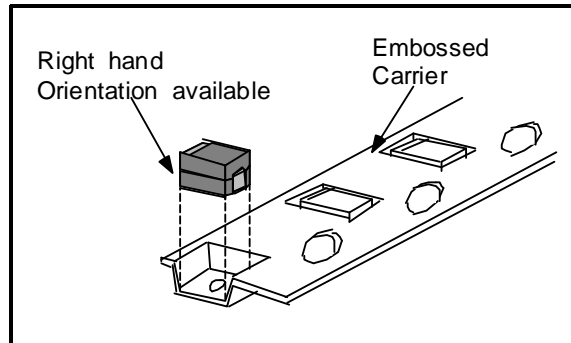

| Case Code | W ± 0.3 (± 0.002) | F ± 0.1 (± 0.004) | E ± 0.1 (± 0.004) | P ± 0.1 (± 0.004) | P ± 0.1 (± 0.004) | P ± 0.1 (± 0.004) | D ± 0.1 (± 0.004) | D Min. | t | A ± 0.2 (± 0.008) | B ± 0.2 (± 0.008) | K ± 0.2 (± 0.008) |
|-----------|--------------------------------|--------------------------------|--------------------------------|--------------------------------|--------------------------------|--------------------------------|--------------------------------|-----------------------|------------------|--------------------------------|--------------------------------|--------------------------------|
| Q | | | | | | | | $\phi 0.6$ (0.024) | 0.25 (0.0098) | 0.98 (0.039) | 1.80 (0.071) | 0.82 (0.032) |
| J,K | | | | | | | | | | | | 1.0 (0.039) |
| R | | | | | | | | | | 1.4 (0.055) | 2.3 (0.091) | 1.1 (0.043) |
| P | 8 (0.315) | 3.5 (0.138) | | 4 (0.157) | | | | | 0.2 (0.008) | | | 1.4 (0.055) |
| S | | | 1.75 (0.069) | | 2 (0.079) | 4 (0.157) | $\phi 1.5$ (0.059) | $\phi 1.0$ (0.039) | | 1.9 (0.075) | 3.5 (0.138) | 1.3 (0.051) |
| A | | | | | | | | | | | | 1.9 (0.075) |
| T | | | | | | | | | | | | 1.3 (0.051) |
| B | | | | | | | | | 0.3 (0.012) | 3.3 (0.130) | 3.8 (0.150) | 2.1 (0.083) |
| C | 12 (0.472) | 5.5 (0.217) | | 8 (0.315) | | | | $\phi 1.5$ (0.059) | | 3.7 (0.146) | 6.4 (0.252) | 3.0 (0.118) |
| D | | | | | | | | | | 4.8 (0.189) | 7.7 (0.303) | 3.3 (0.130) |

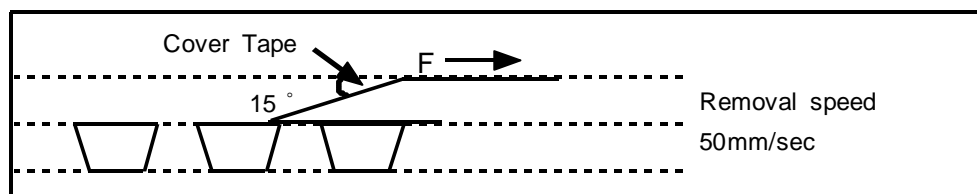

● REEL DIMENSION

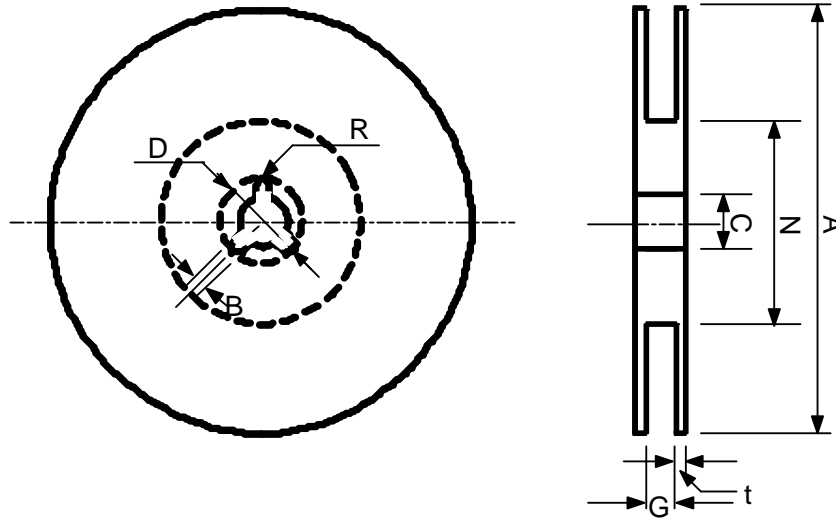

| Tape Width | A±2 (±0.079) | N Min. | C±0.5 (±0.020) | D±0.5 (±0.020) | B±0.51 (±0.020) | | t±0.5 (±0.020) | R |
|------------|-----------------|-----------------|-------------------|-------------------|--------------------|---------------|-------------------|-----------------|
| 8mm | ø 178 (7) | ø 50 (1.969) | ø 13 (0.512) | ø 21 (0.827) | 2 (0.079) | 10 (0.394) | 2 (0.079) | 0.99 (0.039) |
| 12mm | | | | | | 14 (0.551) | | |
| 8mm | ø 330 (13) | ø 80 (3.150) | ø 13 (0.512) | ø 21 (0.827) | 2 (0.079) | 10 (0.394) | 2 (0.079) | 0.99 (0.039) |
| 12mm | | | | | | 14 (0.551) | | |

| Case Size reference | 180mm(7") reel | 330mm(13") reel |
|---------------------|----------------|-----------------|
| J(Q),K | 4,000pcs | - |
| P(R) | 3,000pcs | - |
| A(S) , B(T) | 2,000pcs | 8,000pcs |
| C , D | 500pcs | 2,500pcs |

APPLICATION MANUAL

The operational attentions to the use of the tantalum capacitors are as follows:

- Electrical
- Environmental
- Conditions for mounting on equipment and circuit boards
- Mechanical vibration, shock

If the tantalum capacitors are used without satisfying any one of these conditions, the probability of short-circuiting, leakage current, ignition or other problems to occur increases. To avoid such problems, observe the following precautions when using the tantalum capacitors.

● OPERATING VOLTAGE

- ▶ The voltage derating factor should be as great as possible. Under normal conditions, the operating voltage should be reduced to 50% or less of the rating. It is recommended that the operating voltage be 30% or less of the rating, particularly when the tantalum capacitors are used in a low-impedance circuit (see Figs. 1, 2, and 3).
- ▶ For circuits in which a switching, charging, discharging, or other momentary current flows, it is recommended that the operating voltage be 30% or less of the rating, with a resistor connected in series to limit the current to 300 mA or less.
- ▶ When the tantalum capacitors are to be used at an ambient temperature of higher than 85°C, the recommended operating range shown in Fig. 3 should not be exceeded.

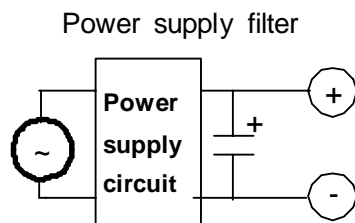

Fig. 1

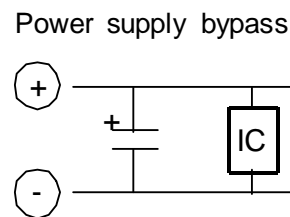

Fig. 2

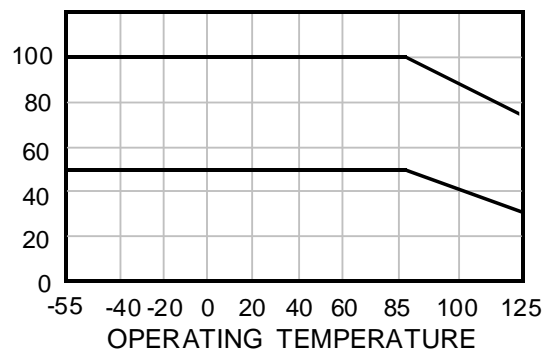

Fig. 3

● RIPPLE

The maximum permissible ripple voltage and current are related to the ratings case size.

Please consult us detail in formations.

► Ripple Current

The maximum permissible ripple current, I_{MAX} , is calculated as follows :

$$I_{MAX} = \sqrt{\frac{P_{MAX}}{ESR(f)}}$$

where:

I_{MAX} : Maximum permissible capacitor ripple current (Arms).

P_{MAX} : Maximum permissible capacitor power loss (W).

Varies with the ambient temperature and case size.

Calculated according to Table

$ESR(f)$: Capacitor equivalent series resistance (Ω).

Since the $ESR(f)$ value varies with the ripple frequency, however, the following correction must be made in accordance with the operating frequency (see Fig. 4).

$$ESR(f) = K \cdot ESR(120)$$

K : Coefficient for the operating frequency (Fig. 4).

$$ESR(120) = \tan \delta \cdot X_c = \frac{\tan \delta}{2\pi f C}$$

where:

$ESR(120)$: Equivalent series resistance at 120 Hz (Ω).

X_c : Capacitive reactance at 120 Hz (Ω).

C : Electrostatic capacitance at 120 Hz (μF).

f : Operating frequency (Hz).

Table.1 Maximum permissible power loss values (P_{MAX}) by case size

| Ambient temperature ($^{\circ}C$) | $P_{MAX}(W)$ | | | | | |
|-------------------------------------|--------------|-------|-------|-------|-------|-------|
| | J | P | A | B | C | D |
| 25 | 0.015 | 0.015 | 0.030 | 0.030 | 0.030 | 0.050 |
| 55 | 0.010 | 0.010 | 0.019 | 0.019 | 0.019 | 0.032 |
| 85 | 0.005 | 0.005 | 0.010 | 0.010 | 0.010 | 0.018 |

Table.2 Hz VS K

| Frequency | K |
|-----------|------|
| 120 | 1.0 |
| 400 | 0.8 |
| 1k | 0.65 |
| 10k | 0.50 |
| 20k | 0.45 |
| 40k | 0.43 |
| 100k | 0.40 |
| 1M | 0.35 |

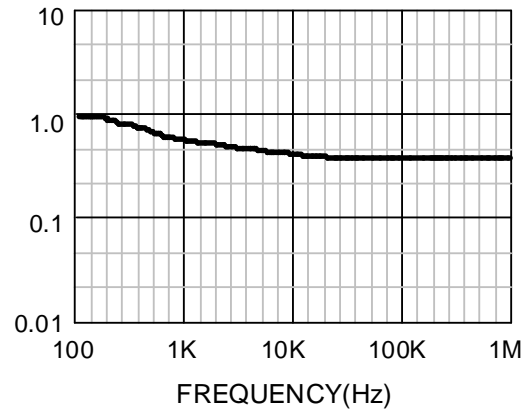
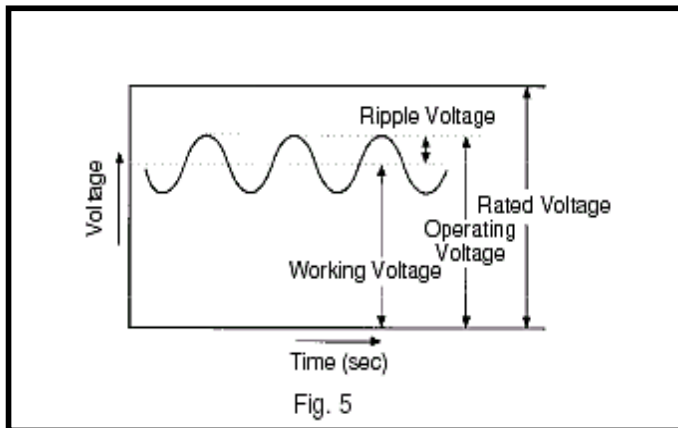

Fig.4 Correction Coefficient(K)

► Ripple Voltage

If an excessive ripple voltage is applied to the tantalum capacitors, their internal temperature rises due to Joule heat, resulting in the detriment of their reliability.



- ▷ The tantalum capacitors must be used in such a conditions that the sum of the Working Voltage and ripple voltage peak values does not exceed the rated voltage (Fig. 5)
- ▷ Ensure that an reverse voltage due to superimposed voltages is not applied to the capacitors.
- ▷ The maximum permissible ripple voltage varies with the rated voltage. Ensure that ripple voltage does not exceed the values shown in Figs 6 and 7. If, however, the capacitors are used at a high temperature, the maximum permissible ripple voltage must be calculated as follows:

$$V_{rms}(at\ 55^{\circ}C) = 0.7 \times V_{rms}(at\ 25^{\circ}C)$$

$$V_{rms}(at\ 85^{\circ}C) = 0.5 \times V_{rms}(at\ 25^{\circ}C)$$

$$V_{rms}(at\ 125^{\circ}C) = 0.3 \times V_{rms}(at\ 25^{\circ}C)$$

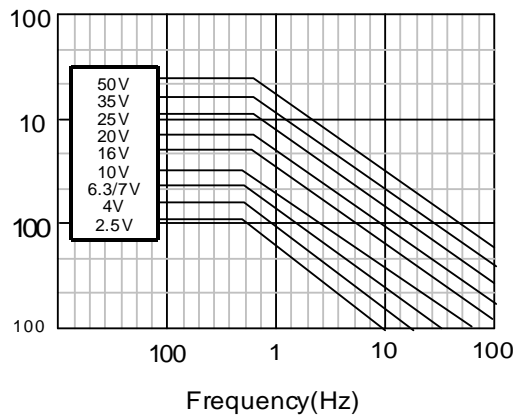

Fig.6 Maximum permissible ripple voltage (P,A,B)

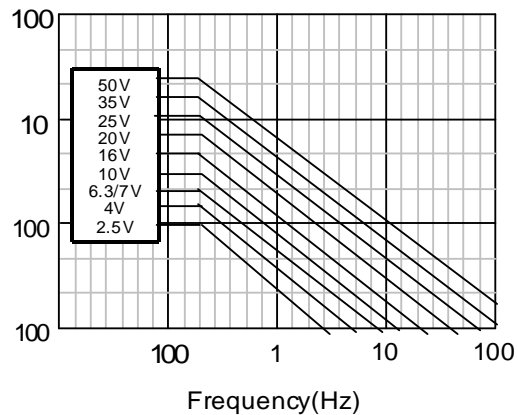

Fig.7 Maximum permissible ripple voltage (C,D)

● REVERSE VOLTAGE

Solid tantalum capacitors are polarized device and may be permanently damaged or destroyed, if connected with the wrong polarity.

- ▷ The tantalum capacitors must not be operated and changed in reverse mode. And also the capacitors must not be used in an only AC circuit.
- ▷ The tantalum capacitor dielectric has a rectifying characteristics. Therefore, when a reverse voltage is applied to it, a large current flows even at a low reverse voltage. As a result, it may spontaneously generate heat and lead to shorting.
- ▷ Make sure that the polarity and voltage is correct when applying a multi-meter or similar testing instrument to the capacitors because a reverse voltage or overvoltage can be accidentally applied.
- ▷ When using the capacitors in a circuit in which a reverse voltage is applied, consult your local SAMSUNG ELECTRO-MECHANICS agent. If the application of an reverse voltage is unavoidable, it must not exceed the following values.

At 20°C: 10% of the rated voltage of 1 V, whichever smaller.

At 85°C: 5% of the rated voltage or 0.5 V, whichever smaller.

● RELIABILITY OF TANTALUM CAPACITORS

► General

The failure rate of the tantalum capacitor varies with the digression ratio, ambient temperature, circuit resistance, circuit application, etc.

Therefore, when proper selections are made so as to afford additional margins, higher reliability can be derived from the tantalum capacitors. Some examples of actual failure rates are presented below for your reference.

► Failure Rate Calculation Formula

The tantalum capacitors are designed to work at their basic failure rates shown in Table 3 that prevail when the rated voltage is applied for 1000 hours at 85°C.

Table 3 Basic failure rate

| TYPE | Classification | Basic failure rate |
|------|----------------------------|--------------------|
| SCF | Face-down type | 1%/1000h |
| SCE | Low ESR type | |
| SCM | Ultra-Miniature type(0603) | |
| SCL | Low profile type | |
| SCS | Small type | |
| SCN | Standard type | |

▷ Failure rate calculation formula

$$\lambda_{use} = \lambda_{85} \times K_V \times K_R$$

λ_{use} : Estimated capacitor failure rate under the operating conditions.

λ_{85} : Basic failure rate (Table 3)

K_V : Failure rate correction coefficient by the ambient temperature and derating factor.

K_R : Failure rate correction coefficient by the circuit resistance,

which is the series-connected resistance divided by the voltage applied to the capacitor.

This resistance is connected in series when the power supply side is viewed from the capacitor side.

$K_{(derating\ factor)} = \text{operating voltage} / \text{rated voltage}$

● RELIABILITY PREDICTION

Solid tantalum capacitors exhibit no degradation failure mode during shelf storage and show a constantly decreasing failure rate (i.e., absence of wearout mechanism) during life tests. This failure rate is dependent upon three important application conditions: DC voltage, temperature, and circuit impedance.

Estimates of these respective effects are provided by the reliability nomograph. (Figure 8.)

The nomograph relates failure rate to voltage and temperature while the table relates failure rate to impedance. These estimates apply to steady-state DC condition, and they assume usage within all other rated conditions.

Standard conditions, which produce a unity failure rate factor, are rated voltage, +85°C, and 0.1 ohm-per-volt impedance.

While voltage and temperature are straight-forward, there is sometimes difficulty in determining impedance. What is required is the circuit impedance seen by the capacitor. If several capacitors are connected in parallel, the impedance seen by each is lowered by the source of energy stored in the other capacitors. Energy is similarly stored in series inductors.

Voltage "de-rating" is a common and useful approach to improved reliability. It can be pursued too far, however, when it leads to installation of higher voltage capacitors of much larger size.

It is possible to lose more via higher inherent failure rate than is gained by voltage derating. SAMSUNG typically recommends 50% derating, especially in low impedance circuits.

Failure rate is conventionally expressed in units of percent per thousand hours. As a sample calculation, suppose a particular batch of capacitors has a failure rate of 0.5% / Khr under standard conditions.

What would be the predicted failure rate at 0.7 times rated voltage, 60°C and 0.6Ω/V?

The nomograph gives a factor of 7×10^{-2} and the table gives a factor of 0.4.

The failure rate estimate is then :

$$0.5 \times 7 \times 10^{-2} \times 0.4 \\ = 1.4 \times 10^{-2} \text{ or } 0.014\%/\text{Khr}$$

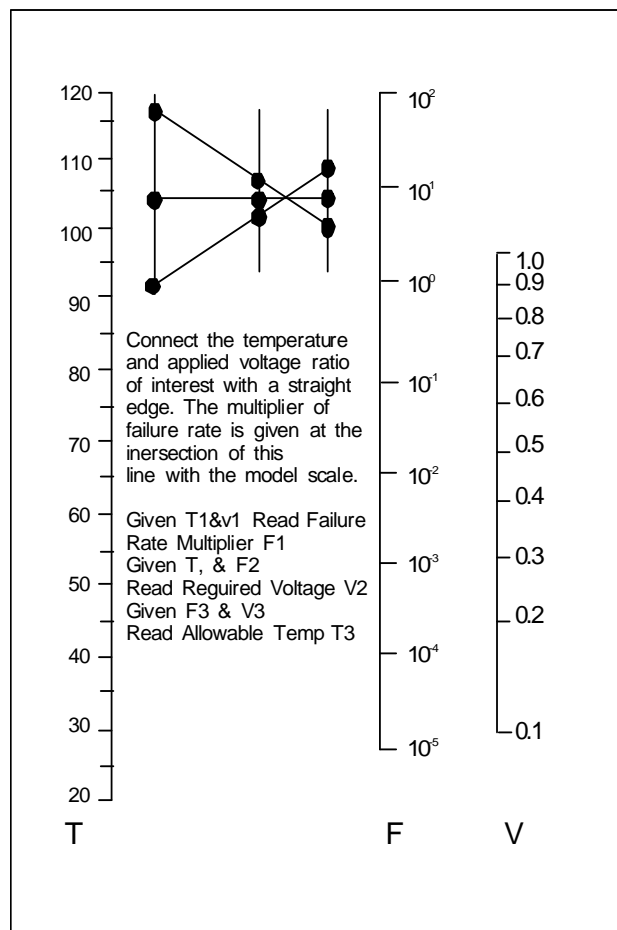

Fig.8 Reliability Nomograph

Table 4 Circuit Impedance Reliability Factors

| Circuit Impedance (ohms/volt) | Failure Rate Impedance (multiplying factor) |
|----------------------------------|--|
| 0.1 | 1.0 |
| 0.2 | 0.8 |
| 0.4 | 0.6 |
| 0.6 | 0.4 |
| 0.8 | 0.3 |
| 1.0 | 0.2 |
| 2.0 | 0.1 |
| 3 or greater | 0.07 |

● MOUNTING PRECAUTIONS

▶ Limit Pressure on Capacitor Installation with Moulder

A capacitor that has been damaged should be discarded to avoid later problems resulting from mechanical stress.

Pressure must not exceed 4.9 N with a tool end diameter of 1.5mm when applied to the capacitors using an absorber, centering tweezers, or the like. An excessively low absorber setting position would result in not only the application of undue force to the capacitors but capacitor and other component scattering, circuit board wiring breakage, and / or cracking as well, particularly when the capacitors are mounted together with other chips having a height of 1 mm or less.

▶ Flux

- ▷ Select a flux that contains a minimum of chlorine and amine.
- ▷ After flux use, the chlorine and amine in the flux remain and must therefore be removed.

▶ Recommended Soldering Pattern Dimensions

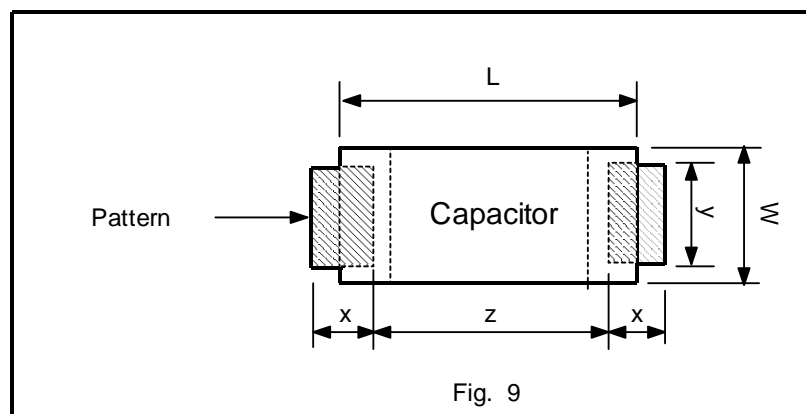

Table 4 Recommended soldering pattern dimensions(mm)

| Dimensions Case | Capacitors size | | Pattern dimensions | | |
|--------------------|-----------------|------|--------------------|-----|-----|
| | L | W | x | y | z |
| J,Q,K | 1.6 | 0.85 | 0.9 | 1.0 | 0.7 |
| P,R | 2.0 | 1.25 | 1.2 | 1.1 | 0.8 |
| A,S | 3.2 | 1.6 | 1.6 | 1.2 | 1.2 |
| B,T | 3.5 | 2.8 | 1.6 | 2.2 | 1.4 |
| C,V | 5.8 | 3.2 | 2.3 | 2.4 | 2.4 |
| D,W | 7.3 | 4.3 | 2.3 | 2.6 | 3.8 |

► **Chip Soldering Temperature and Time**

Capacitors are capable of withstanding the following soldering temperatures and conditions;

- ▷ Waved soldering

Capacitor body temperature : 230°C ~ 260°C

Time : 5 seconds or less

- ▷ Reflow soldering see figures

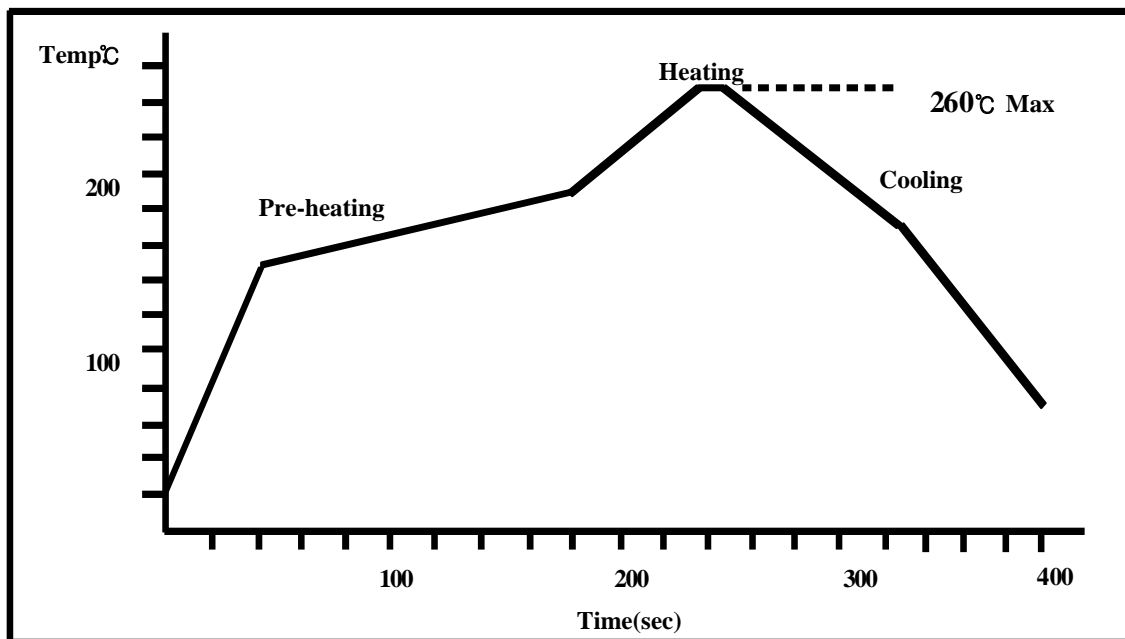

※ Recommend Temperature : 235°C ~ 245°C

(With Pb-free products, if used under 235°C, the quality confirmation must be needed.)

▷ Soldering with a soldering iron

The use of a soldering iron should be avoided wherever possible. If it is unavoidable, follow the instructions set forth in Table 5. The time of soldering with an iron should be one.

Table 5

| | |
|--------------------------------|-----------------------|
| Type | All case |
| Soldering-iron tip temperature | 350 °C _{MAX} |
| Time | 3 sec _{MAX} |
| Soldering-iron power | 30 W _{MAX} |

▶ **Cleaning after Mounting**

The following solvents are usable when cleaning the capacitors after mounting. Never use a highly active solvent.

- Halogen organic solvent (HCFC225, etc.)
- Alcoholic solvent (IPA, ethanol, etc.)
- Petroleum solvent, alkali saponifying agent, water, etc.

Circuit board cleaning must be conducted at a temperature of not higher than 50°C and for an immersion time of not longer than 30 minutes. When an ultrasonic cleaning method is used, cleaning must be conducted at a frequency of 48 kHz or lower, at a vibrator output of 0.02 W/cm³, at a temperature of not higher than 40°C, and for a time of 5 minutes or shorter.

NOTE 1: Care must be exercised in cleaning process so that the mounted capacitor will not come into contact with any cleaned object or the like or will not get rubbed by a stiff brush or the like. If such precautions are not taken particularly when the ultrasonic cleaning method is employed, terminal breakage may occur.

NOTE 2: When performing ultrasonic cleaning under conditions other than stated above, conduct adequate advance checkout.

● **OTHER**

- ▷ For further details, refer to EIAJ RCR-2368, Precautions and Guidelines for Using Electronic Device Tantalum Capacitors.
- ▷ If you have any questions, feel free to contact your local SAMSUNG ELECTRO-MECHANICS agent.