

# Notice for TAIYO YUDEN products

Please read this notice before using the TAIYO YUDEN products.

## REMINDERS

- Product information in this catalog is as of October 2011. All of the contents specified herein are subject to change without notice due to technical improvements, etc. Therefore, please check for the latest information carefully before practical application or usage of the Products.

Please note that Taiyo Yuden Co., Ltd. shall not be responsible for any defects in products or equipment incorporating such products, which are caused under the conditions other than those specified in this catalog or individual specification.

- Please contact Taiyo Yuden Co., Ltd. for further details of product specifications as the individual specification is available.
- Please conduct validation and verification of products in actual condition of mounting and operating environment before commercial shipment of the equipment.
- All electronic components or functional modules listed in this catalog are developed, designed and intended for use in general electronics equipment.(for AV, office automation, household, office supply, information service, telecommunications, (such as mobile phone or PC) etc.). Before incorporating the components or devices into any equipment in the field such as transportation,( automotive control, train control, ship control), transportation signal, disaster prevention, medical, public information network (telephone exchange, base station) etc. which may have direct influence to harm or injure a human body, please contact Taiyo Yuden Co., Ltd. for more detail in advance. Do not incorporate the products into any equipment in fields such as aerospace, aviation, nuclear control, submarine system, military, etc. where higher safety and reliability are especially required.

In addition, even electronic components or functional modules that are used for the general electronic equipment, if the equipment or the electric circuit require high safety or reliability function or performances, a sufficient reliability evaluation check for safety shall be performed before commercial shipment and moreover, due consideration to install a protective circuit is strongly recommended at customer's design stage.

- The contents of this catalog are applicable to the products which are purchased from our sales offices or distributors (so called "TAIYO YUDEN' s official sales channel").  
It is only applicable to the products purchased from any of TAIYO YUDEN' s official sales channel.
- Please note that Taiyo Yuden Co., Ltd. shall have no responsibility for any controversies or disputes that may occur in connection with a third party's intellectual property rights and other related rights arising from your usage of products in this catalog. Taiyo Yuden Co., Ltd. grants no license for such rights.
- Caution for export  
Certain items in this catalog may require specific procedures for export according to "Foreign Exchange and Foreign Trade Control Law" of Japan, "U.S. Export Administration Regulations", and other applicable regulations. Should you have any question or inquiry on this matter, please contact our sales staff.

# MULTILAYER CHIP BEAD INDUCTORS (BK ARRAY SERIES)



REFLOW

## FEATURES

- Available in a wide range of frequency characteristics and impedance values providing excellent suppression of various noise.
- 4 line action in one chip is available for mounting with higher density and efficiency.
- Heat generation and crosstalk between adjacent circuits are minimized.

## APPLICATIONS

- Radiated noise suppression in note-PC, LCD module and other portable equipment.
- Radiated noise suppression in interfaces and harness connecting parts.

## OPERATING TEMP.

- 55~125°C

## ORDERING CODE

B K 3 2 1 6 4 S 6 0 1 - T ○

<b>1</b> Type	<b>2</b> External Dimension (L×W) (mm)	<b>3</b> Material	<b>4</b> Nominal Impedance (Ω)	<b>5</b> Packaging	<b>6</b> Internal code
BK Multilayer chip bead inductor	2010(0804) 2.0×1.0 3216(1206) 3.2×1.6	4W 4S 4M 4L Refer to impedance curves for material difference	example 601 600 102 1000	-T Tape & Reel	△ Standard Products △=Blank Space

## EXTERNAL DIMENSIONS/STANDARD QUANTITY

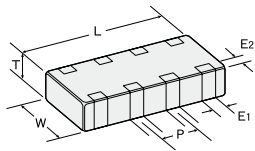

Type	Material	L	W	T	E1	E2	P	Standard Quantity [pcs]	
								Paper Tape	Embossed Tape
BK2010 (0804)	4W, 4S, 4M, 4L	2.0±0.15 (0.079±0.006)	1.0±0.15 (0.039±0.006)	0.45±0.05 (0.018±0.002)	0.25 <sup>+0.15</sup> <sub>-0.1</sub> (0.010 <sup>+0.006</sup> <sub>-0.004</sub> )	0.25±0.15 (0.010±0.006)	0.5±0.1 (0.020±0.004)	4000	-
BK3216 (1206)	4W, 4S, 4M, 4L	3.2±0.2 (0.126±0.008)	1.6±0.2 (0.063±0.008)	0.8±0.1 (0.031±0.004)	0.35±0.2 (0.014±0.008)	0.3±0.2 (0.012±0.008)	0.8±0.1 (0.031±0.004)	-	4000

Unit : mm (inch)

## AVAILABLE MATERIALS

### BK2010

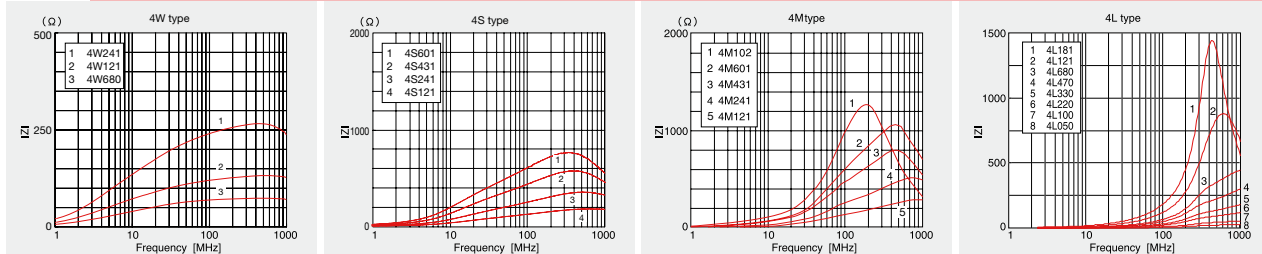

### BK3216

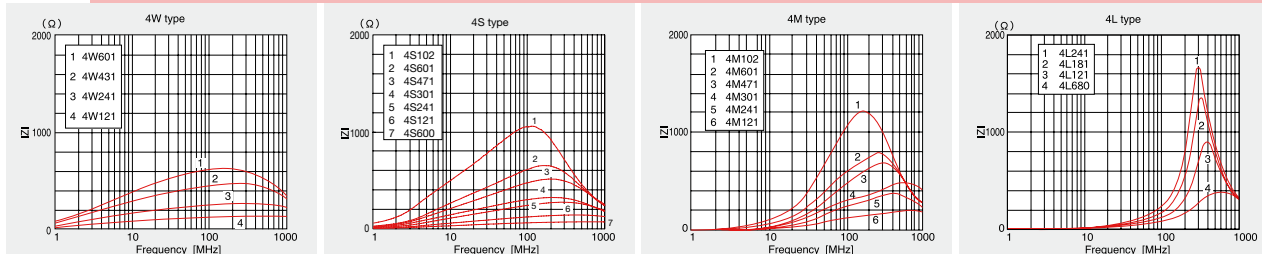

\* This catalog contains the typical specification only due to the limitation of space. When you consider the purchase of our products, please check our specification. For details of each product (characteristics graph, reliability information, precautions for use, and so on), see our Web site (<http://www.ty-top.com/>) or CD catalogs.

■ PART NUMBERS

● BK2010

Ordering code		EHS (Environmental Hazardous Substances)	Impedance [ $\Omega$ ] $\pm 25\%$	Measuring Frequency (MHz)	DC Resistance [ $\Omega$ ] (max.)	Rated current (mA) (max.)
BK2010 4W680		RoHS	68	100	0.35	100
BK2010 4W121		RoHS	120		0.40	
BK2010 4W241		RoHS	240		0.50	
BK2010 4S121		RoHS	120		0.30	
BK2010 4S241		RoHS	240		0.45	
BK2010 4S431		RoHS	430		0.55	
BK2010 4S601		RoHS	600		0.70	
BK2010 4M121		RoHS	120		0.30	
BK2010 4M241		RoHS	240		0.45	
BK2010 4M431		RoHS	430		0.55	
BK2010 4M601		RoHS	600		0.70	
BK2010 4M102		RoHS	1000		0.80	
BK2010 4L050		RoHS	5		0.10	
BK2010 4L100		RoHS	10		0.15	
BK2010 4L220		RoHS	22		0.20	
BK2010 4L330		RoHS	33		0.30	
BK2010 4L470		RoHS	47		0.40	
BK2010 4L680		RoHS	68		0.50	
BK2010 4L121		RoHS	120		0.70	
BK2010 4L181		RoHS	180		0.90	

● BK3216

Ordering code		EHS (Environmental Hazardous Substances)	Impedance [ $\Omega$ ] $\pm 25\%$	Measuring Frequency (MHz)	DC Resistance [ $\Omega$ ] (max.)	Rated current (mA) (max.)
BK3216 4W121		RoHS	120	100	0.15	100
BK3216 4W241		RoHS	240		0.25	100
BK3216 4W431		RoHS	430		0.35	100
BK3216 4W601		RoHS	600		0.40	100
BK3216 4S600		RoHS	60		0.18	200
BK3216 4S121		RoHS	120		0.18	200
BK3216 4S241		RoHS	240		0.30	200
BK3216 4S301		RoHS	300		0.40	200
BK3216 4S471		RoHS	470		0.40	200
BK3216 4S601		RoHS	600		0.45	200
BK3216 4S102		RoHS	1000		0.68	100
BK3216 4M121		RoHS	120		0.20	150
BK3216 4M241		RoHS	240		0.35	150
BK3216 4M301		RoHS	300		0.45	150
BK3216 4M471		RoHS	470		0.50	150
BK3216 4M601		RoHS	600		0.60	100
BK3216 4M102		RoHS	1000		0.80	100
BK3216 4L680		RoHS	68		0.35	200
BK3216 4L121		RoHS	120		0.55	200
BK3216 4L181		RoHS	180		0.65	150
BK3216 4L241		RoHS	240	0.75	150	

\* This catalog contains the typical specification only due to the limitation of space. When you consider the purchase of our products, please check our specification. For details of each product (characteristics graph, reliability information, precautions for use, and so on), see our Web site (<http://www.ty-top.com/>) or CD catalogs.

BK2010

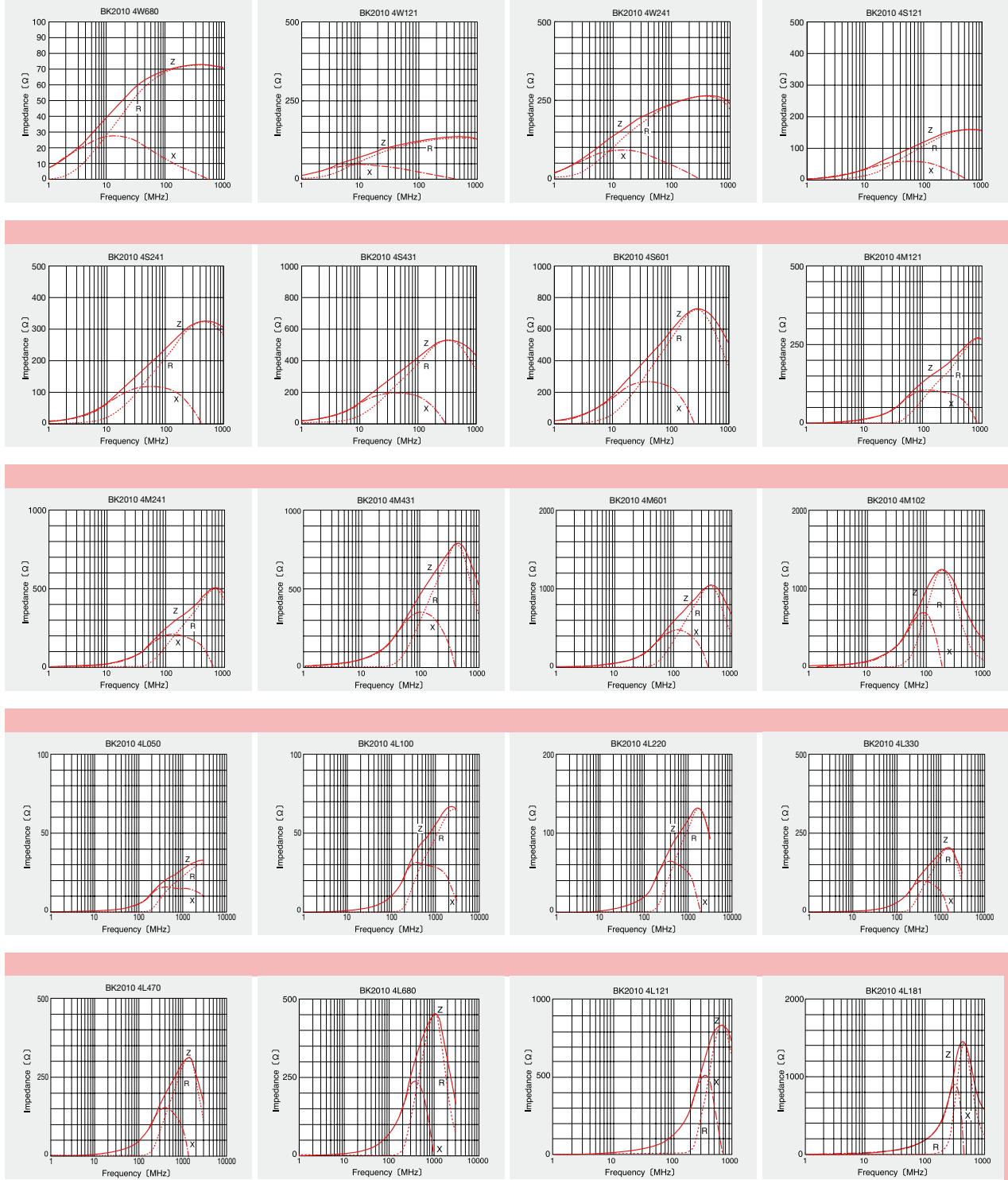

\* This catalog contains the typical specification only due to the limitation of space. When you consider the purchase of our products, please check our specification. For details of each product (characteristics graph, reliability information, precautions for use, and so on), see our Web site (<http://www.ty-top.com/>) or CD catalogs.

BK3216

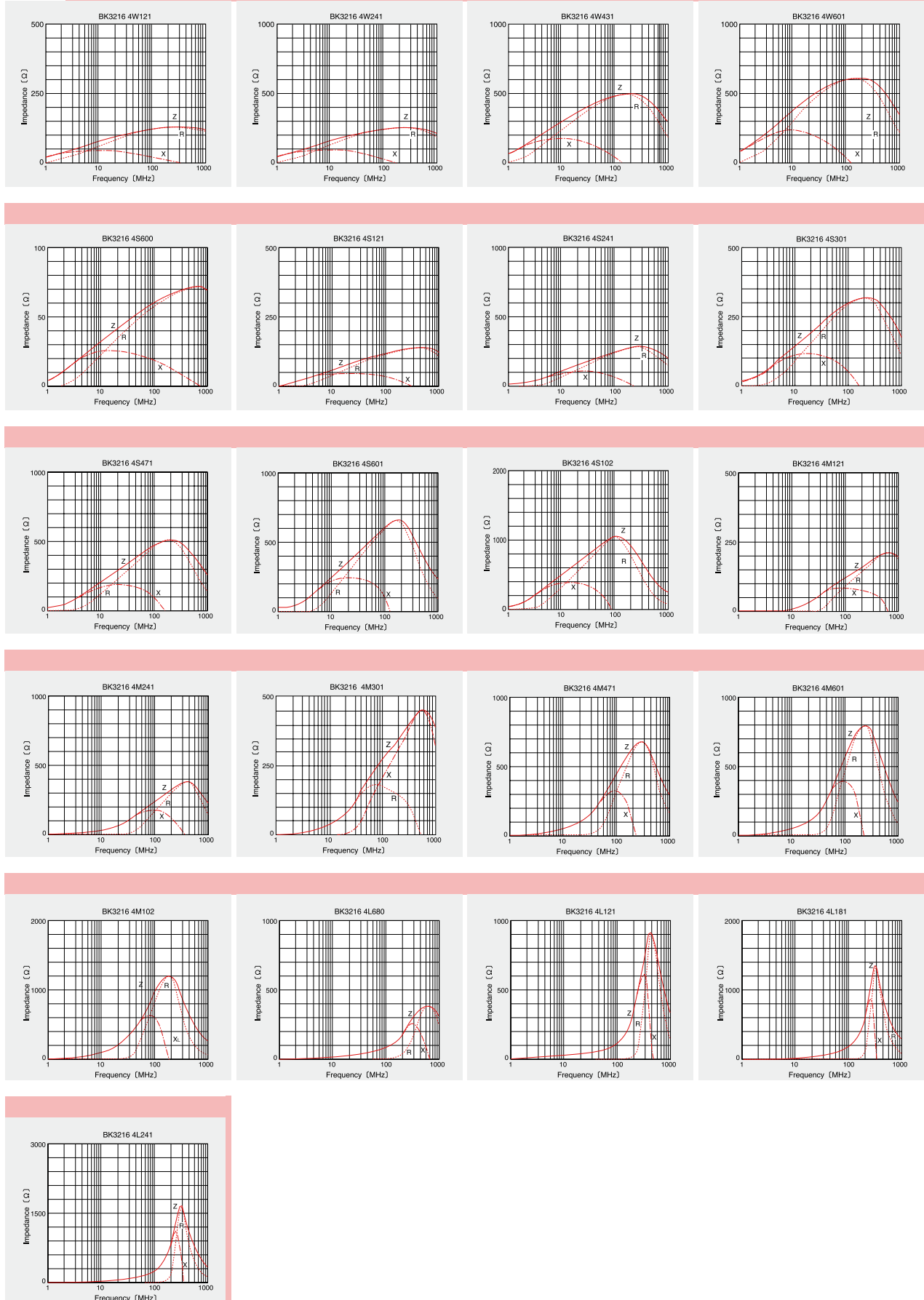

\* This catalog contains the typical specification only due to the limitation of space. When you consider the purchase of our products, please check our specification. For details of each product (characteristics graph, reliability information, precautions for use, and so on), see our Web site (<http://www.ty-top.com/>) or CD catalogs.

# PACKAGING

## ① Minimum Quantity

### ● Tape & Reel Packaging

Type	Thickness [mm] (inch)	Standard Quantity [pcs]	
		Paper Tape	Embossed Tape
CK1608(0603)	0.8 (0.031)	4000	—
CK2125(0805)	0.85 (0.033)	4000	—
	1.25 (0.049)	—	2000
CKS2125(0805)	0.85 (0.033)	4000	—
	1.25 (0.049)	—	2000
CKP2012(0805)	0.9 (0.035)	—	3000
CKP2016(0806)	0.9 (0.035)	—	3000
CKP2520(1008)	0.7 (0.028)	—	3000
	0.9 (0.035)	—	3000
	1.1 (0.043)	—	2000
NM2012(0805)	0.9 (0.035)	—	3000
NM2520(1008)	1.1 (0.043)	—	2000
LK1005(0402)	0.5 (0.020)	10000	—
LK1608(0603)	0.8 (0.031)	4000	—
LK2125(0805)	0.85 (0.033)	4000	—
	1.25 (0.049)	—	2000
HK0402(01005)	0.2 (0.008)	20000	—
HK0603(0201)	0.3 (0.012)	15000	—
HK1005(0402)	0.5 (0.020)	10000	—
HK1608(0603)	0.8 (0.031)	4000	—
HK2125(0805)	0.85 (0.033)	—	4000
	1.0 (0.039)	—	3000
HKQ0603S(0201)	0.3 (0.012)	15000	—
HKQ0603U(0201)	0.3 (0.012)	15000	—
AQ105(0402)	0.5 (0.020)	10000	—
BK0402(01005)	0.2 (0.008)	20000	—
BK0603(0201)	0.3 (0.012)	15000	—
BK1005(0402)	0.5 (0.020)	10000	—
BKH1005(0402)	0.5 (0.020)	10000	—
BK1608(0603)	0.8 (0.031)	4000	—
BK2125(0805)	0.85 (0.033)	4000	—
	1.25 (0.049)	—	2000
BK2010(0804)	0.45 (0.018)	4000	—
BK3216(1206)	0.8 (0.031)	—	4000
BKP0603(0201)	0.3 (0.012)	15000	—
BKP1005(0402)	0.5 (0.020)	10000	—
BKP1608(0603)	0.8 (0.031)	4000	—
BKP2125(0805)	0.85 (0.033)	4000	—

## ② Taping material

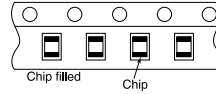
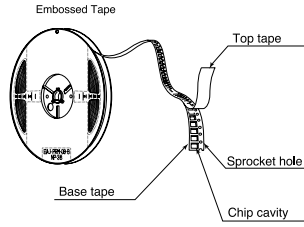
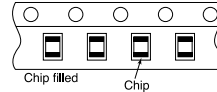
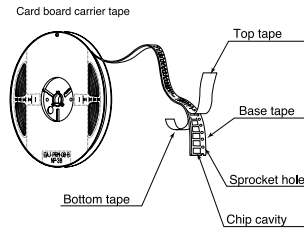

CK	1608
CK	2125
CK S	2125
L K	1005
L K	1608
L K	2125
HK	0402
HK	0603
HK	1005
HK	1608
HK Q	0603
A Q	105
B K	0402
B K	0603
B K	1005
B K	1608
B K	2125
B K	2010
B K P	0603
B K P	1005
B K P	1608
B K P	2125
B K H	1005

CK	2125
CK S	2125
CK P	2012
CK P	2016
CK P	2520
NM	2012
NM	2520
L K	2125
H K	2125
B K	2125
B K	3216

## ③ Taping Dimensions

### ● Paper tape (0.315 inches wide)

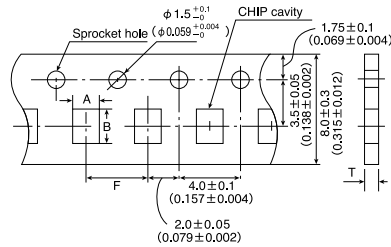

Unit : mm (inch)

Type	Thickness (mm) (inch)	Chip cavity		Insertion Pitch F	Tape Thickness T
		A	B		
CK1608(0603)	0.8 (0.031)	1.0±0.2 (0.039±0.008)	1.8±0.2 (0.071±0.008)	4.0±0.1 (0.157±0.004)	1.1m a x (0.043max)
CK2125(0805)	0.85 (0.033)	1.5±0.2 (0.059±0.008)	2.3±0.2 (0.091±0.008)	4.0±0.1 (0.157±0.004)	1.1m a x (0.043max)
	0.85 (0.033)	1.5±0.2 (0.059±0.008)	2.3±0.2 (0.091±0.008)	4.0±0.1 (0.157±0.004)	1.1m a x (0.043max)
LK1005(0402)	0.5 (0.020)	0.65±0.1 (0.026±0.004)	1.15±0.1 (0.045±0.004)	2.0±0.05 (0.079±0.002)	0.8m a x (0.031max)
LK1608(0603)	0.8 (0.031)	1.0±0.2 (0.039±0.008)	1.8±0.2 (0.071±0.008)	4.0±0.1 (0.157±0.004)	1.1m a x (0.043max)
LK2125(0805)	0.85 (0.033)	1.5±0.2 (0.059±0.008)	2.3±0.2 (0.091±0.008)	4.0±0.1 (0.157±0.004)	1.1m a x (0.043max)
	1.25 (0.049)	—	—	—	2000
HK0402(01005)	0.2 (0.008)	0.25±0.04 (0.010±0.002)	0.45±0.04 (0.018±0.002)	2.0±0.05 (0.079±0.002)	0.36m a x (0.014max)
HK0603(0201)	0.3 (0.012)	0.40±0.06 (0.016±0.002)	0.70±0.06 (0.028±0.002)	2.0±0.05 (0.079±0.002)	0.45m a x (0.018max)
HK1005(0402)	0.5 (0.020)	0.65±0.1 (0.026±0.004)	1.15±0.1 (0.045±0.004)	2.0±0.05 (0.079±0.002)	0.8m a x (0.031max)
HK1608(0603)	0.8 (0.031)	1.0±0.2 (0.039±0.008)	1.8±0.2 (0.071±0.008)	4.0±0.1 (0.157±0.004)	1.1m a x (0.043max)
HKQ0603S(0201)	0.3 (0.012)	0.40±0.06 (0.016±0.002)	0.70±0.06 (0.028±0.002)	2.0±0.05 (0.079±0.002)	0.45m a x (0.018max)
HKQ0603U(0201)	0.3 (0.012)	0.40±0.06 (0.016±0.002)	0.70±0.06 (0.028±0.002)	2.0±0.05 (0.079±0.002)	0.45m a x (0.018max)
AQ105(0402)	0.5 (0.020)	0.75±0.1 (0.030±0.004)	1.15±0.1 (0.045±0.004)	2.0±0.05 (0.079±0.002)	0.8m a x (0.031max)

To next page

\* This catalog contains the typical specification only due to the limitation of space. When you consider the purchase of our products, please check our specification. For details of each product (characteristics graph, reliability information, precautions for use, and so on), see our Web site (<http://www.ty-top.com/>) or CD catalogs.

**PACKAGING**

Type	Thickness (mm) (inch)	Chip cavity		Insertion Pitch F	Tape Thickness T	
		A	B			
BK0402(01005)	0.2 (0.008)	0.25±0.04 (0.010±0.002)	0.45±0.04 (0.018±0.002)	2.0±0.05 (0.079±0.002)	0.36m x (0.014max)	
BK0603(0201)	0.3 (0.012)	0.40±0.06 (0.016±0.002)	0.70±0.06 (0.028±0.002)	2.0±0.05 (0.079±0.002)	0.45m x (0.018max)	
BK1005(0402)	0.5 (0.020)	0.65±0.1 (0.026±0.004)	1.15±0.1 (0.045±0.004)	2.0±0.05 (0.079±0.002)	0.8m x (0.031max)	
BK1608(0603)	0.8 (0.031)	1.0±0.2 (0.039±0.008)	1.8±0.2 (0.071±0.008)	4.0±0.1 (0.157±0.004)	1.1m x (0.043max)	
BK2125(0805)	0.85 (0.033)	1.5±0.2 (0.059±0.008)	2.3±0.2 (0.091±0.008)	4.0±0.1 (0.157±0.004)	1.1m x (0.043max)	
BK2010(0804)	0.45 (0.018)	1.2±0.1 (0.047±0.004)	2.17±0.1 (0.085±0.004)	4.0±0.1 (0.157±0.004)	0.8m x (0.031max)	
BKP0603(0201)	0.3 (0.012)	0.40±0.06 (0.016±0.002)	0.70±0.06 (0.028±0.002)	2.0±0.05 (0.079±0.002)	0.45m x (0.018max)	
BKP1005(0402)	0.5 (0.020)	0.65±0.1 (0.026±0.004)	1.15±0.1 (0.045±0.004)	2.0±0.05 (0.079±0.002)	0.8m x (0.031max)	
BKP1608(0603)	0.8 (0.031)	1.0±0.2 (0.039±0.008)	1.8±0.2 (0.071±0.008)	4.0±0.1 (0.157±0.004)	1.1m x (0.043max)	
BKP2125(0805)	0.85 (0.033)	1.5±0.2 (0.059±0.008)	2.3±0.2 (0.091±0.008)	4.0±0.1 (0.157±0.004)	1.1m x (0.043max)	
BKH1005(0805)	0.5 (0.020)	0.65±0.1 (0.026±0.004)	1.15±0.1 (0.045±0.004)	2.0±0.05 (0.079±0.002)	0.8m x (0.031max)	

Unit : mm (inch)

● Embossed Tape (0.315 inches wide)

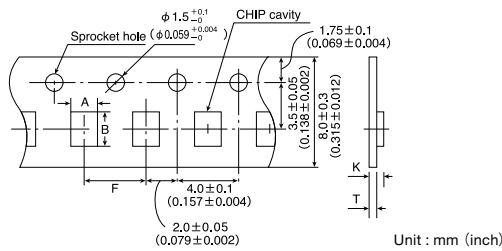

Unit : mm (inch)

Type	Thickness (mm) (inch)	Chip cavity		Insertion Pitch F	Tape Thickness K, T	
		A	B		K	T
CK2125(0805)	1.25 (0.049)	1.5±0.2 (0.059±0.008)	2.3±0.2 (0.091±0.008)	4.0±0.1 (0.157±0.004)	2.0 (0.079)	0.3 (0.012)
CKS2125(0805)	1.25 (0.049)	1.5±0.2 (0.059±0.008)	2.3±0.2 (0.091±0.008)	4.0±0.1 (0.157±0.004)	2.0 (0.079)	0.3 (0.012)
CKP2012(0805)	0.9 (0.035)	1.55±0.2 (0.061±0.008)	2.3±0.2 (0.091±0.008)	4.0±0.1 (0.157±0.004)	1.3 (0.051)	0.3 (0.012)
CKP2016(0806)	0.9 (0.035)	1.8±0.1 (0.071±0.004)	2.2±0.1 (0.087±0.004)	4.0±0.1 (0.157±0.004)	1.3 (0.051)	0.25 (0.01)
CKP2520(1008)	0.7 (0.028)	2.3±0.1 (0.091±0.004)	2.8±0.1 (0.110±0.004)	4.0±0.1 (0.157±0.004)	1.4 (0.055)	0.3 (0.012)
	0.9 (0.035)				1.4 (0.055)	
	1.1 (0.043)				1.7 (0.067)	
NM2012(0805)	0.9 (0.035)	1.55±0.2 (0.061±0.008)	2.3±0.2 (0.091±0.008)	4.0±0.1 (0.157±0.004)	1.3 (0.051)	0.3 (0.012)
NM2520(1008)	1.1 (0.043)	2.3±0.1 (0.091±0.004)	2.8±0.1 (0.110±0.004)	4.0±0.1 (0.157±0.004)	1.7 (0.067)	0.3 (0.012)
LK2125(0805)	1.25 (0.049)	1.5±0.2 (0.059±0.008)	2.3±0.2 (0.091±0.008)	4.0±0.1 (0.157±0.004)	2.0 (0.079)	0.3 (0.012)
HK2125(0805)	0.85 (0.033)	1.5±0.2 (0.059±0.008)	2.3±0.2 (0.091±0.008)	4.0±0.1 (0.157±0.004)	1.5 (0.059)	0.3 (0.012)
	1.0 (0.039)				2.0 (0.079)	
BK2125(0805)	1.25 (0.049)	1.5±0.2 (0.059±0.008)	2.3±0.2 (0.091±0.008)	4.0±0.1 (0.157±0.004)	2.0 (0.079)	0.3 (0.012)
BK3216(1206)	0.8 (0.031)	1.9±0.1 (0.075±0.004)	3.5±0.1 (0.138±0.004)	4.0±0.1 (0.157±0.004)	1.4 (0.055)	0.3 (0.012)

④ LEADER AND BLANK PORTION

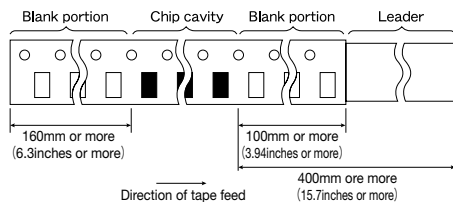

⑤ Reel Size

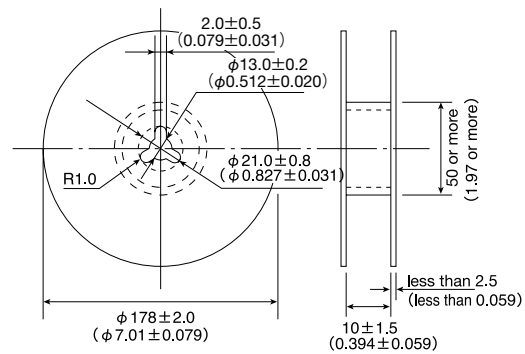

⑥ Top tape strength

The top tape requires a peel-off force of 0.1~0.7N in the direction of the arrow as illustrated below.

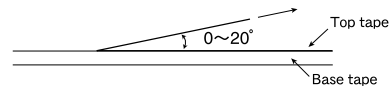

\* This catalog contains the typical specification only due to the limitation of space. When you consider the purchase of our products, please check our specification. For details of each product (characteristics graph, reliability information, precautions for use, and so on), see our Web site (<http://www.ty-top.com/>) or CD catalogs.

## RELIABILITY DATA

### Multilayer chip inductors and beads

#### 1. Operating Temperature Range

BK0402		
BK0603		
BK1005		
BKH1005		
BK1608		-55~+125°C
BK2125		
ARRAY	BK2010	
	BK3216	
BKP0603		
BKP1005		
BKP1608		-55~+85°C
BKP2125		
CK1608		
CK2125		
CKS2125		
CKP2012		
CKP2016		
CKP2520		-40~+85°C
NM2012		
NM2520		
LK1005		
LK1608		
LK2125		
HK0402		
HK0603		-55~+125°C
HK1005		
HK1608		-40~+85°C
HK2125		
HKQ0603S		
HKQ0603U		-55~+125°C
AQ105		

#### 2. Storage Temperature Range

BK0402		
BK0603		
BK1005		
BKH1005		
BK1608		-55~+125°C
BK2125		
ARRAY	BK2010	
	BK3216	
BKP0603		
BKP1005		
BKP1608		-55~+85°C
BKP2125		
CK1608		
CK2125		
CKS2125		
CKP2012		
CKP2016		
CKP2520		-40~+85°C
NM2012		
NM2520		
LK1005		
LK1608		
LK2125		
HK0402		
HK0603		-55~+125°C
HK1005		
HK1608		-40~+85°C
HK2125		
HKQ0603S		
HKQ0603U		-55~+125°C
AQ105		

\* This catalog contains the typical specification only due to the limitation of space. When you consider the purchase of our products, please check our specification. For details of each product (characteristics graph, reliability information, precautions for use, and so on), see our Web site (<http://www.ty-top.com/>) or CD catalogs.



## RELIABILITY DATA

### Multilayer chip inductors and beads

3. Rated Current		
BK0402	240~540mA DC	
BK0603	100~500mA DC	
BK1005	120~1000mA DC	
BKH1005	200mA DC	
BK1608	150~1500mA DC	
BK2125	200~1200mA DC	
ARRAY	BK2010	100mA DC
	BK3216	100~200mA DC
BKP0603	1.0A DC	
BKP1005	800~2000mA DC	
BKP1608	1.0~3.0A DC	
BKP2125	1.5~4.0A DC	
CK1608	50~60mA DC	
CK2125	60~500mA DC	
CKS2125	110~280mA DC	
CKP2012	0.7~1.2A DC	
CKP2016	0.9~1.6A DC	
CKP2520	1.1~1.8A DC	
NM2012	0.8~1.5A DC	
NM2520	0.9~1.1A DC	
LK1005	20~25mA DC	
LK1608	1~150mA DC	
LK2125	5~300mA DC	
HK0402	160~380mA DC	
HK0603	60~470mA DC	
HK1005	110~300mA DC	
HK1608	150~300mA DC	
HK2125	300mA DC	
HKQ0603S	130~600mA DC	
HKQ0603U	130~600mA DC	
AQ105	280~710mA DC	

#### Definition of rated current :

- In the CK, CKS and BK Series, the rated current is the value of current at which the temperature of the element is increased within 20°C.
- In the BK Series P type and CK Series P type, NM Series the rated current is the value of current at which the temperature of the element is increased within 40°C.
- In the LK, HK, HKQ, and AQ Series, the rated current is either the DC value at which the internal L value is decreased within 5% with the application of DC bias, or the value of current at which the temperature of the element is increased within 20°C.

4. Impedance		
BK0402	10~120Ω ±25%	
BK0603	10~600Ω ±25%	
BK1005	10~1800Ω ±25%	
BKH1005	1500~1800Ω ±25%	
BK1608	22~2500Ω ±25%	
BK2125	15~2500Ω ±25%	
ARRAY	BK2010	5~1000Ω ±25%
	BK3216	68~1000Ω ±25%
BKP0603	22~33Ω ±25%	
BKP1005	10~220Ω ±25%	
BKP1608	33~470Ω ±25%	
BKP2125	33~330Ω ±25%	
CK1608		
CK2125		
CKS2125		
CKP2012		
CKP2016		
CKP2520		
NM2012		
NM2520		
LK1005		
LK1608		
LK2125		
HK0402		
HK0603		
HK1005		
HK1608		
HK2125		
HKQ0603S		
HKQ0603U		
AQ105		

#### [Test Methods and Remarks]

##### BK0402 Series

Measuring frequency : 100±1MHz  
 Measuring equipment : E4991A(or its equivalent)  
 Measuring jig : 16196D(or its equivalent)

##### BK0603 Series, BKP0603 Series

Measuring frequency : 100±1MHz  
 Measuring equipment : 4291A(or its equivalent)  
 Measuring jig : 16193A(or its equivalent)

##### BK1005 Series, BKP1005 Series, BKH1005 Series

Measuring frequency : 100±1MHz  
 Measuring equipment : 4291A(or its equivalent)  
 Measuring jig : 16192A(or its equivalent), 16193A(or its equivalent)

##### BK1608·2125 Series, BKP1608·2125 Series

Measuring frequency : 100±1MHz  
 Measuring equipment : 4291A(or its equivalent), 4195A(or its equivalent)  
 Measuring jig : 16092A(or its equivalent) or 16192A(or its equivalent)/HW

##### BK2010·3216 Series

Measuring frequency : 100±1MHz  
 Measuring equipment : 4291A(or its equivalent), 4195A(or its equivalent)  
 Measuring jig : 16192A(or its equivalent)

\* This catalog contains the typical specification only due to the limitation of space. When you consider the purchase of our products, please check our specification. For details of each product (characteristics graph, reliability information, precautions for use, and so on), see our Web site (<http://www.ty-top.com/>) or CD catalogs.

**RELIABILITY DATA**

Multilayer chip inductors and beads

5. Inductance	
BK0402	
BK0603	
BK1005	
BKH1005	
BK1608	
BK2125	
ARRAY	BK2010 BK3216
BKP0603	
BKP1005	
BKP1608	
BKP2125	
CK1608	4.7~10.0μH : ±20%
CK2125	0.1~10.0μH : ±20%
CKS2125	1.0~10.0μH : ±20%
CKP2012	0.47~4.7μH : ±20%
CKP2016	0.47~4.7μH : ±20%
CKP2520	0.47~4.7μH : ±20%
NM2012	0.82~1.0μH : ±20%
NM2520	1.0~2.2μH : ±20%
LK1005	0.12~2.2μH : ±10% Q 0.12~2.2μH : ±30%
LK1608	0.047~33.0μH : ±20% 0.10~12.0μH : ±10% Q 0.12~2.2μH : ±30%
LK2125	0.047~33.0μH : ±20% 0.10~12.0μH : ±10% Q 0.12~2.2μH : ±30%
HK0402	1.0~6.2nH : ±0.3nH 6.8~12nH : ±5%
HK0603	1.0~6.2nH : ±0.3nH 6.8~100nH : ±5%
HK1005	1.0~6.2nH : ±0.3nH 6.8~270nH : ±5%
HK1608	1.0~5.6nH : ±0.3nH 6.8~470nH : ±5%
HK2125	1.5~5.6nH : ±0.3nH 6.8~470nH : ±5%
HKQ0603S	0.6~6.2nH : ±0.3nH 6.8~22nH : ±5%
HKQ0603U	0.6~6.2nH : ±0.3nH 6.8~22nH : ±5%
AQ105	1.0~6.2nH : ±0.3nH 6.8~15nH : ±5%

[Test Methods and Remarks]

CK Series :

- Measuring frequency : 2 to 4MHz (CK1608)
- Measuring frequency : 2 to 25MHz (CK2125)
- Measuring frequency : 2 to 10MHz (CKS2125)

LK Series :

- Measuring frequency : 10 to 25MHz (LK1005)
- Measuring frequency : 1 to 50MHz (LK1608)
- Measuring frequency : 0.4 to 50MHz (LK2125)

CKP Series, NM Series :

- Measuring frequency : 1MHz(CKP2012, CKP2016, CKP2520, NM2012・NM2520)
- Measuring equipment, jig :
  - ・4194A+16085B+16092A(or its equivalent)
  - ・4195A+41951+16092A(or its equivalent)
  - ・4294A+16192A(or its equivalent)
  - ・4291A+16193A(or its equivalent)/LK1005
  - ・4285A+42841A+42842C+42851—61100(CKP2012・CKP2016・CKP2520・NM2012・NM2520)
- Measuring current : ・1mA rms(0.047 to 4.7μH) ・0.1mA rms(5.6 to 33μH)

HK、HKQ、AQ Series :

- Measuring frequency : 100MHz(HK0402・HK0603・HK1005・AQ105)
- Measuring frequency : 50/100MHz(HK1608・HK2125)
- Measuring frequency : 500MHz(HKQ0603S・HKQ0603U)
- Measuring equipment, jig :
  - ・4291A+16197A(or its equivalent)/HK0603・AQ105
  - ・4291A+16193A(or its equivalent)/HK1005
  - ・E4991A+16197A(or its equivalent)/HKQ0603S・HKQ0603U
  - ・4291A+16092+in-house made jig(or its equivalent)/HK1608・HK2125
  - ・E4991A+16196D(or its equivalent)/HK0402

\* This catalog contains the typical specification only due to the limitation of space. When you consider the purchase of our products, please check our specification. For details of each product (characteristics graph, reliability information, precautions for use, and so on), see our Web site (<http://www.ty-top.com/>) or CD catalogs.

**RELIABILITY DATA**

Multilayer chip inductors and beads

6. Q	
BK0402	
BK0603	
BK1005	
BKH1005	
BK1608	
BK2125	
ARRAY	BK2010 BK3216
BKP0603	
BKP1005	
BKP1608	
BKP2125	
CK1608	20 min.
CK2125	15~20 min.
CKS2125	
CKP2012	
CKP2016	
CKP2520	
NM2012	
NM2520	
LK1005	10~20 min.
LK1608	10~35 min.
LK2125	15~50 min.
HK0402	3 min.
HK0603	4~5 min.
HK1005	8 min.
HK1608	8~12 min.
HK2125	10~18 min.
HKQ0603S	10~13 min.
HKQ0603U	10~13 min.
AQ105	8 min.

**[Test Methods and Remarks]**

**CK Series :**

Measuring frequency : 2 to 4MHz(CK1608)  
Measuring frequency : 2 to 25MHz(CK2125)

**LK Series :**

Measuring frequency : 10 to 25MHz(LK1005)  
Measuring frequency : 1 to 50MHz(LK1608)  
Measuring frequency : 0.4 to 50MHz(LK2125)  
Measuring equipment, jig : ·4194A+16085B+16092A(or its equivalent)  
·4195A+41951+16092A(or its equivalent)  
·4294A+16192A(or its equivalent)  
·4291A+16193A(or its equivalent)/LK1005

Measuring current : ·1mA rms(0.047 to 4.7μH) ·0.1mA rms(5.6 to 33μH)

**HK, HKQ, AQ Series :**

Measuring frequency : 100MHz(HK0603·HK1005·AQ105)  
Measuring frequency : 50/100MHz(HK1608·HK2125)  
Measuring frequency : 500MHz(HKQ0603S·HKQ0603U)  
Measuring equipment, jig : ·4291A+16197A(or its equivalent)/HK0603·AQ105  
·4291A+16193A(or its equivalent)/HK1005  
·E4991A+16197A(or its equivalent)/HKQ0603S·HKQ0603U  
·4291A+16092A+ in-house made jig(or its equivalent)/HK1608·HK2125  
·E4991A+16196D(or its equivalent)HK0402

7. DC Resistance

BK0402	0.10~0.53Ω max.
BK0603	0.065~1.50Ω max.
BK1005	0.03~0.80Ω max.
BKH1005	1.50~2.00Ω max.
BK1608	0.05~1.10Ω max.
BK2125	0.05~0.75Ω max.
ARRAY	BK2010 BK3216
BKP0603	0.065~0.070Ω max.
BKP1005	0.030~0.20Ω max.
BKP1608	0.025~0.18Ω max.
BKP2125	0.020~0.075Ω max.
CK1608	0.45~0.85Ω (±30%)
CK2125	0.16~0.65Ω max.
CKS2125	0.09~0.40Ω typ. 0.12~0.52Ω max.
CKP2012	0.10~0.28Ω max.
CKP2016	0.08~0.20Ω max.
CKP2520	0.05~0.16Ω max.
NM2012	0.10~0.19Ω max.
NM2520	0.13~0.22Ω max.
LK1005	0.41~1.16Ω max.
LK1608	0.2~2.2Ω max.
LK2125	0.1~1.1Ω max.
HK0402	0.18~0.99Ω max.
HK0603	0.11~3.74Ω max.
HK1005	0.08~4.8Ω max.
HK1608	0.05~2.6Ω max.
HK2125	0.10~1.5Ω max.
HKQ0603S	0.06~1.29Ω max.
HKQ0603U	0.06~1.29Ω max.
AQ105	0.07~0.45Ω max.

**[Test Methods and Remarks]**

Measuring equipment : VOAC-7412(made by Iwasaki Tsushinki) VOAC-7512(made by Iwasaki Tsushinki)

\* This catalog contains the typical specification only due to the limitation of space. When you consider the purchase of our products, please check our specification. For details of each product (characteristics graph, reliability information, precautions for use, and so on), see our Web site (<http://www.ty-top.com/>) or CD catalogs.

## RELIABILITY DATA

### Multilayer chip inductors and beads

8. Self Resonance Frequency (SRF)	
BK0402	
BK0603	
BK1005	
BKH1005	
BK1608	
BK2125	
ARRAY	BK2010 BK3216
BKP0603	
BKP1005	
BKP1608	
BKP2125	
CK1608	17~25MHz min.
CK2125	24~235MHz min.
CKS2125	
CKP2012	
CKP2016	
CKP2520	
NM2012	
NM2520	
LK1005	40~180MHz min.
LK1608	9~260MHz min.
LK2125	13~320MHz min.
HK0402	29000~10000MHz min.
HK0603	900~10000MHz min.
HK1005	400~10000MHz min.
HK1608	300~10000MHz min.
HK2125	200~4000MHz min.
HKQ0603S	1900~10000MHz min.
HKQ0603U	1900~10000MHz min.
AQ105	2300~10000MHz min.
【Test Methods and Remarks】	
LK Series :	
Measuring equipment : 4195A (or its equivalent)	
Measuring jig : 41951+16092A (or its equivalent)	
HK、HKQ、AQ Series :	
Measuring equipment : 8719C (or its equivalent) · 8753D (or its equivalent) /HK2125	

9. Temperature Characteristic	
BK0402	
BK0603	
BK1005	
BKH1005	
BK1608	
BK2125	
ARRAY	BK2010 BK3216
BKP0603	
BKP1005	
BKP1608	
BKP2125	
CK1608	
CK2125	
CKS2125	
CKP2012	
CKP2016	
CKP2520	
NM2012	
NM2520	
LK1005	
LK1608	
LK2125	
HK0402	
HK0603	
HK1005	
HK1608	
HK2125	Inductance change : Within $\pm 10\%$
HKQ0603S	
HKQ0603U	
AQ105	
【Test Methods and Remarks】	
HK、HKQ、AQ Series : Temperature range : -30 to +85°C	
Reference temperature : +20°C	

\* This catalog contains the typical specification only due to the limitation of space. When you consider the purchase of our products, please check our specification.  
For details of each product (characteristics graph, reliability information, precautions for use, and so on), see our Web site (<http://www.ty-top.com/>) or CD catalogs.

**RELIABILITY DATA**

Multilayer chip inductors and beads

10. Resistance to Flexure of Substrate	
BK0402	
BK0603	
BK1005	
BKH1005	
BK1608	
BK2125	
ARRAY	BK2010 BK3216
BKP0603	
BKP1005	
BKP1608	
BKP2125	
CK1608	
CK2125	
CKS2125	
CKP2012	
CKP2016	
CKP2520	
NM2012	
NM2520	
LK1005	
LK1608	
LK2125	
HK0402	
HK0603	
HK1005	
HK1608	
HK2125	
HKQ0603S	
HKQ0603U	
AQ105	

No mechanical damage.

**[Test Methods and Remarks]**

Warp : 2mm (BK Series without 0402size, BKP, BKH, CK, CKS, CKP, NM, LK, HK, HKQ, AQ Series)  
 : 1mm (BK0402, HK0402 Series)  
 Testing board : glass epoxy-resin substrate  
 Thickness : 0.8mm

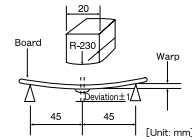

11. Solderability	
BK0402	
BK0603	
BK1005	
BKH1005	
BK1608	
BK2125	
ARRAY	BK2010 BK3216
BKP0603	
BKP1005	
BKP1608	
BKP2125	
CK1608	
CK2125	
CKS2125	
CKP2012	
CKP2016	
CKP2520	
NM2012	
NM2520	
LK1005	
LK1608	
LK2125	
HK0402	
HK0603	
HK1005	
HK1608	
HK2125	
HKQ0603S	
HKQ0603U	
AQ105	

At least 75% of terminal electrode is covered by new solder.

At least 75% of terminal electrode is covered by new solder.

**[Test Methods and Remarks]**

Solder temperature : 230±5°C  
 Duration : 4±1 sec.

\* This catalog contains the typical specification only due to the limitation of space. When you consider the purchase of our products, please check our specification. For details of each product (characteristics graph, reliability information, precautions for use, and so on), see our Web site (<http://www.ty-top.com/>) or CD catalogs.

## RELIABILITY DATA

### Multilayer chip inductors and beads

12. Resistance to Soldering	
BK0402	
BK0603	
BK1005	
BKH1005	
BK1608	
BK2125	Appearance : No significant abnormality. Impedance change : Within $\pm 30\%$
ARRAY	BK2010 BK3216
BKP0603	
BKP1005	
BKP1608	
BKP2125	
CK1608	
CK2125	No mechanical damage. Remaining terminal electrode : 70% min.
CKS2125	
CKP2012	Inductance change
CKP2016	R10~4R7 : Within $\pm 10\%$
CKP2520	6R8~100 : Within $\pm 15\%$
NM2012	CKS2125 : Within $\pm 20\%$
NM2520	CKP2012, CKP2016, CKP2520, NM2012, NM2520 : Within $\pm 30\%$
LK1005	No mechanical damage. Remaining terminal electrode : 70% min. Inductance change : Within $\pm 15\%$
LK1608	No mechanical damage.
LK2125	Remaining terminal electrode : 70% min. Inductance change 47N~4R7 : Within $\pm 10\%$ 5R6~330 : Within $\pm 15\%$
HK0402	
HK0603	
HK1005	
HK1608	No mechanical damage.
HK2125	Remaining terminal electrode : 70% min. Inductance change : Within $\pm 5\%$
HKQ0603S	
HKQ0603U	
AQ105	
[Test Methods and Remarks] Solder temperature : $260 \pm 5^\circ\text{C}$ Duration : $10 \pm 0.5$ sec. Preheating temperature : $150$ to $180^\circ\text{C}$ Preheating time : 3 min. Flux : Immersion into methanol solution with colophony for 3 to 5 sec. Recovery : 2 to 3 hrs of recovery under the standard condition after the test. (See Note 1)	

13. Thermal Shock	
BK0402	
BK0603	
BK1005	
BKH1005	
BK1608	
BK2125	Appearance : No significant abnormality. Impedance change : Within $\pm 30\%$
ARRAY	BK2010 BK3216
BKP0603	
BKP1005	
BKP1608	
BKP2125	
CK1608	No mechanical damage.
CK2125	Inductance change : Within $\pm 20\%$ Q change : Within $\pm 30\%$
CKS2125	Inductance change : Within $\pm 20\%$ (CKS2125)
CKP2012	
CKP2016	
CKP2520	No mechanical damage. Inductance change : Within $\pm 30\%$
NM2012	
NM2520	
LK1005	
LK1608	No mechanical damage.
LK2125	Inductance change : Within $\pm 10\%$ Q change : Within $\pm 30\%$
HK0402	
HK0603	
HK1005	
HK1608	No mechanical damage.
HK2125	Inductance change : Within $\pm 10\%$ Q change : Within $\pm 20\%$
HKQ0603S	
HKQ0603U	
AQ105	
[Test Methods and Remarks] Conditions for 1 cycle Step 1 : Minimum operating temperature $\pm 3^\circ\text{C}$ $30 \pm 3$ min. Step 2 : Room temperature 2 to 3 min. Step 3 : Maximum operating temperature $\pm 3^\circ\text{C}$ $30 \pm 3$ min. Step 4 : Room temperature 2 to 3 min. Number of cycles : 5 Recovery : 2 to 3 hrs of recovery under the standard condition after the test. (See Note 1)	

(Note 1) When there are questions concerning measurement result ; measurement shall be made after  $48 \pm 2$  hrs of recovery under the standard condition.

\* This catalog contains the typical specification only due to the limitation of space. When you consider the purchase of our products, please check our specification.  
For details of each product (characteristics graph, reliability information, precautions for use, and so on), see our Web site (<http://www.ty-top.com/>) or CD catalogs.

**RELIABILITY DATA**

Multilayer chip inductors and beads

14. Damp Heat (Steady state)	
BK0402	
BK0603	
BK1005	
BKH1005	
BK1608	
BK2125	Appearance : No significant abnormality. Impedance change : Within $\pm 30\%$
ARRAY	BK2010 BK3216
BKP0603	
BKP1005	
BKP1608	
BKP2125	
CK1608	No mechanical damage.
CK2125	Inductance change : Within $\pm 20\%$ Q change : Within $\pm 30\%$
CKS2125	Inductance change : Within $\pm 20\%$
CKP2012	
CKP2016	
CKP2520	No mechanical damage. Inductance change : Within $\pm 30\%$
NM2012	
NM2520	
LK1005	No mechanical damage.
LK1608	Inductance change : Within $\pm 10\%$ Q change : Within $\pm 30\%$
LK2125	No mechanical damage. Inductance change : Within $\pm 20\%$ Q change : Within $\pm 30\%$
HK0402	
HK0603	
HK1005	
HK1608	No mechanical damage.
HK2125	Inductance change : Within $\pm 10\%$ Q change : Within $\pm 20\%$
HKQ0603S	
HKQ0603U	
AQ105	

**[Test Methods and Remarks]**

BK, BKP, BKH Series :

Temperature :  $40 \pm 2^\circ\text{C}$

Humidity : 90 to 95%RH

Duration :  $500^{+24}_{-0}$  hrs

Recovery : 2 to 3 hrs of recovery under the standard condition after the removal from test chamber.(See Note 1)

LK, CK, CKS, CKP, NM, HK, HKQ, AQ Series :

Temperature :  $40 \pm 2^\circ\text{C}$  (LK, CK, CKS, CKP, NM Series)

:  $60 \pm 2^\circ\text{C}$  (HK, HKQ, AQ Series)

Humidity : 90 to 95%RH

Duration :  $500 \pm 12$  hrs

Recovery : 2 to 3 hrs of recovery under the standard condition after the removal from test chamber.(See Note 1)

\* This catalog contains the typical specification only due to the limitation of space. When you consider the purchase of our products, please check our specification. For details of each product (characteristics graph, reliability information, precautions for use, and so on), see our Web site (<http://www.ty-top.com/>) or CD catalogs.

## RELIABILITY DATA

### Multilayer chip inductors and beads

15. Loading under Damp Heat	
BK0402	
BK0603	
BK1005	
BKH1005	
BK1608	
BK2125	Appearance : No significant abnormality. Impedance change : Within $\pm 30\%$
ARRAY	BK2010 BK3216
BKP0603	
BKP1005	
BKP1608	
BKP2125	
CK1608	No mechanical damage.
CK2125	Inductance change : Within $\pm 20\%$ Q change : Within $\pm 30\%$
CKS2125	No mechanical damage. Inductance change : Within $\pm 20\%$
CKP2012	
CKP2016	
CKP2520	No mechanical damage. Inductance change : Within $\pm 30\%$
NM2012	
NM2520	
LK1005	No mechanical damage. Inductance change : Within $\pm 10\%$ Q change : Within $\pm 30\%$
LK1608	No mechanical damage. Inductance change : 0.047 to 12.0 $\mu$ H : Within $\pm 10\%$ 15.0 to 33.0 $\mu$ H : Within $\pm 15\%$ Q change : Within $\pm 30\%$
LK2125	No mechanical damage. Inductance change : Within $\pm 20\%$ Q change : Within $\pm 30\%$
HK0402	
HK0603	
HK1005	
HK1608	No mechanical damage.
HK2125	Inductance change : Within $\pm 10\%$ Q change : Within $\pm 20\%$
HKQ0603S	
HKQ0603U	
AQ105	

#### [Test Methods and Remarks]

##### BK, BKP, BKH Series :

Temperature : 40 $\pm$ 2 $^{\circ}$ C  
 Humidity : 90 to 95%RH  
 Applied current : Rated current  
 Duration : 500 $_{-0}^{+24}$  hrs  
 Recovery : 2 to 3 hrs of recovery under the standard condition after the removal from test chamber. (See Note 1)

##### LK, CK, CKS, CKP, NM, HK, HKQ, AQ Series :

Temperature : 40 $\pm$ 2 $^{\circ}$ C (LK, CK, CKS, CKP, NM Series)  
 : 60 $\pm$ 2 $^{\circ}$ C (HK, HKQ, AQ Series)  
 Humidity : 90 to 95%RH  
 Applied current : Rated current  
 Duration : 500 $\pm$ 12 hrs  
 Recovery : 2 to 3 hrs of recovery under the standard condition after the removal from test chamber. (See Note 1)

Note on standard condition: "standard condition" referred to herein is defined as follows:

5 to 35 $^{\circ}$ C of temperature, 45 to 85% relative humidity, and 86 to 106kPa of air pressure.

When there are questions concerning measurement results:

In order to provide correlation data, the test shall be conducted under condition of 20 $\pm$ 2 $^{\circ}$ C of temperature, 60 to 70% relative humidity, and 86 to 106kPa of air pressure.

Unless otherwise specified, all the tests are conducted under the "standard condition."

(Note 1) Measurement shall be made after 48 $\pm$ 2 hrs of recovery under the standard condition.

\* This catalog contains the typical specification only due to the limitation of space. When you consider the purchase of our products, please check our specification.  
 For details of each product (characteristics graph, reliability information, precautions for use, and so on), see our Web site (<http://www.ty-top.com/>) or CD catalogs.



**RELIABILITY DATA**

Multilayer chip inductors and beads

16. Loading at High Temperature	
BK0402	
BK0603	
BK1005	
BKH1005	
BK1608	
BK2125	Appearance : No significant abnormality Impedance change : Within $\pm 30\%$
ARRAY	BK2010 BK3216
BKP0603	
BKP1005	
BKP1608	
BKP2125	
CK1608	No mechanical damage.
CK2125	Inductance change : Within $\pm 20\%$ Q change : Within $\pm 30\%$
CKS2125	No mechanical damage. Inductance change : Within $\pm 20\%$
CKP2012	
CKP2016	
CKP2520	No mechanical damage. Inductance change : Within $\pm 30\%$
NM2012	
NM2520	
LK1005	No mechanical damage. Inductance change : Within $\pm 10\%$ Q change : Within $\pm 30\%$
LK1608	No mechanical damage. Inductance change : 0.047 to 12.0 $\mu\text{H}$ : Within $\pm 10\%$ 15.0 to 33.0 $\mu\text{H}$ : Within $\pm 15\%$ Q change : Within $\pm 30\%$
LK2125	No mechanical damage. Inductance change : Within $\pm 20\%$ Q change : Within $\pm 30\%$
HK0402	
HK0603	
HK1005	
HK1608	No mechanical damage.
HK2125	Inductance change : Within $\pm 10\%$ Q change : Within $\pm 20\%$
HKQ0603S	
HKQ0603U	
AQ105	

**[Test Methods and Remarks]**

**BK, BKH Series :**

Temperature : 125 $\pm$ 3 $^{\circ}$ C

Applied current : Rated current

Duration : 500 $^{+24}_0$  hrs

Recovery : 2 to 3 hrs of recovery under the standard condition after the removal from test chamber.(See Note 1)

**LK, CK, CKS, CKP, NM, HK, HKQ, AQ, BKP Series :**

Temperature : 85 $\pm$ 2 $^{\circ}$ C (LK, CK, CKS, CKP, NM, BKP Series)

: 85 $\pm$ 2 $^{\circ}$ C (HK1608, 2125)

: 85 $\pm$ 2 $^{\circ}$ C (HK1005, AQ105 operating temperature range -55 to +85 $^{\circ}$ C)

: 125 $\pm$ 2 $^{\circ}$ C (HK0402, HK0603, HK1005, HKQ0603S, HKQ0603U, AQ105 operating temperature range -55 to +125 $^{\circ}$ C)

Applied current : Rated current

Duration : 500 $\pm$ 12 hrs

Recovery : 2 to 3 hrs of recovery under the standard condition after the test.(See Note 1)

Note on standard condition: "standard condition" referred to herein is defined as follows:

5 to 35 $^{\circ}$ C of temperature, 45 to 85% relative humidity, and 86 to 106kPa of air pressure.

When there are questions concerning measurement results:

In order to provide correlation data, the test shall be conducted under condition of 20 $\pm$ 2 $^{\circ}$ C of temperature, 60 to 70% relative humidity, and 86 to 106kPa of air pressure. Unless otherwise specified, all the tests are conducted under the "standard condition."

(Note 1) Measurement shall be made after 48 $\pm$ 2 hrs of recovery under the standard condition.

\* This catalog contains the typical specification only due to the limitation of space. When you consider the purchase of our products, please check our specification. For details of each product (characteristics graph, reliability information, precautions for use, and so on), see our Web site (<http://www.ty-top.com/>) or CD catalogs.

## PRECAUTIONS

Precautions on the use of Multilayer chip Inductors, Multilayer chip inductors for high frequency, Multilayer chip bead Inductors

### 1. Circuit Design

Precautions	<p>◆Verification of operating environment, electrical rating and performance</p> <p>1. A malfunction in medical equipment, spacecraft, nuclear reactors, etc. may cause serious harm to human life or have severe social ramifications. As such, any inductors to be used in such equipment may require higher safety and/or reliability considerations and should be clearly differentiated from components used in general purpose applications.</p>
	<p>◆Operating Current (Verification of Rated current)</p> <p>1. The operating current for inductors must always be lower than their rated values.</p> <p>2. Do not apply current in excess of the rated value because the inductance may be reduced due to the magnetic saturation effect.</p>

### 2. PCB Design

Precautions	<p>◆Pattern configurations(Design of Land-patterns)</p> <p>1. When inductors are mounted on a PCB, the size of land patterns and the amount of solder used(size of fillet) can directly affect inductor performance. Therefore, the following items must be carefully considered in the design of solder land patterns:</p> <p>(1) The amount of solder applied can affect the ability of chips to withstand mechanical stresses which may lead to breaking or cracking. Therefore, when designing land-patterns it is necessary to consider the appropriate size and configuration of the solder pads which in turn determines the amount of solder necessary to form the fillets.</p> <p>(2) When more than one part is jointly soldered onto the same land or pad, the pad must be designed so that each component's soldering point is separated by solder-resist.</p> <p>(3) The larger size of land patterns and amount of solder, the smaller Q value after mounting on PCB. It makes higher the Q value to design land patterns smaller than terminal electrode of chips.</p>
	<p>◆Pattern configurations(Inductor layout on panelized [breakaway] PC boards)</p> <p>1. After inductors have been mounted on the boards, chips can be subjected to mechanical stresses in subsequent manufacturing processes (PCB cutting, board inspection, mounting of additional parts, assembly into the chassis, wave soldering the reflow soldered boards etc.) For this reason, planning pattern configurations and the position of SMD inductors should be carefully performed to minimize stress.</p>

◆Pattern configurations(Design of Land-patterns)

1. The following diagrams and tables show some examples of recommended patterns to prevent excessive solder amounts (larger fillets which extend above the component end terminations). Examples of improper pattern designs are also shown.

(1) Recommended land dimensions for a typical chip inductor land patterns for PCBs

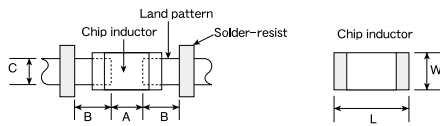

Recommended land dimensions for wave-soldering

Type	1608	2125	3216	
Solder-resist	L	1.6	2.0	3.2
	W	0.8	1.25	1.6
A	0.8~1.0	1.0~1.4	1.8~2.5	
B	0.5~0.8	0.8~1.5	0.8~1.7	
C	0.6~0.8	0.9~1.2	1.2~1.6	

(Unit : mm)

Recommended land dimensions for reflow-soldering

Type	0402	0603	1005	105	1608	2012	2125	2016	3216	2520
Solder-resist	L	0.4	0.6	1.0	1.0	1.6	2.0	2.0	3.2	2.5
	W	0.2	0.3	0.5	0.6	0.8	1.25	1.25	1.6	2.0
A	0.15~0.25	0.20~0.30	0.45~0.55	0.50~0.55	0.8~1.0	0.8~1.2	0.8~1.2	0.8~1.2	1.8~2.5	1.0~1.4
B	0.10~0.20	0.20~0.30	0.40~0.50	0.30~0.40	0.6~0.8	0.8~1.2	0.8~1.2	0.8~1.2	0.6~1.5	0.6~1.0
C	0.15~0.30	0.25~0.40	0.45~0.55	0.60~0.70	0.6~0.8	0.9~1.6	0.9~1.6	1.2~2.0	1.8~2.2	1.8~2.2

(Unit : mm)

Excess solder can affect the ability of chips to withstand mechanical stresses. Therefore, please take proper precautions when designing land-patterns.

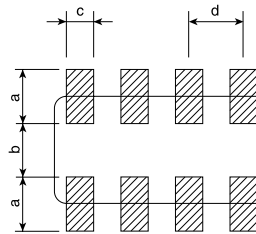

Technical considerations

Recommended land dimension for Reflow-soldering

Type	3216	2010	
Solder-resist	L	3.2	2.0
	W	1.6	1.0
a	0.7~0.9	0.5~0.6	
b	0.8~1.0	0.5~0.6	
c	0.4~0.5	0.2~0.3	
d	0.8	0.5	

(Unit : mm)

(2) Examples of good and bad solder application

Item	Not recommended	Recommended
Mixed mounting of SMD and leaded components		
Component placement close to the chassis		
Hand-soldering of leaded components near mounted components		
Horizontal component placement		

To next page

\* This catalog contains the typical specification only due to the limitation of space. When you consider the purchase of our products, please check our specification. For details of each product (characteristics graph, reliability information, precautions for use, and so on), see our Web site (<http://www.ty-top.com/>) or CD catalogs.

## PRECAUTIONS

### Precautions on the use of Multilayer chip Inductors, Multilayer chip inductors for high frequency, Multilayer chip bead Inductors

#### 2. PCB Design

##### ◆Pattern configurations (Inductor layout on panelized [breakaway] PC boards)

- 1-1. The following are examples of good and bad inductor layout; SMD inductors should be located to minimize any possible mechanical stresses from board warp or deflection.

Item	Not recommended	Recommended
Deflection of the board		Position the component at a right angle to the direction of the mechanical stresses that are anticipated.

Technical considerations

- 1-2. To layout the inductors for the breakaway PC board, it should be noted that the amount of mechanical stresses given will vary depending on inductor layout. An example below should be counted for better design.

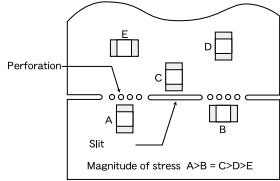

- 1-3. When breaking PC boards along their perforations, the amount of mechanical stress on the inductors can vary according to the method used. The following methods are listed in order from least stressful to most stressful: push-back, slit, V-grooving, and perforation. Thus, any ideal SMD inductor layout must also consider the PCB splitting procedure.

#### 3. Considerations for automatic placement

##### ◆Adjustment of mounting machine

- Excessive impact load should not be imposed on the inductors when mounting onto the PC boards.
- The maintenance and inspection of the moulder should be conducted periodically.

Precautions

##### ◆Selection of Adhesives

- Mounting inductors with adhesives in preliminary assembly, before the soldering stage, may lead to degraded inductor characteristics unless the following factors are appropriately checked; the size of land patterns, type of adhesive, amount applied, hardening temperature and hardening period. Therefore, it is imperative to consult the manufacturer of the adhesives on proper usage and amounts of adhesive to use.

##### ◆Adjustment of mounting machine

- If the lower limit of the pick-up nozzle is low, too much force may be imposed on the inductors, causing damage. To avoid this, the following points should be considered before lowering the pick-up nozzle:
  - The lower limit of the pick-up nozzle should be adjusted to the surface level of the PC board after correcting for deflection of the board.
  - The pick-up pressure should be adjusted between 1 and 3N static loads.
  - To reduce the amount of deflection of the board caused by impact of the pick-up nozzle, supporting pins or back-up pins should be used under the PC board. The following diagrams show some typical examples of good pick-up nozzle placement:

Item	Improper method	Proper method
Single-sided mounting	chipping or cracking	supporting pins or back-up pins
Double-sided mounting	chipping or cracking	supporting pins

- As the alignment pin wears out, adjustment of the nozzle height can cause chipping or cracking of the inductors because of mechanical impact on the inductors. To avoid this, the monitoring of the width between the alignment pin in the stopped position, and maintenance, inspection and replacement of the pin should be conducted periodically.

Technical considerations

##### ◆Selection of Adhesives

- Some adhesives may cause reduced insulation resistance. The difference between the shrinkage percentage of the adhesive and that of the inductors may result in stresses on the inductors and lead to cracking. Moreover, too little or too much adhesive applied to the board may adversely affect component placement, so the following precautions should be noted in the application of adhesives.

###### (1) Required adhesive characteristics

- The adhesive should be strong enough to hold parts on the board during the mounting & solder process.
- The adhesive should have sufficient strength at high temperatures.
- The adhesive should have good coating and thickness consistency.
- The adhesive should be used during its prescribed shelf life.
- The adhesive should harden rapidly.
- The adhesive must not be contaminated.
- The adhesive should have excellent insulation characteristics.
- The adhesive should not be toxic and have no emission of toxic gasses.

- When using adhesives to mount inductors on a PCB, inappropriate amounts of adhesive on the board may adversely affect component placement. Too little adhesive may cause the inductors to fall off the board during the solder process. Too much adhesive may cause defective soldering due excessive flow of adhesive on to the land or solder pad.

###### [Recommended conditions]

Figure	0805 case sizes as examples
a	0.3mm min
b	100~120 μm
c	Area with no adhesive

\* This catalog contains the typical specification only due to the limitation of space. When you consider the purchase of our products, please check our specification. For details of each product (characteristics graph, reliability information, precautions for use, and so on), see our Web site (<http://www.ty-top.com/>) or CD catalogs.

# PRECAUTIONS

## Precautions on the use of Multilayer chip Inductors, Multilayer chip inductors for high frequency, Multilayer chip bead Inductors

### 4. Soldering

**◆Selection of Flux**  
 1. Since flux may have a significant effect on the performance of inductors, it is necessary to verify the following conditions prior to use;  
 (1) Flux used should be with less than or equal to 0.1 wt% (Chlorine conversion method) of halogenated content. Flux having a strong acidity content should not be applied.  
 (2) When soldering inductors on the board, the amount of flux applied should be controlled at the optimum level.  
 (3) When using water-soluble flux, special care should be taken to properly clean the boards.

**◆Soldering**  
 1. Temperature, time, amount of solder, etc. are specified in accordance with the following recommended conditions, and please contact us about peak temperature when you use lead-free paste.

**◆Selection of Flux**  
 1-1. When too much halogenated substance (Chlorine, etc.) content is used to activate the flux, or highly acidic flux is used, an excessive amount of residue after soldering may lead to corrosion of the terminal electrodes or degradation of insulation resistance on the surface of the Inductor.  
 1-2. Flux is used to increase solderability in flow soldering, but if too much is applied, a large amount of flux gas may be emitted and may detrimentally affect solderability. To minimize the amount of flux applied, it is recommended to use a flux-bubbling system.  
 1-3. Since the residue of water-soluble flux is easily dissolved by water content in the air, the residue on the surface of Inductor in high humidity conditions may cause a degradation of insulation resistance and therefore affect the reliability of the components. The cleaning methods and the capability of the machines used should also be considered carefully when selecting water-soluble flux.

**◆Soldering**  
 1-1. Preheating when soldering  
 Heating: Chip inductor components should be preheated to within 100 to 130°C of the soldering. Cooling: The temperature difference between the components and cleaning process should not be greater than 100°C.  
 Chip inductors are susceptible to thermal shock when exposed to rapid or concentrated heating or rapid cooling. Therefore, the soldering process must be conducted with a great care so as to prevent malfunction of the components due to excessive thermal shock.

#### Recommended conditions for soldering

[Reflow soldering]  
 Temperature profile

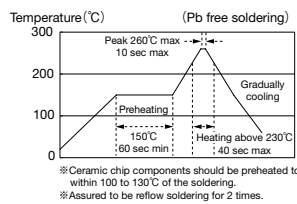
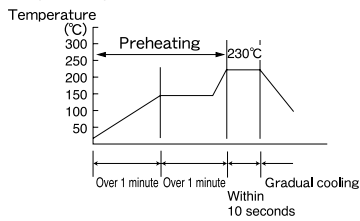

#### Caution

1. The ideal condition is to have solder mass (fillet) controlled to 1/2 to 1/3 of the thickness of the inductor, as shown below:

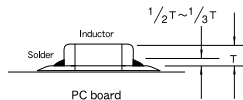

2. Because excessive dwell times can detrimentally affect solderability, soldering duration should be kept as close to recommended times as possible.

[Wave soldering]  
 Temperature profile

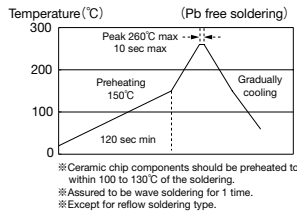
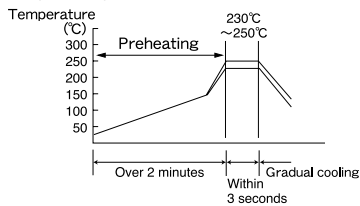

#### Caution

1. Make sure the inductors are preheated sufficiently.
2. The temperature difference between the inductor and melted solder should not be greater than 100 to 130°C.
3. Cooling after soldering should be as gradual as possible.
4. Wave soldering must not be applied to the inductors designated as for reflow soldering only.

[Hand soldering]  
 Temperature profile

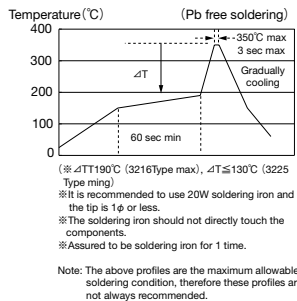
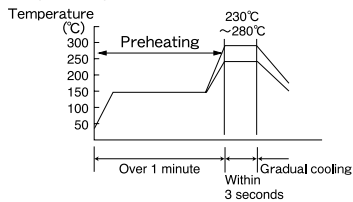

#### Caution

1. Use a 20W soldering iron with a maximum tip diameter of 1.0 mm.
2. The soldering iron should not directly touch the inductor.

Technical considerations

\* This catalog contains the typical specification only due to the limitation of space. When you consider the purchase of our products, please check our specification. For details of each product (characteristics graph, reliability information, precautions for use, and so on), see our Web site (<http://www.ty-top.com/>) or CD catalogs.

## PRECAUTIONS

### Precautions on the use of Multilayer chip Inductors, Multilayer chip inductors for high frequency, Multilayer chip bead Inductors

5. Cleaning							
Precautions	<ul style="list-style-type: none"> <li>◆Cleaning conditions</li> <li>1. When cleaning the PC board after the Inductors are all mounted, select the appropriate cleaning solution according to the type of flux used and purpose of the cleaning (e.g. to remove soldering flux or other materials from the production process.)</li> <li>2. Cleaning conditions should be determined after verifying, through a test run, that the cleaning process does not affect the inductor's characteristics.</li> </ul>						
Technical considerations	<ul style="list-style-type: none"> <li>◆Cleaning conditions</li> <li>1. The use of inappropriate solutions can cause foreign substances such as flux residue to adhere to the inductor, resulting in a degradation of the inductor's electrical properties (especially insulation resistance).</li> <li>2. Inappropriate cleaning conditions (insufficient or excessive cleaning) may detrimentally affect the performance of the inductors.               <ul style="list-style-type: none"> <li>(1) Excessive cleaning                   <ul style="list-style-type: none"> <li>a. In the case of ultrasonic cleaning, too much power output can cause excessive vibration of the PC board which may lead to the cracking of the inductor or the soldered portion, or decrease the terminal electrodes' strength. Thus the following conditions should be carefully checked;                       <table border="0" style="margin-left: 20px;"> <tr> <td>Ultrasonic output</td> <td>Below 20W/ℓ</td> </tr> <tr> <td>Ultrasonic frequency</td> <td>Below 40kHz</td> </tr> <tr> <td>Ultrasonic washing period</td> <td>5 min. or less</td> </tr> </table> </li> </ul> </li> </ul> </li> </ul>	Ultrasonic output	Below 20W/ℓ	Ultrasonic frequency	Below 40kHz	Ultrasonic washing period	5 min. or less
Ultrasonic output	Below 20W/ℓ						
Ultrasonic frequency	Below 40kHz						
Ultrasonic washing period	5 min. or less						
6. Post cleaning processes							
Precautions	<ul style="list-style-type: none"> <li>◆Application of resin coatings, moldings, etc. to the PCB and components.               <ul style="list-style-type: none"> <li>1. With some type of resins a decomposition gas or chemical reaction vapor may remain inside the resin during the hardening period or while left under normal storage conditions resulting in the deterioration of the inductor's performance.</li> <li>2. When a resin's hardening temperature is higher than the inductor's operating temperature, the stresses generated by the excess heat may lead to inductor damage or destruction.</li> <li>3. Stress caused by a resin's temperature generated expansion and contraction may damage inductors.</li> </ul> </li> </ul> <p>The use of such resins, molding materials etc. is not recommended.</p>						
7. Handling							
Precautions	<ul style="list-style-type: none"> <li>◆Breakaway PC boards (splitting along perforations)               <ul style="list-style-type: none"> <li>1. When splitting the PC board after mounting inductors and other components, care is required so as not to give any stresses of deflection or twisting to the board.</li> <li>2. Board separation should not be done manually, but by using the appropriate devices.</li> </ul> </li> <li>◆General handling precautions               <ul style="list-style-type: none"> <li>1. Always wear static control bands to protect against ESD.</li> <li>2. Keep the inductors away from all magnets and magnetic objects.</li> <li>3. Use non-magnetic tweezers when handling inductors.</li> <li>4. Any devices used with the inductors (soldering irons, measuring instruments) should be properly grounded.</li> <li>5. Keep bare hands and metal products (i.e., metal desk) away from chip electrodes or conductive areas that lead to chip electrodes.</li> <li>6. Keep inductors away from items that generate magnetic fields such as speakers or coils.</li> </ul> </li> <li>◆Mechanical considerations               <ul style="list-style-type: none"> <li>1. Be careful not to subject the inductors to excessive mechanical shocks.                   <ul style="list-style-type: none"> <li>(1) If inductors are dropped on the floor or a hard surface they should not be used.</li> <li>(2) When handling the mounted boards, be careful that the mounted components do not come in contact with or bump against other boards or components.</li> </ul> </li> </ul> </li> </ul>						
8. Storage conditions							
Precautions	<ul style="list-style-type: none"> <li>◆Storage               <ul style="list-style-type: none"> <li>1. To maintain the solderability of terminal electrodes and to keep the packaging material in good condition, care must be taken to control temperature and humidity in the storage area. Humidity should especially be kept as low as possible.                   <table border="0" style="margin-left: 20px; width: 100%;"> <tr> <td colspan="2">Recommended conditions</td> </tr> <tr> <td>Ambient temperature</td> <td>Below 40°C</td> </tr> <tr> <td>Humidity</td> <td>Below 70% RH</td> </tr> </table> </li> </ul> <p>The ambient temperature must be kept below 30°C. Even under ideal storage conditions inductor electrode solderability decreases as time passes, so inductors should be used within 6 months from the time of delivery.</p> <p>*The packaging material should be kept where no chlorine or sulfur exists in the air.</p> </li> </ul>	Recommended conditions		Ambient temperature	Below 40°C	Humidity	Below 70% RH
Recommended conditions							
Ambient temperature	Below 40°C						
Humidity	Below 70% RH						
Technical considerations	<ul style="list-style-type: none"> <li>◆Storage               <ul style="list-style-type: none"> <li>1. If the parts are stocked in a high temperature and humidity environment, problems such as reduced solderability caused by oxidation of terminal electrodes and deterioration of taping/package materials may take place. For this reason, components should be used within 6 months from the time of delivery. If exceeding the above period, please check solderability before using the inductors.</li> </ul> </li> </ul>						

\* This catalog contains the typical specification only due to the limitation of space. When you consider the purchase of our products, please check our specification. For details of each product (characteristics graph, reliability information, precautions for use, and so on), see our Web site (<http://www.ty-top.com/>) or CD catalogs.