



M24C32-DF M24C32-W M24C32-R M24C32-F

32 Kbit serial I²C bus EEPROM

Features

- Compatible with all I²C bus modes:
 - 1 MHz Fast-mode Plus
 - 400 kHz Fast mode
 - 100 kHz Standard mode
- Memory array:
 - 32 Kb (4 Kbytes) of EEPROM
 - Page size: 32 bytes
- M24C32-DF: additional Write lockable Page (Identification page)
- Write
 - Byte Write within 5 ms
 - Page Write within 5 ms
- Random and Sequential Read modes
- Write protect of the whole memory array
- Single supply voltage:
 - M24C32-W: 2.5 V to 5.5 V
 - M24C32-R: 1.8 V to 5.5 V
 - M24C32-xF: 1.7 V to 5.5 V
- Enhanced ESD/Latch-Up protection
- More than 1 million Write cycles
- More than 40-year data retention
- Packages
 - ECOPACK2® (RoHS-compliant and halogen-free)
 - PDIP8 package: ECOPACK1® (RoHS-compliant)

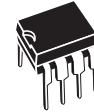

PDIP8 (BN)



SO8 (MN)
150 mil width



TSSOP8 (DW)
169 mil width



UFDFPN8
(MB, MC)

Contents

1	Description	6
2	Signal description	8
2.1	Serial Clock (SCL)	8
2.2	Serial Data (SDA)	8
2.3	Chip Enable (E2, E1, E0)	8
2.4	Write Control (\overline{WC})	8
2.5	V_{SS} ground	9
2.6	Supply voltage (V_{CC})	9
2.6.1	Operating supply voltage V_{CC}	9
2.6.2	Power-up conditions	9
2.6.3	Device reset	9
2.6.4	Power-down conditions	9
3	Memory organization	12
4	Device operation	13
4.1	Start condition	13
4.2	Stop condition	13
4.3	Acknowledge bit (ACK)	13
4.4	Data Input	13
4.5	Memory addressing	14
4.6	Write operations	16
4.7	Byte Write	16
4.8	Page Write	16
4.9	Write Identification Page (M24C32-D only)	17
4.10	Lock Identification Page (M24C32-D only)	18
4.11	ECC (Error Correction Code) and Write cycling	18
4.12	Minimizing system delays by polling on ACK	19
4.13	Read operations	21
4.14	Random Address Read	21
4.15	Current Address Read	21

4.16	Sequential Read	21
4.17	Read Identification Page (M24C32-D)	21
4.18	Read the lock status (M24C32-D)	22
4.19	Acknowledge in Read mode	22
5	Initial delivery state	23
6	Maximum rating	23
7	DC and AC parameters	24
8	Package mechanical data	33
9	Part numbering	37
10	Revision history	38

List of tables

Table 1.	Signal names	7
Table 2.	Address most significant byte	11
Table 3.	Address least significant byte	11
Table 4.	Device select code	14
Table 5.	Operating modes	14
Table 6.	Absolute maximum ratings	23
Table 7.	Operating conditions (M24xxx-W)	24
Table 8.	Operating conditions (M24xxx-R)	24
Table 9.	Operating conditions (M24xxx-F)	24
Table 10.	AC test measurement conditions	24
Table 11.	Input parameters	25
Table 12.	Memory cell characteristics	25
Table 13.	DC characteristics (M24xxx-W, device grade 6)	26
Table 14.	DC characteristics (M24xxx-W - device grade 3)	27
Table 15.	DC characteristics (M24xxx-R - device grade 6)	28
Table 16.	DC characteristics (M24xxx-F)	29
Table 17.	400 kHz AC characteristics	30
Table 18.	1 MHz AC characteristics	31
Table 19.	PDIP8 – 8 pin plastic DIP, 0.25 mm lead frame, package mechanical data	33
Table 20.	SO8 narrow – 8 lead plastic small outline, 150 mils body width, package mechanical data	34
Table 21.	TSSOP8 – 8 lead thin shrink small outline, package mechanical data	35
Table 22.	UFDFPN8 (MLP8) 8-lead ultra thin fine pitch dual flat package no lead 2 x 3 mm, data	36
Table 23.	Ordering information scheme	37
Table 24.	Document revision history	38

List of figures

Figure 1.	Logic diagram	6
Figure 2.	8-pin package connections	7
Figure 3.	Device select code	8
Figure 4.	I ² C Fast mode ($f_C = 400$ kHz): maximum R_{bus} value versus bus parasitic capacitance (C_{bus})	10
Figure 5.	I ² C Fast mode Plus ($f_C = 1$ MHz): maximum R_{bus} value versus bus parasitic capacitance (C_{bus})	10
Figure 6.	I ² C bus protocol	11
Figure 7.	Block diagram	12
Figure 8.	Write mode sequences with $\overline{WC} = 1$ (data write inhibited)	15
Figure 9.	Write mode sequences with $\overline{WC} = 0$ (data write enabled)	17
Figure 10.	Write cycle polling flowchart using ACK	19
Figure 11.	Read mode sequences	20
Figure 12.	AC test measurement I/O waveform	24
Figure 13.	AC waveforms	32
Figure 14.	PDIP8 – 8 pin plastic DIP, 0.25 mm lead frame, package outline	33
Figure 15.	SO8 narrow – 8 lead plastic small outline, 150 mils body width, package outline	34
Figure 16.	TSSOP8 – 8 lead thin shrink small outline, package outline	35
Figure 17.	UFDFPN8 (MLP8) – 8-lead ultra thin fine pitch dual flat package no lead 2 × 3mm, package outline	36

1 Description

M24C32-x devices are I²C-compatible EEPROM (electrically erasable programmable memories) organized as 4096 × 8 bits.

The M24C32-W operates with a supply voltage range of 2.5 V/5.5 V, the M24C32-R with a supply voltage range of 1.8 V/5.5 V and the M24C32-F and M24C32-DF with a supply voltage range of 1.7 V/5.5 V.

The M24C32-DF offers an additional page, named the Identification Page (32 bytes) which can be written and (later) permanently locked in Read-only mode. This Identification Page offers flexibility in the application board production line, as it can be used to store unique identification parameters and/or parameters specific to the production line.

Figure 1. Logic diagram

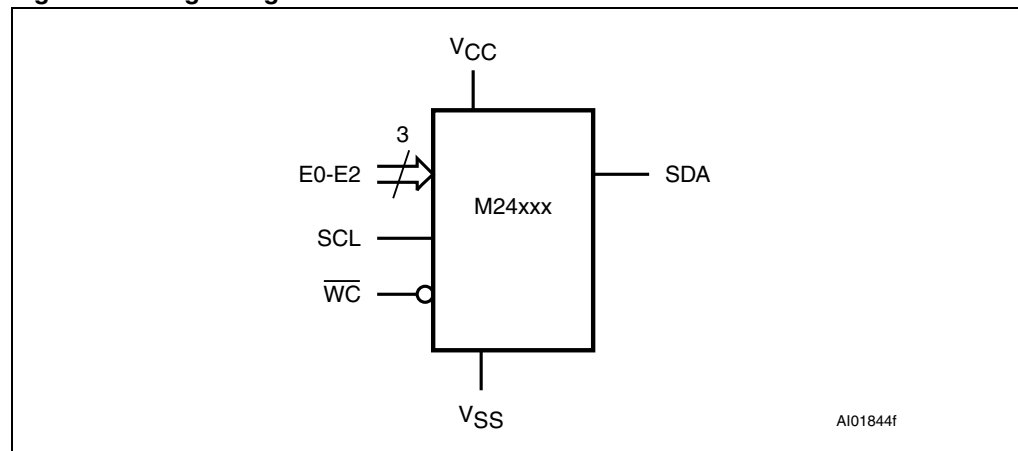
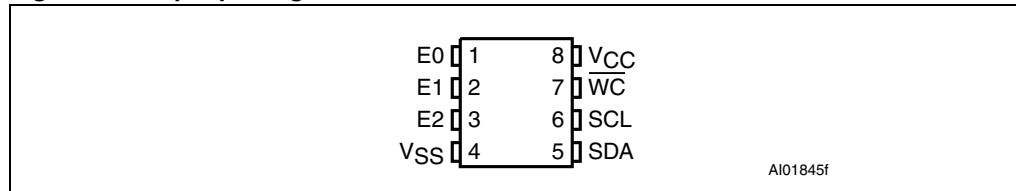

Table 1. Signal names

Signal name	Function	Direction
E2, E1, E0	Chip Enable	Input
SDA	Serial Data	I/O
SCL	Serial Clock	Input
WC	Write Control	Input
V _{CC}	Supply voltage	
V _{SS}	Ground	

Figure 2. 8-pin package connections

1. See [Package mechanical data](#) section for package dimensions, and how to identify pin-1.

2 Signal description

2.1 Serial Clock (SCL)

This input signal is used to strobe all data in and out of the device. In applications where this signal is used by slave devices to synchronize the bus to a slower clock, the bus master must have an open drain output, and a pull-up resistor must be connected from Serial Clock (SCL) to V_{CC} . (Figure 4 indicates how the value of the pull-up resistor can be calculated). In most applications, though, this method of synchronization is not employed, and so the pull-up resistor is not necessary, provided that the bus master has a push-pull (rather than open drain) output.

2.2 Serial Data (SDA)

This bidirectional signal is used to transfer data in or out of the device. It is an open drain output that may be wire-OR'ed with other open drain or open collector signals on the bus. A pull up resistor must be connected from Serial Data (SDA) to V_{CC} . (Figure 4 indicates how the value of the pull-up resistor can be calculated).

2.3 Chip Enable (E2, E1, E0)

(E2,E1,E0) input signals are used to set the value that is to be looked for on the three least significant bits (b3, b2, b1) of the 7-bit device select code. These inputs must be tied to V_{CC} or V_{SS} , to establish the device select code as shown in Figure 3. When not connected (left floating), these inputs are read as low (0).

Figure 3. Device select code

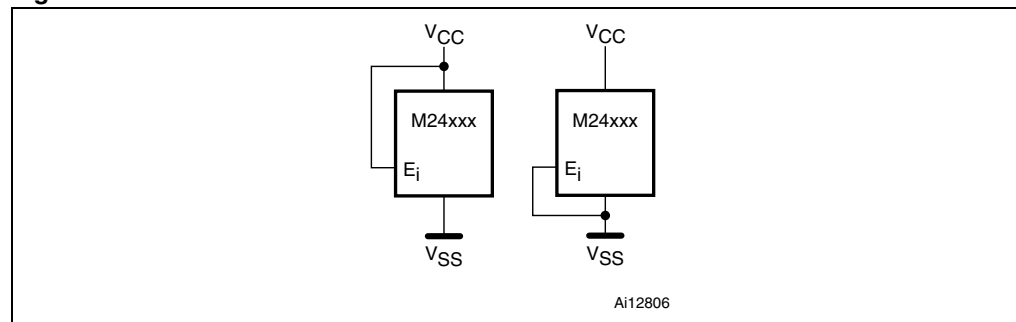

2.4 Write Control (\overline{WC})

This input signal is useful for protecting the entire contents of the memory from inadvertent write operations. Write operations are disabled to the entire memory array when Write Control (\overline{WC}) is driven high. When unconnected, the signal is internally read as V_{IL} , and Write operations are allowed.

When Write Control (\overline{WC}) is driven high, device select and Address bytes are acknowledged, Data bytes are not acknowledged.

2.5 V_{SS} ground

V_{SS} is the reference for the V_{CC} supply voltage.

2.6 Supply voltage (V_{CC})

2.6.1 Operating supply voltage V_{CC}

Prior to selecting the memory and issuing instructions to it, a valid and stable V_{CC} voltage within the specified [$V_{CC}(\min)$, $V_{CC}(\max)$] range must be applied (see [Table 7](#), [Table 8](#) and [Table 9](#)). In order to secure a stable DC supply voltage, it is recommended to decouple the V_{CC} line with a suitable capacitor (usually of the order of 10 nF to 100 nF) close to the V_{CC}/V_{SS} package pins.

This voltage must remain stable and valid until the end of the transmission of the instruction and, for a Write instruction, until the completion of the internal write cycle (t_W).

2.6.2 Power-up conditions

The V_{CC} voltage has to rise continuously from 0 V up to the minimum V_{CC} operating voltage defined in [Table 7](#), [Table 8](#) and [Table 9](#). The rise time must not vary faster than 1 V/ μ s.

2.6.3 Device reset

In order to prevent inadvertent Write operations during power-up, a power on reset (POR) circuit is included. At power-up (continuous rise of V_{CC}), the device does not respond to any instruction until V_{CC} has reached the power on reset threshold voltage (this threshold is lower than the minimum V_{CC} operating voltage defined in [Table 8](#) and [Table 9](#)). Until V_{CC} passes over the POR threshold, the device is reset and in Standby Power mode.

In a similar way, during power-down (continuous decay of V_{CC}), as soon as V_{CC} drops below the POR threshold voltage, the device is reset and stops responding to any instruction sent to it.

2.6.4 Power-down conditions

During power-down (continuous decay of V_{CC}), the device must be in Standby Power mode (mode reached after decoding a Stop condition, assuming that there is no internal Write cycle in progress).

Figure 4. I²C Fast mode (f_C = 400 kHz): maximum R_{bus} value versus bus parasitic capacitance (C_{bus})

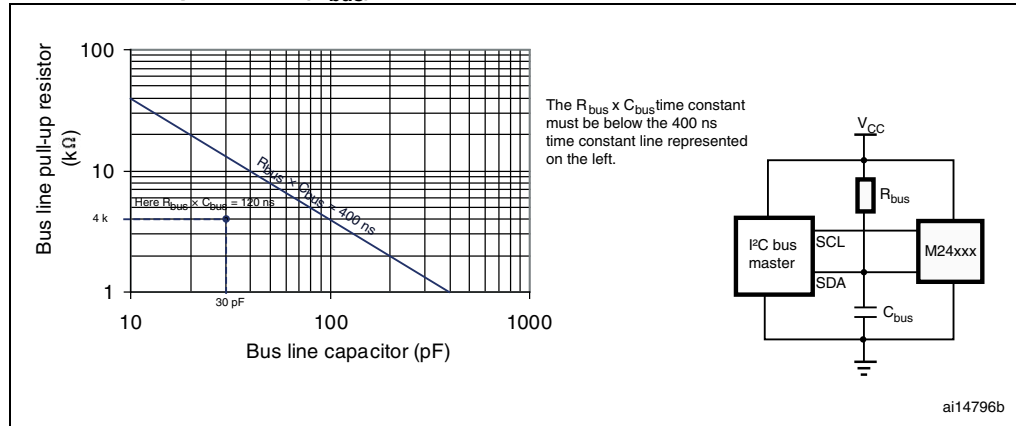

Figure 5. I²C Fast mode Plus (f_C = 1 MHz): maximum R_{bus} value versus bus parasitic capacitance (C_{bus})

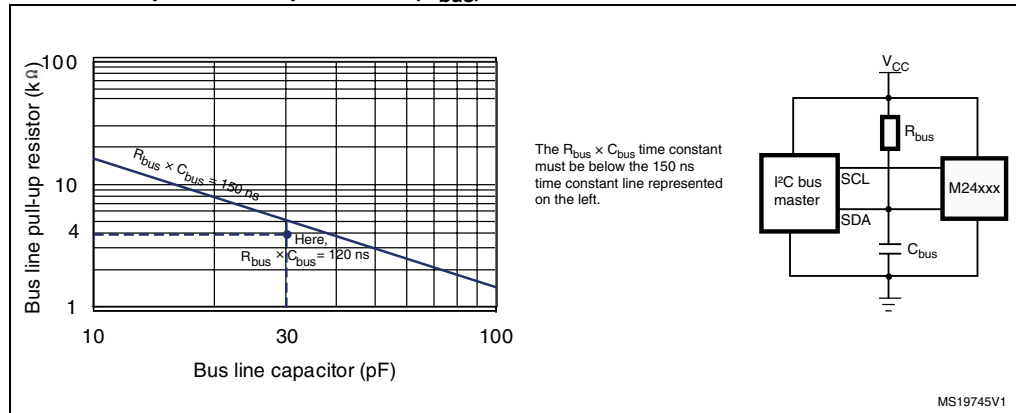

Figure 6. I²C bus protocol

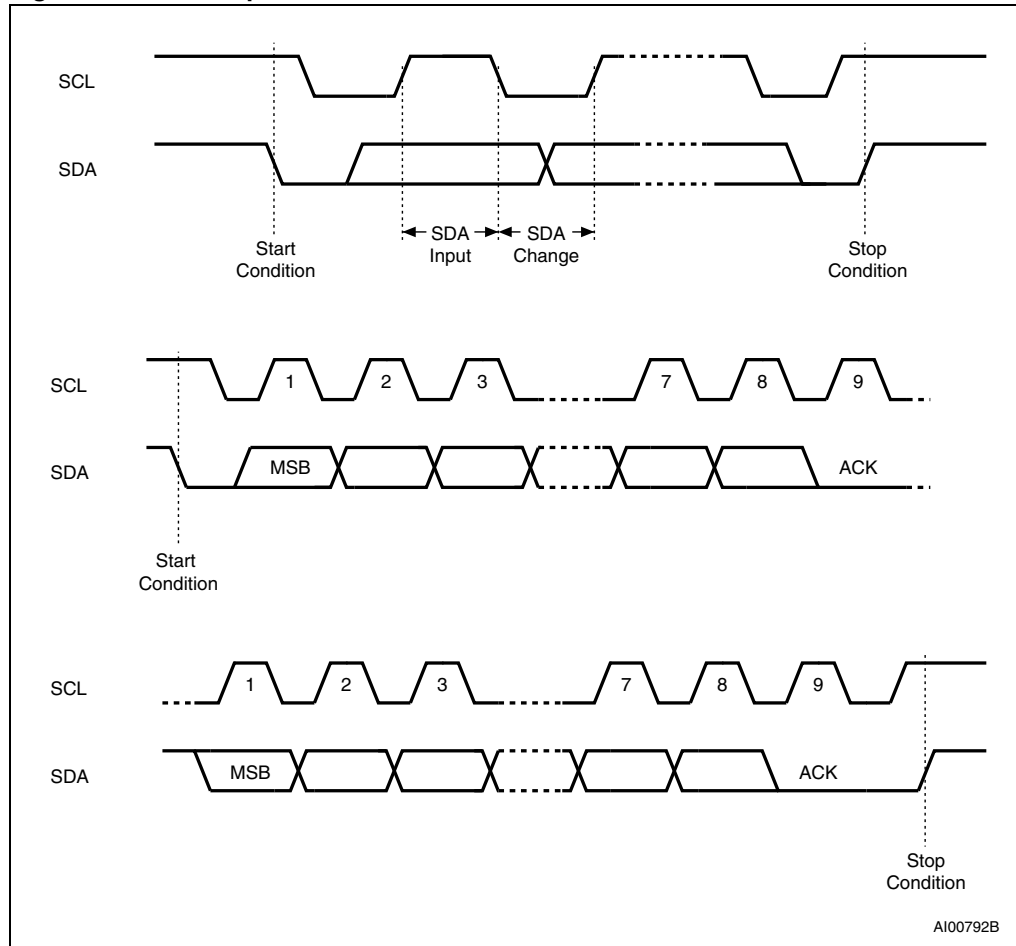

Table 2. Address most significant byte

b15	b14	b13	b12	b11	b10	b9	b8
-----	-----	-----	-----	-----	-----	----	----

Table 3. Address least significant byte

b7	b6	b5	b4	b3	b2	b1	b0
----	----	----	----	----	----	----	----

3 Memory organization

The memory is organized as shown in [Figure 7](#).

Figure 7. Block diagram

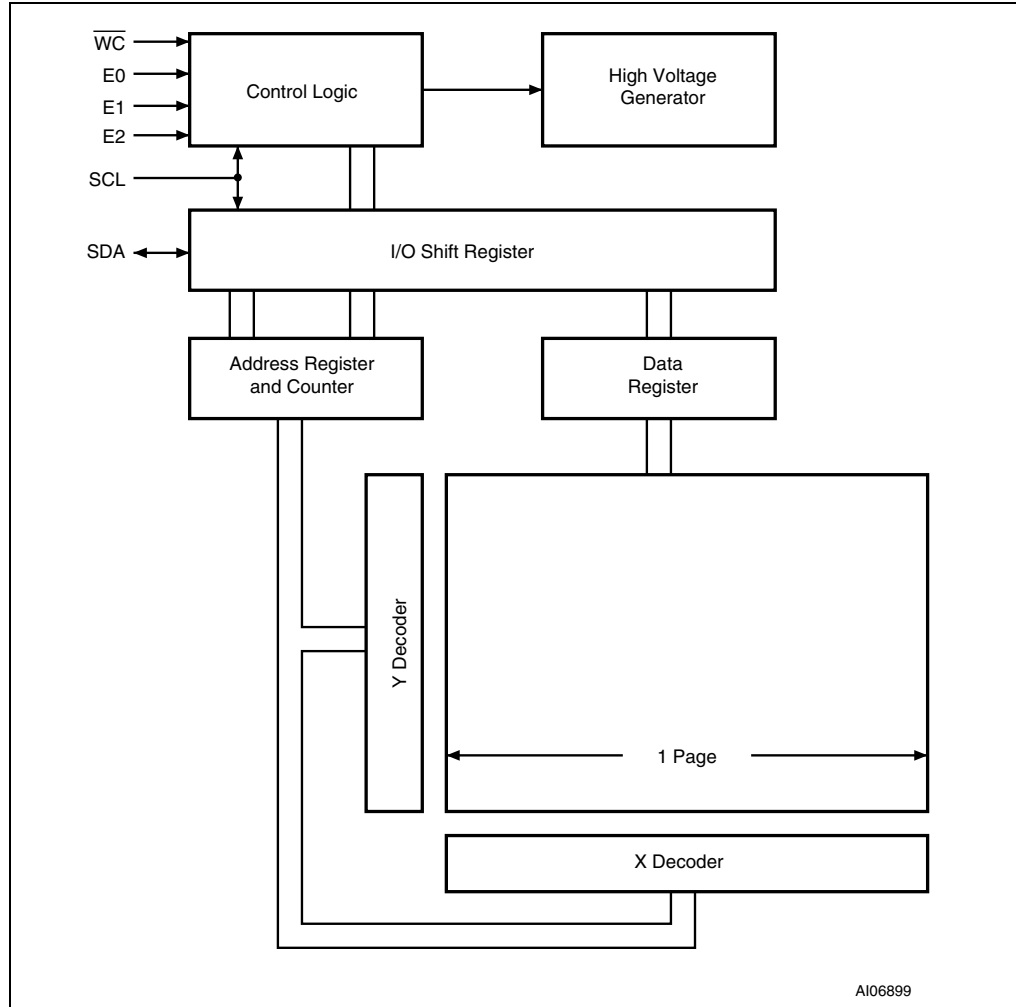

4 Device operation

The device supports the I²C protocol. This is summarized in [Figure 6](#). Any device that sends data on to the bus is defined to be a transmitter, and any device that reads the data to be a receiver. The device that controls the data transfer is known as the bus master, and the other as the slave device. A data transfer can only be initiated by the bus master, which will also provide the serial clock for synchronization. The device is always a slave in all communications.

4.1 Start condition

Start is identified by a falling edge of Serial Data (SDA) while Serial Clock (SCL) is stable in the high state. A Start condition must precede any data transfer command. The device continuously monitors (except during a Write cycle) Serial Data (SDA) and Serial Clock (SCL) for a Start condition.

4.2 Stop condition

Stop is identified by a rising edge of Serial Data (SDA) while Serial Clock (SCL) is stable and driven high. A Stop condition terminates communication between the device and the bus master. A Read command that is followed by NoAck can be followed by a Stop condition to force the device into the Standby mode. A Stop condition at the end of a Write command triggers the internal Write cycle.

4.3 Acknowledge bit (ACK)

The acknowledge bit is used to indicate a successful byte transfer. The bus transmitter, whether it be bus master or slave device, releases Serial Data (SDA) after sending eight bits of data. During the 9th clock pulse period, the receiver pulls Serial Data (SDA) low to acknowledge the receipt of the eight data bits.

4.4 Data Input

During data input, the device samples Serial Data (SDA) on the rising edge of Serial Clock (SCL). For correct device operation, Serial Data (SDA) must be stable during the rising edge of Serial Clock (SCL), and the Serial Data (SDA) signal must change *only* when Serial Clock (SCL) is driven low.

4.5 Memory addressing

To start communication between the bus master and the slave device, the bus master must initiate a Start condition. Following this, the bus master sends the device select code, shown in [Table 2](#) (on Serial Data (SDA), most significant bit first).

Table 4. Device select code

	Device type identifier ⁽¹⁾				Chip Enable address ⁽²⁾			R \overline{W}
	b7	b6	b5	b4	b3	b2	b1	b0
Device select code when addressing the memory array	1	0	1	0	E2	E1	E0	R \overline{W}
Device select code when accessing the Identification page	1	0	1	1	E2	E1	E0	R \overline{W}

1. The most significant bit, b7, is sent first.

2. E0, E1 and E2 are compared against the respective external pins on the memory device.

The device select code consists of a 4-bit device type identifier, and a 3-bit Chip Enable "Address" (E2, E1, E0). The 4-bit device type identifier 1010b addresses the memory array (M24C32 and M24C32-D), and the 4-bit device type identifier 1011b addresses the Identification page (M24C32-D only). A device select code handling a value other than 1010b or 1011b is not acknowledged by the device.

Up to eight memory devices can be connected on a single I²C bus. Each one is given a unique 3-bit code on the Chip Enable (E2, E1, E0) inputs. When the device select code is received, the device only responds if the Chip Enable Address is the same as the value on the Chip Enable (E2, E1, E0) inputs.

The 8th bit is the Read/Write bit (R \overline{W}). This bit is set to 1 for Read and 0 for Write operations.

If a match occurs on the device select code, the corresponding device gives an acknowledgment on Serial Data (SDA) during the 9th bit time. If the device does not match the device select code, it deselects itself from the bus, and goes into Standby mode.

Table 5. Operating modes

Mode	R \overline{W} bit	\overline{WC} ⁽¹⁾	Bytes	Initial sequence
Current Address Read	1	X	1	Start, device select, R \overline{W} = 1
Random Address Read	0	X	1	Start, device select, R \overline{W} = 0, Address
	1	X		reStart, device select, R \overline{W} = 1
Sequential Read	1	X	≥ 1	Similar to Current or Random Address Read
Byte Write	0	V _{IL}	1	Start, device select, R \overline{W} = 0
Page Write	0	V _{IL}	≤ 32	Start, device select, R \overline{W} = 0

1. X = V_{IH} or V_{IL}.

Figure 8. Write mode sequences with $\overline{WC} = 1$ (data write inhibited)

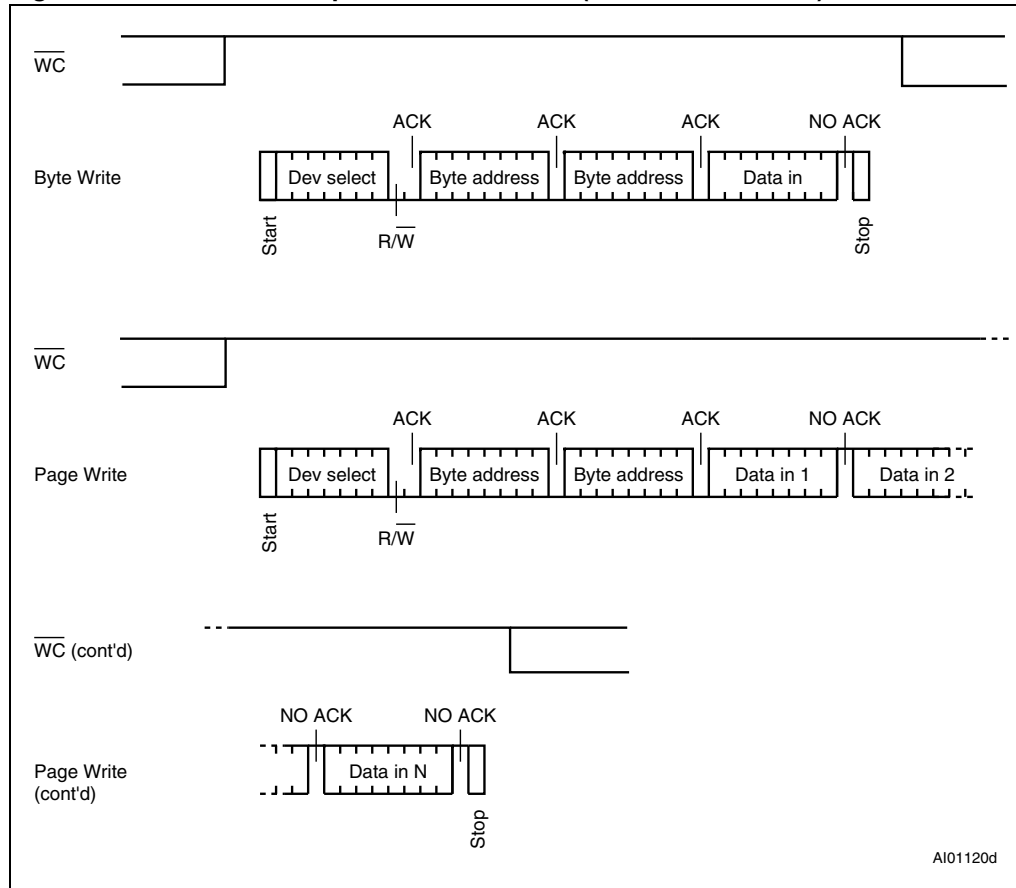

4.6 Write operations

Following a Start condition the bus master sends a device select code with the Read/Write bit (\overline{RW}) reset to 0. The device acknowledges this, as shown in [Figure 9](#), and waits for two address bytes. The device responds to each address byte with an acknowledge bit, and then waits for the data Byte.

Each data byte in the memory has a 16-bit (two byte wide) address. The Most Significant Byte ([Table 2](#)) is sent first, followed by the Least Significant Byte ([Table 3](#)). Bits b15 to b0 form the address of the byte in memory.

When the bus master generates a Stop condition immediately after a data byte Ack bit (in the “10th bit” time slot), either at the end of a Byte Write or a Page Write, the internal Write cycle is triggered. A Stop condition at any other time slot does not trigger the internal Write cycle.

After the Stop condition, the delay t_{WV} , and the successful completion of a Write operation, the device’s internal address counter is incremented automatically, to point to the next byte address after the last one that was modified.

During the internal Write cycle, Serial Data (SDA) is disabled internally, and the device does not respond to any requests.

If the Write Control input (WC) is driven High, the Write instruction is not executed and the accompanying data bytes are not acknowledged, as shown in [Figure 8](#).

4.7 Byte Write

After the device select code and the address bytes, the bus master sends one data byte. If the addressed location is Write-protected, by Write Control (\overline{WC}) being driven high, the device replies with NoAck, and the location is not modified. If, instead, the addressed location is not Write-protected, the device replies with Ack. The bus master terminates the transfer by generating a Stop condition, as shown in [Figure 9](#).

4.8 Page Write

The Page Write mode allows up to 32 bytes to be written in a single Write cycle, provided that they are all located in the same ‘row’ in the memory: that is, the most significant memory address bits (b11-b5) are the same. If more bytes are sent than will fit up to the end of the row, a condition known as ‘roll-over’ occurs. This should be avoided, as data starts to become overwritten in an implementation dependent way.

The bus master sends from 1 to 32 bytes of data, each of which is acknowledged by the device if Write Control (\overline{WC}) is low. If Write Control (\overline{WC}) is high, the contents of the addressed memory location are not modified, and each data byte is followed by a NoAck. After each byte is transferred, the internal byte address counter (inside the page) is incremented. The transfer is terminated by the bus master generating a Stop condition.

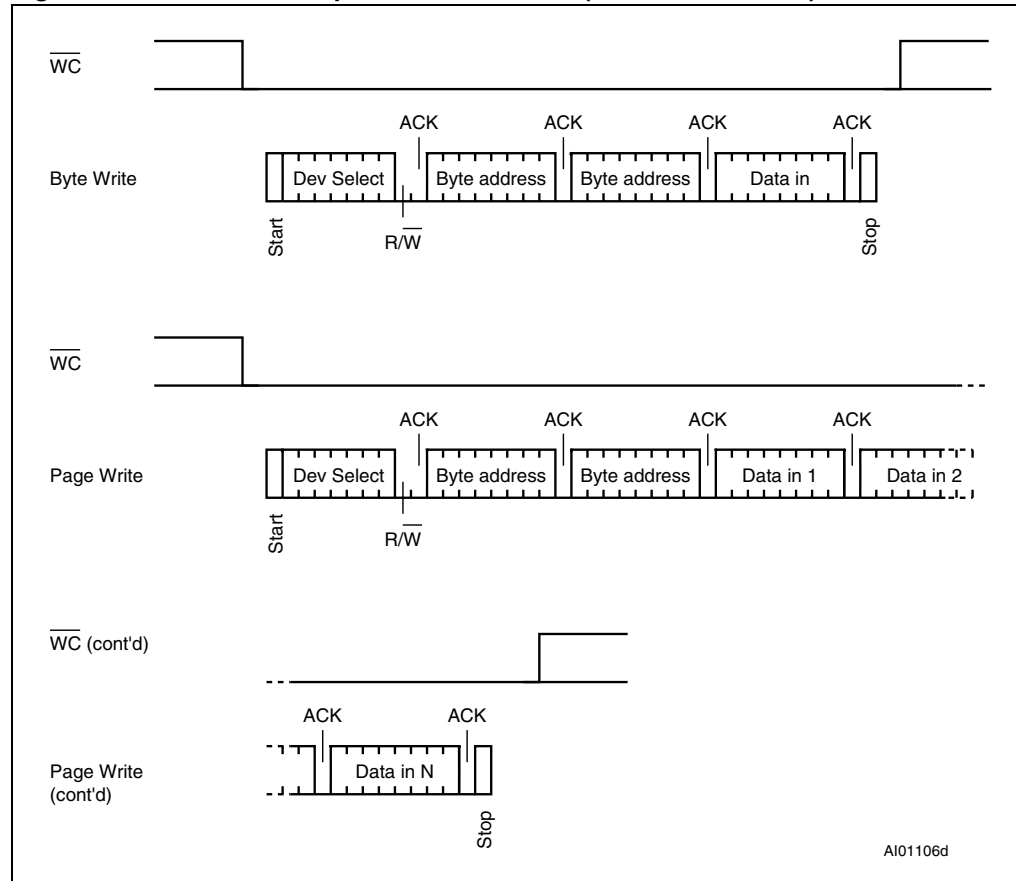
Figure 9. Write mode sequences with $\overline{WC} = 0$ (data write enabled)

4.9 Write Identification Page (M24C32-D only)

The Identification Page (32 bytes) is an additional page which can be written and (later) permanently locked in Read-only mode. The Identification Page is written by issuing an Write Identification Page instruction. This instruction uses the same protocol and format as Page Write (into memory array), except for the following differences:

- Device type identifier = 1011b
- MSB address bits A15/A5 are don't care except for address bit A10 which must be '0'.

LSB address bits A4/A0 define the byte address inside the Identification Page.

If the Identification Page is locked, the data bytes transferred during the Write Identification Page instruction are not acknowledged (NoAck).

4.10 Lock Identification Page (M24C32-D only)

The Lock Identification Page instruction (Lock ID) permanently locks the Identification Page in Read-only mode. The Lock ID instruction is similar to Byte Write (into memory array) with the following specific conditions:

- Device type identifier = 1011b
- Address bit A10 must be '1'; all other address bits are don't care
- The data byte must be equal to the binary value xxxx xx1x, where x is don't care

If the Identification Page is locked, the data bytes transferred during the Lock Identification Page instruction are not acknowledged (NoAck).

4.11 ECC (Error Correction Code) and Write cycling

The M24C32 devices identified with the process letter K offer an ECC (Error Correction Code) logic which compares each 4-byte word with its associated 6 EEPROM bits of ECC. As a result, if a single bit out of 4 bytes of data happens to be erroneous during a Read operation, the ECC detects it and replaces it by the correct value. The read reliability is therefore much improved by the use of this feature.

Note however that even if a single byte has to be written, 4 bytes are internally modified (plus the ECC bits), that is, the addressed byte is cycled together with the three other bytes making up the word. It is therefore recommended to write by word (4 bytes) at address $4*N$ (where N is an integer) in order to benefit from the larger amount of Write cycles.

The M24C32 devices are qualified as 1 million (1,000,000) Write cycles, using a cycling routine that writes to the device by multiples of 4-byte words.

Figure 10. Write cycle polling flowchart using ACK

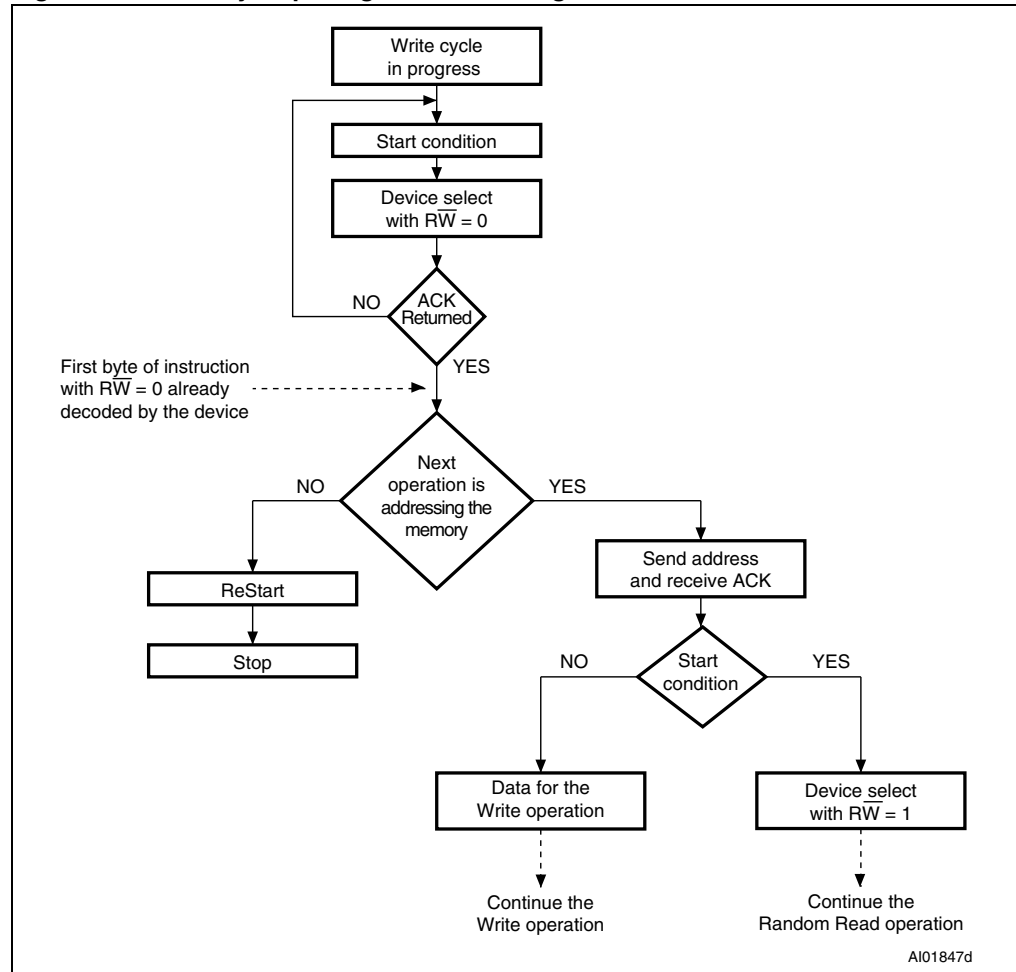

4.12 Minimizing system delays by polling on ACK

During the internal Write cycle, the device disconnects itself from the bus, and writes a copy of the data from its internal latches to the memory cells. The maximum Write time (t_w) is shown in [Table 17](#), but the typical time is shorter. To make use of this, a polling sequence can be used by the bus master.

The sequence, as shown in [Figure 10](#), is:

1. Initial condition: a Write cycle is in progress.
2. Step 1: the bus master issues a Start condition followed by a device select code (the first byte of the new instruction).
3. Step 2: if the device is busy with the internal Write cycle, no Ack will be returned and the bus master goes back to Step 1. If the device has terminated the internal Write cycle, it responds with an Ack, indicating that the device is ready to receive the second part of the instruction (the first byte of this instruction having been sent during Step 1).

Figure 11. Read mode sequences

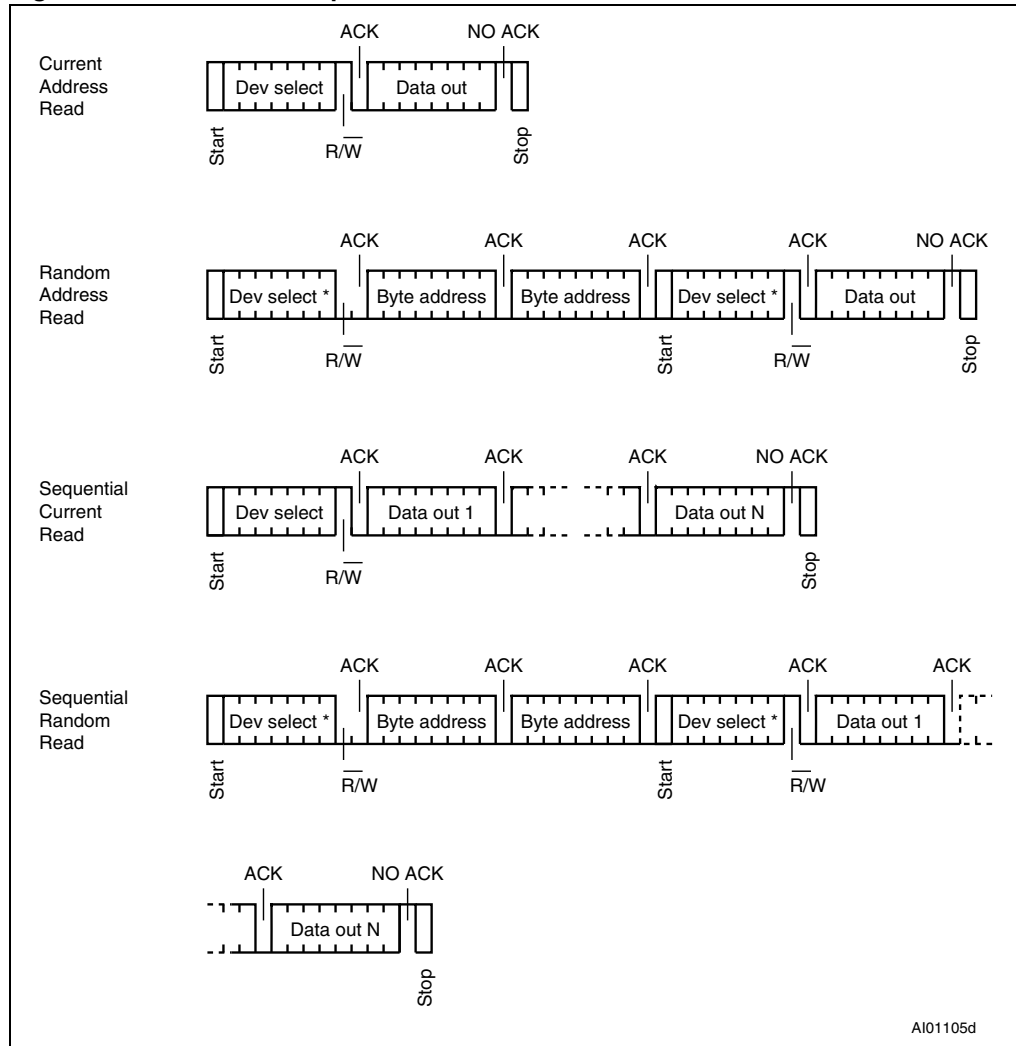

1. The seven most significant bits of the device select code of a Random Read (in the 1st and 4th bytes) must be identical.

4.13 Read operations

Read operations are performed independently of the state of the Write Control (\overline{WC}) signal. After the successful completion of a Read operation, the device's internal address counter is incremented by one, to point to the next byte address.

4.14 Random Address Read

A dummy Write is first performed to load the address into this address counter (as shown in [Figure 11](#)) but *without* sending a Stop condition. Then, the bus master sends another Start condition, and repeats the device select code, with the Read/Write bit (\overline{RW}) set to 1. The device acknowledges this, and outputs the contents of the addressed byte. The bus master must *not* acknowledge the byte, and terminates the transfer with a Stop condition.

4.15 Current Address Read

For the Current Address Read operation, following a Start condition, the bus master only sends a device select code with the Read/Write bit (\overline{RW}) set to 1. The device acknowledges this, and outputs the byte addressed by the internal address counter. The counter is then incremented. The bus master terminates the transfer with a Stop condition, as shown in [Figure 11](#), *without* acknowledging the Byte.

4.16 Sequential Read

This operation can be used after a Current Address Read or a Random Address Read. The bus master *does* acknowledge the data byte output, and sends additional clock pulses so that the device continues to output the next byte in sequence. To terminate the stream of bytes, the bus master must *not* acknowledge the last byte, and *must* generate a Stop condition, as shown in [Figure 11](#).

The output data comes from consecutive addresses, with the internal address counter automatically incremented after each byte output. After the last memory address, the address counter 'rolls-over', and the device continues to output data from memory address 00h.

4.17 Read Identification Page (M24C32-D)

The Identification Page (32 bytes) is an additional page which can be written and (later) permanently locked in Read-only mode.

The Identification Page can be read by issuing an Read Identification Page instruction. This instruction uses the same protocol and format as the Random Address Read (from memory array) with device type identifier defined as 1011b. The MSB address bits A15/A5 are don't care, the LSB address bits A4/A0 define the byte address inside the Identification Page. The number of bytes to read in the ID page must not exceed the page boundary, otherwise unexpected data is read (e.g.: when reading the Identification Page from location 10d, the number of bytes should be less than or equal to 22, as the ID page boundary is 32 bytes).

4.18 Read the lock status (M24C32-D)

The locked/unlocked status of the Identification page can be checked by issuing a specific truncated command [Identification Page Write instruction + one data byte]: this data byte will be acknowledged if the Identification page is unlocked, while it will not be acknowledged if the Identification page is locked.

Once the acknowledge bit of this data byte is read, it is recommended to generate a Start condition followed by a Stop condition, so that:

- Start: the truncated command is not executed because the Start condition resets the device internal logic,
- Stop: the device is then set back into Standby mode by the Stop condition.

4.19 Acknowledge in Read mode

For all Read commands, the device waits, after each byte read, for an acknowledgment during the 9th bit time. If the bus master does not drive Serial Data (SDA) low during this time, the device terminates the data transfer and switches to its Standby mode.

5 Initial delivery state

The device is delivered with all bits in the memory array set to 1 (each byte contains FFh).

6 Maximum rating

Stressing the device outside the ratings listed in [Table 6](#) may cause permanent damage to the device. These are stress ratings only, and operation of the device at these, or any other conditions outside those indicated in the Operating sections of this specification, is not implied. Exposure to absolute maximum rating conditions for extended periods may affect device reliability. Refer also to the STMicroelectronics SURE Program and other relevant quality documents.

Table 6. Absolute maximum ratings

Symbol	Parameter	Min.	Max.	Unit
	Ambient operating temperature	-40	130	°C
T _{STG}	Storage temperature	-65	150	°C
T _{LEAD}	Lead temperature during soldering	see note ⁽¹⁾		°C
	PDIP-specific lead temperature during soldering		260 ⁽²⁾	°C
V _{IO}	Input or output range	-0.50	6.5	V
I _{OL}	DC output current (SDA = 0)	-	5	mA
V _{CC}	Supply voltage	-0.50	6.5	V
V _{ESD}	Electrostatic pulse (human body model) ⁽³⁾		4000	V

1. Compliant with JEDEC Std J-STD-020D (for small body, Sn-Pb or Pb assembly), the ST ECOPACK® 7191395 specification, and the European directive on Restrictions on Hazardous Substances (RoHS) 2002/95/EU.
2. T_{LEAD} max must not be applied for more than 10 s.
3. Positive and negative pulses applied on pin pairs, according to the AEC-Q100-002 (compliant with JEDEC Std JESD22-A114, C1=100pF, R1=1500Ω, R2=500Ω)

7 DC and AC parameters

Table 7. Operating conditions (M24xxx-W)

Symbol	Parameter	Min.	Max.	Unit
V_{CC}	Supply voltage	2.5	5.5	V
T_A	Ambient operating temperature (device grade 6)	-40	85	°C
	Ambient operating temperature (device grade 3)	-40	125	°C
f_C	Operating clock frequency	-	1	MHz

Table 8. Operating conditions (M24xxx-R)

Symbol	Parameter	Min.	Max.	Unit
V_{CC}	Supply voltage	1.8	5.5	V
T_A	Ambient operating temperature	-40	85	°C
f_C	Operating clock frequency	-	1	MHz

Table 9. Operating conditions (M24xxx-F)

Symbol	Parameter	Min.	Max.	Unit
V_{CC}	Supply voltage	1.7	5.5	V
T_A	Ambient operating temperature (device grade 6)	-40	85	°C
	Ambient operating temperature (device grade 5)	-20	85	°C

Table 10. AC test measurement conditions

Symbol	Parameter	Min.	Max.	Unit
C_{bus}	Load capacitance	100		pF
	SCL input rise/fall time, SDA input fall time		50	ns
	Input voltage levels	0.2V _{CC} to 0.8V _{CC}		V
	Input and output timing reference levels	0.3V _{CC} to 0.7V _{CC}		V

Figure 12. AC test measurement I/O waveform

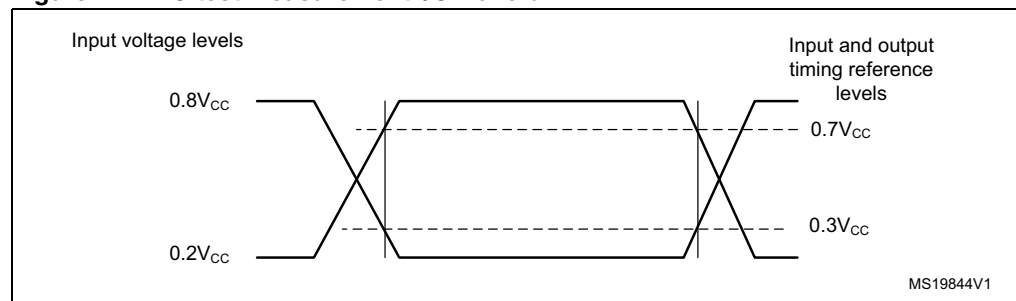

Table 11. Input parameters

Symbol	Parameter ⁽¹⁾	Test condition	Min.	Max.	Unit
C_{IN}	Input capacitance (SDA)			8	pF
C_{IN}	Input capacitance (other pins)			6	pF
$Z_L^{(2)}$	Input impedance (E2, E1, E0, WC)	$V_{IN} < 0.3V_{CC}$	30		k Ω
$Z_H^{(2)}$	Input impedance (E2, E1, E0, WC)	$V_{IN} > 0.7V_{CC}$	500		k Ω

1. Characterized value, not tested in production.

2. E2,E1,E0: Input impedance when the memory is selected (after a Start condition).

Table 12. Memory cell characteristics

Symbol	Parameter	Test condition	Min.	Max.	Unit
N_{cycle}	Endurance	$TA = 25^{\circ}C, 1.8 V < V_{CC} < 5.5 V$	1,000,000	-	Write cycle

Note: This parameter is not tested but established by characterization and qualification. For endurance estimates in a specific application, please refer to AN2014.

Table 13. DC characteristics (M24xxx-W, device grade 6)

Symbol	Parameter	Test conditions (see Table 7 and Table 10)	Min.	Max.	Unit
I_{LI}	Input leakage current (SCL, SDA, E2, E1, E0)	$V_{IN} = V_{SS}$ or V_{CC} device in Standby mode		± 2	μA
I_{LO}	Output leakage current	SDA in Hi-Z, external voltage applied on SDA: V_{SS} or V_{CC}		± 2	μA
I_{CC}	Supply current (Read)	$2.5 V < V_{CC} < 5.5 V$, $f_C = 400 kHz$ (rise/fall time $< 50 ns$)		2	mA
		$2.5 V < V_{CC} < 5.5 V$, $f_C = 1 MHz^{(1)}$ (rise/fall time $< 50 ns$)		2.5	mA
I_{CC0}	Supply current (Write)	During t_W , $2.5 V < V_{CC} < 5.5 V$		$5^{(2)}$	mA
I_{CC1}	Standby supply current	Device not selected ⁽³⁾ , $V_{IN} = V_{SS}$ or V_{CC} , $V_{CC} = 2.5 V$		2	μA
		Device not selected ⁽³⁾ , $V_{IN} = V_{SS}$ or V_{CC} , $V_{CC} = 5.5 V$		$5^{(4)}$	μA
V_{IL}	Input low voltage (SCL, SDA, WC)		-0.45	$0.3V_{CC}$	V
V_{IH}	Input high voltage (SCL, SDA)		$0.7V_{CC}$	6.5	V
	Input high voltage (WC, E2, E1, E0)		$0.7V_{CC}$	$V_{CC}+0.6$	
V_{OL}	Output low voltage	$I_{OL} = 2.1 mA$, $V_{CC} = 2.5 V$ or $I_{OL} = 3 mA$, $V_{CC} = 5.5 V$		0.4	V

1. Only for devices operating at f_C max = 1 MHz (see Table 18)
2. Characterized value, not tested in production.
3. The device is not selected after power-up, after a Read instruction (after the Stop condition), or after the completion of the internal write cycle t_W (t_W is triggered by the correct decoding of a Write instruction).
4. The new M24C32-W devices (identified by the process letter K) offer $I_{CC1} = 3\mu A$ (max)

Table 14. DC characteristics (M24xxx-W - device grade 3)

Symbol	Parameter	Test conditions (in addition to those in Table 7 and Table 10)	Min.	Max.	Unit
I_{LI}	Input leakage current (SCL, SDA, E2, E1, E0)	$V_{IN} = V_{SS}$ or V_{CC} device in Standby mode		± 2	μA
I_{LO}	Output leakage current	SDA in Hi-Z, external voltage applied on SDA: V_{SS} or V_{CC}		± 2	μA
I_{CC}	Supply current (Read)	$f_c = 400$ kHz		2	mA
I_{CC0}	Supply current (Write)	During t_W		5 ⁽¹⁾	mA
I_{CC1}	Standby supply current	Device not selected ⁽²⁾ , $V_{IN} = V_{SS}$ or V_{CC}		10	μA
V_{IL}	Input low voltage (SCL, SDA, WC)		-0.45	$0.3V_{CC}$	V
V_{IH}	Input high voltage (SCL, SDA)		$0.7V_{CC}$	6.5	V
	Input high voltage (WC, E2, E1, E0)		$0.7V_{CC}$	$V_{CC}+0.6$	V
V_{OL}	Output low voltage	$I_{OL} = 2.1$ mA, $V_{CC} = 2.5$ V or $I_{OL} = 3$ mA, $V_{CC} = 5.5$ V		0.4	V

1. Characterized value, not tested in production.
2. The device is not selected after power-up, after a Read instruction (after the Stop condition), or after the completion of the internal write cycle t_W (t_W is triggered by the correct decoding of a Write instruction).

Table 15. DC characteristics (M24xxx-R - device grade 6)

Symbol	Parameter	Test conditions ⁽¹⁾ (in addition to those in Table 8 and Table 10)	Min.	Max.	Unit
I_{LI}	Input leakage current (E1, E2, SCL, SDA)	$V_{IN} = V_{SS}$ or V_{CC} device in Standby mode		± 2	μA
I_{LO}	Output leakage current	SDA in Hi-Z, external voltage applied on SDA: V_{SS} or V_{CC}		± 2	μA
I_{CC}	Supply current (Read)	$V_{CC} = 1.8 V$, $f_c = 400 kHz$		0.8	mA
		$f_c = 1 MHz^{(2)}$		2.5	mA
I_{CC0}	Supply current (Write)	During t_W , $1.8 V < V_{CC} < 2.5 V$		3 ⁽³⁾	mA
I_{CC1}	Standby supply current	Device not selected ⁽⁴⁾ , $V_{IN} = V_{SS}$ or V_{CC} , $V_{CC} = 1.8 V$		1	μA
V_{IL}	Input low voltage (SCL, SDA, WC)	$1.8 V \leq V_{CC} < 2.5 V$	-0.45	$0.25 V_{CC}$	V
V_{IH}	Input high voltage (SCL, SDA)	$1.8 V \leq V_{CC} < 2.5 V$	$0.75 V_{CC}$	6.5	V
	Input high voltage (WC, E2, E1, E0)	$1.8 V \leq V_{CC} < 2.5 V$	$0.75 V_{CC}$	$V_{CC} + 0.6$	V
V_{OL}	Output low voltage	$I_{OL} = 1 mA$, $V_{CC} = 1.8 V$		0.2	V

1. If the application uses the voltage range R device with $2.5 V < V_{CC} < 5.5 V$ and $-40^\circ C < T_A < +85^\circ C$, please refer to [Table 13](#) instead of this table.
2. Only for devices operating at $f_c \text{ max} = 1 MHz$ (see [Table 18](#)).
3. Characterized value, not tested in production.
4. The device is not selected after power-up, after a Read instruction (after the Stop condition), or after the completion of the internal write cycle t_W (t_W is triggered by the correct decoding of a Write instruction).

Table 16. DC characteristics (M24xxx-F)

Symbol	Parameter	Test conditions ⁽¹⁾ (in addition to those in Table 9 and Table 10)	Min.	Max.	Unit
I_{LI}	Input leakage current (E1, E2, SCL, SDA)	$V_{IN} = V_{SS}$ or V_{CC} device in Standby mode		± 2	µA
I_{LO}	Output leakage current	SDA in Hi-Z, external voltage applied on SDA: V_{SS} or V_{CC}		± 2	µA
I_{CC}	Supply current (Read)	$V_{CC} = 1.7$ V, $f_c = 400$ kHz		0.8	mA
		$f_c = 1$ MHz ⁽²⁾		2.5	mA
I_{CC0}	Supply current (Write)	During t_W , 1.7 V < V_{CC} < 2.5 V		3 ⁽³⁾	mA
I_{CC1}	Standby supply current	Device not selected ⁽⁴⁾ , $V_{IN} = V_{SS}$ or V_{CC} , $V_{CC} = 1.7$ V		1	µA
V_{IL}	Input low voltage (SCL, SDA, WC)	1.7 V ≤ V_{CC} < 2.5 V	-0.45	0.25 V_{CC}	V
V_{IH}	Input high voltage (SCL, SDA)	1.7 V ≤ V_{CC} < 2.5 V	0.75 V_{CC}	6.5	V
	Input high voltage (WC, E2, E1, E0)	1.7 V ≤ V_{CC} < 2.5 V	0.75 V_{CC}	$V_{CC} + 0.6$	V
V_{OL}	Output low voltage	$I_{OL} = 1$ mA, $V_{CC} = 1.7$ V		0.2	V

1. If the application uses the voltage range F device with 2.5 V < V_{CC} < 5.5 V and -40 °C < T_A < +85 °C, please refer to [Table 13](#) instead of this table.
2. Only for devices operating at f_c max = 1 MHz (see [Table 18](#)).
3. Characterized value, not tested in production.
4. The device is not selected after power-up, after a Read instruction (after the Stop condition), or after the completion of the internal write cycle t_W (t_W is triggered by the correct decoding of a Write instruction).

Table 17. 400 kHz AC characteristics

Symbol	Alt.	Parameter ⁽¹⁾	Min.	Max.	Unit
f_C	f_{SCL}	Clock frequency	-	400	kHz
t_{CHCL}	t_{HIGH}	Clock pulse width high	600	-	ns
t_{CLCH}	t_{LOW}	Clock pulse width low	1300	-	ns
$t_{QL1QL2}^{(2)}$	t_F	SDA (out) fall time	20 ⁽³⁾	120	ns
t_{XH1XH2}	t_R	Input signal rise time	(4)	(4)	ns
t_{XL1XL2}	t_F	Input signal fall time	(4)	(4)	ns
t_{DXCX}	$t_{SU:DAT}$	Data in set up time	100	-	ns
t_{CLDX}	$t_{HD:DAT}$	Data in hold time	0	-	ns
t_{CLQX}	t_{DH}	Data out hold time	100 ⁽⁵⁾	-	ns
$t_{CLQV}^{(6)(7)}$	t_{AA}	Clock low to next data valid (access time)	100 ⁽⁵⁾	900	ns
t_{CHDL}	$t_{SU:STA}$	Start condition setup time	600	-	ns
t_{DLCL}	$t_{HD:STA}$	Start condition hold time	600	-	ns
t_{CHDH}	$t_{SU:STO}$	Stop condition set up time	600	-	ns
t_{DHDL}	t_{BUF}	Time between Stop condition and next Start condition	1300	-	ns
$t_{WLDL}^{(8)(2)}$	$t_{SU:WC}$	\overline{WC} set up time (before the Start condition)	0	-	μ s
$t_{DHWL}^{(9)(2)}$	$t_{HD:WC}$	\overline{WC} hold time (after the Stop condition)	1	-	μ s
t_W	t_{WR}	Write time	-	5	ms
$t_{NS}^{(2)}$		Pulse width ignored (input filter on SCL and SDA) - single glitch	-	80 ⁽¹⁰⁾	ns

1. Test conditions (in addition to those in [Table 7](#), [Table 8](#), [Table 9](#) and [Table 10](#)).
2. Characterized value, not tested in production.
3. With $C_L = 10$ pF.
4. There is no min. or max. values for the input signal rise and fall times. It is however recommended by the I²C specification that the input signal rise and fall times be more than 20 ns and less than 300 ns when $f_C < 400$ kHz.
5. The new M24C32 device (identified by the process letter K) offers $t_{CLQX} = 100$ ns (min) and $t_{CLQV} = 100$ ns (min), while the current device offers $t_{CLQX} = 200$ ns (min) and $t_{CLQV} = 200$ ns (min). Both series offer a safe margin compared to the I²C specification which recommends $t_{CLQV} = 0$ ns (min).
6. To avoid spurious Start and Stop conditions, a minimum delay is placed between SCL=1 and the falling or rising edge of SDA.
7. t_{CLQV} is the time (from the falling edge of SCL) required by the SDA bus line to reach either 0.3 V_{CC} or 0.7 V_{CC} , assuming that $R_{bus} \times C_{bus}$ time constant is within the values specified in [Figure 4](#).
8. $\overline{WC}=0$ set up time condition to enable the execution of a WRITE command.
9. $\overline{WC}=0$ hold time condition to enable the execution of a WRITE command.
10. The current M24C32 device offers $t_{NS}=100$ ns (max), the new M24C32 device (identified by the process letter K) offers $t_{NS}=80$ ns (max). Both products offer a safe margin compared to the 50 ns minimum value recommended by the I²C specification.

Table 18. 1 MHz AC characteristics⁽¹⁾

Symbol	Alt.	Parameter ⁽²⁾	Min.	Max.	Unit
f_C	f_{SCL}	Clock frequency	0	1	MHz
t_{CHCL}	t_{HIGH}	Clock pulse width high	260	-	ns
t_{CLCH}	t_{LOW}	Clock pulse width low	500	-	ns
t_{XH1XH2}	t_R	Input signal rise time	(3)	(3)	ns
t_{XL1XL2}	t_F	Input signal fall time	(3)	(3)	ns
$t_{QL1QL2}^{(9)}$	t_F	SDA (out) fall time	20 ⁽⁴⁾	120	ns
t_{DXCX}	$t_{SU:DAT}$	Data in setup time	50	-	ns
t_{CLDX}	$t_{HD:DAT}$	Data in hold time	0	-	ns
t_{CLQX}	t_{DH}	Data out hold time	100	-	ns
$t_{CLQV}^{(5)(6)}$	t_{AA}	Clock low to next data valid (access time)		450	ns
t_{CHDL}	$t_{SU:STA}$	Start condition setup time	250	-	ns
t_{DLCL}	$t_{HD:STA}$	Start condition hold time	250	-	ns
t_{CHDH}	$t_{SU:STO}$	Stop condition setup time	250	-	ns
t_{DHDL}	t_{BUF}	Time between Stop condition and next Start condition	500	-	ns
$t_{WLDL}^{(7)(9)}$	$t_{SU:WC}$	\overline{WC} set up time (before the Start condition)	0	-	μ s
$t_{DHWL}^{(8)(9)}$	$t_{HD:WC}$	\overline{WC} hold time (after the Stop condition)	1	-	μ s
t_W	t_{WR}	Write time	-	5	ms
$t_{NS}^{(9)}$		Pulse width ignored (input filter on SCL and SDA)	-	80	ns

1. Only M24C32 and M24C64-D devices identified by the process letter K are qualified at 1 MHz.
2. Test conditions (in addition to those in [Table 7](#), [Table 8](#), [Table 9](#) and [Table 10](#)).
3. There is no min. or max. values for the input signal rise and fall times. It is however recommended by the I²C specification that the input signal rise and fall times be more than 20 ns and less than 300 ns when $f_C < 400$ kHz, or less than 120 ns when $f_C < 1$ MHz.
4. With $C_L = 10$ pF
5. To avoid spurious Start and Stop conditions, a minimum delay is placed between SCL=1 and the falling or rising edge of SDA.
6. t_{CLQV} is the time (from the falling edge of SCL) required by the SDA bus line to reach either $0.3 V_{CC}$ or $0.7 V_{CC}$, assuming that the $R_{bus} \times C_{bus}$ time constant is within the values specified in [Figure 5](#).
7. $\overline{WC}=0$ set up time condition to enable the execution of a WRITE command.
8. $\overline{WC}=0$ hold time condition to enable the execution of a WRITE command.
9. Characterized only, not tested in production.

Figure 13. AC waveforms

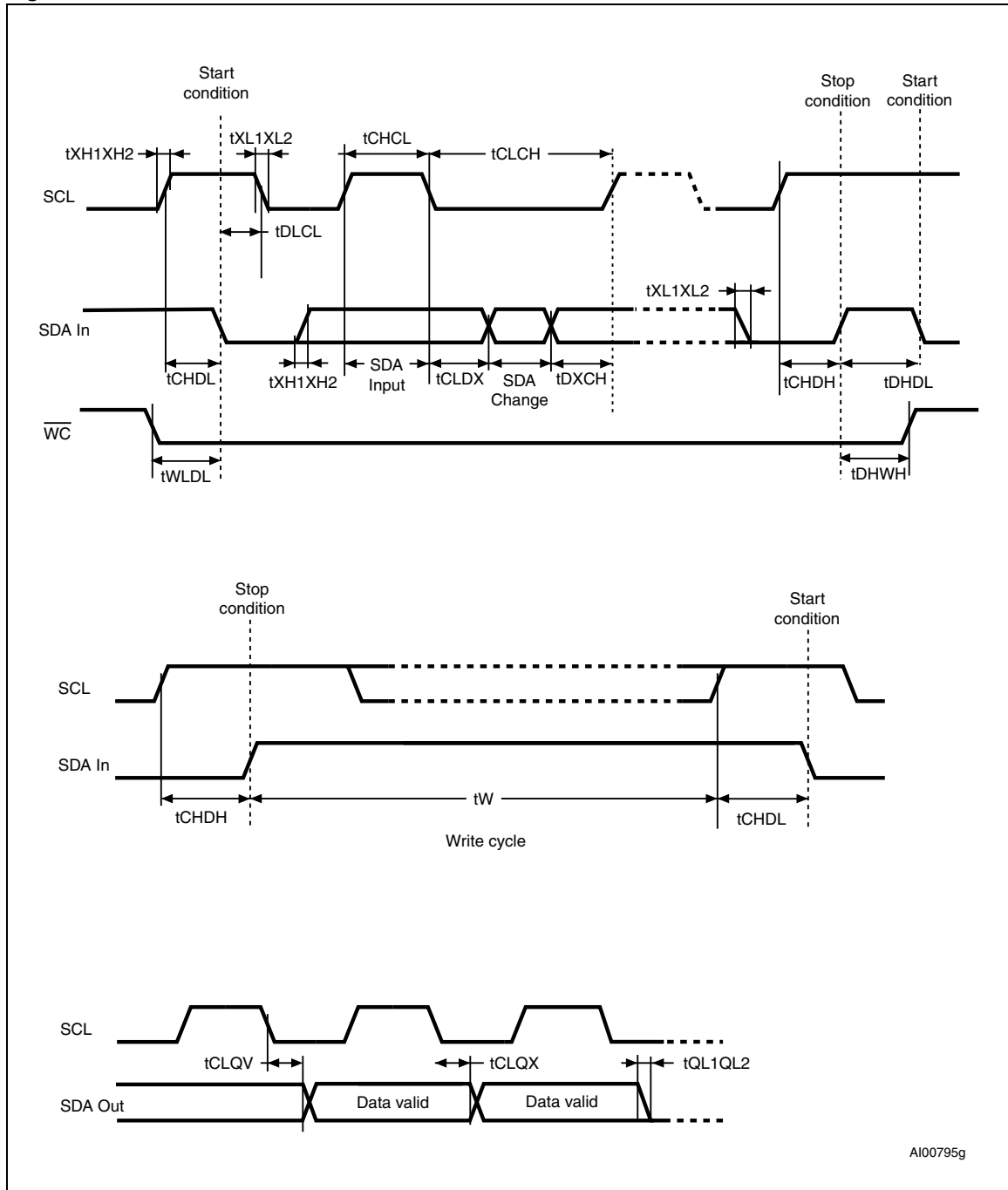

8 Package mechanical data

In order to meet environmental requirements, ST offers these devices in different grades of ECOPACK[®] packages, depending on their level of environmental compliance. ECOPACK[®] specifications, grade definitions and product status are available at: www.st.com. ECOPACK[®] is an ST trademark.

Figure 14. PDIP8 – 8 pin plastic DIP, 0.25 mm lead frame, package outline

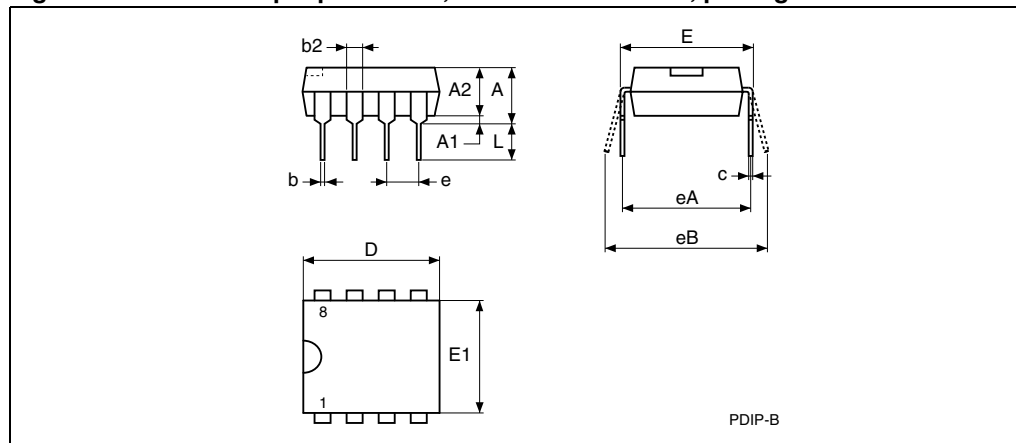

1. Drawing is not to scale.

Table 19. PDIP8 – 8 pin plastic DIP, 0.25 mm lead frame, package mechanical data

Symbol	millimeters			inches ⁽¹⁾		
	Typ.	Min.	Max.	Typ.	Min.	Max.
A			5.33			0.2098
A1		0.38			0.0150	
A2	3.30	2.92	4.95	0.1299	0.1150	0.1949
b	0.46	0.36	0.56	0.0181	0.0142	0.0220
b2	1.52	1.14	1.78	0.0598	0.0449	0.0701
c	0.25	0.20	0.36	0.0098	0.0079	0.0142
D	9.27	9.02	10.16	0.3650	0.3551	0.4000
E	7.87	7.62	8.26	0.3098	0.3000	0.3252
E1	6.35	6.10	7.11	0.2500	0.2402	0.2799
e	2.54	–	–	0.1000	–	–
eA	7.62	–	–	0.3000	–	–
eB			10.92			0.4299
L	3.30	2.92	3.81	0.1299	0.1150	0.1500

1. Values in inches are converted from mm and rounded to four decimal digits.

Figure 15. SO8 narrow – 8 lead plastic small outline, 150 mils body width, package outline

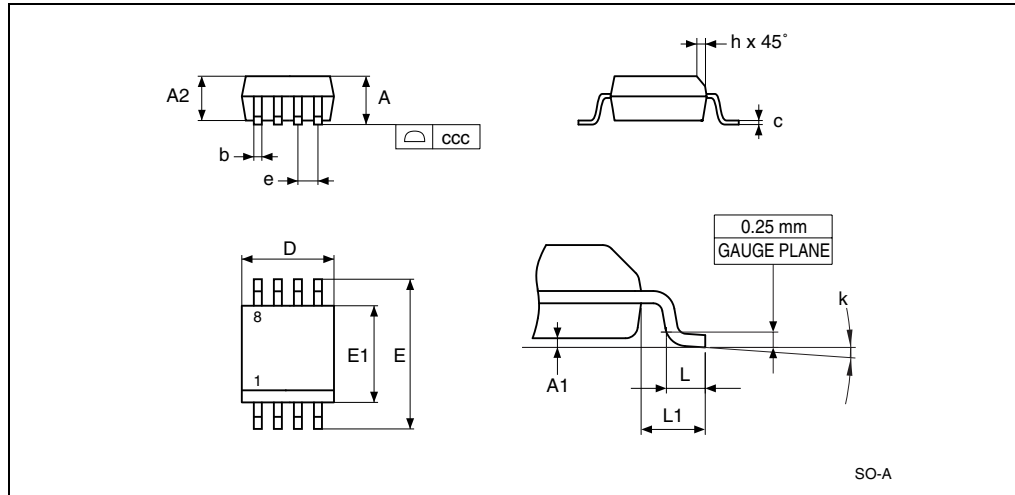

1. Drawing is not to scale.

Table 20. SO8 narrow – 8 lead plastic small outline, 150 mils body width, package mechanical data

Symbol	millimeters			inches ⁽¹⁾		
	Typ	Min	Max	Typ	Min	Max
A			1.75			0.0689
A1		0.10	0.25		0.0039	0.0098
A2		1.25			0.0492	
b		0.28	0.48		0.0110	0.0189
c		0.17	0.23		0.0067	0.0091
ccc			0.10			0.0039
D	4.90	4.80	5.00	0.1929	0.1890	0.1969
E	6.00	5.80	6.20	0.2362	0.2283	0.2441
E1	3.90	3.80	4.00	0.1535	0.1496	0.1575
e	1.27	–	–	0.0500	–	–
h		0.25	0.50			
k		0°	8°		0°	8°
L		0.40	1.27		0.0157	0.0500
L1	1.04			0.0410		

1. Values in inches are converted from mm and rounded to four decimal digits.

Figure 16. TSSOP8 – 8 lead thin shrink small outline, package outline

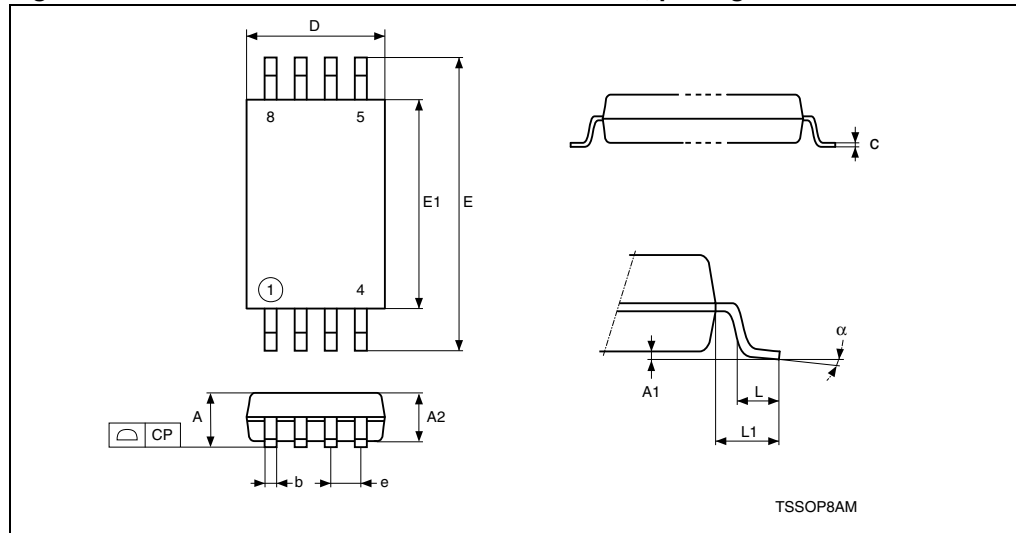

1. Drawing is not to scale.

Table 21. TSSOP8 – 8 lead thin shrink small outline, package mechanical data

Symbol	millimeters			inches ⁽¹⁾		
	Typ.	Min.	Max.	Typ.	Min.	Max.
A			1.200			0.0472
A1		0.050	0.150		0.0020	0.0059
A2	1.000	0.800	1.050	0.0394	0.0315	0.0413
b		0.190	0.300		0.0075	0.0118
c		0.090	0.200		0.0035	0.0079
CP			0.100			0.0039
D	3.000	2.900	3.100	0.1181	0.1142	0.1220
e	0.650	–	–	0.0256	–	–
E	6.400	6.200	6.600	0.2520	0.2441	0.2598
E1	4.400	4.300	4.500	0.1732	0.1693	0.1772
L	0.600	0.450	0.750	0.0236	0.0177	0.0295
L1	1.000			0.0394		
α		0°	8°		0°	8°

1. Values in inches are converted from mm and rounded to four decimal digits.

**Figure 17. UFDFPN8 (MLP8) – 8-lead ultra thin fine pitch dual flat package no lead
2 × 3 mm, package outline**

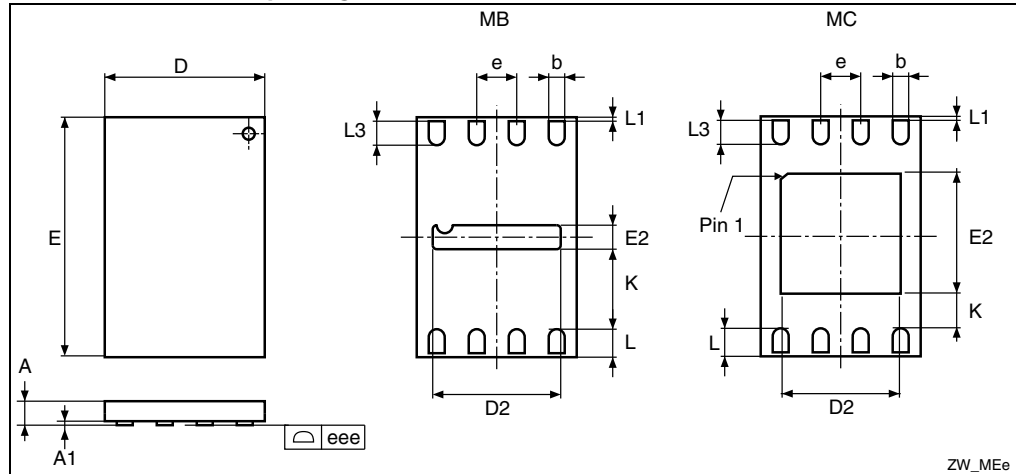

1. Drawing is not to scale.
2. The central pad (E2 × D2 area in the above illustration) is internally pulled to V_{SS}. It must not be allowed to be connected to any other voltage or signal line on the PCB, for example during the soldering process.
3. The circle in the top view of the package indicates the position of pin 1.

**Table 22. UFDFPN8 (MLP8) 8-lead ultra thin fine pitch dual flat package no lead
2 x 3 mm, data**

Symbol	millimeters			inches ⁽¹⁾		
	Typ	Min	Max	Typ	Min	Max
A	0.550	0.450	0.600	0.0217	0.0177	0.0236
A1	0.020	0.000	0.050	0.0008	0.0000	0.0020
b	0.250	0.200	0.300	0.0098	0.0079	0.0118
D	2.000	1.900	2.100	0.0787	0.0748	0.0827
D2 (rev MB)	1.600	1.500	1.700	0.0630	0.0591	0.0669
D2 (rev MC)		1.200	1.600		0.0472	0.0630
E	3.000	2.900	3.100	0.1181	0.1142	0.1220
E2 (rev MB)	0.200	0.100	0.300	0.0079	0.0039	0.0118
E2 (rev MC)		1.200	1.600		0.0472	0.0630
e	0.500			0.0197		
K		0.300			0.0118	
L		0.300	0.500		0.0118	0.0197
L1			0.150			0.0059
L3		0.300			0.0118	
eee ⁽²⁾		0.080			0.0031	

1. Values in inches are converted from mm and rounded to four decimal digits.
2. Applied for exposed die paddle and terminals. Exclude embedding part of exposed die paddle from measuring.

9 Part numbering

Table 23. Ordering information scheme

Example:

M24C32-D

W MN 6 T P /P

Device type

M24 = I²C serial access EEPROM

Device function

C32- = 32 Kbit (4096 x 8)

Device family

Blank: Without Identification page

-D: With additional Identification page

Operating voltage

W = V_{CC} = 2.5 V to 5.5 V

R = V_{CC} = 1.8 V to 5.5 V

F = V_{CC} = 1.7 V to 5.5 V

Package

BN = PDIP8⁽¹⁾

MN = SO8 (150 mil width)⁽²⁾

DW = TSSOP8 (169 mil width)⁽²⁾

MB or MC = UDFPN8 (MLP8)

Device grade

6 = Industrial: device tested with standard test flow over -40 to 85 °C

3 = Automotive: device tested with high-reliability certified flow over -40 to 125°C

5 = Consumer: device tested with standard test flow over -20 to 85°C

Option

blank = standard packing

T = Tape and reel packing

Plating technology

P or G = ECOPACK[®] (RoHS compliant)

Process⁽³⁾

P = F6DP26% Chartered (process letter used only when ordering a device grade 3)

K = F8H process

1. ECOPACK1[®] (RoHS-compliant).
2. ECOPACK2[®] (RoHS-compliant and halogen-free).
3. Process letter is used only for device grade 3.

For a list of available options (speed, package, etc.) or for further information on any aspect of this device, please contact your nearest ST sales office.

10 Revision history

Table 24. Document revision history

Date	Revision	Changes
22-Dec-1999	2.3	TSSOP8 package in place of TSSOP14 (pp 1, 2, OrderingInfo, PackageMechData).
28-Jun-2000	2.4	TSSOP8 package data corrected
31-Oct-2000	2.5	References to Temperature Range 3 removed from Ordering Information Voltage range -S added, and range -R removed from text and tables throughout.
20-Apr-2001	2.6	Lead Soldering Temperature in the Absolute Maximum Ratings table amended Write Cycle Polling Flow Chart using ACK illustration updated References to PSDIP changed to PDIP and Package Mechanical data updated
16-Jan-2002	2.7	Test condition for I_{L1} made more precise, and value of I_{L1} for E2-E0 and WC added -R voltage range added
02-Aug-2002	2.8	Document reformatted using new template. TSSOP8 (3x3mm ² body size) package (MSOP8) added. 5ms write time offered for 5V and 2.5V devices
04-Feb-2003	2.9	SO8W package removed. -S voltage range removed
27-May-2003	2.10	TSSOP8 (3x3mm ² body size) package (MSOP8) removed
22-Oct-2003	3.0	Table of contents, and Pb-free options added. Minor wording changes in Summary Description, Power-On Reset, Memory Addressing, Write Operations, Read Operations. $V_{IL}(\min)$ improved to -0.45V.
01-Jun-2004	4.0	Absolute Maximum Ratings for $V_{IO}(\min)$ and $V_{CC}(\min)$ improved. Soldering temperature information clarified for RoHS compliant devices. Device Grade clarified
04-Nov-2004	5.0	Product List summary table added. Device Grade 3 added. 4.5-5.5V range is Not for New Design. Some minor wording changes. AEC-Q100-002 compliance. $t_{NS}(\max)$ changed. $V_{IL}(\min)$ is the same on all input pins of the device. Z_{WCL} changed.
05-Jan-2005	6.0	UFDFPN8 package added. Small text changes.

Table 24. Document revision history (continued)

Date	Revision	Changes
29-Jun-2006	7	<p>Document converted to new ST template.</p> <p>M24C32 and M24C64 products (4.5 to 5.5V supply voltage) removed.</p> <p>M24C64 and M24C32 products (1.7 to 5.5V supply voltage) added.</p> <p>Section 2.3: Chip Enable (E2, E1, E0) and Section 2.4: Write Control (WC) modified, Section 2.6: Supply voltage (VCC) added and replaces Power On Reset: VCC Lock-Out Write Protect section.</p> <p>T_A added, Note 1 updated and T_{LEAD} specified for PDIP packages in Table 6: Absolute maximum ratings.</p> <p>I_{CC0} added, I_{CC} voltage conditions changed and I_{CC1} specified over the whole voltage range in Table 13: DC characteristics (M24xxx-W, device grade 6).</p> <p>I_{CC0} added, I_{CC} frequency conditions changed and I_{CC1} specified over the whole voltage range in Table 15: DC characteristics (M24xxx-R - device grade 6).</p> <p>t_W modified in Table 16: AC characteristics.</p> <p>SO8N package specifications updated (see Figure 15 and Table 20).</p> <p>Device grade 5 added, B and P Process letters added to Table 23: Ordering information scheme. Small text changes.</p>
03-Jul-2006	8	<p>I_{CC1} modified in Table 13: DC characteristics (M24xxx-W, device grade 6).</p> <p>Note 1 added to Table 16: DC characteristics (M24xxx-F) and table title modified.</p>
17-Oct-2006	9	<p>UFDFPN8 package specifications updated (see Table 21). M24128-BW- and M24128-BR part numbers added.</p> <p>Generic part number corrected in Features on page 1.</p> <p>I_{CC0} corrected in Table 13 and Table 14.</p> <p>Packages are ECOPACK® compliant.</p>
27-Apr-2007	10	<p>Available packages and temperature ranges by product specified in Table 22, Table 24 and Table 25.</p> <p>Notes modified below Table 11: Input parameters.</p> <p>V_{IH} max modified in DC characteristics tables (see Table 14, Table 15, Table 15 and Table 16).</p> <p>C process code added to Table 23: Ordering information scheme.</p> <p>For M24xxx-R (1.8 V to 5.5 V range) products assembled from July 2007 on, t_W will be 5 ms (see Table 16: AC characteristics).</p>
27-Nov-2007	11	<p>Small text changes. Section 2.5: VSS ground and Section 4.11: ECC (Error Correction Code) and Write cycling added.</p> <p>V_{IL} and V_{IH} modified in Table 15: DC characteristics (M24xxx-R - device grade 6).</p> <p>JEDEC standard reference updated below Table 6: Absolute maximum ratings.</p> <p>Package mechanical data inch values calculated from mm and rounded to 4 decimal digits (see Section 8: Package mechanical data).</p>

Table 24. Document revision history (continued)

Date	Revision	Changes
18-Dec-2007	12	<p>Added Section 2.6.2: Power-up conditions, updated Section 2.6.3: Device reset, and Section 2.6.4: Power-down conditions in Section 2.6: Supply voltage (VCC).</p> <p>Updated Figure 4: I2C Fast mode (fC = 400 kHz): maximum Rbus value versus bus parasitic capacitance (Cbus).</p> <p>Replace M24128 and M24C64 by M24128-BFMB6 and M24C64-FMB6, respectively, in Section 4.11: ECC (Error Correction Code) and Write cycling.</p> <p>Added temperature grade 6 in Table 9: Operating conditions (M24xxx-F).</p> <p>Updated test conditions for I_{LO} and V_{LO} in Table 13: DC characteristics (M24xxx-W, device grade 6), Table 14: DC characteristics (M24xxx-W - device grade 3), and Table 15: DC characteristics (M24xxx-R - device grade 6).</p> <p>Test condition updated for I_{LO}, and V_{IH} and V_{IL} differentiate for $1.8\text{ V} \leq V_{CC} < 2.5\text{ V}$ and $2.5\text{ V} \leq V_{CC} < 5.5\text{ V}$ in Table 16: DC characteristics (M24xxx-F).</p> <p>Updated Table 16: AC characteristics, and Table 17: AC characteristics (M24xxx-F).</p> <p>Updated Figure 13: AC waveforms.</p> <p>Added M24128-BF in Table 25: Available M24C32 products (package, voltage range, temperature grade).</p> <p>Process B removed from Table 23: Ordering information scheme.</p>
30-May-2008	13	<p>Small text changes.</p> <p>C Process option and Blank Plating technology option removed from Table 23: Ordering information scheme.</p>
15-Jul-2008	14	<p>WLCSP package added (see Figure 3: WLCSP connections (top view, marking side, with balls on the underside) and Section 8: Package mechanical data). Section 4.11: ECC (Error Correction Code) and Write cycling updated.</p>
16-Sep-2008	15	<p>I_{OL} added to Table 6: Absolute maximum ratings.</p> <p>Table 24: Available M24C32 products (package, voltage range, temperature grade) and Table 25: Available M24C32 products (package, voltage range, temperature grade) updated.</p>
05-Jan-2009	16	<p>I2C modes supported specified in Features on page 1.</p> <p>Note removed from Table 16: DC characteristics (M24xxx-F). Small text changes.</p>

Table 24. Document revision history (continued)

Date	Revision	Changes
30-Nov-2009	17	<p>64 and 128 Kbit densities removed.</p> <p><i>Section 2.6.2: Power-up conditions</i> updated.</p> <p><i>Figure 4: I2C Fast mode (fC = 400 kHz): maximum Rbus value versus bus parasitic capacitance (Cbus)</i> updated.</p> <p>I_{CC1} and V_{IH} updated in <i>Table 13: DC characteristics (M24xxx-W, device grade 6)</i>, <i>Table 14: DC characteristics (M24xxx-W - device grade 3)</i>, <i>Table 15: DC characteristics (M24xxx-R - device grade 6)</i> and <i>Table 16: DC characteristics (M24xxx-F)</i>.</p> <p><i>Table 16: AC characteristics</i> modified.</p> <p><i>Figure 13: AC waveforms</i> modified.</p> <p>Note added below <i>Figure 17: UDFPN8 (MLP8) – 8-lead ultra thin fine pitch dual flat package no lead 2 × 3mm, package outline</i>.</p> <p>Small text changes.</p>
18-Mar-2011	18	<p>Added:</p> <ul style="list-style-type: none"> – M24C32-DF and all information concerning the Identification Page: sections 4.9, 4.10, 4.17, 4.18 – ECC section 4.11 – AC table with clock frequency of 1 MHz (Table 18) – Table 4: Device select code <p>Updated:</p> <ul style="list-style-type: none"> – Section 1: Description – Section 4.5: Memory addressing – Section 4.18: Read the lock status (M24C32-D) – Table 6: Absolute maximum ratings – AC/DC tables 13, 17 with values specific to the device identified with process letter K <p>Deleted:</p> <ul style="list-style-type: none"> – Table 2: Device select code – Table 23: Available M24C32 products (package, voltage range, temperature grade)
14-Sep-2011	19	<p>Updated:</p> <ul style="list-style-type: none"> – <i>Figure 4: I2C Fast mode (fC = 400 kHz): maximum Rbus value versus bus parasitic capacitance (Cbus)</i> – <i>Figure 5: I2C Fast mode Plus (fC = 1 MHz): maximum Rbus value versus bus parasitic capacitance (Cbus)</i> <p>Added t_{WLDL} and t_{DHWH} in:</p> <ul style="list-style-type: none"> – Table 17: 400 kHz AC characteristics – Table 18: 1 MHz AC characteristics – Figure 13: AC waveforms <p>Minor text changes.</p>

Please Read Carefully:

Information in this document is provided solely in connection with ST products. STMicroelectronics NV and its subsidiaries ("ST") reserve the right to make changes, corrections, modifications or improvements, to this document, and the products and services described herein at any time, without notice.

All ST products are sold pursuant to ST's terms and conditions of sale.

Purchasers are solely responsible for the choice, selection and use of the ST products and services described herein, and ST assumes no liability whatsoever relating to the choice, selection or use of the ST products and services described herein.

No license, express or implied, by estoppel or otherwise, to any intellectual property rights is granted under this document. If any part of this document refers to any third party products or services it shall not be deemed a license grant by ST for the use of such third party products or services, or any intellectual property contained therein or considered as a warranty covering the use in any manner whatsoever of such third party products or services or any intellectual property contained therein.

UNLESS OTHERWISE SET FORTH IN ST'S TERMS AND CONDITIONS OF SALE ST DISCLAIMS ANY EXPRESS OR IMPLIED WARRANTY WITH RESPECT TO THE USE AND/OR SALE OF ST PRODUCTS INCLUDING WITHOUT LIMITATION IMPLIED WARRANTIES OF MERCHANTABILITY, FITNESS FOR A PARTICULAR PURPOSE (AND THEIR EQUIVALENTS UNDER THE LAWS OF ANY JURISDICTION), OR INFRINGEMENT OF ANY PATENT, COPYRIGHT OR OTHER INTELLECTUAL PROPERTY RIGHT.

UNLESS EXPRESSLY APPROVED IN WRITING BY TWO AUTHORIZED ST REPRESENTATIVES, ST PRODUCTS ARE NOT RECOMMENDED, AUTHORIZED OR WARRANTED FOR USE IN MILITARY, AIR CRAFT, SPACE, LIFE SAVING, OR LIFE SUSTAINING APPLICATIONS, NOR IN PRODUCTS OR SYSTEMS WHERE FAILURE OR MALFUNCTION MAY RESULT IN PERSONAL INJURY, DEATH, OR SEVERE PROPERTY OR ENVIRONMENTAL DAMAGE. ST PRODUCTS WHICH ARE NOT SPECIFIED AS "AUTOMOTIVE GRADE" MAY ONLY BE USED IN AUTOMOTIVE APPLICATIONS AT USER'S OWN RISK.

Resale of ST products with provisions different from the statements and/or technical features set forth in this document shall immediately void any warranty granted by ST for the ST product or service described herein and shall not create or extend in any manner whatsoever, any liability of ST.

ST and the ST logo are trademarks or registered trademarks of ST in various countries.

Information in this document supersedes and replaces all information previously supplied.

The ST logo is a registered trademark of STMicroelectronics. All other names are the property of their respective owners.

© 2011 STMicroelectronics - All rights reserved

STMicroelectronics group of companies

Australia - Belgium - Brazil - Canada - China - Czech Republic - Finland - France - Germany - Hong Kong - India - Israel - Italy - Japan - Malaysia - Malta - Morocco - Philippines - Singapore - Spain - Sweden - Switzerland - United Kingdom - United States of America

www.st.com