



3.0V to 5.5V, Low-Power, up to 1Mbps, True RS-232 Transceivers Using Four 0.1µF External Capacitors

General Description

The MAX3222/MAX3232/MAX3237/MAX3241 transceivers have a proprietary low-dropout transmitter output stage enabling true RS-232 performance from a 3.0V to 5.5V supply with a dual charge pump. The devices require only four small 0.1µF external charge-pump capacitors. The MAX3222, MAX3232, and MAX3241 are guaranteed to run at data rates of 120kbps while maintaining RS-232 output levels. The MAX3237 is guaranteed to run at data rates of 250kbps in the normal operating mode and 1Mbps in the MegaBaud™ operating mode, while maintaining RS-232 output levels.

The MAX3222/MAX3232 have 2 receivers and 2 drivers. The MAX3222 features a 1µA shutdown mode that reduces power consumption and extends battery life in portable systems. Its receivers remain active in shutdown mode, allowing external devices such as modems to be monitored using only 1µA supply current. The MAX3222 and MAX3232 are pin, package, and functionally compatible with the industry-standard MAX242 and MAX232, respectively.

The MAX3241 is a complete serial port (3 drivers/5 receivers) designed for notebook and subnotebook computers. The MAX3237 (5 drivers/3 receivers) is ideal for fast modem applications. Both these devices feature a shutdown mode in which all receivers can remain active while using only 1µA supply current. Receivers R1 (MAX3237/MAX3241) and R2 (MAX3241) have extra outputs in addition to their standard outputs. These extra outputs are always active, allowing external devices such as a modem to be monitored without forward biasing the protection diodes in circuitry that may have VCC completely removed.

The MAX3222, MAX3237, and MAX3241 are available in space-saving TSSOP and SSOP packages.

Applications

Notebook, Subnotebook, and Palmtop Computers
 High-Speed Modems
 Battery-Powered Equipment
 Hand-Held Equipment
 Peripherals
 Printers

Typical Operating Circuits appear at end of data sheet.

MegaBaud and UCSP are trademarks of Maxim Integrated Products, Inc.

*Covered by U.S. Patent numbers 4,636,930; 4,679,134; 4,777,577; 4,797,899; 4,809,152; 4,897,774; 4,999,761; and other patents pending.



Maxim Integrated Products 1

For pricing, delivery, and ordering information, please contact Maxim/Dallas Direct! at 1-888-629-4642, or visit Maxim's website at www.maxim-ic.com.

Next Generation Device Features

- ◆ **For Smaller Packaging:**
MAX3228E/MAX3229E: +2.5V to +5.5V RS-232 Transceivers in UCSP™
- ◆ **For Integrated ESD Protection:**
MAX3222E/MAX3232E/MAX3237E/MAX3241E*/MAX3246E: ±15kV ESD-Protected, Down to 10nA, 3.0V to 5.5V, Up to 1Mbps, True RS-232 Transceivers
- ◆ **For Low-Voltage or Data Cable Applications:**
MAX3380E/MAX3381E: +2.35V to +5.5V, 1µA, 2 Tx/2 Rx RS-232 Transceivers with ±15kV ESD-Protected I/O and Logic Pins

Ordering Information

PART	TEMP RANGE	PIN-PACKAGE
MAX3222CUP	0°C to +70°C	20 TSSOP
MAX3222CAP	0°C to +70°C	20 SSOP
MAX3222CWN	0°C to +70°C	18 SO
MAX3222CPN	0°C to +70°C	18 Plastic DIP

Ordering Information continued at end of data sheet.

Pin Configurations

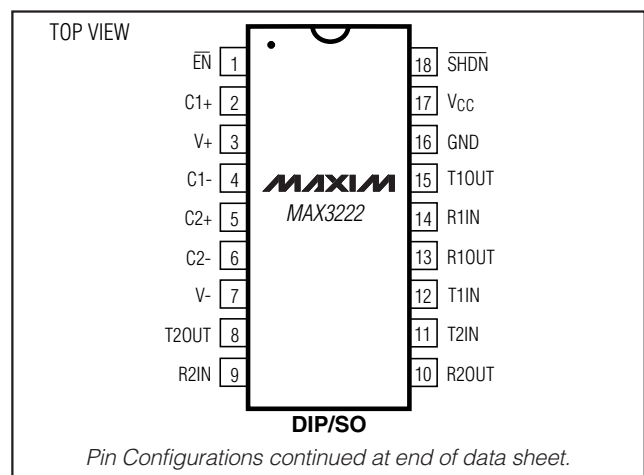

MAX3222/MAX3232/MAX3237/MAX3241*

3.0V to 5.5V, Low-Power, up to 1Mbps, True RS-232 Transceivers Using Four 0.1µF External Capacitors

ABSOLUTE MAXIMUM RATINGS

V _{CC}	-0.3V to +6V
V ₊ (Note 1)	-0.3V to +7V
V ₋ (Note 1)	+0.3V to -7V
V ₊ + V ₋ (Note 1)	+13V
Input Voltages	
T _{IN} , $\overline{\text{SHDN}}$, $\overline{\text{EN}}$	-0.3V to +6V
MBAUD	-0.3V to (V _{CC} + 0.3V)
R _{IN}	±25V
Output Voltages	
T _{OUT}	±13.2V
R _{OUT}	-0.3V to (V _{CC} + 0.3V)
Short-Circuit Duration	
T _{OUT}	Continuous

Continuous Power Dissipation (T _A = +70°C)		
16-Pin TSSOP (derate 6.7mW/°C above +70°C)	533mW	
16-Pin Narrow SO (derate 8.70mW/°C above +70°C)	696mW	
16-Pin Wide SO (derate 9.52mW/°C above +70°C)	762mW	
16-Pin Plastic DIP (derate 10.53mW/°C above +70°C)	842mW	
18-Pin SO (derate 9.52mW/°C above +70°C)	762mW	
18-Pin Plastic DIP (derate 11.11mW/°C above +70°C)	889mW	
20-Pin SSOP (derate 7.00mW/°C above +70°C)	559mW	
20-Pin TSSOP (derate 8.0mW/°C above +70°C)	640mW	
28-Pin TSSOP (derate 8.7mW/°C above +70°C)	696mW	
28-Pin SSOP (derate 9.52mW/°C above +70°C)	762mW	
28-Pin SO (derate 12.50mW/°C above +70°C)	1W	
Operating Temperature Ranges		
MAX32__C__	0°C to +70°C	
MAX32__E__	-40°C to +85°C	
Storage Temperature Range		-65°C to +150°C
Lead Temperature (soldering, 10s)		+300°C

Note 1: V₊ and V₋ can have a maximum magnitude of 7V, but their absolute difference cannot exceed 13V.

Stresses beyond those listed under "Absolute Maximum Ratings" may cause permanent damage to the device. These are stress ratings only, and functional operation of the device at these or any other conditions beyond those indicated in the operational sections of the specifications is not implied. Exposure to absolute maximum rating conditions for extended periods may affect device reliability.

ELECTRICAL CHARACTERISTICS

(V_{CC} = +3.0V to +5.5V, C1–C4 = 0.1µF (Note 2), T_A = T_{MIN} to T_{MAX}, unless otherwise noted. Typical values are at T_A = +25°C.)

PARAMETER	CONDITIONS	MIN	TYP	MAX	UNITS	
DC CHARACTERISTICS						
V _{CC} Power-Supply Current	No load, V _{CC} = 3.3V or 5.0V, T _A = +25°C	MAX3222/MAX3232/ MAX3241		0.3	1.0	mA
		MAX3237		0.5	2.0	
Shutdown Supply Current	SHDN = GND, T _A = +25°C		1.0	10	µA	
LOGIC INPUTS AND RECEIVER OUTPUTS						
Input Logic Threshold Low (Note 3)	T _{IN} , $\overline{\text{EN}}$, $\overline{\text{SHDN}}$, MBAUD			0.8	V	
Input Logic Threshold High (Note 3)	V _{CC} = 3.3V	2.0			V	
	V _{CC} = 5.0V	2.4				
Input Leakage Current	T _{IN} , $\overline{\text{EN}}$, $\overline{\text{SHDN}}$, MBAUD		±0.01	±1.0	µA	
Output Leakage Current	Receivers disabled		±0.05	±10	µA	
Output Voltage Low	I _{OUT} = 1.6mA			0.4	V	
Output Voltage High	I _{OUT} = -1.0mA	V _{CC} - 0.6	V _{CC} - 0.1		V	
RECEIVER INPUTS						
Input Voltage Range		-25		25	V	
Input Threshold Low	T _A = +25°C	V _{CC} = 3.3V	0.6	1.2	V	
		V _{CC} = 5.0V	0.8	1.5		
Input Threshold High	T _A = +25°C	V _{CC} = 3.3V	1.5	2.4	V	
		V _{CC} = 5.0V	1.8	2.4		

3.0V to 5.5V, Low-Power, up to 1Mbps, True RS-232 Transceivers Using Four 0.1 μ F External Capacitors

ELECTRICAL CHARACTERISTICS (continued)

($V_{CC} = +3.0V$ to $+5.5V$, $C1-C4 = 0.1\mu F$ (Note 2), $T_A = T_{MIN}$ to T_{MAX} , unless otherwise noted. Typical values are at $T_A = +25^\circ C$.)

PARAMETER	CONDITIONS	MIN	TYP	MAX	UNITS
Input Hysteresis			0.3		V
Input Resistance	$T_A = +25^\circ C$	3	5	7	k Ω
TRANSMITTER OUTPUTS					
Output Voltage Swing	All transmitter outputs loaded with 3k Ω to ground	± 5.0	± 5.4		V
Output Resistance	$V_{CC} = V_+ = V_- = 0V$, $T_{OUT} = \pm 2V$	300	10M		Ω
Output Short-Circuit Current			± 35	± 60	mA
Output Leakage Current	$V_{OUT} = \pm 12V$, $V_{CC} = 0V$ or 3V to 5.5V, transmitters disabled			± 25	μA
MOUSE DRIVEABILITY (MAX3241)					
Transmitter Output Voltage	$T1IN = T2IN = GND$, $T3IN = V_{CC}$, $T3OUT$ loaded with 3k Ω to GND, $T1OUT$ and $T2OUT$ loaded with 2.5mA each	± 5.0			V

TIMING CHARACTERISTICS—MAX3222/MAX3232/MAX3241

($V_{CC} = +3.0V$ to $+5.5V$, $C1-C4 = 0.1\mu F$ (Note 2), $T_A = T_{MIN}$ to T_{MAX} , unless otherwise noted. Typical values are at $T_A = +25^\circ C$.)

PARAMETER	CONDITIONS	MIN	TYP	MAX	UNITS
Maximum Data Rate	$R_L = 3k\Omega$, $C_L = 1000pF$, one transmitter switching	120	235		kbps
Receiver Propagation Delay	R_{IN} to R_{OUT} , $C_L = 150pF$	t_{PHL}	0.3		μs
		t_{PLH}	0.3		
Receiver Output Enable Time	Normal operation		200		ns
Receiver Output Disable Time	Normal operation		200		ns
Transmitter Skew	$ t_{PHL} - t_{PLH} $		300		ns
Receiver Skew	$ t_{PHL} - t_{PLH} $		300		ns
Transition-Region Slew Rate	$V_{CC} = 3.3V$, $R_L = 3k\Omega$ to 7k Ω , $+3V$ to $-3V$ or $-3V$ to $+3V$, $T_A = +25^\circ C$, one transmitter switching	$C_L = 150pF$ to 1000pF	6	30	V/ μs
		$C_L = 150pF$ to 2500pF	4	30	

3.0V to 5.5V, Low-Power, up to 1Mbps, True RS-232 Transceivers Using Four 0.1µF External Capacitors

TIMING CHARACTERISTICS—MAX3237

(V_{CC} = +3.0V to +5.5V, C₁–C₄ = 0.1µF (Note 2), T_A = T_{MIN} to T_{MAX}, unless otherwise noted. Typical values are at T_A = +25°C.)

PARAMETER	CONDITIONS		MIN	TYP	MAX	UNITS
Maximum Data Rate	R _L = 3kΩ, C _L = 1000pF, one transmitter switching, MBAUD = GND		250			kbps
	V _{CC} = 3.0V to 4.5V, R _L = 3kΩ, C _L = 250pF, one transmitter switching, MBAUD = V _{CC}		1000			
	V _{CC} = 4.5V to 5.5V, R _L = 3kΩ, C _L = 1000pF, one transmitter switching, MBAUD = V _{CC}		1000			
Receiver Propagation Delay	R _{IN} to R _{OUT} , C _L = 150pF	t _{PHL}	0.15		µs	
		t _{PLH}	0.15			
Receiver Output Enable Time	Normal operation		200		ns	
Receiver Output Disable Time	Normal operation		200		ns	
Transmitter Skew	t _{PHL} - t _{PLH} , MBAUD = GND		100		ns	
	t _{PHL} - t _{PLH} , MBAUD = V _{CC}		25		ns	
Receiver Skew	t _{PHL} - t _{PLH}		50		ns	
Transition-Region Slew Rate	V _{CC} = 3.3V, R _L = 3Ω to 7kΩ, +3V to -3V or -3V to +3V, T _A = +25°C	C _L = 150pF to 1000pF, MBAUD = GND	6	30		V/µs
		C _L = 150pF to 1000pF, MBAUD = V _{CC}	24	150		
		C _L = 150pF to 2500pF, MBAUD = GND	4	30		

Note 2: MAX3222/MAX3232/MAX3241: C₁–C₄ = 0.1µF tested at 3.3V ±10%; C₁ = 0.047µF, C₂–C₄ = 0.33µF tested at 5.0V ±10%. MAX3237: C₁–C₄ = 0.1µF tested at 3.3V ±5%; C₁–C₄ = 0.22µF tested at 3.3V ±10%; C₁ = 0.047µF, C₂–C₄ = 0.33µF tested at 5.0V ±10%.

Note 3: Transmitter input hysteresis is typically 250mV.

Typical Operating Characteristics

(V_{CC} = +3.3V, 235kbps data rate, 0.1µF capacitors, all transmitters loaded with 3kΩ, T_A = +25°C, unless otherwise noted.)

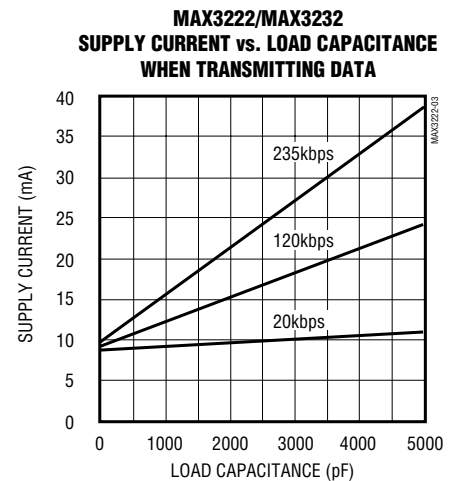
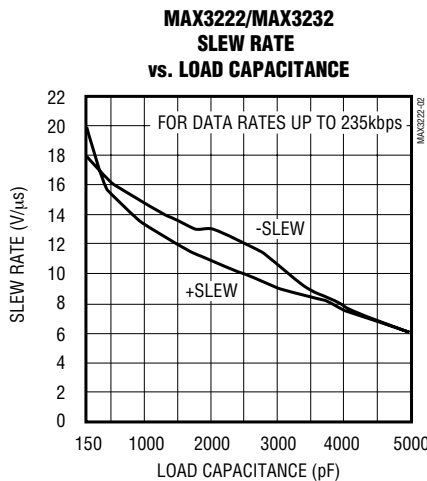
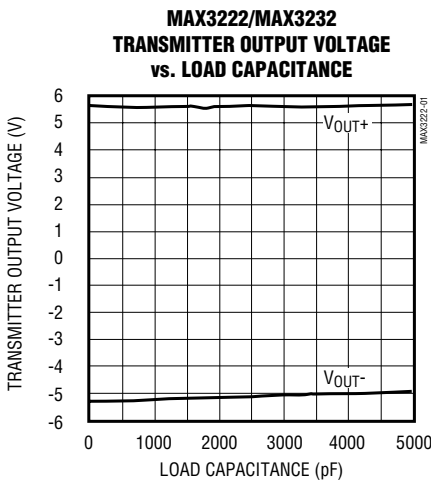

3.0V to 5.5V, Low-Power, up to 1Mbps, True RS-232 Transceivers Using Four 0.1μF External Capacitors

Typical Operating Characteristics (continued)

(V_{CC} = +3.3V, 235kbps data rate, 0.1μF capacitors, all transmitters loaded with 3kΩ, T_A = +25°C, unless otherwise noted.)

MAX3222/MAX3232/MAX3237/MAX3241

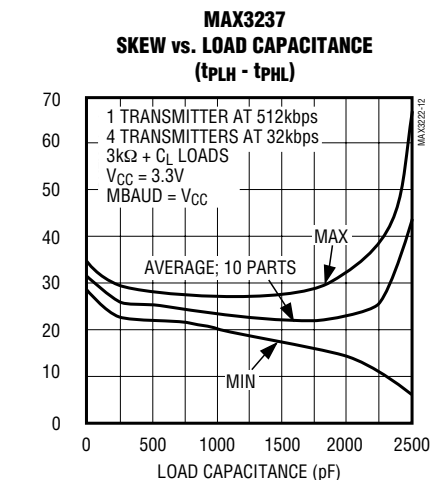
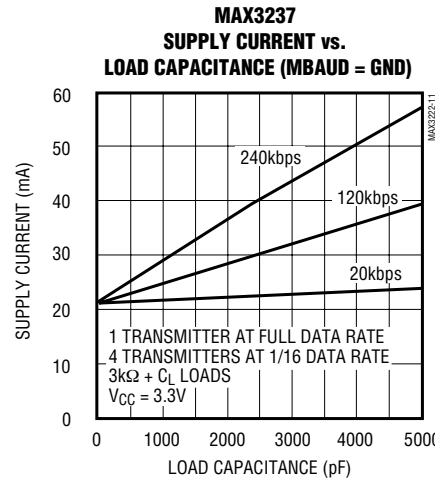
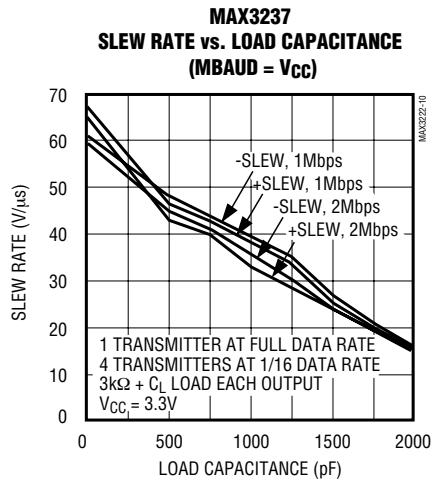
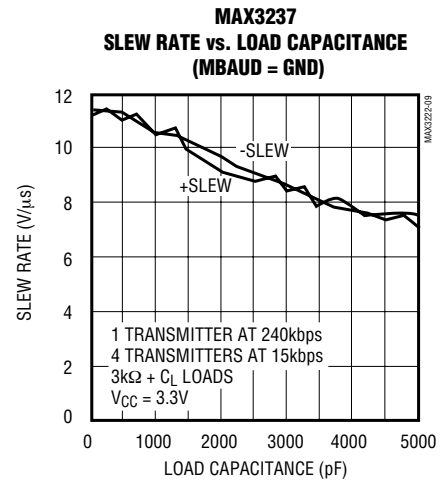
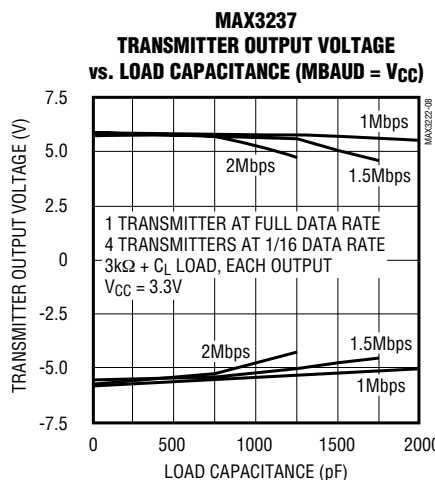
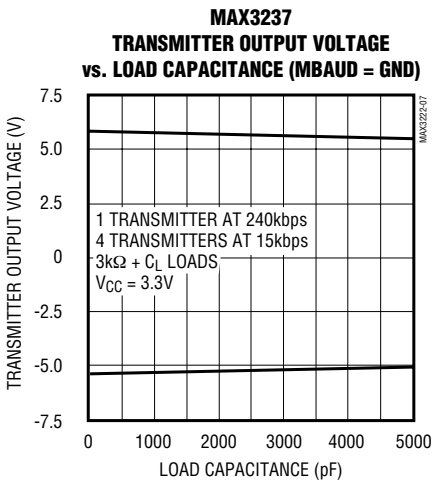
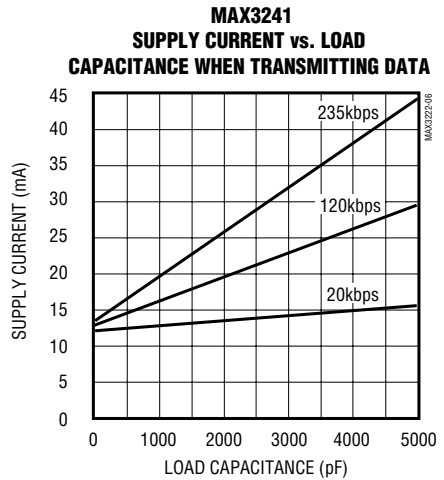
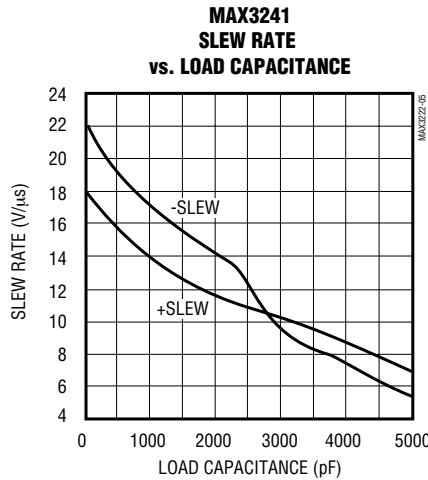
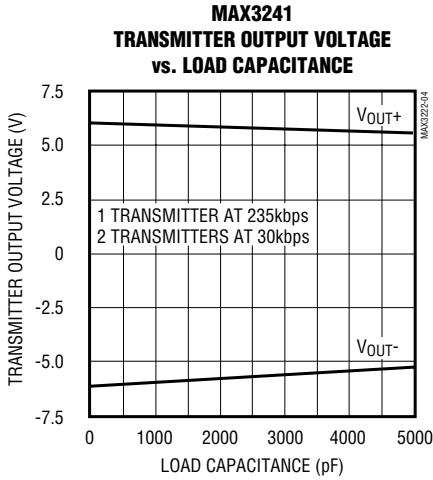

3.0V to 5.5V, Low-Power, up to 1Mbps, True RS-232 Transceivers Using Four 0.1µF External Capacitors

Pin Description

		PIN			NAME	FUNCTION
MAX3222		MAX3232	MAX3237	MAX3241		
DIP/SO	SSOP					
1	1	—	13	23	\overline{EN}	Receiver Enable. Active low.
2	2	1	28	28	C1+	Positive Terminal of Voltage-Doubler Charge-Pump Capacitor
3	3	2	27	27	V+	+5.5V Generated by the Charge Pump
4	4	3	25	24	C1-	Negative Terminal of Voltage-Doubler Charge-Pump Capacitor
5	5	4	1	1	C2+	Positive Terminal of Inverting Charge-Pump Capacitor
6	6	5	3	2	C2-	Negative Terminal of Inverting Charge-Pump Capacitor
7	7	6	4	3	V-	-5.5V Generated by the Charge Pump
8, 15	8, 17	7, 14	5, 6, 7, 10, 12	9, 10, 11	T_OUT	RS-232 Transmitter Outputs
9, 14	9, 16	8, 13	8, 9, 11	4–8	R_IN	RS-232 Receiver Inputs
10, 13	10, 15	9, 12	18, 20, 21	15–19	R_OUT	TTL/CMOS Receiver Outputs
11, 12	12, 13	10, 11	17, 19, 22, 23, 24	12, 13, 14	T_IN	TTL/CMOS Transmitter Inputs
16	18	15	2	25	GND	Ground
17	19	16	26	26	V _{CC}	+3.0V to +5.5V Supply Voltage
18	20	—	14	22	\overline{SHDN}	Shutdown Control. Active low.
—	11, 14	—	—	—	N.C.	No Connection
—	—	—	15	—	MBAUD	MegaBaud Control Input. Connect to GND for normal operation; connect to V _{CC} for 1Mbps transmission rates.
—	—	—	16	20, 21	R_OUTB	Noninverting Complementary Receiver Outputs. Always active.

MAX3222/MAX3232/MAX3237/MAX3241

3.0V to 5.5V, Low-Power, up to 1Mbps, True RS-232 Transceivers Using Four 0.1µF External Capacitors

Detailed Description

Dual Charge-Pump Voltage Converter

The MAX3222/MAX3232/MAX3237/MAX3241's internal power supply consists of a regulated dual charge pump that provides output voltages of +5.5V (doubling charge pump) and -5.5V (inverting charge pump), regardless of the input voltage (V_{CC}) over the 3.0V to 5.5V range. The charge pumps operate in a discontinuous mode; if the output voltages are less than 5.5V, the charge pumps are enabled, and if the output voltages exceed 5.5V, the charge pumps are disabled. Each charge pump requires a flying capacitor (C1, C2) and a reservoir capacitor (C3, C4) to generate the $V+$ and $V-$ supplies.

RS-232 Transmitters

The transmitters are inverting level translators that convert CMOS-logic levels to 5.0V EIA/TIA-232 levels.

The MAX3222/MAX3232/MAX3241 transmitters guarantee a 120kbps data rate with worst-case loads of $3k\Omega$ in parallel with 1000pF, providing compatibility with PC-to-PC communication software (such as LapLink™). Typically, these three devices can operate at data rates of 235kbps. Transmitters can be paralleled to drive multiple receivers or mice.

The MAX3222/MAX3237/MAX3241's output stage is turned off (high impedance) when the device is in shutdown mode. When the power is off, the MAX3222/MAX3232/MAX3237/MAX3241 permit the outputs to be driven up to $\pm 12V$.

The transmitter inputs do not have pullup resistors. Connect unused inputs to GND or V_{CC} .

MAX3237 MegaBaud Operation

In normal operating mode ($MBAUD = GND$), the MAX3237 transmitters guarantee a 250kbps data rate with worst-case loads of $3k\Omega$ in parallel with 1000pF. This provides compatibility with PC-to-PC communication software, such as Laplink™.

For higher speed serial communications, the MAX3237 features MegaBaud operation. In MegaBaud operating mode ($MBAUD = V_{CC}$), the MAX3237 transmitters guarantee a 1Mbps data rate with worst-case loads of $3k\Omega$ in parallel with 250pF for $3.0V < V_{CC} < 4.5V$. For $5V \pm 10\%$ operation, the MAX3237 transmitters guarantee a 1Mbps data rate into worst-case loads of $3k\Omega$ in parallel with 1000pF.

LapLink is a trademark of Traveling Software.

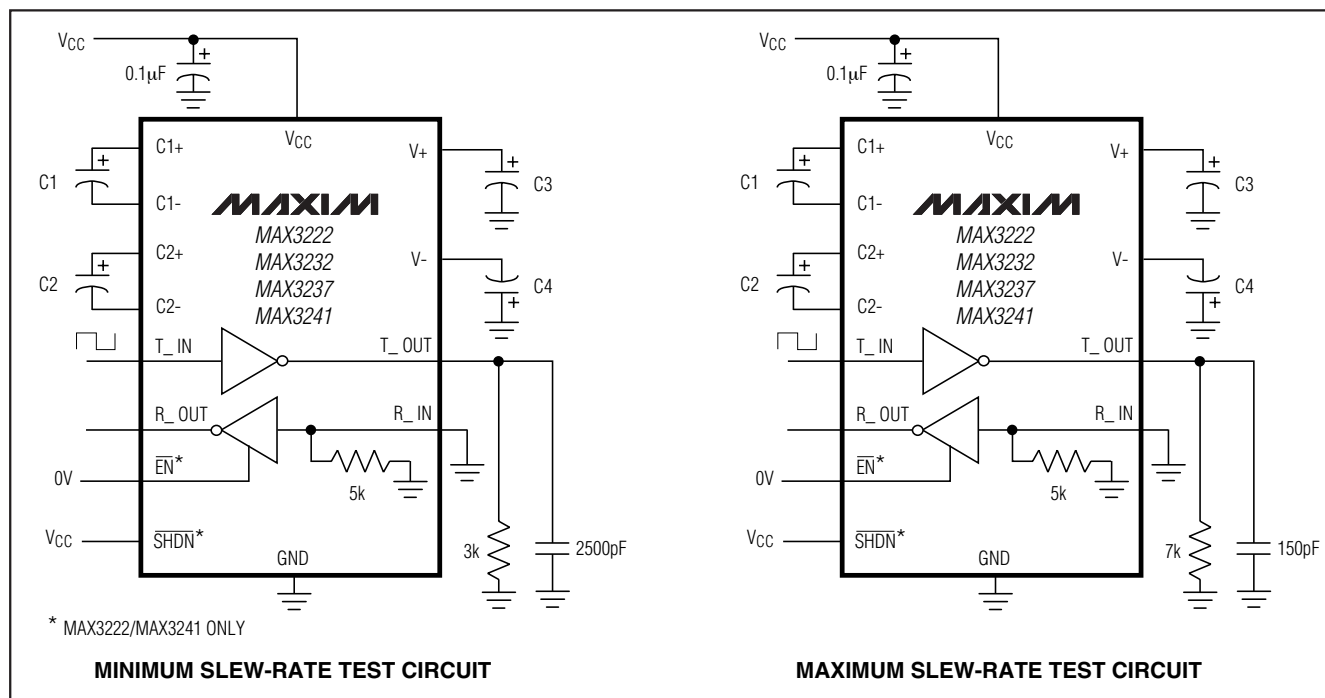

Figure 1. Slew-Rate Test Circuits

3.0V to 5.5V, Low-Power, up to 1Mbps, True RS-232 Transceivers Using Four 0.1µF External Capacitors

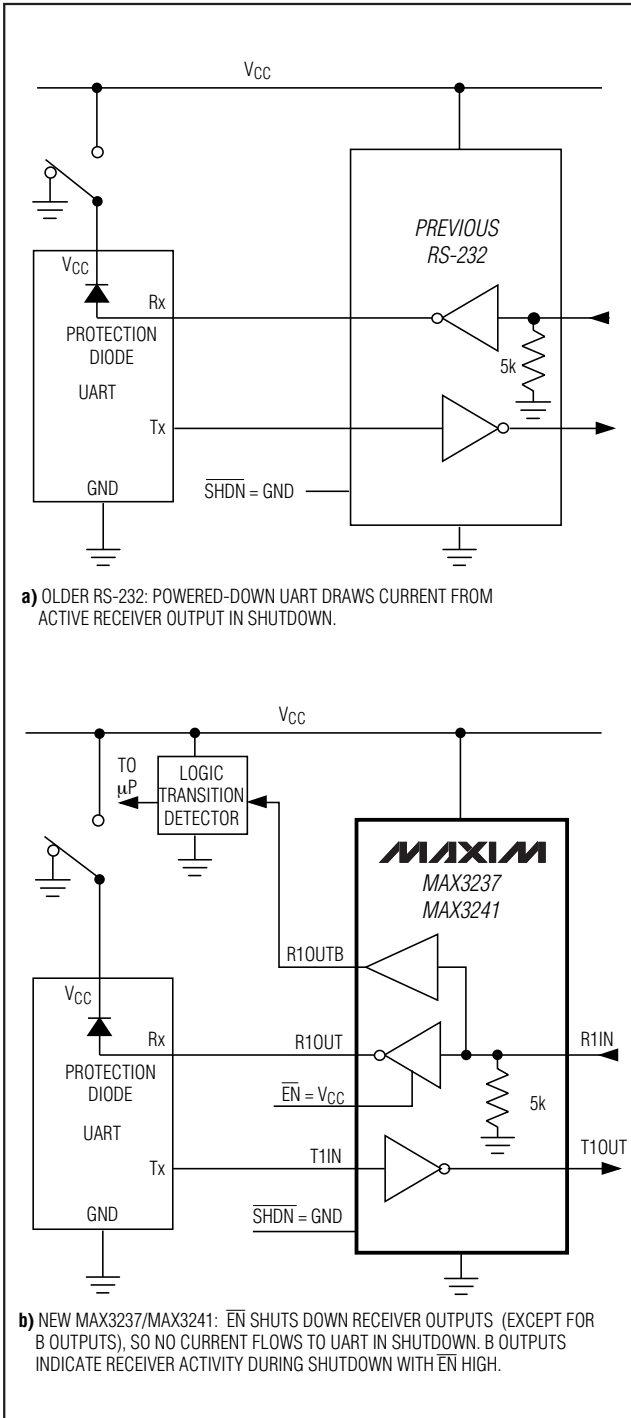

Figure 2. Detection of RS-232 Activity when the UART and Interface are Shut Down; Comparison of MAX3237/MAX3241 (b) with Previous Transceivers (a).

RS-232 Receivers

The receivers convert RS-232 signals to CMOS-logic output levels. The MAX3222/MAX3237/MAX3241 receivers have inverting three-state outputs. In shutdown, the receivers can be active or inactive (Table 1).

The complementary outputs on the MAX3237 (R1OUTB) and the MAX3241 (R1OUTB, R2OUTB) are always active, regardless of the state of $\overline{\text{EN}}$ or $\overline{\text{SHDN}}$. This allows for Ring Indicator applications without forward biasing other devices connected to the receiver outputs. This is ideal for systems where V_{CC} is set to 0V in shutdown to accommodate peripherals, such as UARTs (Figure 2).

MAX3222/MAX3237/MAX3241 Shutdown Mode

Supply current falls to less than 1µA in shutdown mode ($\overline{\text{SHDN}}$ = low). When shut down, the device's charge pumps are turned off, V₊ is pulled down to V_{CC}, V₋ is pulled to ground, and the transmitter outputs are disabled (high impedance). The time required to exit shutdown is typically 100µs, as shown in Figure 3. Connect $\overline{\text{SHDN}}$ to V_{CC} if the shutdown mode is not used. $\overline{\text{SHDN}}$ has no effect on R₋OUT or R₋OUTB.

MAX3222/MAX3237/MAX3241 Enable Control

The inverting receiver outputs (R₋OUT) are put into a high-impedance state when $\overline{\text{EN}}$ is high. The complementary outputs R1OUTB and R2OUTB are always active, regardless of the state of $\overline{\text{EN}}$ and $\overline{\text{SHDN}}$ (Table 1). $\overline{\text{EN}}$ has no effect on T₋OUT.

Applications Information

Capacitor Selection

The capacitor type used for C1–C4 is not critical for proper operation; polarized or nonpolarized capacitors can be used. The charge pump requires 0.1µF capacitors for 3.3V operation. For other supply voltages, refer to Table 2 for required capacitor values. Do not use values lower than those listed in Table 2. Increasing the capacitor values (e.g., by a factor of 2) reduces ripple on the transmitter outputs and slightly reduces power consumption. C2, C3, and C4 can be increased without changing C1's value. However, do not increase C1 without also increasing the values of C2, C3, and C4, to maintain the proper ratios (C1 to the other capacitors).

When using the minimum required capacitor values, make sure the capacitor value does not degrade excessively with temperature. If in doubt, use capacitors with a higher nominal value. The capacitor's equivalent series resistance (ESR), which usually rises at low temperatures, influences the amount of ripple on V₊ and V₋.

3.0V to 5.5V, Low-Power, up to 1Mbps, True RS-232 Transceivers Using Four 0.1µF External Capacitors

Table 1. MAX3222/MAX3237/MAX3241 Shutdown and Enable Control Truth Table

SHDN	EN	T_OUT	R_OUT	R_OUTB (MAX3237/MAX3241)
0	0	High-Z	Active	Active
0	1	High-Z	High-Z	Active
1	0	Active	Active	Active
1	1	Active	High-Z	Active

Table 2. Required Minimum Capacitor Values

V _{CC} (V)	C1 (µF)	C2, C3, C4 (µF)
MAX3222/MAX3232/MAX3241		
3.0 to 3.6	0.1	0.1
4.5 to 5.5	0.047	0.33
3.0 to 5.5	0.1	0.47
MAX3237		
3.0 to 3.6	0.22	0.22
3.15 to 3.6	0.1	0.1
4.5 to 5.5	0.047	0.33
3.0 to 5.5	0.22	1.0

Power-Supply Decoupling

In most circumstances, a 0.1µF bypass capacitor is adequate. In applications that are sensitive to power-supply noise, decouple V_{CC} to ground with a capacitor of the same value as charge-pump capacitor C1. Connect bypass capacitors as close to the IC as possible.

Operation Down to 2.7V

Transmitter outputs will meet EIA/TIA-562 levels of ±3.7V with supply voltages as low as 2.7V.

Transmitter Outputs when Exiting Shutdown

Figure 3 shows two transmitter outputs when exiting shutdown mode. As they become active, the two transmitter outputs are shown going to opposite RS-232 levels (one transmitter input is high, the other is low). Each transmitter is loaded with 3kΩ in parallel with 2500pF. The transmitter outputs display no ringing or undesirable transients as they come out of shutdown. Note that the transmitters are enabled only when the magnitude of V₋ exceeds approximately 3V.

Mouse Driveability

The MAX3241 has been specifically designed to power serial mice while operating from low-voltage power supplies. It has been tested with leading mouse brands from manufacturers such as Microsoft and Logitech. The MAX3241 successfully drove all serial mice tested and met their respective current and voltage requirements. Figure 4a shows the transmitter output voltages under increasing load current at 3.0V. Figure 4b shows a typical mouse connection using the MAX3241.

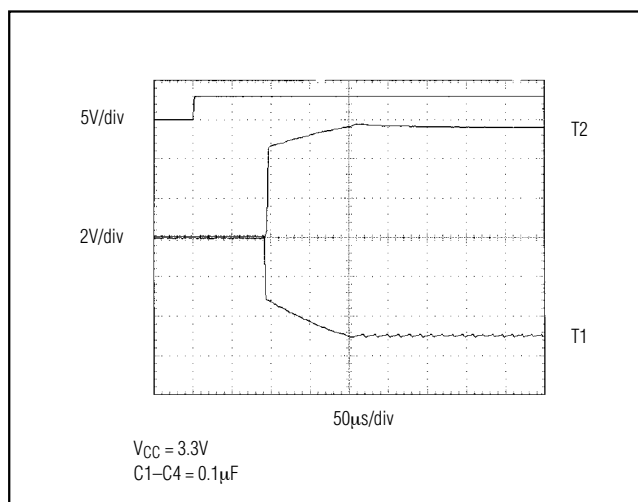

Figure 3. Transmitter Outputs when Exiting Shutdown or Powering Up

3.0V to 5.5V, Low-Power, up to 1Mbps, True RS-232 Transceivers Using Four 0.1µF External Capacitors

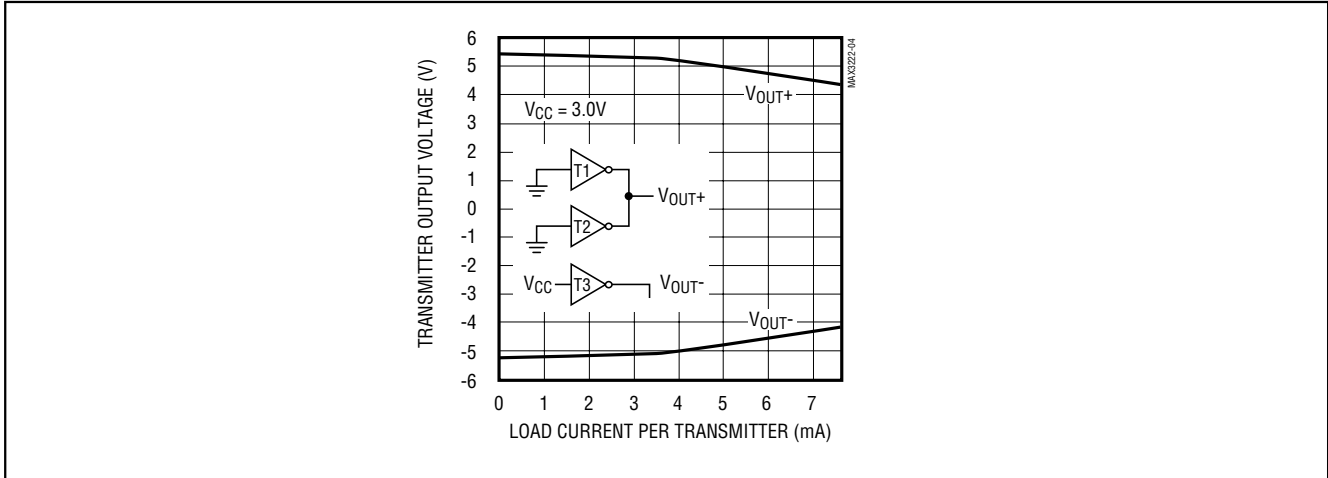

Figure 4a. MAX3241 Transmitter Output Voltage vs. Load Current per Transmitter

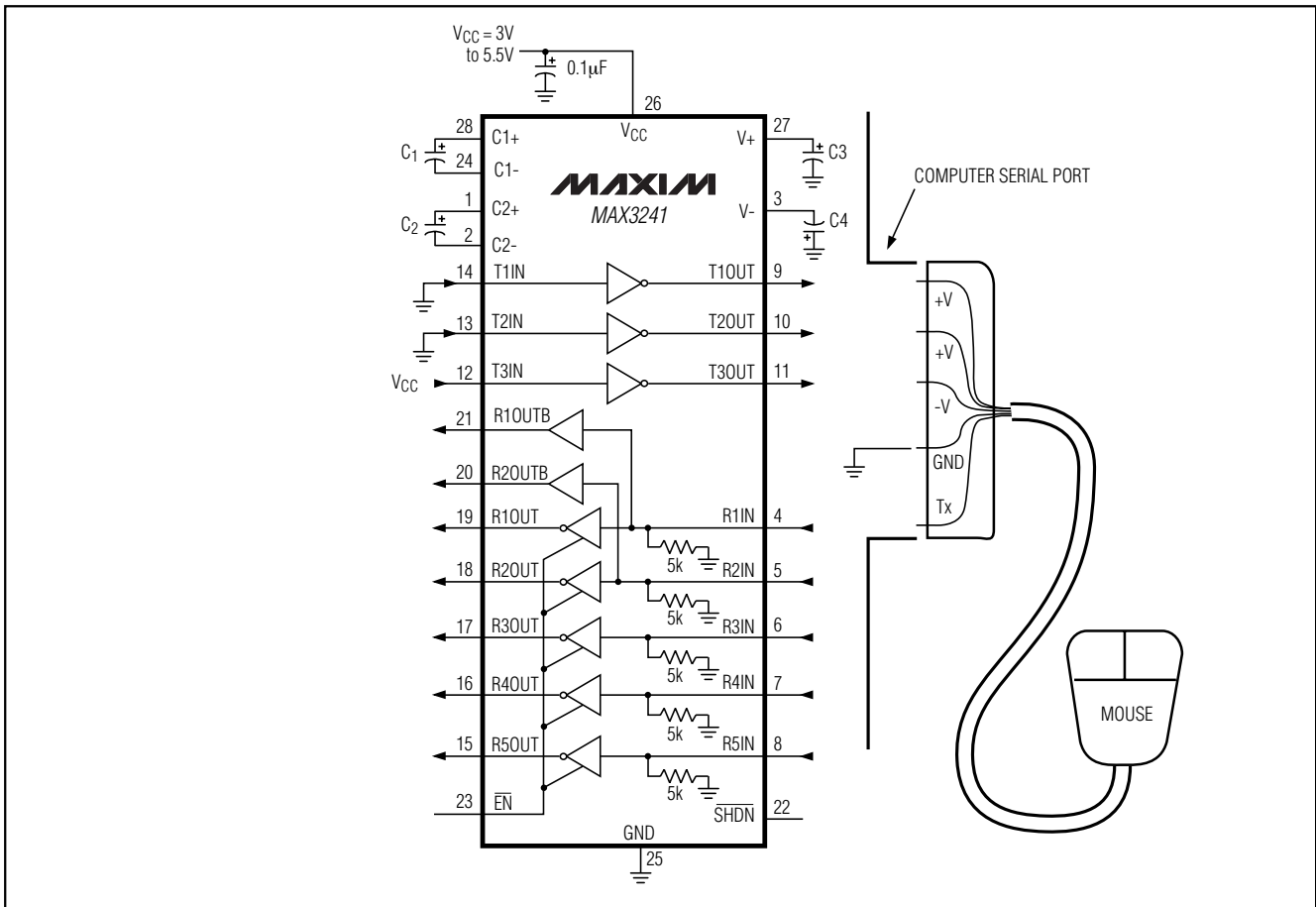

Figure 4b. Mouse Driver Test Circuit

3.0V to 5.5V, Low-Power, up to 1Mbps, True RS-232 Transceivers Using Four 0.1µF External Capacitors

MAX3222/MAX3232/MAX3237/MAX3241

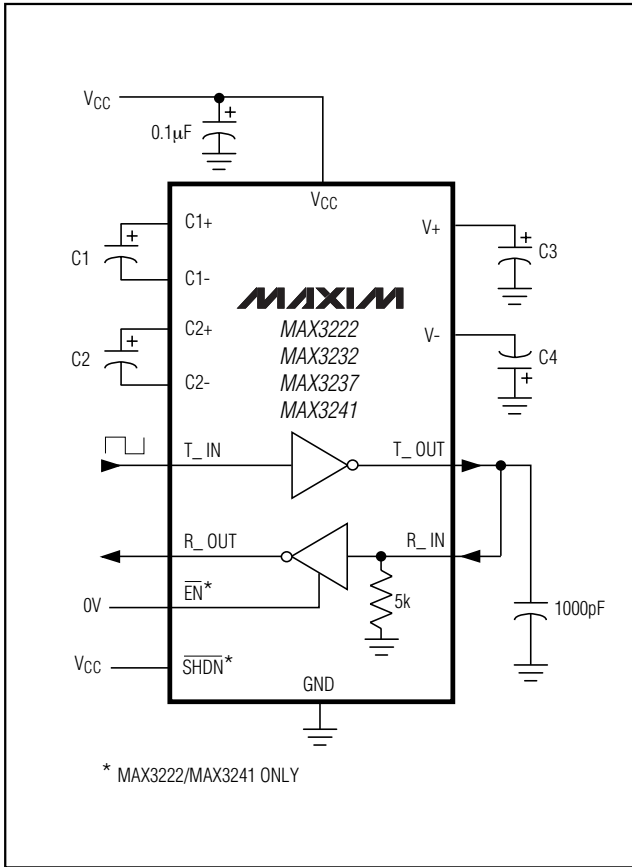

Figure 5. Loopback Test Circuit

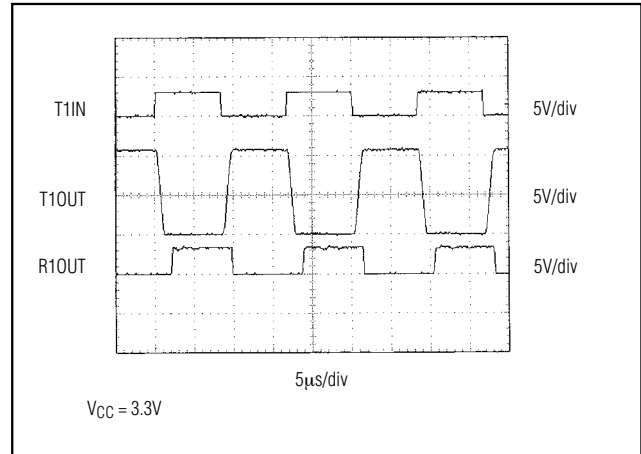

Figure 6. MAX3241 Loopback Test Result at 120kbps

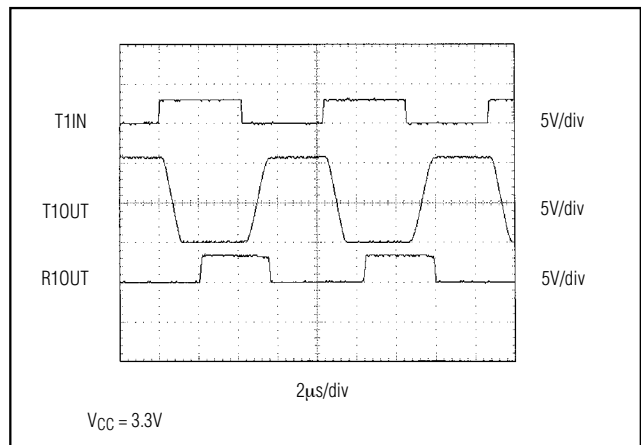

Figure 7. MAX3241 Loopback Test Result at 235kbps

High Data Rates

The MAX3222/MAX3232/MAX3241 maintain the RS-232 $\pm 5.0V$ minimum transmitter output voltage even at high data rates. Figure 5 shows a transmitter loopback test circuit. Figure 6 shows a loopback test result at 120kbps, and Figure 7 shows the same test at 235kbps. For Figure 6, all transmitters were driven simultaneously at 120kbps into RS-232 loads in parallel with 1000pF. For Figure 7, a single transmitter was driven at 235kbps, and all transmitters were loaded with an RS-232 receiver in parallel with 1000pF.

The MAX3237 maintains the RS-232 $\pm 5.0V$ minimum transmitter output voltage at data rates up to 1Mbps. Figure 8 shows a loopback test result at 1000kbps with MBAUD = VCC. For Figure 8, all transmitters were loaded with an RS-232 receiver in parallel with 250pF.

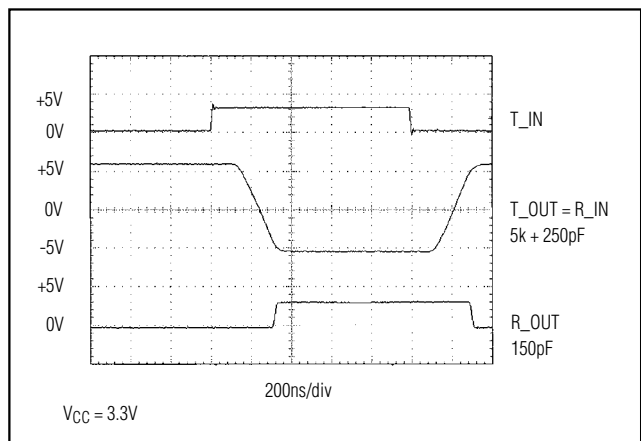

Figure 8. MAX3237 Loopback Test Result at 1000kbps (MBAUD = VCC)

3.0V to 5.5V, Low-Power, up to 1Mbps, True RS-232 Transceivers Using Four 0.1µF External Capacitors

Interconnection with 3V and 5V Logic

The MAX3222/MAX3232/MAX3237/MAX3241 can directly interface with various 5V logic families, including ACT and HCT CMOS. See Table 3 for more information on possible combinations of interconnections.

Table 3. Logic-Family Compatibility with Various Supply Voltages

SYSTEM POWER-SUPPLY VOLTAGE (V)	MAX32_ _ V _{CC} SUPPLY VOLTAGE (V)	COMPATIBILITY
3.3	3.3	Compatible with all CMOS families.
5	5	Compatible with all TTL and CMOS-logic families.
5	3.3	Compatible with ACT and HCT CMOS, and with TTL. Incompatible with AC, HC, and CD4000 CMOS.

Typical Operating Circuits

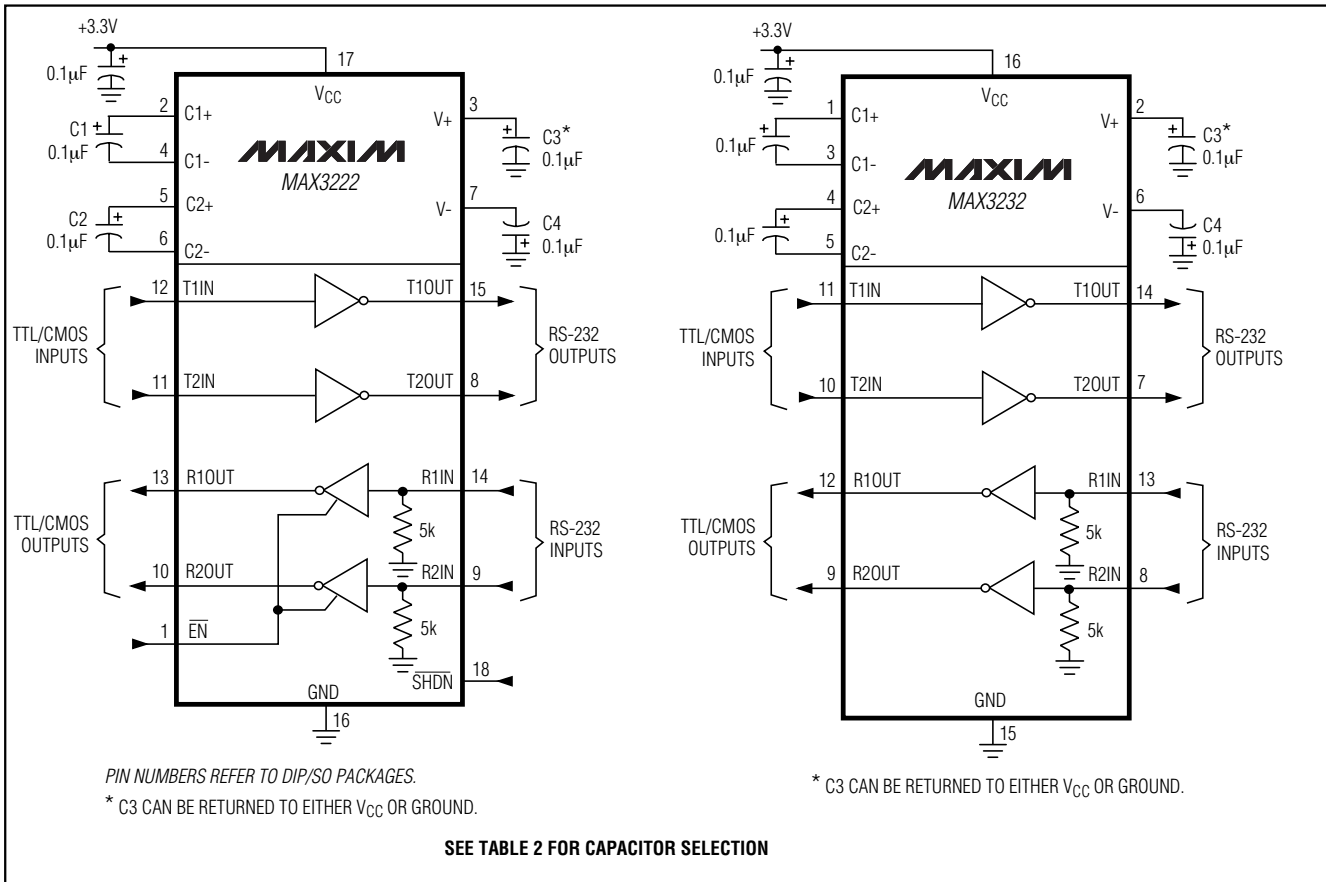

3.0V to 5.5V, Low-Power, up to 1Mbps, True RS-232 Transceivers Using Four 0.1µF External Capacitors

Typical Operating Circuits (continued)

MAX3222/MAX3232/MAX3237/MAX3241

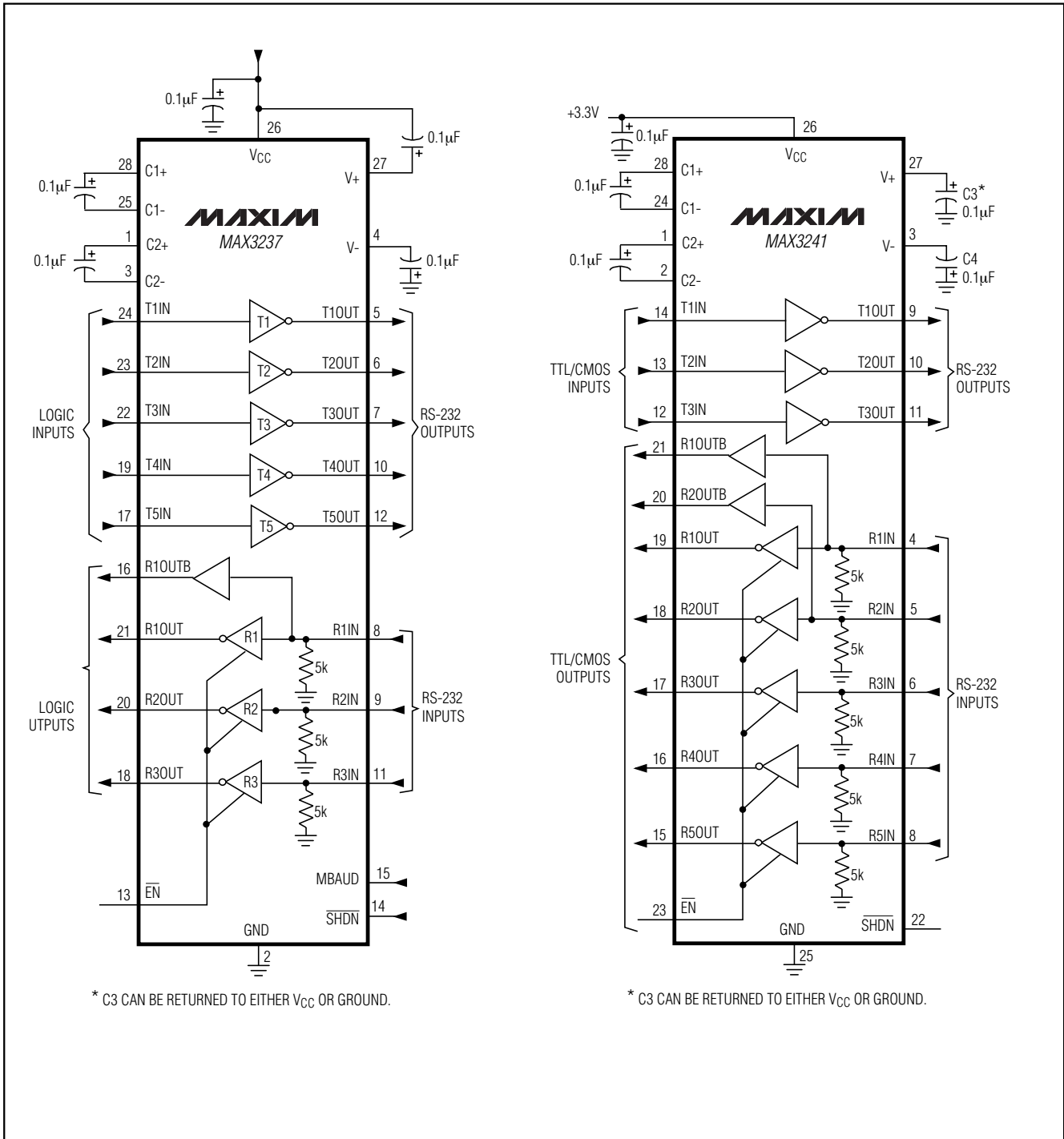

3.0V to 5.5V, Low-Power, up to 1Mbps, True RS-232 Transceivers Using Four 0.1µF External Capacitors

Pin Configurations (continued)

TOP VIEW

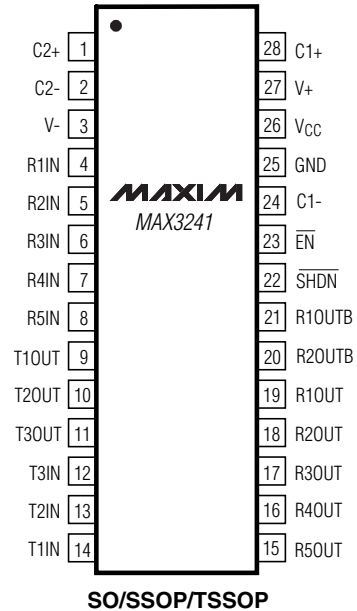
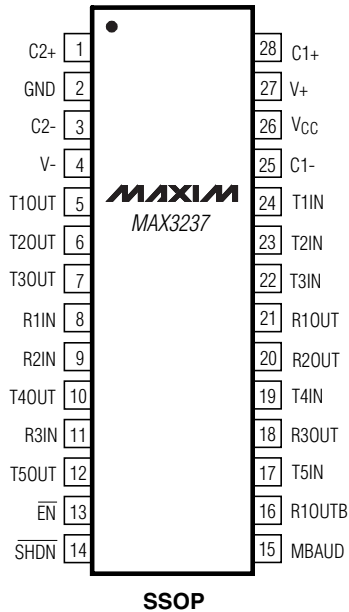
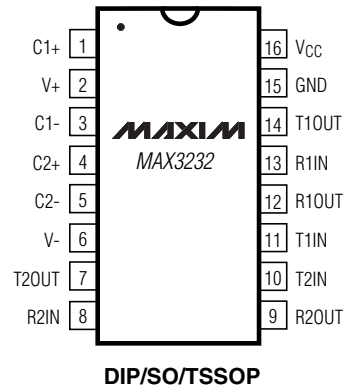
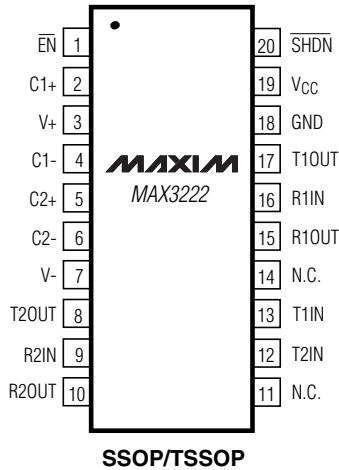

3.0V to 5.5V, Low-Power, up to 1Mbps, True RS-232 Transceivers Using Four 0.1µF External Capacitors

Ordering Information (continued)

PART	TEMP RANGE	PIN-PACKAGE
MAX3222EUP	-40°C to +85°C	20 TSSOP
MAX3222EAP	-40°C to +85°C	20 SSOP
MAX3222EWN	-40°C to +85°C	18 SO
MAX3222EPN	-40°C to +85°C	18 Plastic DIP
MAX3222C/D	0°C to +70°C	Dice*
MAX3232CUE	0°C to +70°C	16 TSSOP
MAX3232CSE	0°C to +70°C	16 Narrow SO
MAX3232CWE	0°C to +70°C	16 Wide SO
MAX3232CPE	0°C to +70°C	16 Plastic DIP
MAX3232EUE	-40°C to +85°C	16 TSSOP
MAX3232ESE	-40°C to +85°C	16 Narrow SO

PART	TEMP RANGE	PIN-PACKAGE
MAX3232EWE	-40°C to +85°C	16 Wide SO
MAX3232EPE	-40°C to +85°C	16 Plastic DIP
MAX3237CAI	0°C to +70°C	28 SSOP
MAX3237EAI	-40°C to +85°C	28 SSOP
MAX3241CUI	0°C to +70°C	28 TSSOP
MAX3241CAI	0°C to +70°C	28 SSOP
MAX3241CWI	0°C to +70°C	28 SO
MAX3241EUI	-40°C to +85°C	28 TSSOP
MAX3241EAI	-40°C to +85°C	28 SSOP
MAX3241EWI	-40°C to +85°C	28 SO

* Dice are tested at $T_A = +25^\circ\text{C}$, DC parameters only.

3V-Powered EIA/TIA-232 and EIA/TIA-562 Transceivers from Maxim

PART	POWER-SUPPLY VOLTAGE (V)	No. OF TRANSMITTERS/RECEIVERS	No. OF RECEIVERS ACTIVE IN SHUTDOWN	GUARANTEED DATA RATE (kbps)	EIA/TIA-232 OR 562	FEATURES
MAX212	3.0 to 3.6	3/5	5	120	232	Drives mice
MAX218	1.8 to 4.25	2/2	2	120	232	Operates directly from batteries without a voltage regulator
MAX562	2.7 to 5.25	3/5	5	230	562	Wide supply range
MAX563	3.0 to 3.6	2/2	2	230	562	0.1µF capacitors
MAX3212	2.7 to 3.6	3/5	5	235	232	AutoShutdown, complementary receiver, drives mice, transient detection
MAX3222	3.0 to 5.5	2/2	2	120	232	0.1µF capacitors
MAX3223	3.0 to 5.5	2/2	2	120	232	0.1µF capacitors, AutoShutdown
MAX3232	3.0 to 5.5	2/2	N/A	120	232	0.1µF capacitors
MAX3237	3.0 to 5.5	5/3	3	250/1000	232	0.1µF capacitors, 1 complementary receiver, MegaBaud operation
MAX3241	3.0 to 5.5	3/5	5	120	232	0.1µF capacitors, 2 complementary receivers, drives mice
MAX3243	3.0 to 5.5	3/5	1	120	232	0.1µF capacitors, AutoShutdown, complementary receiver, drives mice

3.0V to 5.5V, Low-Power, up to 1Mbps, True RS-232 Transceivers Using Four 0.1µF External Capacitors

Chip Topography

Chip Information

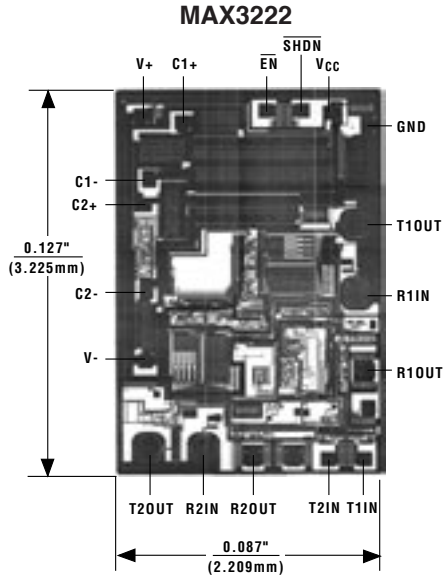

PART	TRANSISTOR COUNT
MAX3222	339
MAX3232	339
MAX3237	1212
MAX3241	894

TRANSISTOR COUNT: 339
SUBSTRATE CONNECTED TO GND

Package Information

(The package drawing(s) in this data sheet may not reflect the most current specifications. For the latest package outline information, go to www.maxim-ic.com/packages.)

TOP VIEW

BOTTOM VIEW

SIDE VIEW

END VIEW

DETAIL A

COMMON DIMENSIONS				
DIMENSION	MILLIMETERS		INCHES	
	MIN.	MAX.	MIN.	MAX.
A	—	1.10	—	.043
A ₁	0.05	0.15	.002	.006
A ₂	0.85	0.95	.033	.037
b	0.19	0.30	.007	.012
b ₁	0.19	0.25	.007	.010
c	0.09	0.20	.004	.008
c ₁	0.09	0.14	.004	.006
D	SEE VARIATIONS		SEE VARIATIONS	
E	4.30	4.50	.169	.177
E	0.65 BSC		.026 BSC	
H	6.25	6.55	.246	.258
L	0.50	0.70	.020	.028
N	SEE VARIATIONS		SEE VARIATIONS	
Ø	0*	Ø*	0*	Ø*

JEDEC	N	VARIATIONS			
		MILLIMETERS		INCHES	
		MIN.	MAX.	MIN.	MAX.
MD-153	N	—	—	—	—
AB-1	14	D	4.90	5.10	.193 .201
AB	16	D	4.90	5.10	.193 .201
AC	20	D	6.40	6.60	.252 .260
AD	24	D	7.70	7.90	.303 .311
AE	28	D	9.60	9.80	.378 .386

NOTES:

- DIMENSIONS D AND E DO NOT INCLUDE FLASH
- MOLD FLASH OR PROTRUSIONS NOT TO EXCEED 0.15mm PER SIDE
- CONTROLLING DIMENSION: MILLIMETER
- MEETS JEDEC OUTLINE MD-153. SEE JEDEC VARIATIONS TABLE
- "N" REFERS TO NUMBER OF LEADS

THE LEAD TIPS MUST LIE WITHIN A SPECIFIED ZONE. THIS TOLERANCE ZONE IS DEFINED BY TWO PARALLEL PLANES. ONE PLANE IS THE SEATING PLANE, DATUM [-C-]. THE OTHER PLANE IS AT THE SPECIFIED DISTANCE FROM [-C-] IN THE DIRECTION INDICATED.

DALLAS SEMICONDUCTOR **MAXIM**

PROPRIETARY INFORMATION

TITLE: PACKAGE OUTLINE, TSSOP 4.40mm BODY

APPROVAL: _____ DOCUMENT CONTROL NO: 21-0066 REV: 1/1

Maxim cannot assume responsibility for use of any circuitry other than circuitry entirely embodied in a Maxim product. No circuit patent licenses are implied. Maxim reserves the right to change the circuitry and specifications without notice at any time.

16 **Maxim Integrated Products, 120 San Gabriel Drive, Sunnyvale, CA 94086 408-737-7600**