



Technical Data Sheet - Preliminary

Top View LED with Bi-Color

67-22SURSYGC/S530-A3/E3/TR8

Features

- P-LCC-4 package.
- White package.
- Optical indicator.
- Colorless clear window.
- Ideal for backlight and light pipe application.
- Inter reflector.
- Wide viewing angle.
- Computable with automatic placement equipment.
- Available on tape and reel (8mm Tape).
- Pb-free
- The product itself will remain within RoHS compliant version.

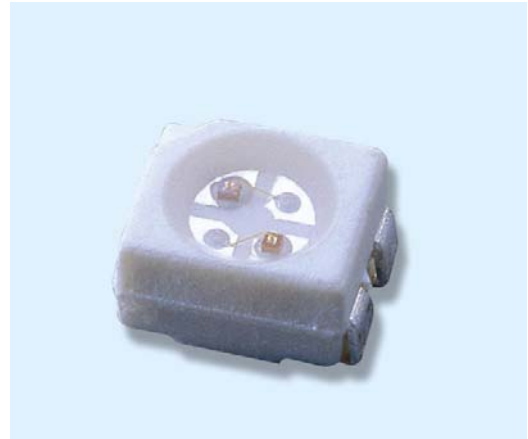

Descriptions

- The 67-22 series is available in soft orange, green, blue and yellow. Due to the package design, the LED has wide viewing angle and optimized light coupling by inter reflector, this feature makes the ideal for light pipe application. The low current requirement makes this device ideal for portable equipment or any other application where power is at a premium.

Applications

- Automotive: backlight in dashboards and switches.
- Telecommunication: indicator and backlight in telephone and fax.
- Indicator and backlight for audio and video equipment.
- Indicator and backlight in office and family equipment.
- Flat backlight for LCD's, switches and symbols.
- Light pipe application.
- General use.

Device Selection Guide

Chip		Emitted Color	Resin Color
Type	Material		
SUR	AlGaInP	Deep-Red	Water Clear
SYG	AlGaInP	Brilliant Yellow Green	

Technical Data Sheet - Preliminary

Top View LED with Bi-Color

67-22SURSYGC/S530-A3/E3/TR8

Package Dimensions

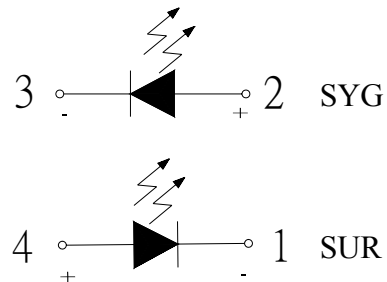
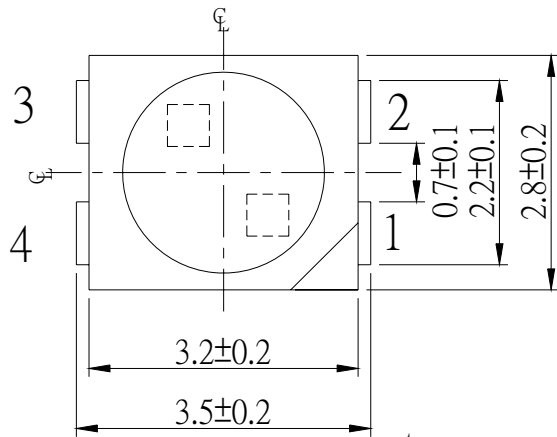

Polarity

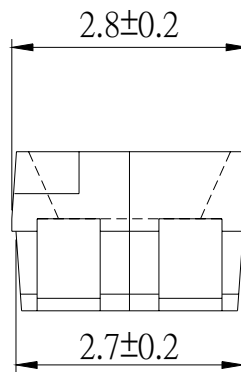
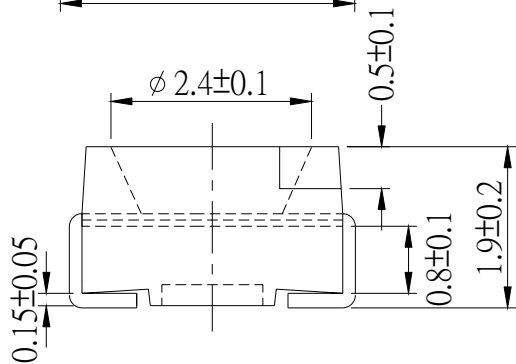

For reflow soldering(propose)

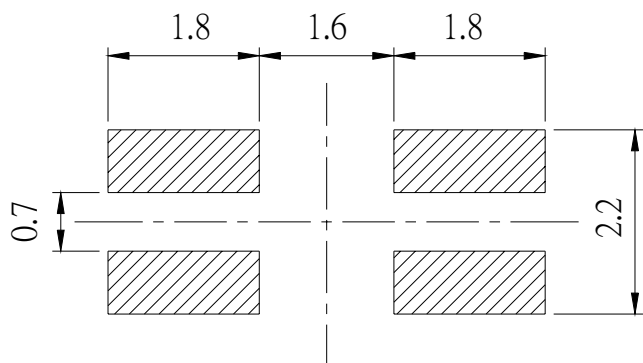
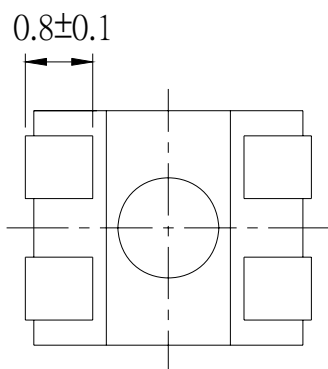

Notes: 1.All dimensions are in millimeters.

2.Tolerances unspecified are ± 0.1 mm.



Technical Data Sheet - Preliminary

Top View LED with Bi-Color

67-22SURSYGC/S530-A3/E3/TR8

Absolute Maximum Ratings (Ta=25°C)

Parameter	Symbol	Rating		Unit
Reverse Voltage	V _R	5		V
Forward Current	I _F	SUR	25	mA
		SYG	25	
Peak Forward Current (Duty 1/10 @1KHz)	I _{FP}	SUR	60	mA
		SYG	60	
Power Dissipation	Pd	SUR	60	mW
		SYG	60	
Electrostatic Discharge(HBM)	ESD	SUR	2000	V
		SYG	2000	
Operating Temperature	Topr	-40 ~ +85		°C
Storage Temperature	Tstg	-40~ +100		°C
Soldering Temperature	Tsol	Reflow Soldering : 260 °C for 10 sec. Hand Soldering : 350 °C for 3 sec.		

**Technical Data Sheet - Preliminary****Top View LED with Bi-Color****67-22SURSYGC/S530-A3/E3/TR8****Electro-Optical Characteristics (Ta=25°C)**

Parameter	Symbol	Min.	Typ.	Max.	Unit	Condition	
Luminous Intensity	I _v	SUR	57	90	-----	mcd	I _F =20mA
		SYG	28.5	45	-----	mcd	
Viewing Angle	2θ 1/2		-----	130	-----	deg	I _F =20mA
Peak Wavelength	λ _p	SUR	-----	632	-----	nm	I _F =20mA
		SYG	-----	575	-----		
Dominant Wavelength	λ _d	SUR	-----	624	-----	nm	I _F =20mA
		SYG	-----	573	-----		
Spectrum Radiation Bandwidth	Δλ	SUR	-----	20	-----	nm	I _F =20mA
		SYG	-----	20	-----		
Forward Voltage	V _F	SUR	1.7	2.0	2.4	V	I _F =20mA
		SYG	1.7	2.0	2.4		
Reverse Current	I _R	-----	-----	10	μA	V _R =5V	



Technical Data Sheet - Preliminary

Top View LED with Bi-Color

67-22SURSYGC/S530-A3/E3/TR8

Typical Electro-Optical Characteristics Curves (SUR)

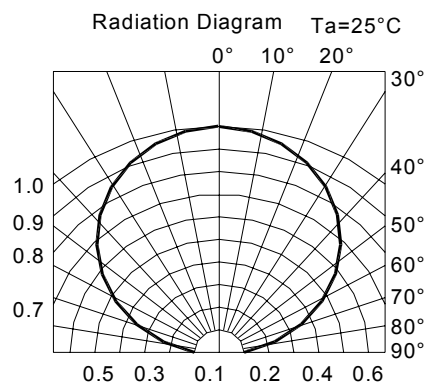
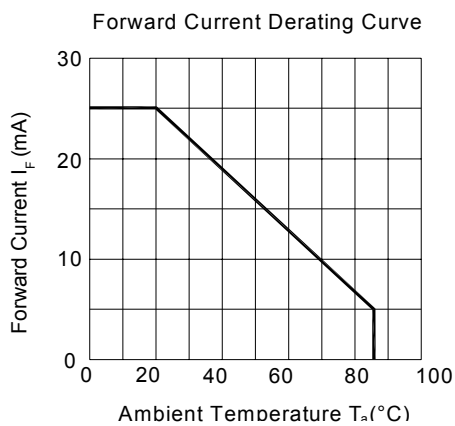
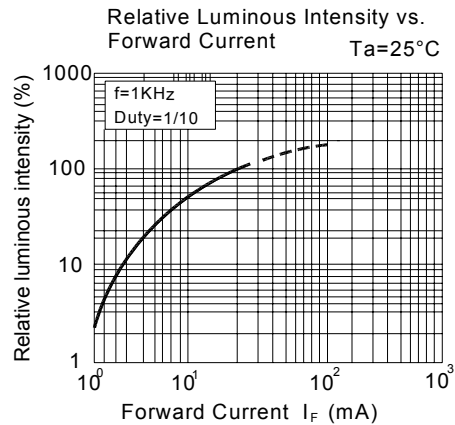
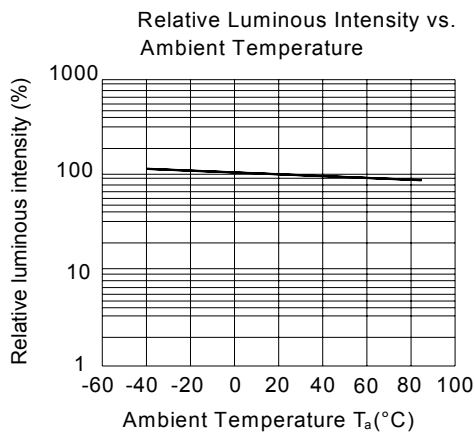
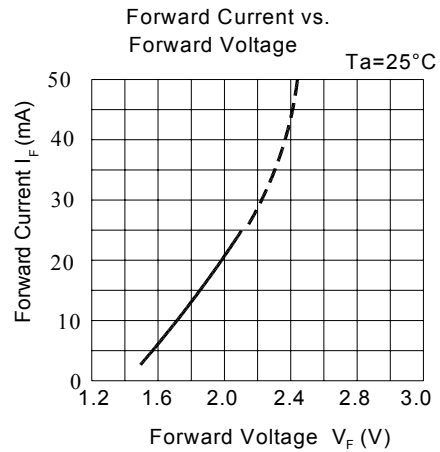
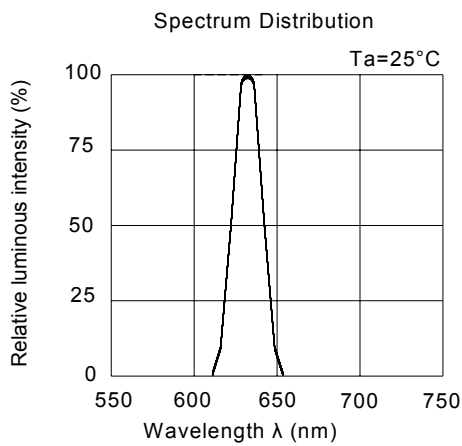



Technical Data Sheet - Preliminary

Top View LED with Bi-Color

67-22SURSYGC/S530-A3/E3/TR8

Typical Electro-Optical Characteristics Curves (SYG)

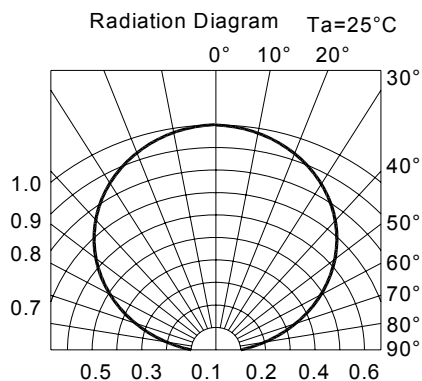
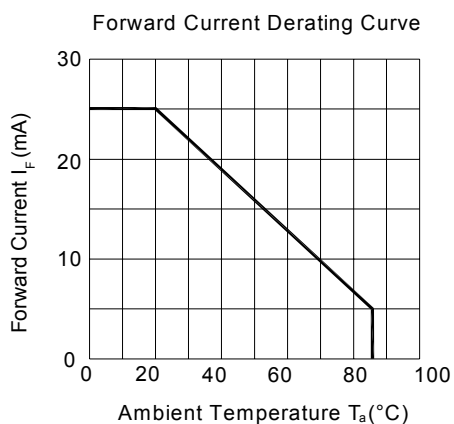
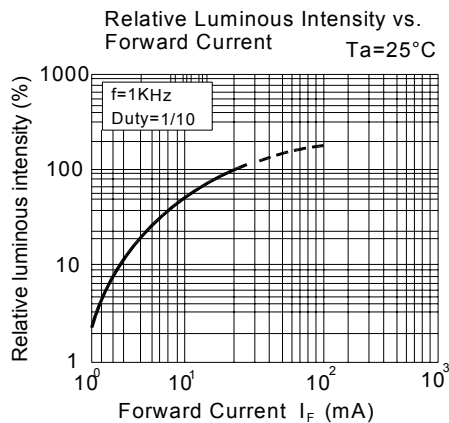
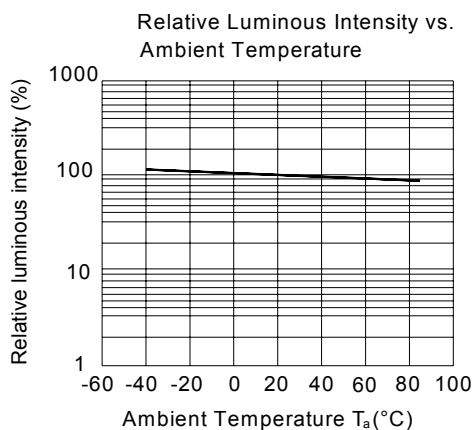
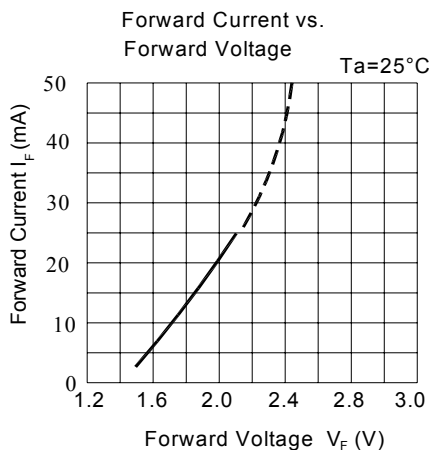
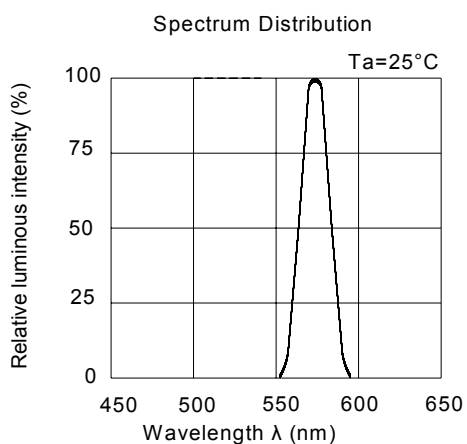



Technical Data Sheet - Preliminary

Top View LED with Bi-Color

67-22SURSYGC/S530-A3/E3/TR8

Label Explanation

CAT: Luminous Intensity Rank

HUE: Dom. Wavelength Rank

REF: Forward Voltage Rank

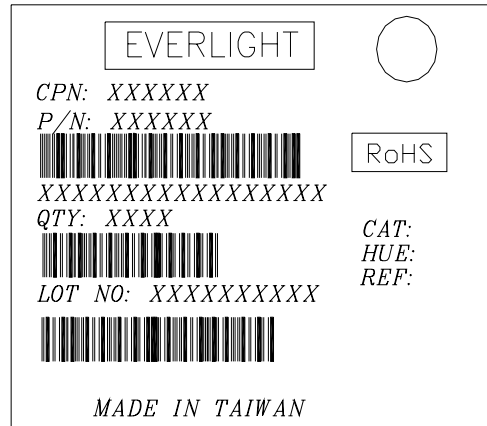

Reel Dimensions

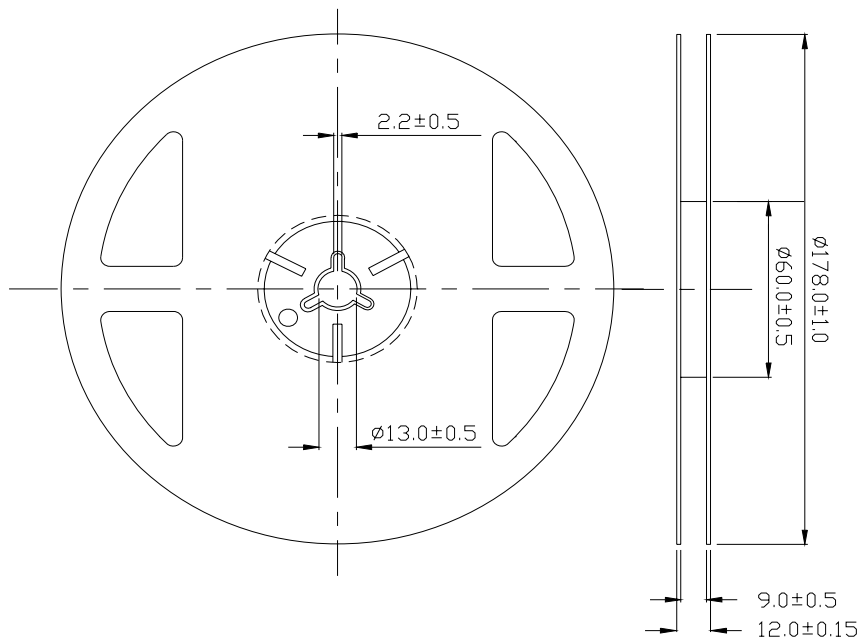

Note: Tolerance unless mentioned is ±0.1mm; Unit = mm



Technical Data Sheet - Preliminary

Top View LED with Bi-Color

67-22SURSYGC/S530-A3/E3/TR8

Carrier Tape Dimensions: Loaded Quantity 2000 pcs Per Reel

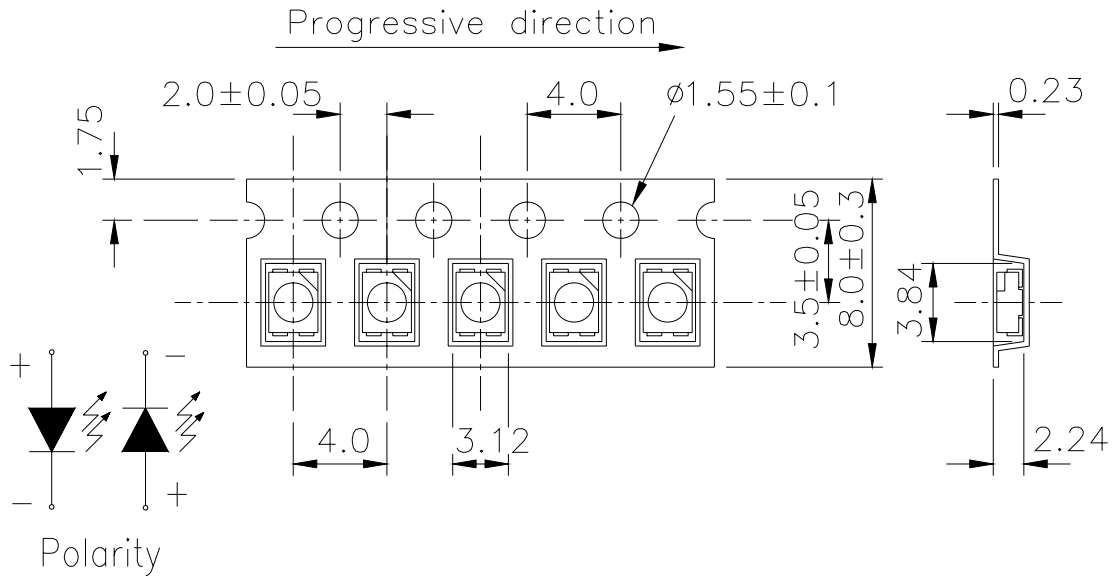

Note: Tolerance unless mentioned is ±0.1mm; Unit = mm

Moisture Resistant Packaging

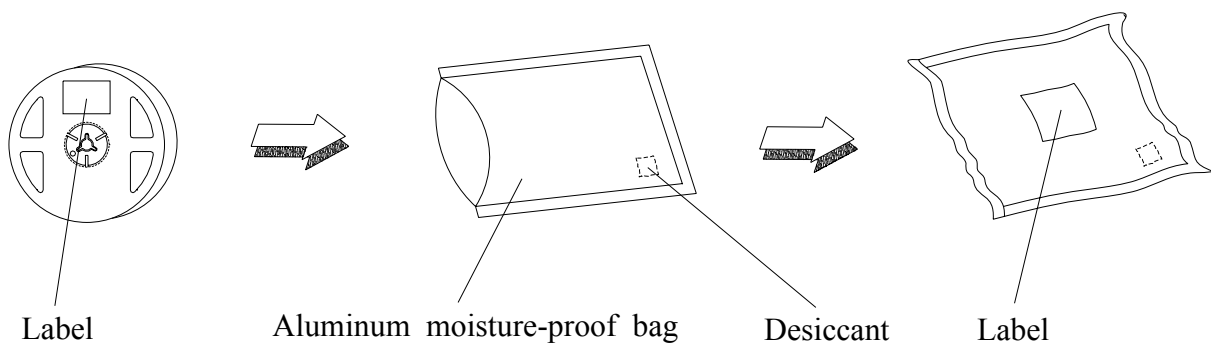

**Technical Data Sheet - Preliminary****Top View LED with Bi-Color****67-22SURSYGC/S530-A3/E3/TR8****Reliability Test Items and Conditions**

The reliability of products shall be satisfied with items listed below.

Confidence level : 90%

LTPD : 10%

No.	Items	Test Condition	Test Hours/Cycles	Sample Size	Ac/Re
1	Reflow Soldering	Temp. : 260°C±5°C Min. 5sec.	6 min	22 PCS.	0/1
2	Temperature Cycle	H : +100°C 15min ∫ 5 min L : -40°C 15min	300 Cycles	22 PCS.	0/1
3	Thermal Shock	H : +100°C 5min ∫ 10 sec L : -10°C 5min	300 Cycles	22 PCS.	0/1
4	High Temperature Storage	Temp. : 100°C	1000 Hrs.	22 PCS.	0/1
5	Low Temperature Storage	Temp. : -40°C	1000 Hrs.	22 PCS.	0/1
6	DC Operating Life	I _F = 20 mA	1000 Hrs.	22 PCS.	0/1
7	High Temperature / High Humidity	85°C / 85%RH	1000 Hrs.	22 PCS.	0/1

Technical Data Sheet - Preliminary**Top View LED with Bi-Color****67-22SURSYGC/S530-A3/E3/TR8****Precautions for Use**

1. Over-current-proof

Customer must apply resistors for protection; otherwise slight voltage shift will cause big current change (Burn out will happen).

2. Storage

2.1 Do not open moisture proof bag before the products are ready to use.

2.2 Before opening the package: The LEDs should be kept at 30°C or less and 90%RH or less.

2.3 After opening the package: The LED's floor life is 1 year under 30°C or less and 60% RH or less. If unused LEDs remain, it should be stored in moisture proof packages.

2.4 If the moisture absorbent material (silica gel) has faded away or the LEDs have exceeded the storage time, baking treatment should be performed using the following conditions.

Baking treatment: 60±5°C for 24 hours.

3. Soldering Condition

3.1 Pb-free solder temperature profile

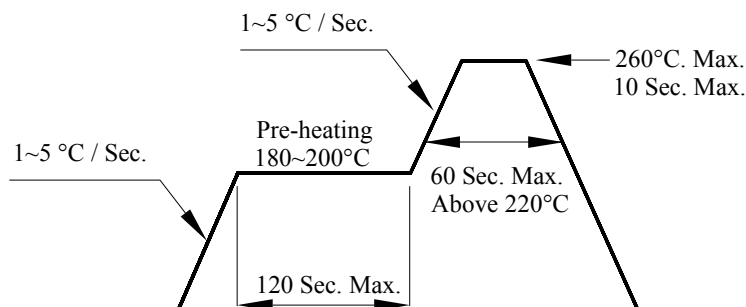

3.2 Reflow soldering should not be done more than two times.

3.3 When soldering, do not put stress on the LEDs during heating.

3.4 After soldering, do not warp the circuit board.

Technical Data Sheet - Preliminary**Top View LED with Bi-Color****67-22SURSYGC/S530-A3/E3/TR8**

4. Soldering Iron

Each terminal is to go to the tip of soldering iron temperature less than 350°C for 3 seconds within once in less than the soldering iron capacity 25W. Leave two seconds and more intervals, and do soldering of each terminal. Be careful because the damage of the product is often started at the time of the hand solder.

5. Repairing

Repair should not be done after the LEDs have been soldered. When repairing is unavoidable, a double-head soldering iron should be used (as below figure). It should be confirmed beforehand whether the characteristics of the LEDs will or will not be damaged by repairing.

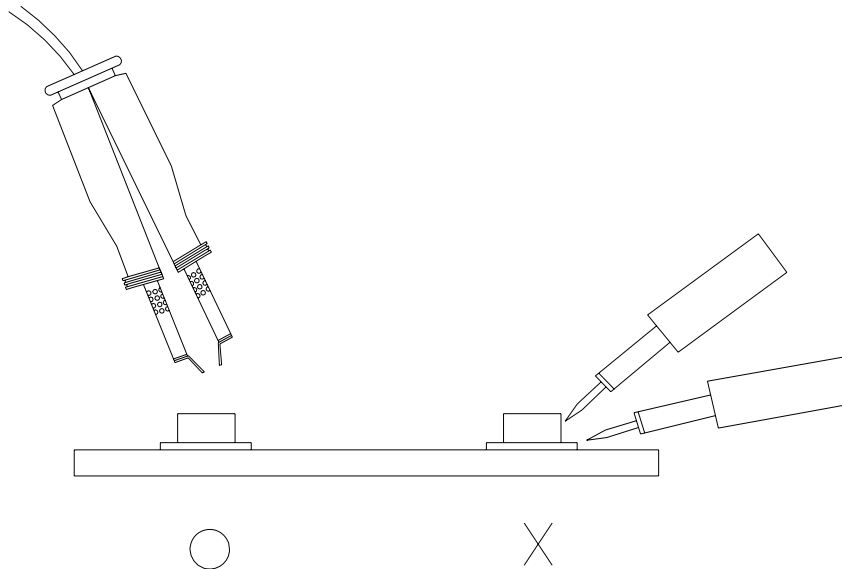

EVERLIGHT ELECTRONICS CO., LTD.
Office: No 25, Lane 76, Sec 3, Chung Yang Rd,
Tucheng, Taipei 236, Taiwan, R.O.C

Tel: 886-2-2267-2000, 2267-9936
Fax: 886-2267-6244, 2267-6189, 2267-6306
<http://www.everlight.com>