

### Introduction

KEMET entered the world of aluminum capacitors with the introduction of the AO-CAP, designated the A700 Series, which has been targeted for power management applications. The structure of the AO-CAP uses aluminum as the anode material, aluminum oxide as the dielectric, and a conductive organic polymer for its counter-electrode material. The A700 series is 100% screened for all electrical parameters: Capacitance @ 120Hz, Dissipation Factor (DF) @ 120 Hz, ESR @ 100 kHz, and DC Leakage.

The AO-CAP offers many advantages including extremely low ESR, high capacitance retention at high operating frequencies, no dry-out related failure mechanism and no voltage de-rating up to 125°C.

### ELECTRICAL

#### 1. Operating Temperature Range

- -55°C to +125°C

No derating with temperature is required.

#### 2. Non-Operating Temperature Range

- -55°C to 125°C

#### 3. Capacitance and Tolerance

- 22µF to 470µF
- ±20% Tolerance

Capacitance is measured at 120 Hz, up to 1.0 volt rms maximum and up to 2.5V DC maximum. DC bias causes only a small reduction in capacitance, up to about 2% when full rated voltage is applied. DC bias is not commonly used for room temperature measurements but is more commonly used when measuring at temperature extremes.

Capacitance does decrease with increasing frequency, but not nearly as much or as quickly as standard tantalums. Figure 1 compares the frequency induced cap roll-off between the AO-CAP and traditional MnO<sub>2</sub> types. Capacitance also increases with increasing temperature. See Section 12 for temperature coefficients.

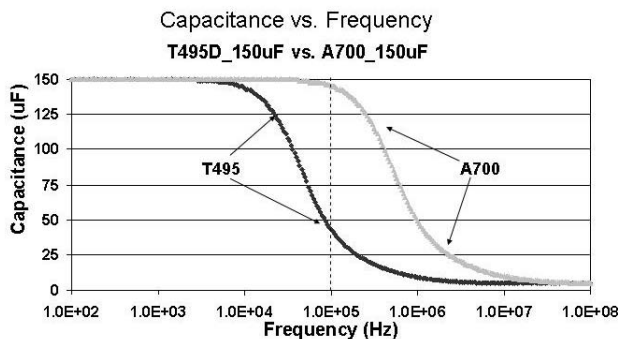

Figure 1.

#### 4. Voltage Ratings

- 2 - 10 VDC Rated Voltage

This is the maximum peak DC operating voltage from -55°C to +125°C for continuous duty.

#### Surge Voltage Ratings

Surge voltage capability is demonstrated by application of 1000 cycles of the relevant voltage at 25°C, 85°C, or 125 °C. The parts are charged through a 33 ohm resistor for 30 seconds and then discharged through a 33 ohm resistor for 30 seconds for each cycle.

Voltage Ratings • Table 1

Rated Voltage	Surge Voltage
-55°C to 125 °C	
2V	2.6V
2.5V	3.2V
4V	5.2V
6.3V	8V
8V	10.4V
10V	13V

#### 5. Reverse Voltage Rating & Polarity

Aluminum polymer capacitors are polar devices and may be permanently damaged or destroyed if connected in the wrong polarity. The positive terminal is identified by a laser-marked stripe. These capacitors will withstand a certain degree of transient voltage reversal for short periods as shown in the following table. Please note that these parts may not be operated continuously in reverse, even within these limits.

Table 2

Temperature	Permissible Transient Reverse Voltage
25°C	60% of Rated Voltage
55°C	50% of Rated Voltage
85°C	40% of Rated Voltage
125°C	30% of Rated Voltage

#### 6. DC Leakage Current

Because of the high conductivity of the polymer, the AO-CAP family has higher leakage currents than traditional MnO<sub>2</sub> type Tantalum caps. The DC Leakage limits at 25°C are calculated as 0.06 x C x V, (where C is cap in µF and V is rated voltage in Volts) for part types with rated voltage ≤ 4V, and equals 0.04 x C x V, for voltages > 4V. Limits for all part numbers are listed in the ratings tables.

DC Leakage Current is the current that flows through the capacitor dielectric after a five minute charging period at rated voltage. Leakage is measured at 25°C with full rated voltage applied to the capacitor through a 1000 ohm resistor in series with the capacitor.

DC Leakage Current does increase with temperature. The limits for 85°C @ Rated Voltage and 125°C are both 2 times the 25°C limit.

## 7. Dissipation Factor (DF)

*Refer to part number tables for maximum DF limits.*

Dissipation factor is measured at 120 Hz, up to 1.0 volt rms maximum. Dissipation factor is the ratio of the equivalent series resistance (ESR) to the capacitive reactance, ( $X_C$ ) and is usually expressed as a percentage. It is directly proportional to both capacitance and frequency. Dissipation factor loses its importance at higher frequencies, (above about 1 kHz), where impedance (Z) and equivalent series resistance (ESR) are the normal parameters of concern.

$$DF = \frac{R}{X_C} = 2\pi fCR$$

Where:

DF = Dissipation Factor

R = Equivalent Series Resistance (Ohms)

$X_C$  = Capacitive Reactance (Ohms)

f = Frequency (Hertz)

C = Capacitance (Farads)

DF is also referred to as  $\tan \delta$  or "loss tangent." The "Quality Factor," "Q", is the reciprocal of DF.

## 8. Equivalent Series Resistance (ESR) and Impedance (Z)

The Equivalent Series Resistance (ESR) of the AO-CAP is much lower than standard Tantalum caps because the polymer cathode has much higher conductivity. ESR is not a pure resistance, and it decreases with increasing frequency.

Total impedance of the capacitor is the vector sum of capacitive reactance ( $X_C$ ) and ESR below resonance; above resonance total impedance is the vector sum of inductive reactance ( $X_L$ ) and ESR.

$$X_C = \frac{1}{2\pi fC} \text{ (Ohms)}$$

Where:

f = frequency (Hertz)

C = capacitance (Farad)

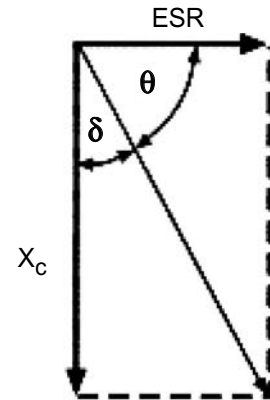

**Figure 2a Total Impedance of the Capacitor Below Resonance**

$$X_L = 2\pi fL \text{ (Ohms)}$$

Where:

f = frequency (Hertz)

L = inductance (Henries)

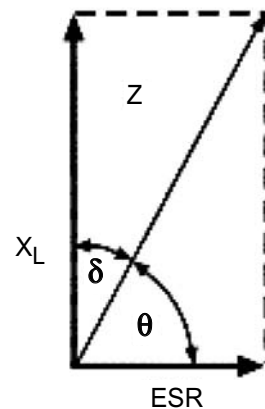

**Figure 2b Total Impedance of the Capacitor Above Resonance**

To understand the many elements of a capacitor, see Figure 3.

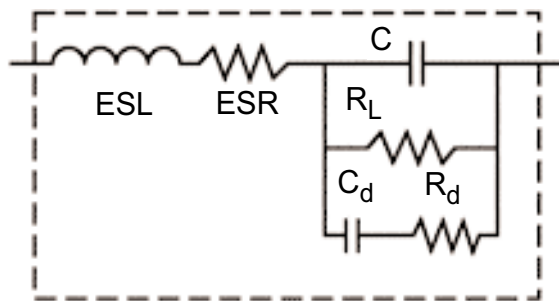

**Figure 3 The Real Capacitor**

A capacitor has a complex impedance consisting of many series and parallel elements, each adding to the complexity of the measurement system.

**ESL** - Represents inductance. In most instances it is significant at the basic measurement frequencies of 120 and 1000 Hz.

**ESR** - Represents the ohmic resistance in series with the capacitance. Lead attachment and capacitor electrodes are contributing sources.

$R_L$  - Capacitor Leakage Resistance. Typically it can be 35 K to 2.5 MOhms depending on voltage - capacitance. It can exceed  $10^{12}$  ohms in monolithic ceramics and in film capacitors.

$R_d$  - The dielectric loss contributed by dielectric absorption and molecular polarization. It becomes very significant in high frequency measurements and applications. Its value varies with frequency.

$C_d$  - The inherent dielectric absorption of the solid aluminum capacitor.

As frequency increases,  $X_C$  continues to decrease according to its equation. There is unavoidable inductance as well as resistance in all capacitors, and at some point in frequency, the reactance ceases to be capacitive and becomes inductive. This frequency is call the self-resonant point.

Figure 4 compares the frequency response of an AO-CAP to a Tantalum chip. Maximum limits for 100 kHz ESR are listed in the part number tables for each series.

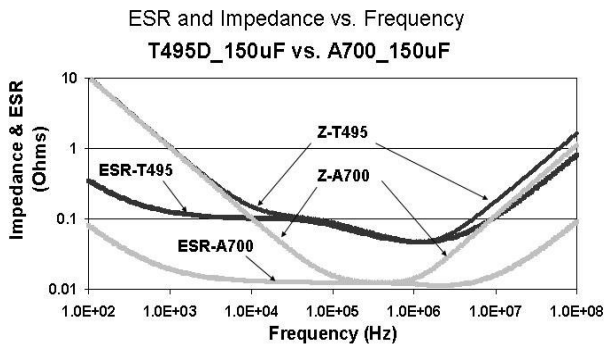

Figure 4.

**9. AC Power Dissipation**

Power dissipation is a function of capacitor size and materials. Maximum power ratings have been established for all case sizes to prevent overheating. In actual use, the capacitor's ability to dissipate the heat generated at any given power level may be affected by a variety of circuit factors. These include board density, pad size, heat sinks and air circulation.

Power capability is determined based on a 20°C temperature rise. A higher temperature rise and therefore higher power capability is allowable as long as the ambient temperature plus temperature rise due to ripple current does not exceed the rated temperature of the part.

Case Code		Maximum Power Dissipation mWatts @ +25°C with 20° Temperature Rise
KEMET	EIA	
V	7343-20	270
D	7343-31	250
X	7343-43	225

Table 3 - AO Capacitor Power Dissipation Ratings

**10. Ripple Current/Voltage**

Permissible AC ripple voltage and current are related to equivalent series resistance (ESR) and power dissipation capability.

Permissible ripple current which may be applied is limited by two criteria:

- The resulting voltage across the capacitor with the summation of DC bias and peak voltage of the AC portion must not exceed the rated voltage of the capacitor.
- The negative peak AC voltage, in combination with bias voltage, if any, must not exceed the permissible reverse voltage ratings presented in Section 5.

Actual power dissipated may be calculated from the following:

$$P = I^2R$$

$$\text{Substituting } I = \frac{E}{Z}; \quad P = \frac{E^2R}{Z^2}$$

Where:

- I = rms ripple current (Amperes)
- E = rms ripple voltage (Volts)
- P = power (Watts)
- Z = impedance at specified frequency (ohms)
- R = ESR(Ohms)

Using  $P_{max}$  from Table 3, maximum allowable rms ripple current or voltage may be determined as follows:

$$I_{max} = \sqrt{\frac{P_{max}}{ESR}} \quad E_{max} = Z \sqrt{\frac{P_{max}}{R}}$$

Where:

- $I_{max}$  = Maximum ripple current (ARMS)
- $P_{max}$  = Maximum Power @ allowable  $\Delta T$  normally +20°C
- $E_{max}$  = Maximum ripple voltage (VRMS)

Refer to part number listings for permissible Arms limits.

### ENVIRONMENTAL

#### 11. Temperature Stability

Mounted capacitors withstand extreme temperature testing at a succession or continuous steps at +25°C, -55°C, +25°C, +85°C, +125°C, +25°C in that order. Capacitors are allowed to stabilize at each temperature before measurement. Cap, DF, and DCL are measured at each temperature; except DC Leakage is not measured at -55°C.

Step	Temp	ΔCap	DCL	DF
1	25°C	Specified Tolerance	Catalog Limit	Catalog Limit
2	-55°C	15% of initial value	N/A	Catalog Limit
3	+25°C	5% of initial value	Catalog Limit	Catalog Limit
4	+85°C	15% of initial value	2X Catalog Limit	Catalog Limit
5	+125°C	20% of initial value	2X Catalog Limit	Catalog Limit
6	+25°C	5% of initial value	Catalog Limit	Catalog Limit

Table 4 - Acceptable limits are as follows:

#### 12. Standard Life Test

• **85°C, Rated Voltage, 2000 Hours**

Post Test Performance:

- Capacitance: within ±10% of initial value
- DF: within initial limit
- DC Leakage: within initial limit
- ESR: within initial limit

#### 13. High Temperature Life Test

• **125°C, Rated Voltage, 2000 Hours**

Post Test Performance:

- Capacitance: within ±10% of initial value
- DF: within initial limit
- DC Leakage: within 1.25 x initial limit
- ESR: within 2 x initial limit

#### 14. Storage Life Test

• **125°C, 0 VDC, 2000 Hours**

Post Test Performance:

- Capacitance: within ±10% of initial value
- DF: within initial limit
- DC Leakage: within 1.25 x initial limit
- ESR: within 2 x initial limit

#### 15. Thermal Shock

• **Mil-Std-202, Method 107, Condition B**

Minimum temperature is -55°C

Maximum temperature is +125°C

Post Test Performance:

- Capacitance: within ±10% of initial value
- DF: within initial limit
- DC Leakage: within initial limit
- ESR: within 2 x initial limit

#### 16. Moisture Sensitivity Level (MSL)

• **J-Std-020**

- Capacitance: within ±30% of initial value
- DF: within initial limit
- DC Leakage: within initial limit
- ESR: within 2 x initial limit

Meets MSL 3 requirements for SnPb assembly.

#### 17. Load Humidity

• **85°C, 85% RH, Rated Voltage, 500 Hours**

- Capacitance: within +30/-5% of initial value
- DF: within initial limit
- DC Leakage: within 5 x initial limit
- ESR: within 2 x initial limit

#### 18. ESD

• **Polymer Aluminum capacitors are not sensitive to Electro-Static Discharge (ESD).**

#### 19. Failure Mechanism and Reliability

The normal failure mechanism is dielectric break down. Dielectric failure can result in high DC Leakage current and may proceed to the level of a short circuit. With sufficient time to charge, healing may occur by one of two potential mechanisms. The polymer adjacent to the dielectric fault site may over-heat and vaporize, disconnecting the fault site from the circuit. The polymer may also oxidize into a more resistive material that caps the defect site in the dielectric and reduces the flow of current.

Capacitor failure may be induced by exceeding the rated conditions of forward DC voltage, reverse DC voltage, surge current, power dissipation or temperature. Excessive environmental stress, such as prolonged or high temperature reflow processes may also trigger dielectric failure.

#### 20. Resistance to Solvents

• **Mil-Std 202, Method 215**

Post Test Performance:

- Capacitance: within ±10% of initial value
- DF: within initial limit
- DC Leakage: within initial limit
- ESR: within initial limit
- Physical: no degradation of case, terminals or marking

#### 21. Fungus

• **Mil-Std-810, Method 508**

#### 22. Flammability

• **UL94 VO Classification**

### 23. Resistance to Soldering Heat

- **Maximum Reflow**  
**+245 ±5°C, 10 seconds**
- **Typical Reflow**  
**+230 ±5°C, 30 seconds**

Post Test Performance:

- Capacitance: within ±10% of initial value
- DF: within initial limit
- DC Leakage: within initial limit
- ESR: within initial limit

### 24. Solderability

- **Mil-Std-202, Method 208**
- **ANSI/J-Std-002, Test B**

### 25. Vibration

- **Mil-Std-202, Method 204, Condition D, 10 Hz to 2,000 Hz, 20G Peak**

Post Test Performance:

- Capacitance: within ±10% of initial value
- DF: within initial limit
- DC Leakage: within initial limit
- ESR: within initial limit

### 26. Shock

- **Mil-Std-202, Method 213, Condition I, 100 G Peak**

Post Test Performance:

- Capacitance: within ±10% of initial value
- DF: within initial limit
- DC Leakage: within initial limit
- ESR: within initial limit

### 27. Terminal Strength

- **Pull Force**
  - **One Pound (454 grams), 30 Seconds**

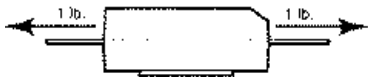

- **Tensile Force**

- **Four Pounds (1.8 kilograms), 60 Seconds**

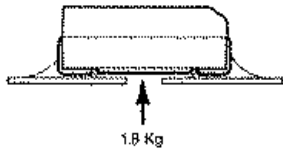

- **Shear Force**

**Table 5 Maximum Shear Loads**

Case Code		Maximum Shear Loads	
KEMET	EIA	Kilograms	Pounds
V	7343-20	5.0	11.0
D	7343-31	5.0	11.0
X	7343-43	5.0	11.0

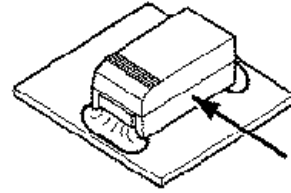

Post Test Performance:

- Capacitance: within ±5% of initial value
- DF: within initial limit
- DC Leakage: within initial limit
- ESR within initial limit

### 28. Handling

Automatic handling of encapsulated components is enhanced by the molded case which provides compatibility with all types of high speed pick and place equipment. Manual handling of these devices presents no unique problems. Care should be taken with your fingers, however, to avoid touching the solder-coated terminations as body oils, acids and salts will degrade the solderability of these terminations. Finger cots should be used whenever manually handling all solderable surfaces.

### 29. Termination Coating

The standard finish coating is 100% Sn solder (Tin-solder coated) with nickel (Ni) underplating.

### 30. Recommended Mounting Pad Geometries

Proper mounting pad geometries are essential for successful solder connections. These dimensions are highly process sensitive and should be designed to maximize the integrity of the solder joint, and to minimize component rework due to unacceptable solder joints.

Figure 5 illustrates pad geometry. The table provides recommended pad dimensions for reflow soldering techniques. These dimensions are intended to be a starting point for circuit board designers, to be fine tuned, if necessary, based upon the peculiarities of the soldering process and/or circuit board design.

Contact KEMET for Engineering Bulletin Number F-2100 entitled "Surface Mount Mounting Pad Dimensions and Considerations" for further details on this subject or visit our website at [www.kemet.com](http://www.kemet.com).

**Figure 5**

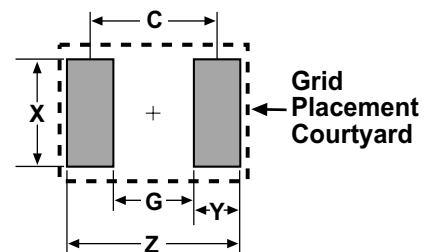

KEMET/EIA Size Code	Pad Dimensions				
	Z	G	X	Y (Ref)	C (Ref)
D/7343-31, V/7343-20 X/7343-43	8.90	3.80	2.70	2.55	6.35

**Table 6 - Land Pattern Dimensions for Reflow Solder**

### 31. Soldering

The A700 - AO-CAP family has been designed for reflow solder processes, or for wave soldering. The solder-coated terminations have excellent wetting characteristics for high integrity solder fillets. Preheating of these components is recommended to avoid extreme thermal stress. Figure 6 represents the recommended maximum solder temperature/time combinations for these devices.

Hand-soldering should be avoided. However, if necessary it should be performed with care due to the difficulty in process control. Care should be taken to avoid contact of the soldering iron to the molded case. The iron should be used to heat the solder pad, applying solder between the pad and the termination, until reflow occurs. The iron should be removed. "Wiping" the edges of a chip and heating the top surface is not recommended.

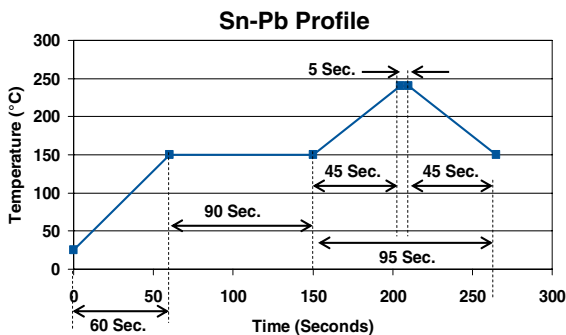

**Figure 6 Sn-Pb Profile measured on the surface of the component**

\* Contact KEMET for the latest A700 Pb-free soldering recommendations.

### 32. Washing

Standard washing techniques and solvents are compatible with all KEMET surface mount aluminum capacitors. Solvents such as Freon TMC and TMS, Trichlorethane, methylene chloride, prelate, and isopropyl alcohol are not harmful to these components. Please note that we are not endorsing the use of banned or restricted solvents. We are simply stating that they would not be harmful to the components.

If ultrasonic agitation is utilized in the cleaning process, care should be taken to minimize energy levels and exposure times to avoid damage to the terminations.

KEMET AO-CAPS are also compatible with newer aqueous and semi-aqueous processes.

### 33. Encapsulations

Under normal circumstances, potting or encapsulation of KEMET aluminum chips is not required.

### 34. Storage Environment

AO capacitors are shipped in moisture barrier bags with a desiccant and moisture indicator card. This series is classified as MSL3 (Moisture Sensitivity Level 3). Upon opening the moisture barrier bag, parts should be mounted within 7 days to prevent moisture absorption and outgassing. If the 7 day window is exceeded, the parts can be dried per the instructions on the bag (168 hours at 40 ± 5°C).

AO capacitors should be stored in normal working environments. While the chips themselves are quite robust in other environments, solderability will be degraded by exposure to high temperatures, high humidity, corrosive atmospheres, and long term storage. In addition, packaging materials will be degraded by high temperature (reels may soften or warp, and tape peel force may increase). KEMET recommends that maximum storage temperature not exceed 40 degrees C, and the maximum storage humidity not to exceed 60% relative humidity. In addition, temperature fluctuations should be minimized to avoid condensation on the parts, and atmospheres should be free of chlorine and sulfur bearing compounds. For optimized solderability, chip stock should be used promptly, preferably within 1.5 years of receipt.

### Tape & Reel Packaging

Case Codes		Tape & Reel Dimensions				
KEMET	EIA	Tape Width mm	Pitch mm ± 0.1		Reel Quantity	
			Part	Sprocket	180mm (7" dia.)	330mm (13" dia.)
V	7343-20	12 ± 0.3	8	4	1000	3000
D	7343-31	12 ± 0.3	8	4	500	2500
X	7343-43	12 ± 0.3	8	4	500	2000

### Component Marking

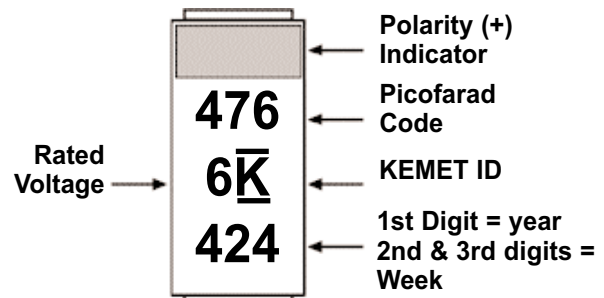

### Aluminum Component Weights

Series	Case Size	Typical Weight (mg)
A700	V/7343-20	120
A700	D/7343-31	190
A700	X/7343-43	260

**APPLICATIONS**

- Input/Output Filters for voltage regulators, converters, and SMPS
- Battery Decoupling (portable, handheld electronics)
- Power Decoupling (Processor, Transmitter circuits)
- Bulk Capacitor Requirements

**FEATURES**

- Polymer Cathode Technology
- Extremely Low ESR
- High Frequency Capacitance Retention
- Non-ignition Failure Mode
- Capacitance: 22 to 470  $\mu$ F
- Self-healing Mechanism
- -55° to +125°C Capability
- No temperature voltage Derating Up To 125°C
- Robust to Surface Mount Process
- 100% Accelerated Steady State Aging
- Pb Free and RoHS Compliant
- Solid-state Technology
- Molded Case with Wraparound Termination
- Voltage: 2 to 10V
- No Reformation Required
- EIA Standard Case Size
- No Dry-out Related Failure Mechanism

**OUTLINE DRAWING**

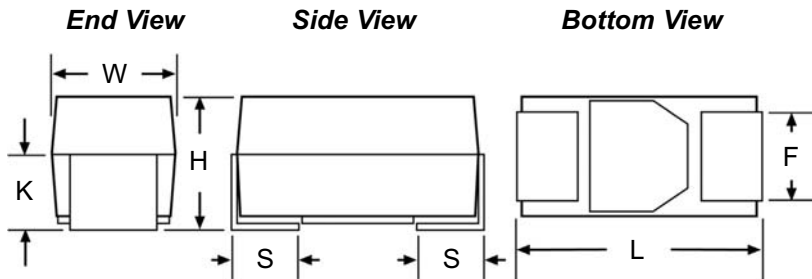

**DIMENSIONS - MILLIMETERS**

Case Size		L	W	H	K Min.	F $\pm 0.1$	S $\pm 0.2$
KEMET	EIA						
V	7343-20	7.3 $\pm$ 0.3	4.3 $\pm$ 0.3	1.9 $\pm$ 0.1	0.9	2.4	1.3
D	7343-31	7.3 $\pm$ 0.3	4.3 $\pm$ 0.3	2.8 $\pm$ 0.3	1.3	2.4	1.3
X	7343-43	7.3 $\pm$ 0.3	4.3 $\pm$ 0.3	4.0 $\pm$ 0.3	2.1	2.4	1.3

Note that glue pad shape may differ at KEMET's discretion.

**A700 ORDERING INFORMATION**

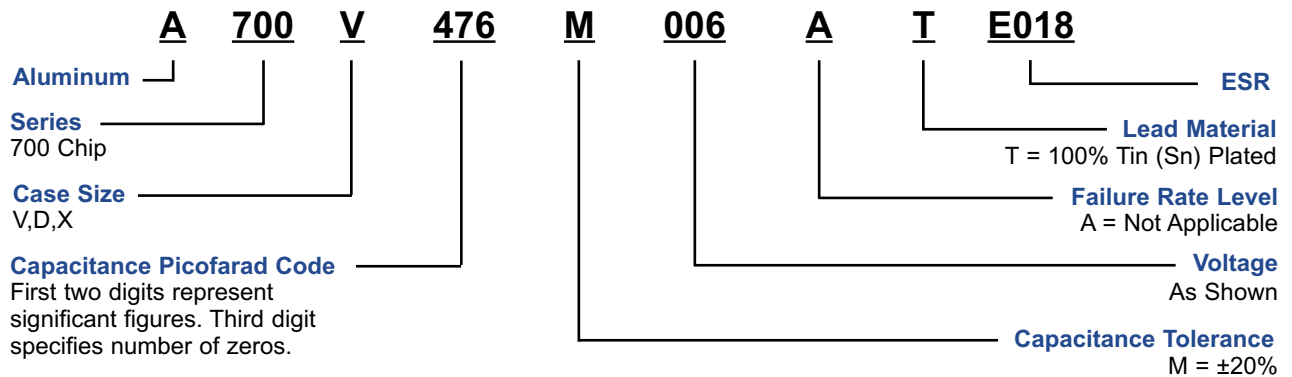

### A700 RATINGS & PART NUMBER REFERENCE

KEMET Part Number	Case Size	Cap µF	DCL @V <sub>R</sub>	DF @ 120 Hz	ESR 100 kHz (mΩ)	Ripple Current (Arms) @ 100kHz w/ΔT=+20°C @ -55°C to 125°C
<b>2 Volt Rating @ 125°C</b>						
A700V107M002ATE018	V/7343-20	100.0	12.0 µA	6%	18	3.9
A700V107M002ATE025	V/7343-20	100.0	12.0 µA	6%	25	3.3
A700V107M002ATE028	V/7343-20	100.0	12.0 µA	6%	28	3.1
A700V127M002ATE018	V/7343-20	120.0	14.4 µA	6%	18	3.9
A700V127M002ATE025	V/7343-20	120.0	14.4 µA	6%	25	3.3
A700V127M002ATE028	V/7343-20	120.0	14.4 µA	6%	28	3.1
A700V157M002ATE009	V/7343-20	150.0	18.0 µA	6%	9	5.4
A700V157M002ATE018	V/7343-20	150.0	18.0 µA	6%	18	3.9
A700V157M002ATE025	V/7343-20	150.0	18.0 µA	6%	25	3.3
A700V157M002ATE028	V/7343-20	150.0	18.0 µA	6%	28	3.1
A700D187M002ATE015	D/7343-31	180.0	21.6 µA	6%	15	4.1
A700D187M002ATE018	D/7343-31	180.0	21.6 µA	6%	18	3.7
A700V227M002ATE009	V/7343-20	220.0	26.4µA	6%	9	5.5
A700D227M002ATE015	D/7343-31	220.0	26.4 µA	6%	15	4.1
A700D227M002ATE018	D/7343-31	220.0	26.4 µA	6%	18	3.7
A700X277M002ATE010	X/7343-43	270.0	32.4 µA	6%	10	4.7
A700X277M002ATE012	X/7343-43	270.0	32.4µA	6%	12	4.3
A700X277M002ATE015	X/7343-43	270.0	32.4 µA	6%	15	3.9
A700D337M002ATE007	D/7343-31	330.0	39.6µA	6%	7	6.0
A700X337M002ATE010	X/7343-43	330.0	39.6 µA	6%	10	4.7
A700X337M002ATE015	X/7343-43	330.0	39.6 µA	6%	15	3.9
A700X397M002ATE010	X/7343-43	390.0	46.8 µA	6%	10	4.7
A700X397M002ATE015	X/7343-43	390.0	46.8 µA	6%	15	3.9
A700X477M002ATE010	X/7343-43	470.0	56.4 µA	6%	10	4.7
A700X477M002ATE015	X/7343-43	470.0	56.4 µA	6%	15	3.9
<b>2.5 Volt Rating @ 125°C</b>						
A700V826M2R5ATE018	V/7343-20	82.0	12.3 µA	6%	18	3.9
A700V826M2R5ATE025	V/7343-20	82.0	12.3 µA	6%	25	3.3
A700V826M2R5ATE028	V/7343-20	82.0	12.3 µA	6%	28	3.1
A700D157M2R5ATE015	D/7343-31	150.0	22.5 µA	6%	15	4.1
A700D157M2R5ATE018	D/7343-31	150.0	22.5 µA	6%	18	3.7
A700D187M2R5ATE015	D/7343-31	180.0	27.0 µA	6%	15	4.1
A700D187M2R5ATE018	D/7343-31	180.0	27.0 µA	6%	18	3.7
A700X227M2R5ATE010	X/7343-43	220.0	33.0 µA	6%	10	4.7
A700X227M2R5ATE015	X/7343-43	220.0	33.0 µA	6%	15	3.9
A700X337M2R5ATE010	X/7343-43	330.0	49.5 µA	6%	10	4.7
A700X337M2R5ATE015	X/7343-43	330.0	49.5 µA	6%	15	3.9
<b>4 Volt Rating @ 125°C</b>						
A700V826M004ATE018	V/7343-20	82.0	19.7 µA	6%	18	3.9
A700V826M004ATE025	V/7343-20	82.0	19.7 µA	6%	25	3.3
A700V826M004ATE028	V/7343-20	82.0	19.7 µA	6%	28	3.1
A700D127M004ATE015	D/7343-31	120.0	28.8 µA	6%	15	4.1
A700D127M004ATE018	D/7343-31	120.0	28.8 µA	6%	18	3.7
A700D157M004ATE015	D/7343-31	150.0	36.0 µA	6%	15	4.1
A700D157M004ATE018	D/7343-31	150.0	36.0 µA	6%	18	3.7
A700D187M004ATE015	D/7343-31	180.0	43.2 µA	6%	15	4.1
A700D187M004ATE018	D/7343-31	180.0	43.2 µA	6%	18	3.7
A700X187M004ATE010	X/7343-43	180.0	43.2 µA	6%	10	4.7
A700X187M004ATE015	X/7343-43	180.0	43.2µA	6%	15	3.9
A700D227M004ATE009	X/7343-43	220.0	52.8 µA	6%	9	5.3
A700X227M004ATE009	X/7343-43	220.0	52.8 µA	6%	9	5.3
A700X227M004ATE010	X/7343-43	220.0	52.8 µA	6%	10	4.7
A700X227M004ATE015	X/7343-43	220.0	52.8 µA	6%	15	3.9
A700X277M004ATE010	X/7343-43	270.0	64.8 µA	6%	10	4.7
A700X277M004ATE015	X/7343-43	270.0	64.8 µA	6%	15	3.9
A700X337M004ATE010	X/7343-43	330.0	79.2 µA	6%	10	4.7
A700X337M004ATE015	X/7343-43	330.0	79.2 µA	6%	15	3.9

Aluminum Organic Capacitors



### A700 RATINGS & PART NUMBER REFERENCE

KEMET Part Number	Case Size	Cap μF	DCL @V <sub>R</sub>	DF @ 120 Hz	ESR 100 kHz (mΩ)	Ripple Current (Arms) @ 100kHz w/ΔT=+20°C @ -55°C to 125°C
<b>6.3 Volt Rating @ 125°C</b>						
A700V226M006ATE028	V/7343-20	22.0	5.5 μA	6%	28	3.1
A700V226M006ATE045	V/7343-20	22.0	5.5 μA	6%	45	2.4
A700V336M006ATE018	V/7343-20	33.0	8.3 μA	6%	18	3.9
A700V336M006ATE025	V/7343-20	33.0	8.3 μA	6%	25	3.3
A700V336M006ATE028	V/7343-20	33.0	8.3 μA	6%	28	3.1
A700V476M006ATE018	V/7343-20	47.0	11.8 μA	6%	18	3.9
A700V476M006ATE025	V/7343-20	47.0	11.8 μA	6%	25	3.3
A700V476M006ATE028	V/7343-20	47.0	11.8 μA	6%	28	3.1
A700V566M006ATE018	V/7343-20	56.0	14.1 μA	6%	18	3.9
A700V566M006ATE025	V/7343-20	56.0	14.1 μA	6%	25	3.3
A700V566M006ATE028	V/7343-20	56.0	14.1 μA	6%	28	3.1
A700V686M006ATE018	V/7343-20	68.0	17.1 μA	6%	18	3.9
A700V686M006ATE025	V/7343-20	68.0	17.1 μA	6%	25	3.3
A700V686M006ATE028	V/7343-20	68.0	17.1 μA	6%	28	3.1
A700V826M006ATE018	V/7343-20	82.0	20.7 μA	6%	18	3.9
A700V826M006ATE025	V/7343-20	82.0	20.7 μA	6%	25	3.3
A700V826M006ATE028	V/7343-20	82.0	20.7 μA	6%	28	3.1
A700D107M006ATE015	D/7343-31	100.0	25.2 μA	6%	15	4.1
A700D107M006ATE018	D/7343-31	100.0	25.2 μA	6%	18	3.7
A700D127M006ATE012	D/7343-31	120.0	30.2 μA	6%	12	4.6
A700D127M006ATE015	D/7343-31	120.0	30.2 μA	6%	15	4.1
A700D127M006ATE018	D/7343-31	120.0	30.2 μA	6%	18	3.7
A700X157M006ATE010	X/7343-43	150.0	37.8 μA	6%	10	4.7
A700X157M006ATE012	X/7343-43	150.0	37.8 μA	6%	12	4.3
A700X157M006ATE015	X/7343-43	150.0	37.8 μA	6%	15	3.9
A700X187M006ATE010	X/7343-43	180.0	45.4 μA	6%	10	4.7
A700X187M006ATE015	X/7343-43	180.0	45.4 μA	6%	15	3.9
A700X227M006ATE015	X/7343-43	220.0	55.4 μA	6%	15	3.9
<b>8 Volt Rating @ 125°C</b>						
A700V226M008ATE028	V/7343-20	22.0	7.0 μA	6%	28	3.1
A700V226M008ATE045	V/7343-20	22.0	7.0 μA	6%	45	2.4
A700V336M008ATE018	V/7343-20	33.0	10.6 μA	6%	18	3.9
A700V336M008ATE025	V/7343-20	33.0	10.6 μA	6%	25	3.3
A700V336M008ATE028	V/7343-20	33.0	10.6 μA	6%	28	3.1
A700D566M008ATE015	D/7343-31	56.0	17.9 μA	6%	15	4.1
A700D566M008ATE018	D/7343-31	56.0	17.9 μA	6%	18	3.7
A700D686M008ATE015	D/7343-31	68.0	21.8 μA	6%	15	4.1
A700D686M008ATE018	D/7343-31	68.0	21.8 μA	6%	18	3.7
A700X107M008ATE010	X/7343-43	100.0	32.0 μA	6%	10	4.7
A700X107M008ATE012	X/7343-43	100.0	32.0 μA	6%	12	4.3
A700X107M008ATE015	X/7343-43	100.0	32.0 μA	6%	15	3.9
<b>10 Volt Rating @ 125°C</b>						
A700V226M010ATE028	V/7343-20	22.0	8.8 μA	6%	28	3.1
A700V336M010ATE018	V/7343-20	33.0	13.2 μA	6%	18	3.9
A700V336M010ATE025	V/7343-20	33.0	13.2 μA	6%	25	3.3
A700V336M010ATE028	V/7343-20	33.0	13.2 μA	6%	28	3.1
A700D566M010ATE015	D/7343-31	56.0	22.4 μA	6%	15	4.1
A700D566M010ATE018	D/7343-31	56.0	22.4 μA	6%	18	3.7
A700D686M010ATE015	D/7343-31	68.0	27.2 μA	6%	15	4.1
A700D686M010ATE018	D/7343-31	68.0	27.2 μA	6%	18	3.7
A700X107M010ATE010	X/7343-43	100.0	40.0 μA	6%	10	4.7
A700X107M010ATE015	X/7343-43	100.0	40.0 μA	6%	15	3.9
A700X127M010ATE010	X/7343-43	120.0	48.0 μA	6%	10	4.7
A700X127M010ATE015	X/7343-43	120.0	48.0 μA	6%	15	3.9
A700X157M010ATE010	X/7343-43	150.0	60.0 μA	6%	10	4.7
A700X157M010ATE015	X/7343-43	150.0	60.0 μA	6%	15	3.9
<b>12.5 Volt Rating @ 125°C</b>						
A700V106M12RATE060	V/7343-20	10.0	5.0 μA	6%	60	2.1
A700V156M12RATE040	V/7343-20	15.0	7.5 μA	6%	40	2.6
A700V226M12RATE030	V/7343-20	22.0	11.0 μA	6%	30	3.0
<b>16 Volt Rating @ 125°C</b>						
A700V685M016ATE070	V/7343-20	6.8	4.3 μA	6%	70	1.9
A700V825M016ATE070	V/7343-20	8.2	5.2 μA	6%	70	2.4

## Tape & Reel Packaging

KEMET's Molded Tantalum and Aluminum Chip Capacitor families are packaged in 8 mm and 12 mm plastic tape on 7" and 13" reels, in accordance with EIA Standard 481-1: Taping of Surface Mount Components for Automatic Handling. This packaging system is compatible with all tape fed automatic pick and place systems.

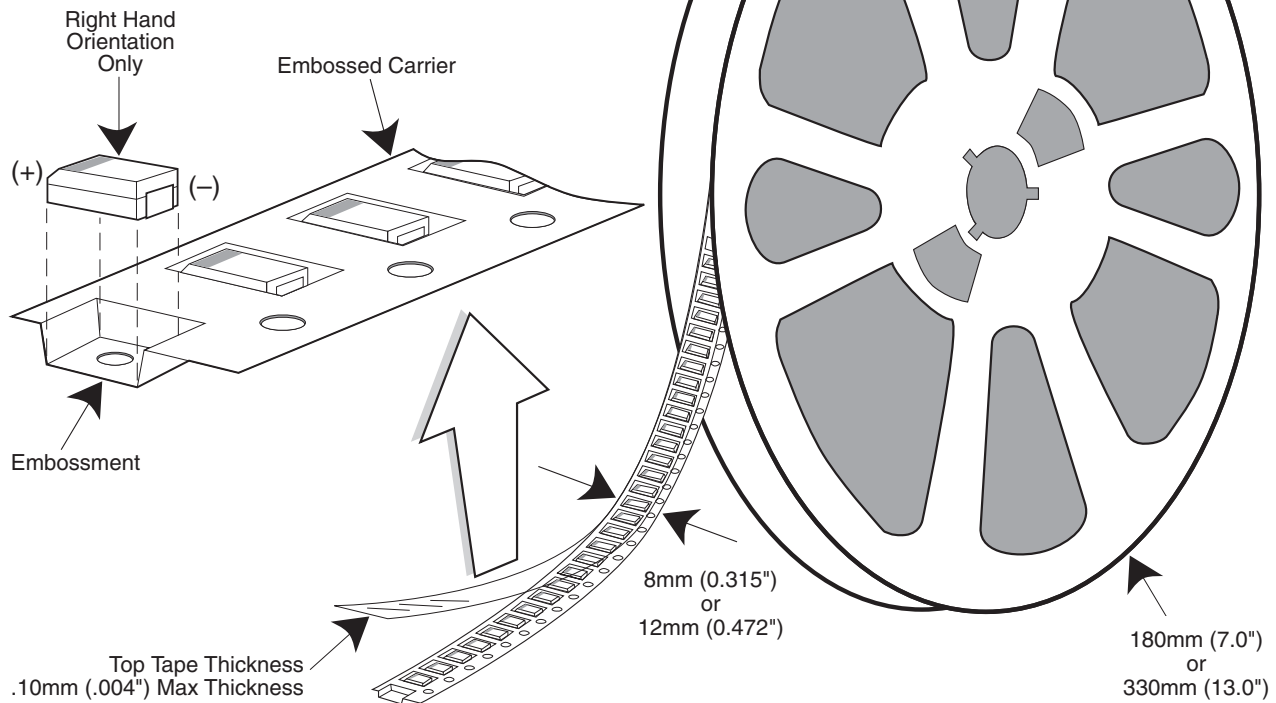

**Labeling:** Bar code labeling (standard or custom) shall be on the side of the reel opposite the sprocket holes. Refer to EIA-556.

### QUANTITIES PACKAGED PER REEL

Case Code		Tape Width-mm	7" Reel*	13" Reel*
KEMET	EIA			
R	2012-12	8	2,500	10,000
S	3216-12	8	2,500	10,000
T	3528-12	8	2,500	10,000
U	6032-15	12	1,000	5,000
W	7343-15	12	1,000	3,000
V	7343-20	12	1,000	3,000
A	3216-18	8	2,000	9,000
B	3528-21	8	2,000	8,000
C	6032-28	12	500	3,000
D	7343-31	12	500	2,500
Y	7343-40	12	500	2,000
X	7343-43	12	500	2,000
E	7260-38	12	500	2,000

\* No c-spec required for 7" reel packaging. C-7280 required for 13" reel packaging.

# TANTALUM, CERAMIC AND ALUMINUM CHIP CAPACITORS

## Packaging Information

### Performance Notes

- Cover Tape Break Force:** 1.0 Kg Minimum.
- Cover Tape Peel Strength:** The total peel strength of the cover tape from the carrier tape shall be:

Tape Width	Peel Strength
8 mm	0.1 Newton to 1.0 Newton (10g to 100g)
12 mm	0.1 Newton to 1.3 Newton (10g to 130g)

The direction of the pull shall be opposite the direction of the carrier tape travel. The pull angle of the carrier tape shall be 165° to 180° from the plane of the carrier tape. During peeling, the carrier and/or cover tape shall be pulled at a velocity of 300 ±10 mm/minute.

- Reel Sizes:** Molded tantalum capacitors are available on either 180 mm (7") reels (standard) or 330 mm (13") reels (with C-7280). Note that 13" reels are preferred.
- Labeling:** Bar code labeling (standard or custom) shall be on the side of the reel opposite the sprocket holes. Refer to EIA-556.

### Embossed Carrier Tape Configuration: Figure 1

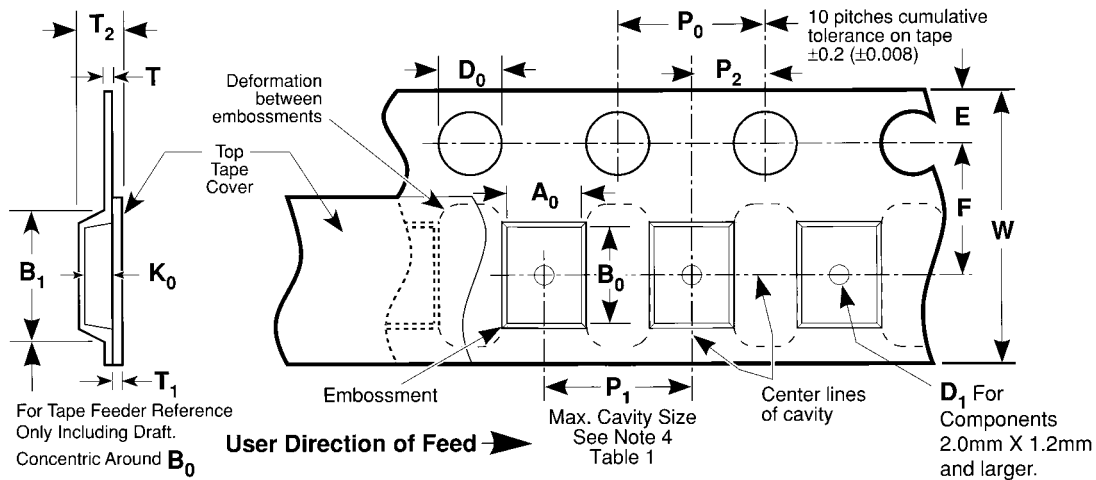

**Table 1 — EMBOSSED TAPE DIMENSIONS (Metric will govern)**

Constant Dimensions — Millimeters (Inches)									
Tape Size	D <sub>0</sub>	E	P <sub>0</sub>	P <sub>2</sub>	T Max	T <sub>1</sub> Max			
8 mm and 12 mm	1.5 +0.10 -0.0 (0.059 +0.004, -0.0)	1.75 ±0.10 (0.069 ±0.004)	4.0 ±0.10 (0.157 ±0.004)	2.0 ±0.05 (0.079 ±0.002)	0.600 (0.024)	0.100 (0.004)			
Variable Dimensions — Millimeters (Inches)									
Tape Size	Pitch	B <sub>1</sub> Max. Note 1	D <sub>1</sub> Min. Note 2	F	P <sub>1</sub>	R Min. Note 3	T <sub>2</sub> Max	W	A <sub>0</sub> B <sub>0</sub> K <sub>0</sub> Note 4
8 mm	Single (4 mm)	4.4 (0.173)	1.0 (0.039)	3.5 ±0.05 (0.138 ±0.002)	4.0 ±0.10 (0.157 ±0.004)	25.0 (0.984)	2.5 (0.098)	8.0 ±0.30 (.315 ±0.012)	
12 mm	Double (8 mm)	8.2 (0.323)	1.5 (0.059)	5.5 ±0.05 (0.217 ±0.002)	8.0 ±0.10 (0.315 ±0.004)	30.0 (1.181)	4.6 (0.181)	12.0 ±0.30 (0.472 ±0.012)	

### NOTES

- B<sub>1</sub> dimension is a reference dimension for tape feeder clearance only.
- The embossment hole location shall be measured from the sprocket hole controlling the location of the embossment. Dimensions of embossment location and hole location shall be applied independent of each other.
- Tape with components shall pass around radius "R" without damage (see sketch A). The minimum trailer length (Fig. 2) may require additional length to provide R min. for 12 mm embossed tape for reels with hub diameters approaching N min. (Table 2)
- The cavity defined by A<sub>0</sub>, B<sub>0</sub>, and K<sub>0</sub> shall be configured to surround the part with sufficient clearance such that the chip does not protrude beyond the sealing plane of the cover tape, the chip can be removed from the cavity in a vertical direction without mechanical restriction, rotation of the chip is limited to 20 degrees maximum in all 3 planes, and lateral movement of the chip is restricted to 0.5 mm maximum in the pocket (not applicable to vertical clearance.)

## Packaging Information

### Embossed Carrier Tape Configuration (cont.)

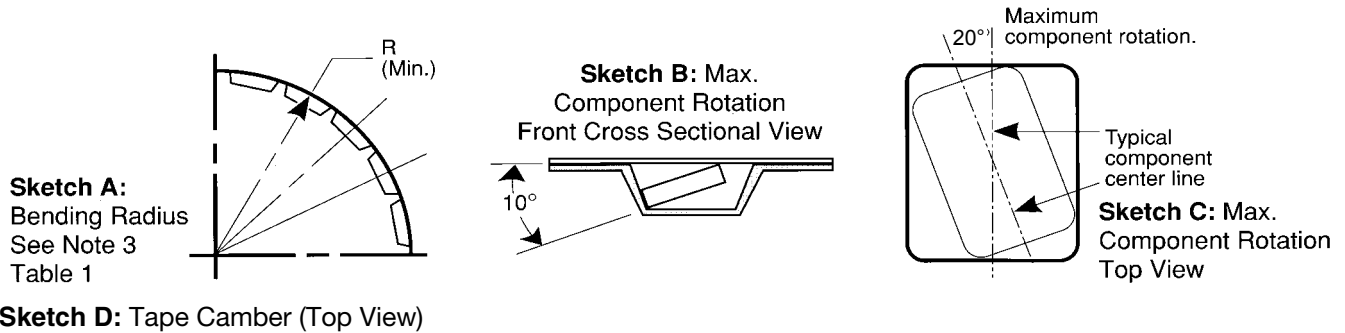

### Sketch D: Tape Camber (Top View)

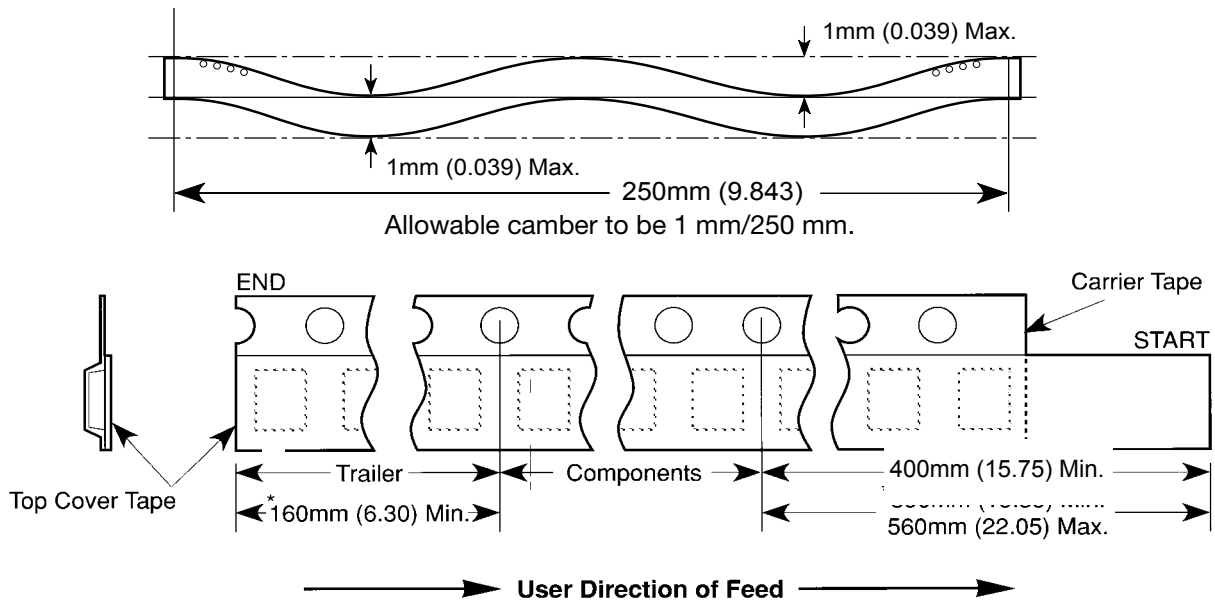

**Figure 2:**  
Tape Leader & Trailer  
Dimensions  
(Metric  
Dimensions  
Will Govern)

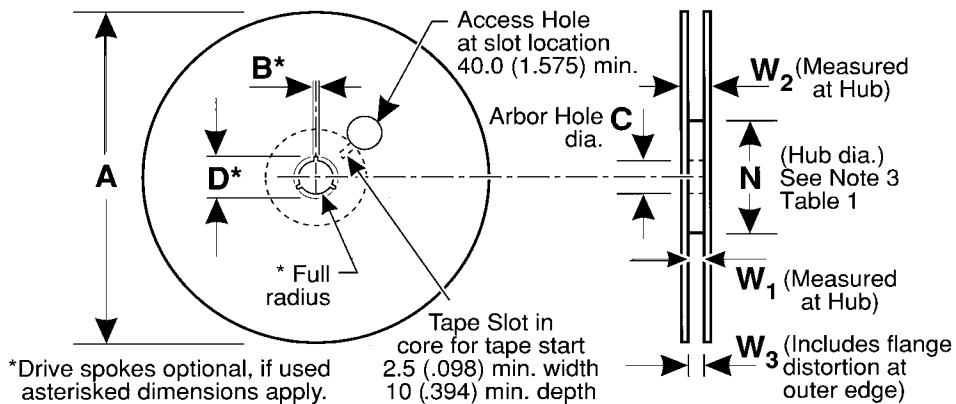

**Figure 3:** Reel Dimensions (Metric Dimensions will govern)

**Table 2 – REEL DIMENSIONS (Metric will govern)**

Tape Size	A Max	$B^*$ Min	C	$D^*$ Min	N Min	$W_1$	$W_2$ Max	$W_3$
8 mm	330.0 (12.992)	1.5 (0.059)	13.0 ± 0.20 (0.512 ± 0.008)	20.2 (0.795)	50.0 (1.969) See Note 3	8.4 +1.5, -0.0 (0.331 +0.059, -0.0)	14.4 (0.567)	7.9 Min (0.311) 10.9 Max (0.429)
12 mm	330.0 (12.992)	1.5 (0.059)	13.0 ± 0.20 (0.512 ± 0.008)	20.2 (0.795)	Table 1	12.4 +2.0, -0.0 (0.488 +0.078, -0.0)	18.4 (0.724)	11.9 Min (0.469) 15.4 Max (0.606)