

Common Mode Filters(SMD)

For CAN-BUS/General signal line

ZJYS series

Type: **ZJYS81 (2 lines)**
 ZJYS51 (2 and 4 lines)

Issue date: December 2010

- All specifications are subject to change without notice.
- Conformity to RoHS Directive: This means that, in conformity with EU Directive 2002/95/EC, lead, cadmium, mercury, hexavalent chromium, and specific bromine-based flame retardants, PBB and PBDE, have not been used, except for exempted applications.

Common Mode Filters(SMD) For CAN-BUS / General Signal Line

Conformity to RoHS Directive

ZJYS Series ZJYS81 Type

FEATURES

- Operating temperature range covers from -40 to $+125^{\circ}\text{C}$.
- Non-dissolution of the abutment amounts in circuit board mounting.
- The products contain no lead and also support lead-free soldering.
- This product conforms to the standards that are slated to be introduced under the RoHS Directive.

APPLICATIONS

CAN-BUS system, facsimiles, modems, ISDN

PACKAGING STYLE AND QUANTITIES

Packaging style	Quantity
Taping	1500 pieces/reel

PRODUCT IDENTIFICATION

ZJYS81R5 - 2P L 25 (T) - G01
 (1) (2) (3) (4) (5) (6)

- Series name
- Number of line
2P: 2-line
- Winding type
L: Sector
No mark: Bifilar
- Product identification number
- Packaging style
T: $\varnothing 330\text{mm}$ reel taping
- TDK internal code

SHAPES AND DIMENSIONS

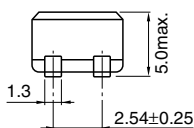
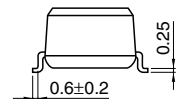
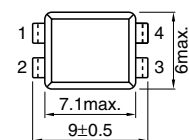

CIRCUIT DIAGRAM

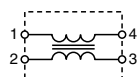

• No polarity

RECOMMENDED PC BOARD PATTERN

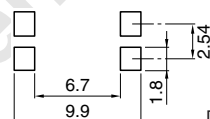

Dimensions in mm

Weight: 0.4g

Dimensions in mm



ELECTRICAL CHARACTERISTICS

Part No.	Common mode impedance (Ω)[10MHz]		DC resistance (Ω)max.	Rated current (A)max.	Insulation resistance (M Ω)min.	Rated voltage (V)max.
	min.	typ.				
ZJYS81R5-2P24-G01	500	1000	0.15	0.5	100	80
ZJYS81R5-2P50-G01	1000	2000	0.25	0.5	100	80
ZJYS81R5-2PL25-G01	600	1000	0.25	0.5	100	80
ZJYS81R5-2PL51-G01	1000	2000	0.3	0.5	100	80

TYPICAL ELECTRICAL CHARACTERISTICS

IMPEDANCE vs. FREQUENCY CHARACTERISTICS

ZJYS81R5-2P24

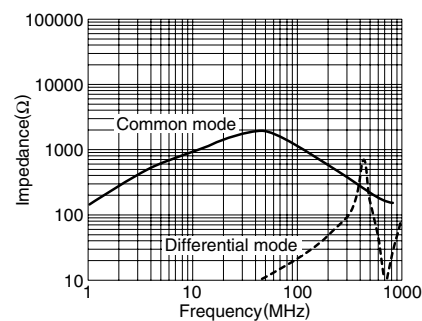

ZJYS81R5-2P50

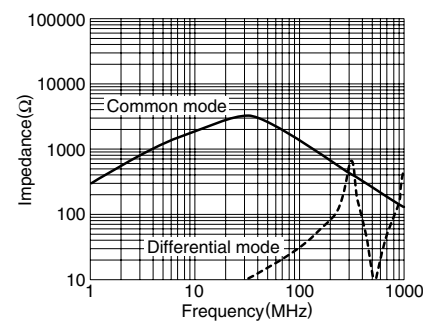

ZJYS81R5-2PL25

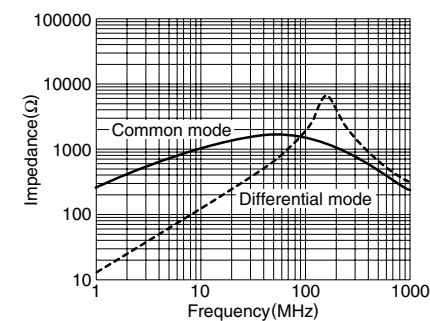

- Conformity to RoHS Directive: This means that, in conformity with EU Directive 2002/95/EC, lead, cadmium, mercury, hexavalent chromium, and specific bromine-based flame retardants, PBB and PBDE, have not been used, except for exempted applications.

• All specifications are subject to change without notice.

TYPICAL ELECTRICAL CHARACTERISTICS IMPEDANCE vs. FREQUENCY CHARACTERISTICS

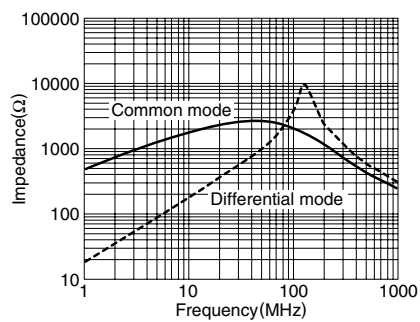

onlinecomponents.com

Common Mode Filters(SMD) For General Signal Line

onlinecomponents.com
THE ONLINE DISTRIBUTOR OF ELECTRONIC COMPONENTS

Conformity to RoHS Directive

ZJYS Series ZJYS51 Type

FEATURES

- A common mode filter for distortion-free noise removal from transmitted signals. Optimized for transmission of high quality signals.
- Best filter for countering the common mode noise resulting from data signal processing by PCs, phone equipment, etc.
- SMD-type designed for surface mounting.
- Due to a maximum current tolerance of 2A, can also be used to counter power line noise.

APPLICATIONS

Personal computers, telephones, LANs, ISDNs, digital PBXs, electronic games, CTVs, CD-ROM drives, 8mm video equipment, and other electronic devices.

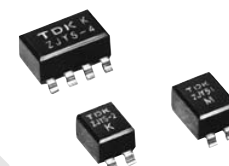

SHAPES AND DIMENSIONS/RECOMMENDED PC BOARD PATTERNS

TRANSFER MOLD

ZJYS51R5-2P(T)-01, -2PB(T)-01, -2PL(T)-01

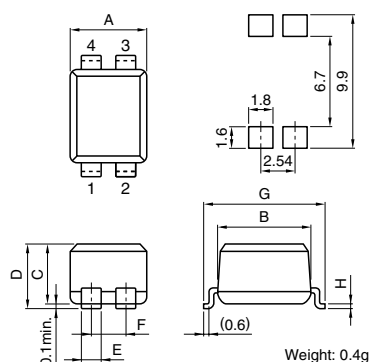

ZJYS51R5-4P(T)-01, -M4PA(T)-01

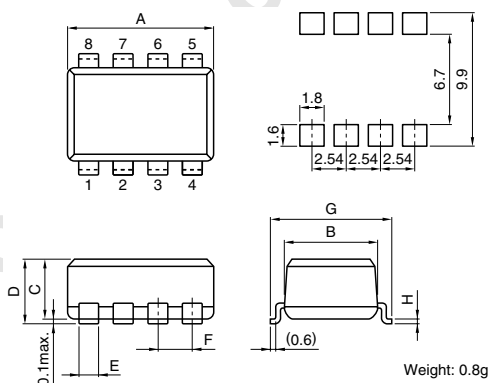

Dimensions in mm

Part No.	A max.	B max.	C max.	D max.	E	F	G max.	H
ZJYS51R5-2P(T)-01, -2PB(T)-01, -2PL(T) ^{*1} -01 ^{*2}	5.5	6.86	4.57	5.08	1.3	2.54±0.25	9±0.5	0.25
ZJYS51R5-4P(T)-01, -M4PA(T)-01	10.5	6.86	4.57	5.08	1.3	2.54±0.25	9±0.5	0.25

^{*1} T means the taping product.

^{*2} The "-01" designation at the end of the product code indicates conformity to RoHS directive.

CIRCUIT DIAGRAMS

ZJYS51R5-2P(T)-01,-2PB(T)-01, -2PL(T)-01

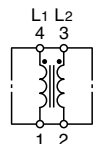

ZJYS51R5-4P(T)-01, -M4PA(T)-01

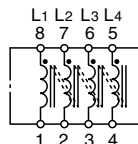

- Conformity to RoHS Directive: This means that, in conformity with EU Directive 2002/95/EC, lead, cadmium, mercury, hexavalent chromium, and specific bromine-based flame retardants, PBB and PBDE, have not been used, except for exempted applications.

- All specifications are subject to change without notice.

ELECTRICAL CHARACTERISTICS

Part No.	ZJYS51R5-2P(T)-01, 4P(T)-01	ZJYS51R5-2PB(T)-01*1	ZJYS51R5-2PL(T)-01*2	ZJYS51R5-M4PA(T)-01
Rated voltage Edc(V)	50	50	50	50
Rated current (A)	2	2	2	0.5
Test voltage Edc(V) [Between terminals for 5s]	125	125	250	125
Insulation resistance (MΩ) [Between terminals at DC.50V for 1min]	100 min.	100 min.	100 min.	100 min.
DC resistance (Ω) [Each line]	0.12 max.	0.12 max.	0.10 max.	0.25 max.
Operating temperature range (°C)	-25 to +85	-25 to +85	-25 to +85	-25 to +85
Impedance (Ω) [+5 to +35°C]	200 min.[20 to 300MHz]	300 min.[6 to 20MHz]	100 min.[20 to 100MHz]	200 min.[20 to 300MHz]

*1 The characteristics of low area reform type.

*2 Separate winding type (for communications).

• The "T" designation at the end of the product code indicates tape mounting.

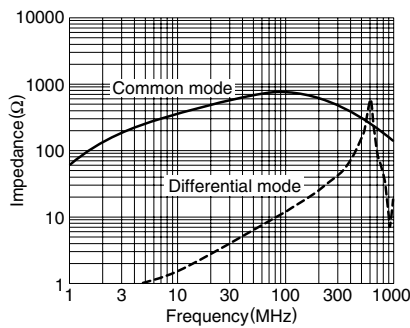
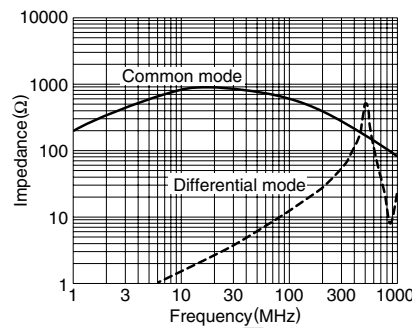
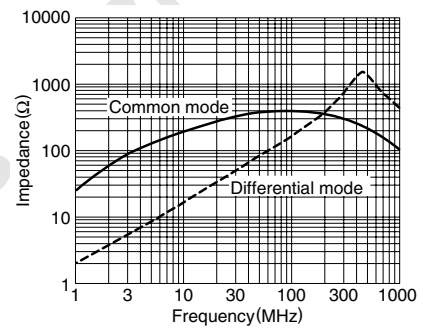
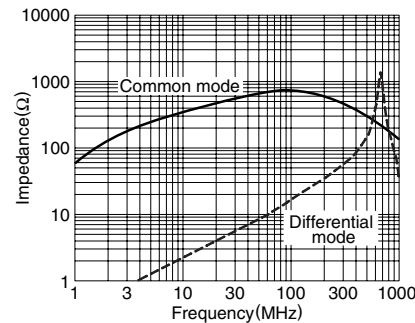
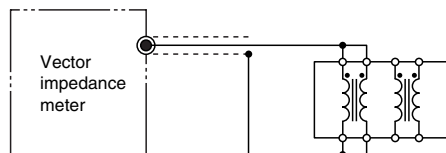
TYPICAL ELECTRICAL CHARACTERISTICS
IMPEDANCE CHARACTERISTICS (for 1 element)
ZJYS51R5-2P-01, 4P(T)-01

ZJYS51R5-2PB-01

ZJYS51R5-2PL-01

ZJYS51R5-M4PA-01

MEASURING CIRCUIT

Vector impedance meter (YHP 4191A equivalent)
Measuring at each Common mode choke coil

PACKAGING STYLE AND QUANTITIES

Part No.	Taping (/reel)	Bulk
ZJYS51R5-2P(T)-01	1500 pieces	200 pieces
ZJYS51R5-2PB(T)-01	1500 pieces	200 pieces
ZJYS51R5-2PL(T)-01	1500 pieces	200 pieces
ZJYS51R5-4P(T)-01	1000 pieces	100 pieces
ZJYS51R5-M4PA(T)-01	1000 pieces	100 pieces

• All specifications are subject to change without notice.

TYPICAL APPLICATION

An application example showing how radiation noise is prevented when transmitter and receiver are connected via twisted pair cabling.

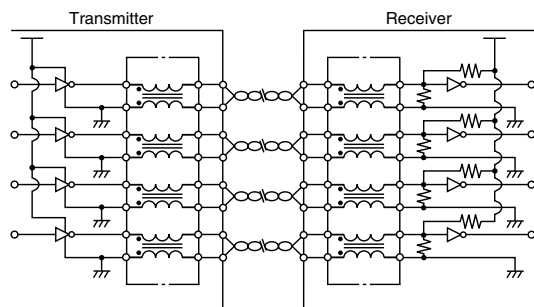

TYPICAL APPLICATION EFFECTS

(a) Without EMC filter

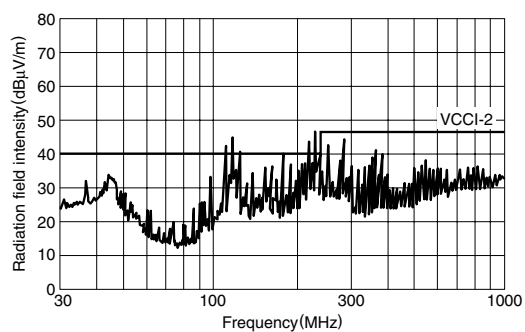

(b) With EMC filter
ZJYS51R5-2P(T)-01

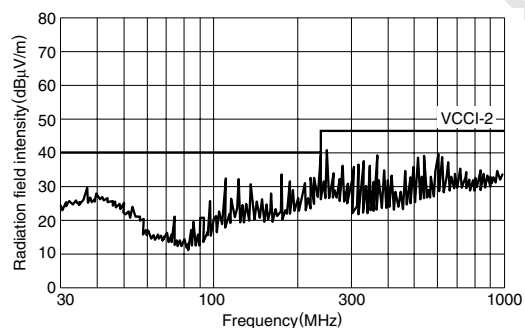

• All specifications are subject to change without notice.