

DESCRIPTION

The ACA0861 family of surface mount monolithic GaAs RF Linear Amplifiers has been developed to replace, in new designs, the standard CATV Hybrid amplifiers currently in use. The MMICs consist of two parallel amplifiers, each with 12 dB gain. The Amplifiers are optimized for exceptionally low distortion and noise figure while providing flat gain and excellent input and output return loss. There are four differently specified Amplifiers available, two input stages and two output stages. The ACA0861A and the ACA0861C are input stages and are specified at +34 dBmV flat output. The ACA0861B and ACA0861D are output stages and are specified at +44 dBmV flat output. A Hybrid equivalent is formed when one input stage ACA0861 is cascaded with an ACA0861 output stage between two transmission line baluns. For low gain applications a single ACA0861 can be used between baluns, for higher gain applications more than two ACA0861 can be cascaded between baluns. See ACA0861 application note for more information.

FEATURES

- **Flat Gain**
- **Very Low Distortion**
- **Excellent Input/Output Match**
- **Low DC Power Consumption**
- **Good RF Stability with high VSWR Load Conditions**
- **Surface Mount Package**
- **Package Fully Automatic Assembly Compatible**
- **Low Cost**
- **Repeatability of Monolithic Fabrication**
- **Meets Cenelec Standard**

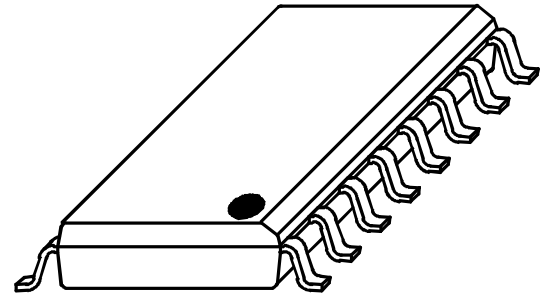

ABSOLUTE MAXIMUM RATINGS

PARAMETER	MIN.	MAX.	UNITS
V_{DD}/V_{RFOUT}	0	15	V_{DC}
RF_{IN}		+70	dBmV
Storage Temperature	-65	+150	°C
Soldering Temperature		+260	°C
Soldering Time		5.0	Sec.
Thermal Resistance		6.0	°C/W
Operating Temperature	-40	110	°C

INPUT STAGES

The ACA0861A and the ACA0861C are designed as input stages and are specified at +34 dBmV flat output. These parts can be used alone for low gain, low output level applications or can be cascaded with one of the ACA0861 output stages for higher gain and output signal drive level. The ACA0861A is a low power dissipation part designed to drive the ACA0861B output stage. The ACA0861C is a slightly higher power dissipation part and provides the needed distortion parameters to drive the ACA0861D output stage.

OUTPUT STAGES

The ACA0861B and ACA0861D are designed as output stages and are specified at + 44 dBmV flat output. These parts can be used alone for low gain, high output level applications or can be cascaded with one of the ACA0861 input stages for higher gain. The ACA0861B is a low power dissipation part designed as the output stage with an ACA0861A input stage. The ACA0861D is a higher power dissipation part designed as the output stage with an ACA0861C input stage. An ACA0861A and ACA0861B cascaded provide exceptional push-pull hybrid equivalent performance, an ACA0861C and ACA0861D cascaded provide exceptional power doubling hybrid equivalent performance (see Figure 2).

ELECTRICAL SPECIFICATIONS ($T_A = +25^\circ\text{C}$, $V_{DD} = 12\text{V}$, TEST CIRCUIT SHOWN IN FIG. 1)

PARAMETER	ACA0861A			ACA0861B			ACA0861C			ACA0861D			Units
	Min	Typ	Max	Min	Typ	Max	Min	Typ	Max	Min	Typ	Max	
Bandwidth ¹	40		860	40		860	40		860	40		860	MHz
Gain ¹	11.4	11.9	12.4	11.5	12	12.5	11.5	12	12.5	11.6	12.1	12.6	dB
Gain Flatness ¹			±0.3			±0.3			±0.3			±0.3	dB
Noise Figure ²		3	5		3	5		3	5		3	6	dB
CTB ^{2,3}													
77 Channels		-70			-62			-77			-70		dBc
110 Channels		-68	-64		-60	-57		-75	-68		-68	-64	dBc
128 Channels		-65			-58			-71			-67		dBc
CSO ^{2,3}													
77 Channels		-71			-66			-75			-72		dBc
110 Channels		-71	-66		-66	-60		-75	-68		-72	-68	dBc
128 Channels		-70			-64			-73			-70		dBc
XMOD ^{2,3}													
77 Channels		-67			-62			-74			-71		dBc
110 Channels		-63	-56		-56	-50		-71	-62		-68	-61	dBc
128 Channels		-59			-55			-67			-66		dBc
Supply Current ⁴		180	200		310	330		260	275		475	515	mA
Cable Equivalent Slope ¹	-0.5		1.0	-0.5		1.0	-0.5		1.0	-0.5		1.0	dB
Return Loss (Input/Output) ¹	18	22		18	22		18	22		18	22		dB

Notes:

1. Measured performance of MMIC alone. Balun effects deimbedded from measurement.
2. Measured with a balun on input and output of the device. See Figure 1 for test setup.
3. All parts measured with 110 channel flat input. Parts A & C measured at +34 dBmV output. Parts B & D measured at 44 dBmV output (per channel).
4. A fixed resistor is needed for parts A through C, part D does not need an external resistor. These resistors set the devices' current draw. Bias voltage is 12 VDC.

ACA0861A AND ACA0861B CASCADE TYPICAL DATA

(SEE FIGURE 2)

GAIN / S21

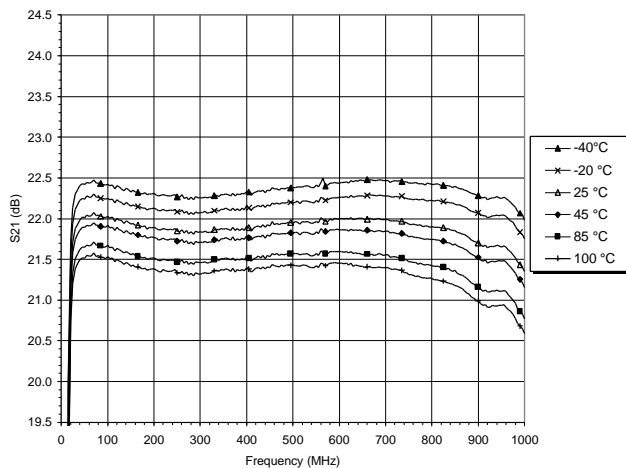

INPUT RETURN LOSS / S11

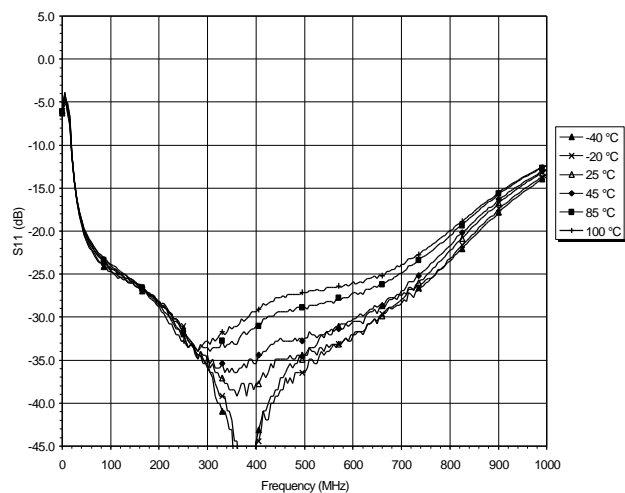

OUTPUT RETURN LOSS / S22

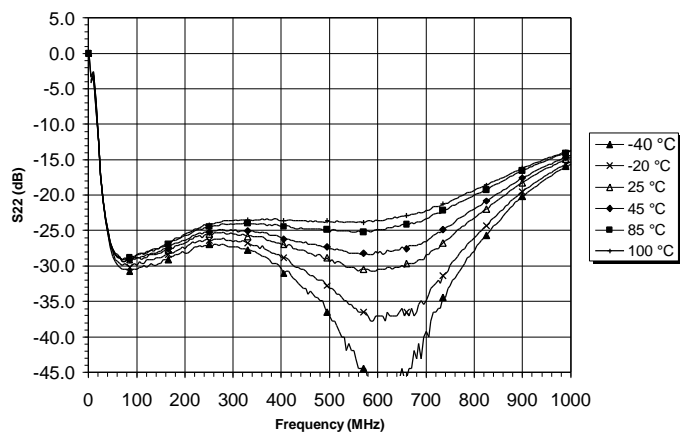

REVERSE ISOLATION / S12

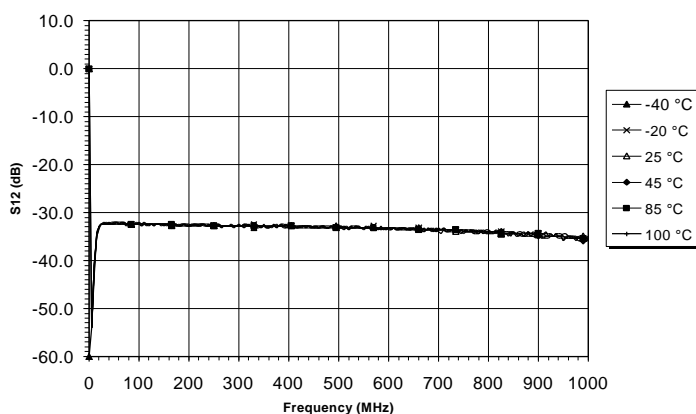

NOISE FIGURE VS FREQUENCY

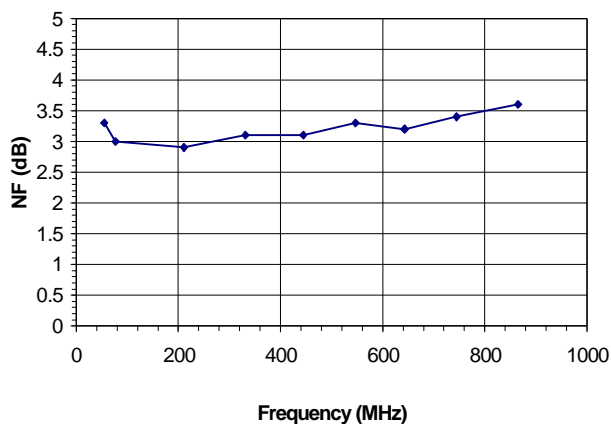

ACA0861A AND ACA0861B CASCADE TYPICAL DATA (SEE FIGURE 2)

CTB VS. FREQUENCY
77 CHANNEL LOADING, FLAT

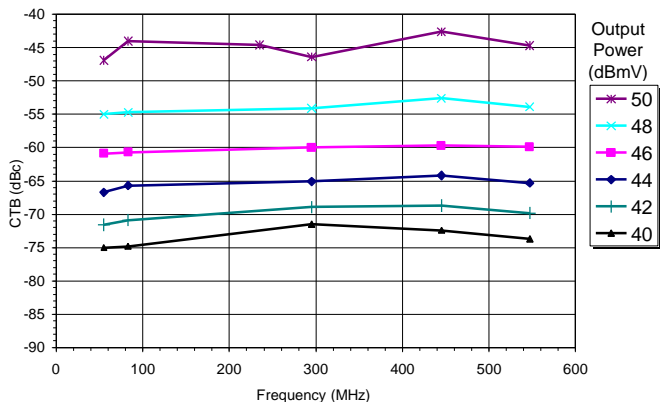

CSO VS. FREQUENCY
77 CHANNEL LOADING, FLAT

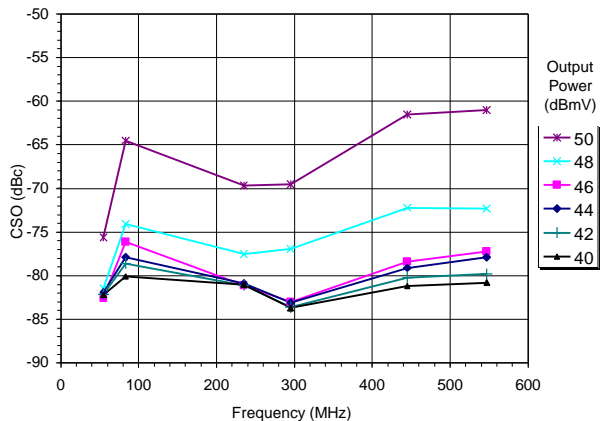

XMOD VS. FREQUENCY
77 CHANNEL LOADING, FLAT

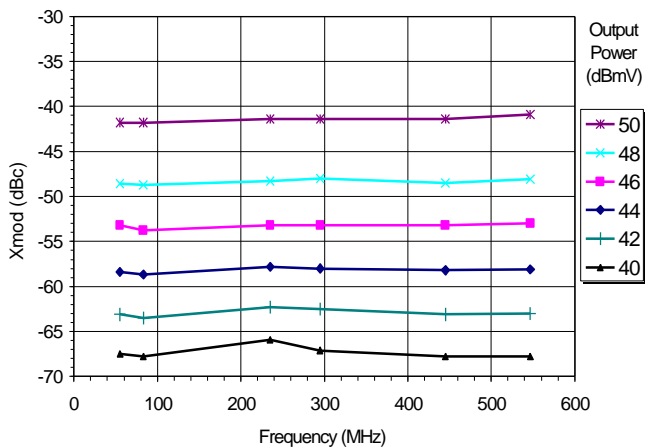

CTB VS. FREQUENCY
110 CHANNEL LOADING, FLAT

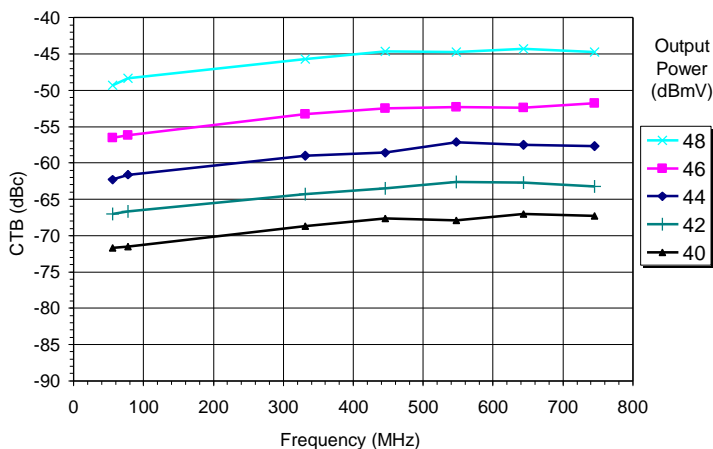

CSO VS. FREQUENCY
110 CHANNEL LOADING, FLAT

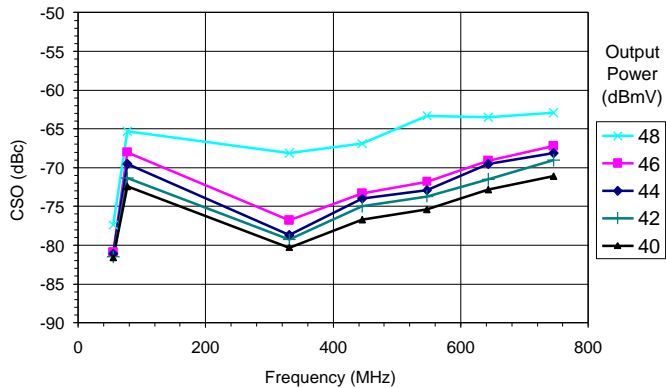

XMOD VS. FREQUENCY
110 CHANNEL LOADING, FLAT

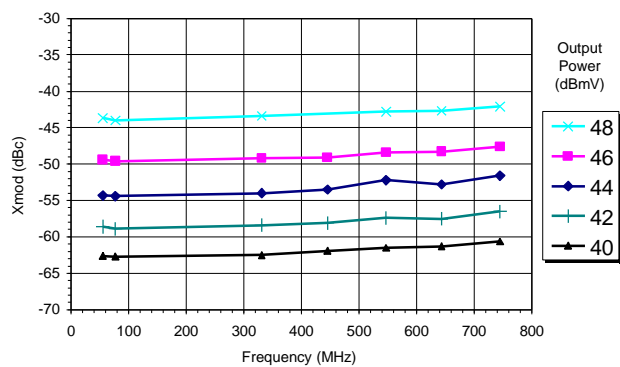

ACA0861A AND ACA0861B CASCADE TYPICAL DATA

(SEE FIGURE 2)

CTB VS. FREQUENCY
128 CHANNEL LOADING, FLAT

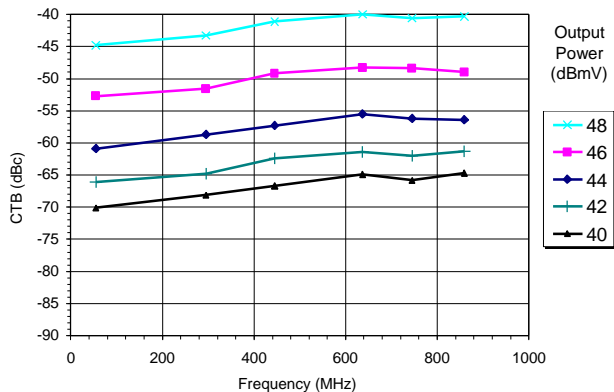

CSO VS. FREQUENCY
128 CHANNEL LOADING, FLAT

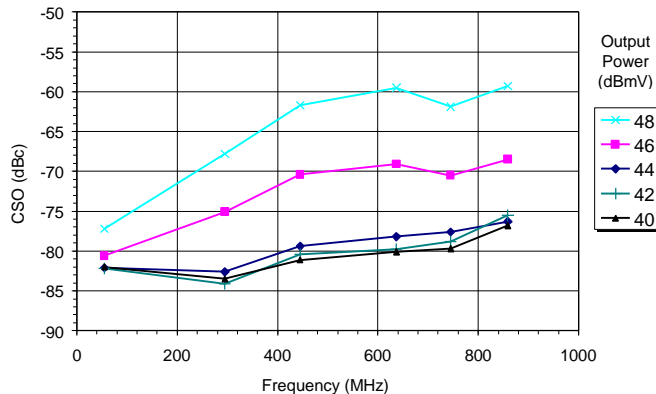

XMOD VS. FREQUENCY
128 CHANNEL LOADING, FLAT

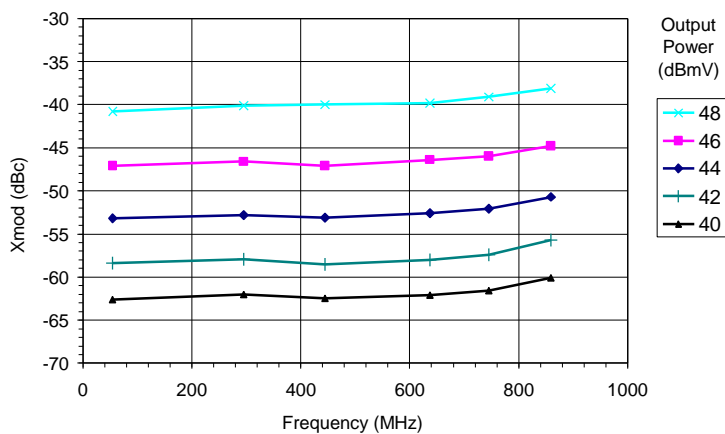

ACA0861C AND ACA0861D CASCADE TYPICAL DATA

(SEE FIGURE)

GAIN / S21

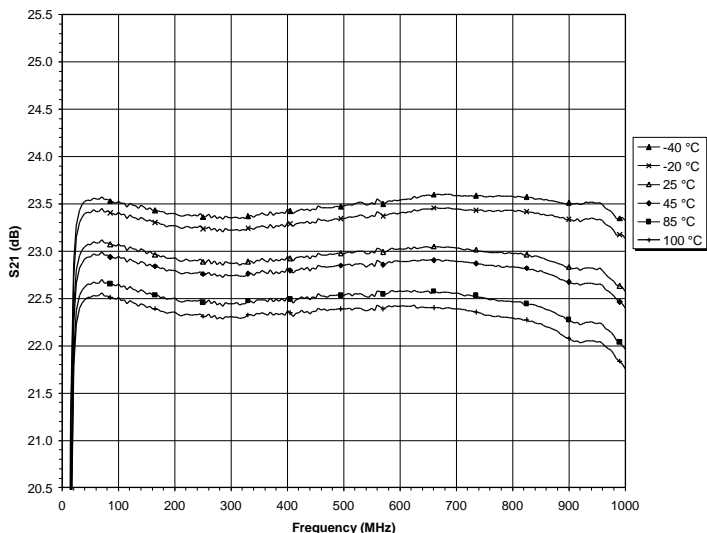

INPUT RETURN LOSS / S11

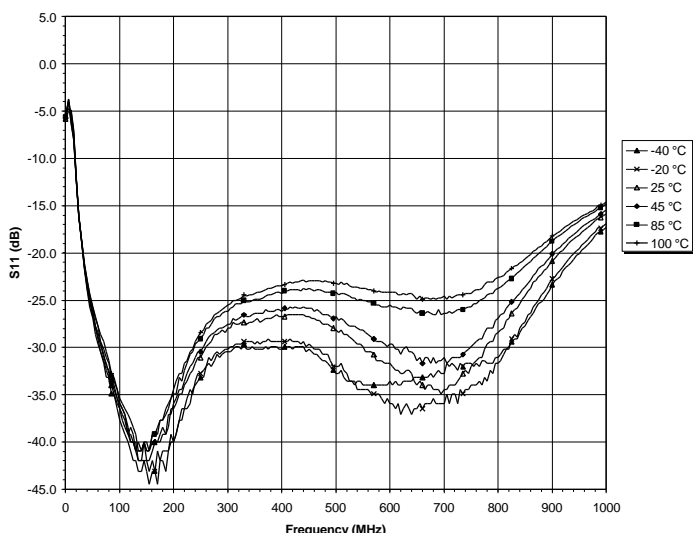

OUTPUT RETURN LOSS / S22

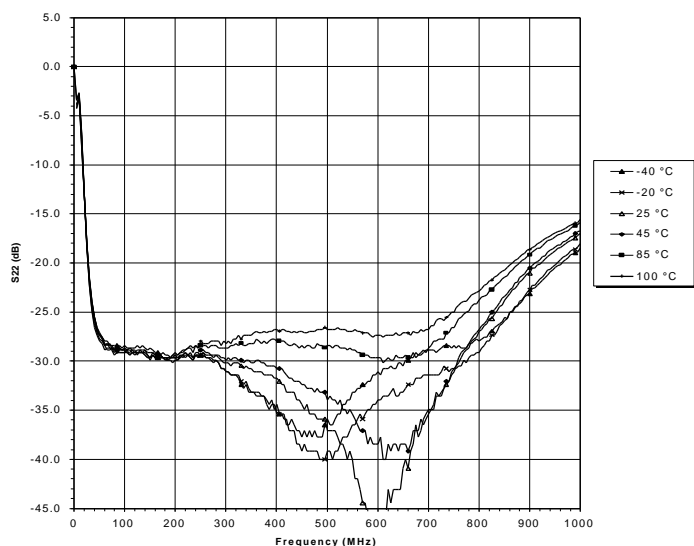

REVERSE ISOLATION / S12

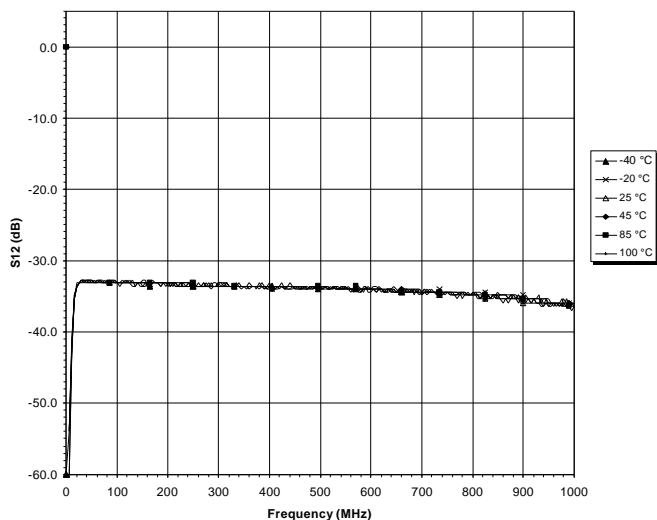

NOISE FIGURE VS FREQUENCY

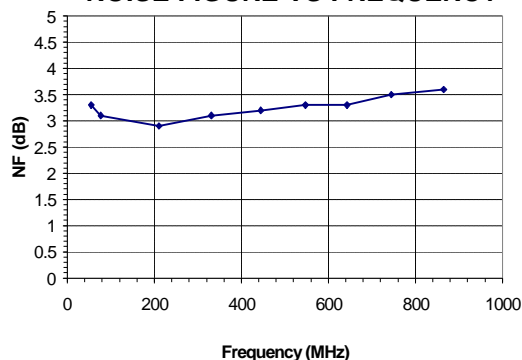

ACA0861C AND ACA0861D CASCADE TYPICAL DATA

(SEE FIGURE)

CTB VS. FREQUENCY
77 CHANNEL LOADING, FLAT

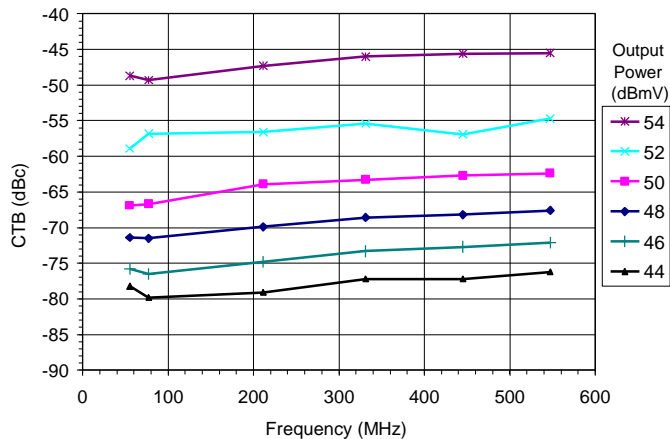

CSO VS. FREQUENCY
77 CHANNEL LOADING, FLAT

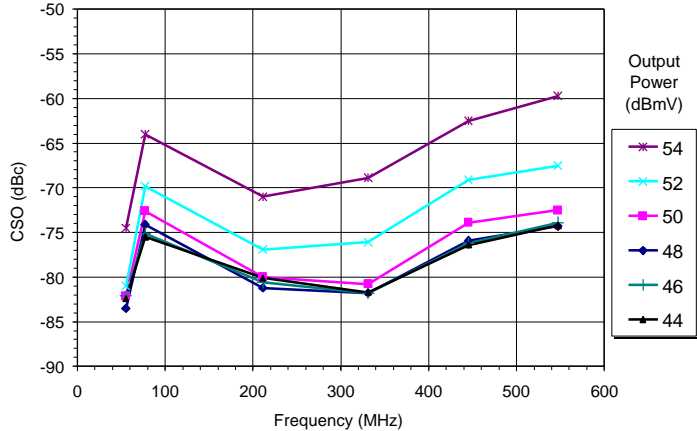

XMOD VS. FREQUENCY
77 CHANNEL LOADING, FLAT

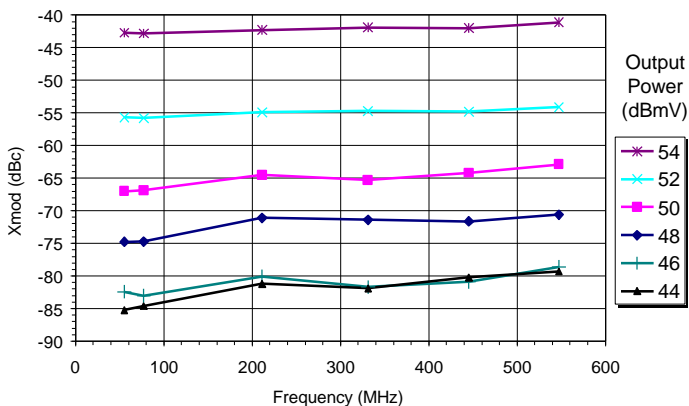

CTB VS. FREQUENCY
110 CHANNEL LOADING, FLAT

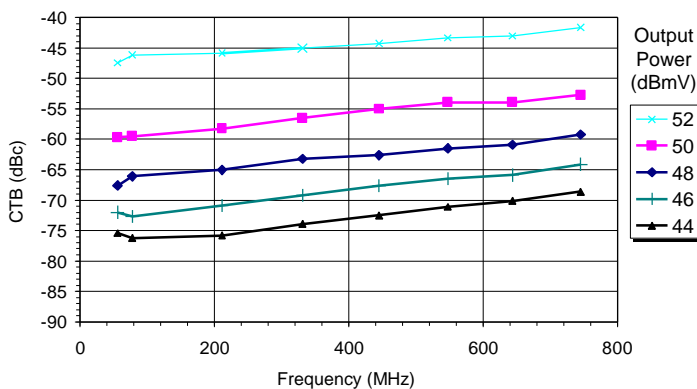

CSO VS. FREQUENCY
110 CHANNEL LOADING, FLAT

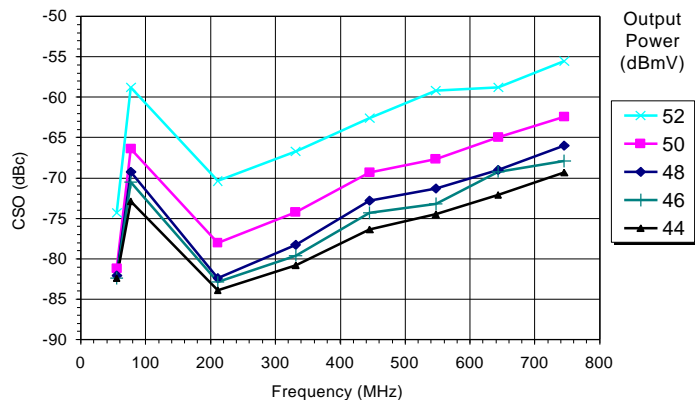

XMOD VS. FREQUENCY
110 CHANNEL LOADING, FLAT

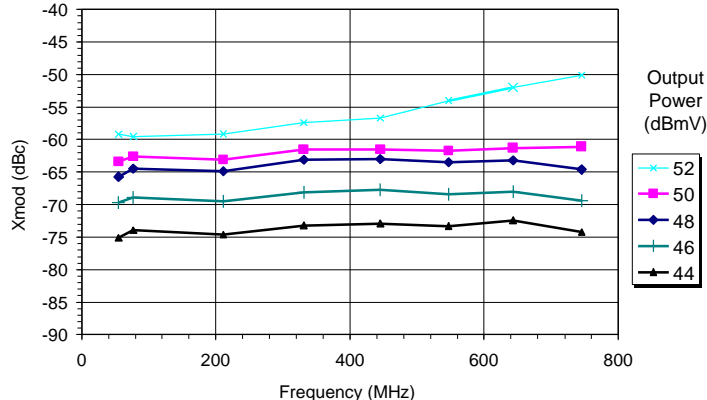

ACA0861C AND ACA0861D CASCADE TYPICAL DATA

(SEE FIGURE)

CTB VS. FREQUENCY
128 CHANNEL LOADING, FLAT

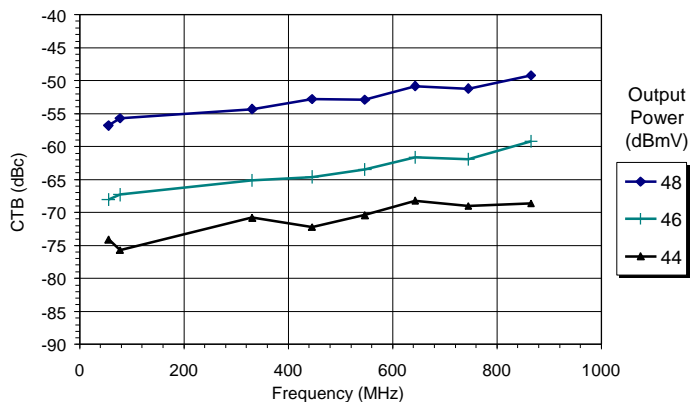

CSO VS. FREQUENCY
128 CHANNEL LOADING, FLAT

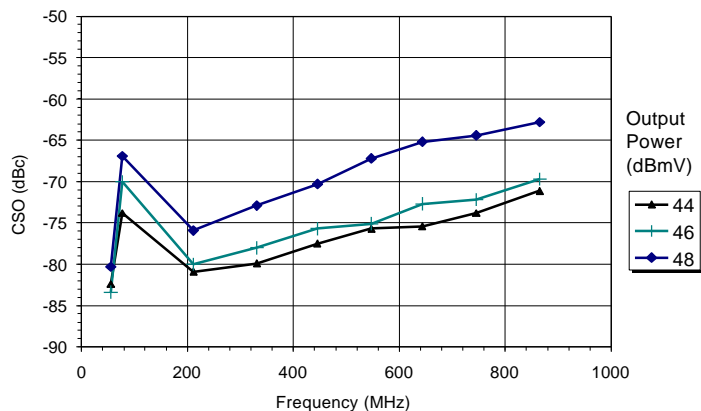

XMOD VS. FREQUENCY
128 CHANNEL LOADING, FLAT

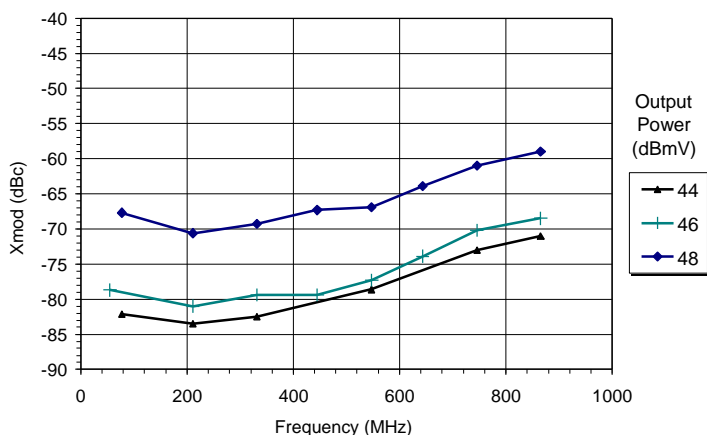

CTB VS. FREQUENCY
77 CHANNEL LOADING, 8dB TILT

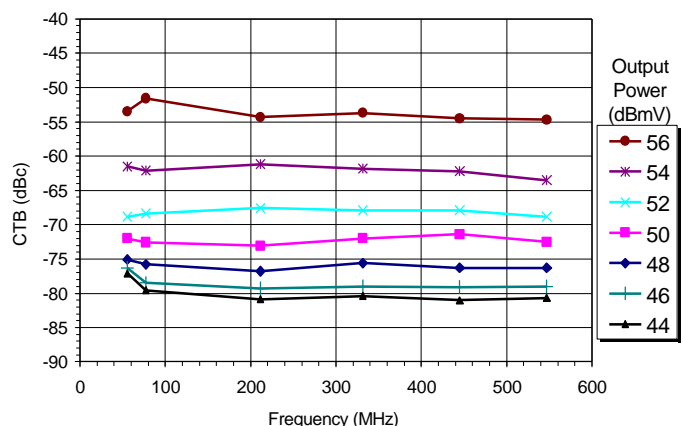

CSO VS. FREQUENCY
77 CHANNEL LOADING, 8 dB TILT

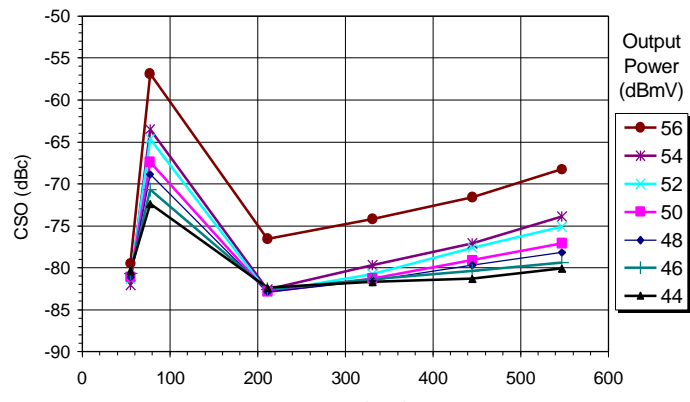

XMOD VS. FREQUENCY
77 CHANNEL LOADING, 8dB TILT

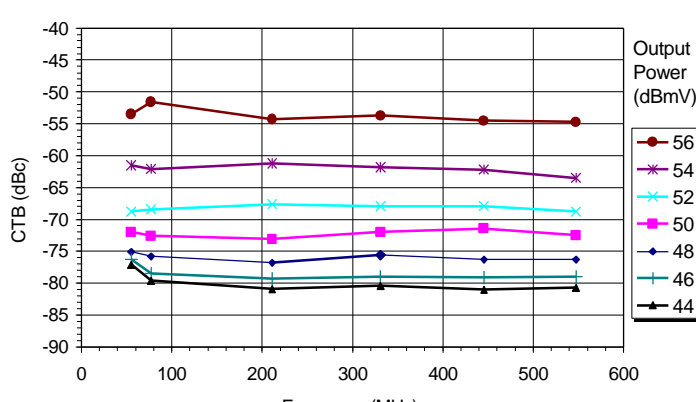

ACA0861C AND ACA0861D CASCADE TYPICAL DATA (SEE FIGURE)

CTB VS. FREQUENCY
110 CHANNEL LOADING, 10dB TILT

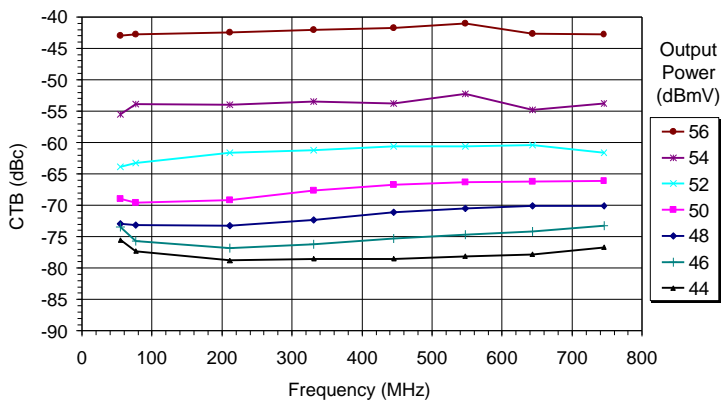

CSO VS. FREQUENCY
110 CHANNEL LOADING, 10dB TILT

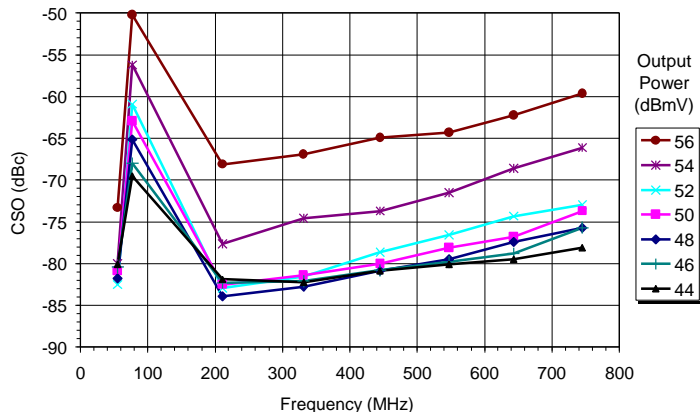

XMOD VS. FREQUENCY
110 CHANNEL LOADING, 10dB TILT

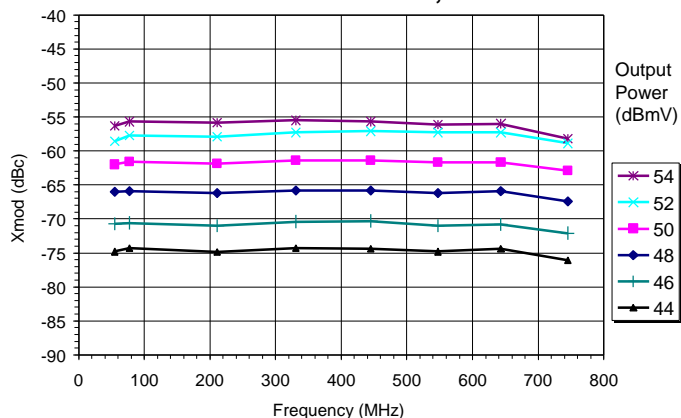

CTB VS. FREQUENCY
128 CHANNEL LOADING, 12dB TILT

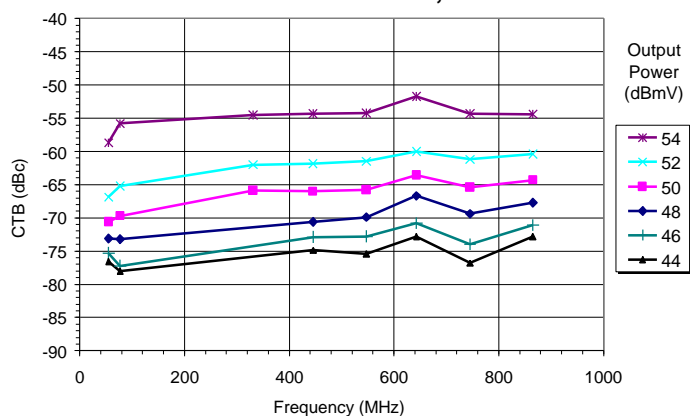

CSO VS. FREQUENCY
128 CHANNEL LOADING, 12dB TILT

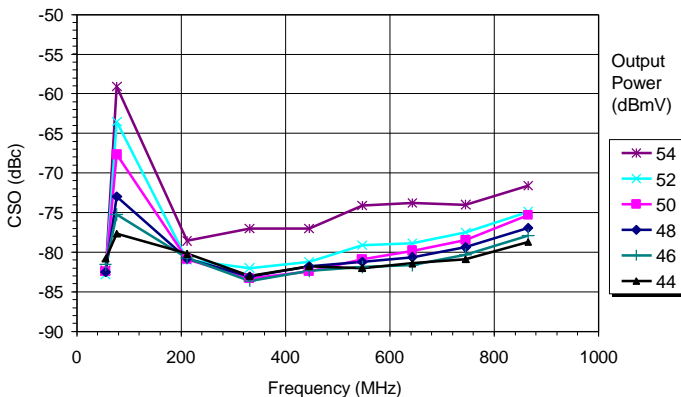

XMOD VS. FREQUENCY
128 CHANNEL LOADING, 12dB TILT

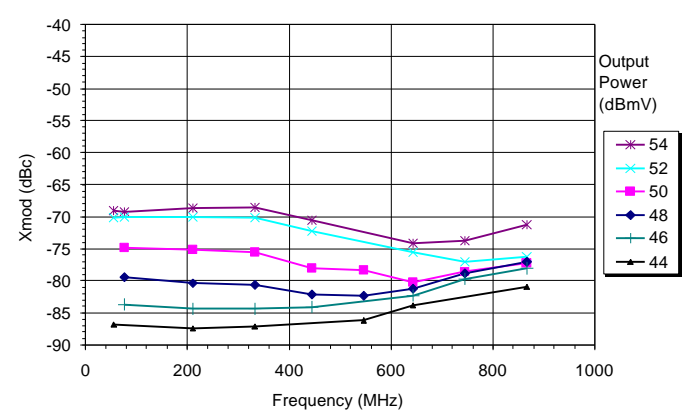

PIN	FUNCTION
1	GND
2	Leave Open
3	RF _{IN} #1
4	GND
5	GND
6	RF _{IN} #2
7	I _{ADJ} Resistor
8	GND
9	GND
10	+VD
11	RF _{OUT} #2
12	GND
13	GND
14	RF _{OUT} #1
15	+VD
16	GND

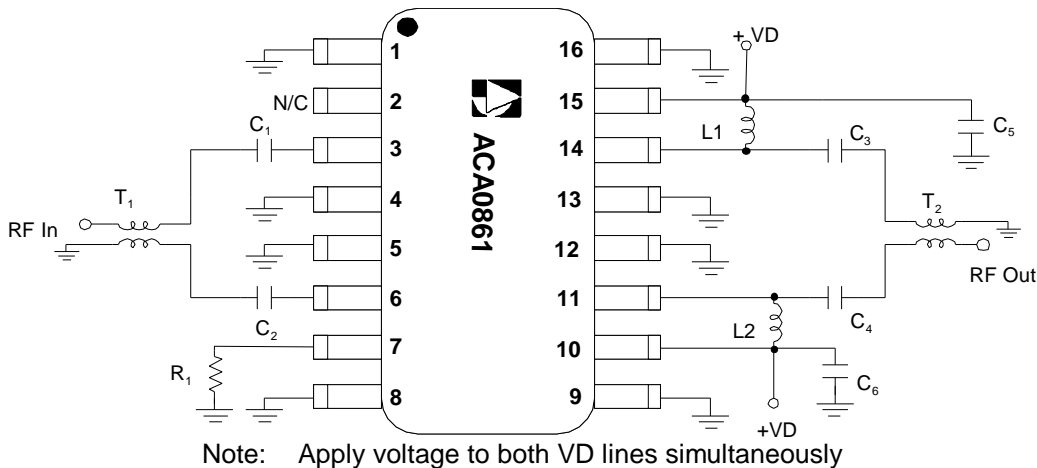

Figure 1. Test Circuit

TABLE I Current Set Resistor		PART LIST	
Part Suffix	R ₁	Designation	Description
ACA0861A	21.5 Ω	C1	.01μF
ACA0861B	274 Ω	C2	.01μF
ACA0861C	121 Ω	C3	300 pF
ACA0861D	OPEN	C4	300 pF
		C5	.01μF
		C6	.01μF
		R ₁	See Table I
		L1, L2	390 nH
		T ₁ , T ₂	5 Turns, 75 Ω Twin Lead Around Ferrite Core WIRE: MWS B2383611 CORE: Philips 135 CT 0503D3

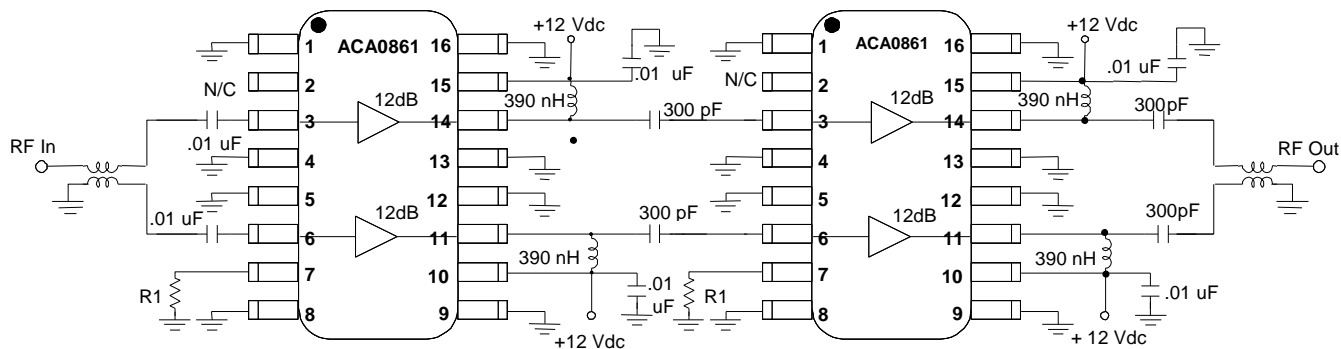
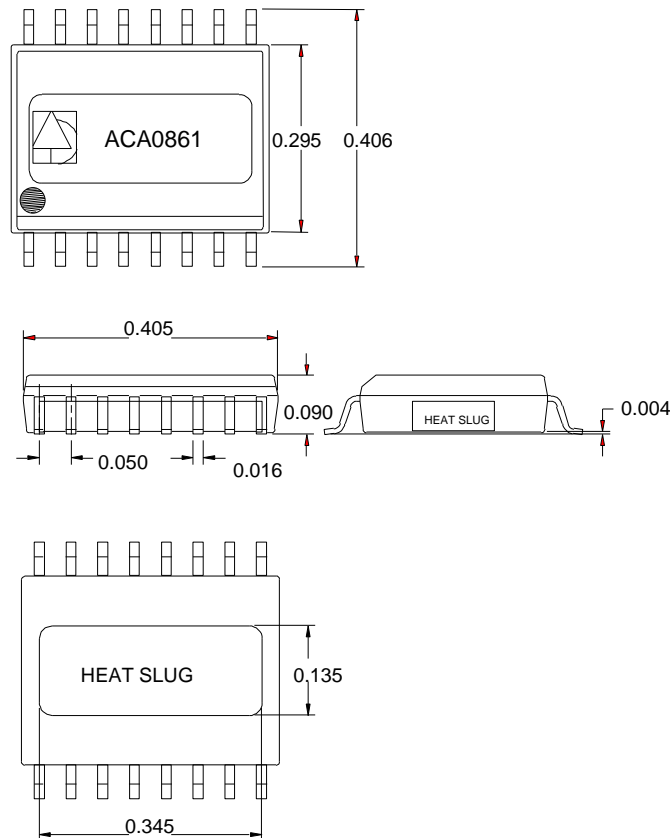

Figure 2. Hybrid Equivalent Test Circuit



Dimensions in inches

Figure 3 Package Dimensions

ANADIGICS, Inc.
 35 Technology Drive
 Warren, New Jersey 07059
 T: (908) 668-5000 F: (908) 668-5132
 Email: mrkg@anadigics.com

IMPORTANT

ANADIGICS reserves the right to make changes to its products or discontinue any product without notice. The Advanced Product data sheets and product specifications contained in this data sheet are subject to change prior to products formal introduction. The information in this book has been carefully checked and is assumed to be reliable. However, ANADIGICS strongly urges customers to verify that the information they are using is current before placing orders.

WARNING

ANADIGICS products are not intended for use in life support appliances, devices, or systems. Use of an ANADIGICS product in any such application without consent is prohibited.