

LM3671

2MHz, 600mA Step-Down DC-DC Converter

General Description

The LM3671 step-down DC-DC converter is optimized for powering low voltage circuits from a single Li-Ion cell battery and input voltage rails from 2.7V to 5.5V. It provides up to 600mA load current, over the entire input voltage range. There are several different fixed voltage output options available as well as an adjustable output voltage version range from 1.1V to 3.3V.

The device offers superior features and performance for mobile phones and similar portable systems. Automatic intelligent switching between PWM low-noise and PFM low-current mode offers improved system control. During PWM mode, the device operates at a fixed-frequency of 2 MHz (typ.). Hysteretic PFM mode extends the battery life by reducing the quiescent current to 16 μ A (typ.) during light load and standby operation. Internal synchronous rectification provides high efficiency during PWM mode operation. In shutdown mode, the device turns off and reduces battery consumption to 0.01 μ A (typ.).

The LM3671 is available in SOT23-5, tiny 5-bump micro SMD and a 6-pin LLP packages in leaded (PB) and lead-free (NO PB) versions. A high switching frequency of 2 MHz (typ.) allows use of tiny surface-mount components. Only three external surface-mount components, an inductor and two ceramic capacitors, are required.

Features

- 16 μ A typical quiescent current
- 600 mA maximum load capability
- 2 MHz PWM fixed switching frequency (typ.)
- Automatic PFM/PWM mode switching
- Internal synchronous rectification for high efficiency
- Internal soft start
- 0.01 μ A typical shutdown current
- Operates from a single Li-Ion cell battery
- Only three tiny surface-mount external components required (one inductor, two ceramic capacitors)
- Current overload and Thermal shutdown protection
- Available in fixed output voltages and adjustable version
- SOT23-5, 5-bump micro SMD and 6-pin LLP packages

Applications

- Mobile phones
- PDAs
- MP3 players
- W-LAN
- Portable instruments
- Digital still cameras
- Portable Hard disk drives

Typical Application Circuits

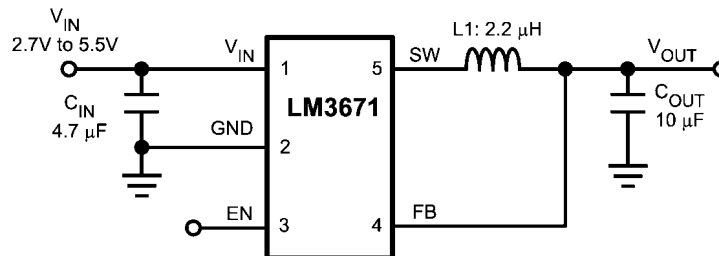

20108401

FIGURE 1. Typical Application Circuit

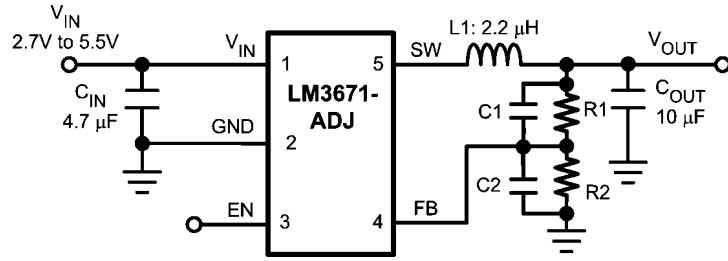

20108431

FIGURE 2. Typical Application Circuit for ADJ version

Connection Diagram and Package Mark Information

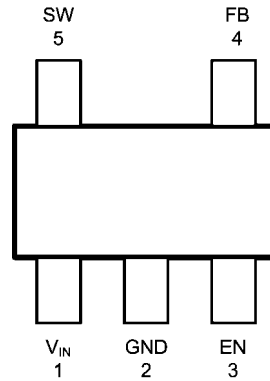

20108402

FIGURE 3. Top View
SOT23-5 Package NS Package Number MF05A (2.92mm x 2.84mm x 1.2mm)

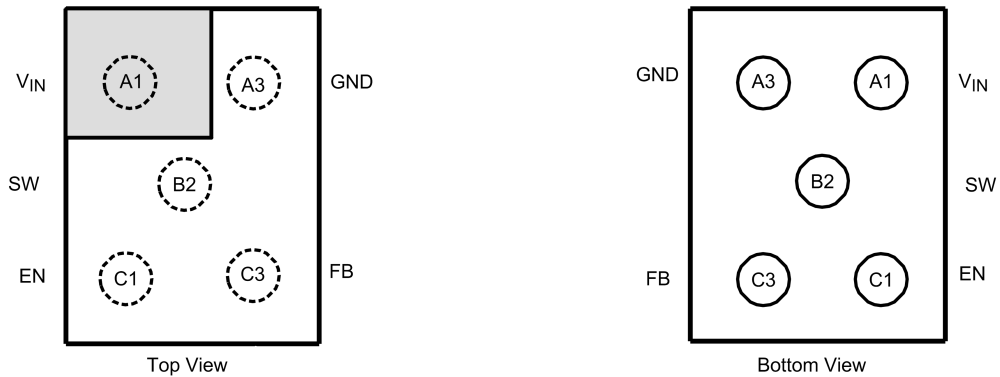

20108444

FIGURE 4. 5-Bump Micro SMD Package NS Package Number TLA05CBA (1.05mm x 1.38mm x 0.6mm)

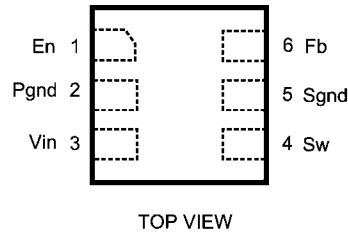

FIGURE 5. 6-Pin LLP Package Number LCA06B (2mm x 2mm x 0.6mm)

Pin Descriptions (SOT23-5)

Pin #	Name	Description
1	V_{IN}	Power supply input. Connect to the input filter capacitor (<i>Figure 1</i>).
2	GND	Ground pin.
3	EN	Enable pin. The device is in shutdown mode when voltage to this pin is $<0.4V$ and enabled when $>1.0V$. Do not leave this pin floating.
4	FB	Feedback analog input. Connect directly to the output filter capacitor for fixed voltage versions. For adjustable version external resistor dividers are required (<i>Figure 2</i>). The internal resistor dividers are disabled for the adjustable version.
5	SW	Switching node connection to the internal PFET switch and NFET synchronous rectifier.

Pin Descriptions (5-Bump Micro SMD)

Pin #	Name	Description
A1	V_{IN}	Power supply input. Connect to the input filter capacitor (<i>Figure 1</i>).
A3	GND	Ground pin.
C1	EN	Enable pin. The device is in shutdown mode when voltage to this pin is $<0.4V$ and enabled when $>1.0V$. Do not leave this pin floating.
C3	FB	Feedback analog input. Connect directly to the output filter capacitor for fixed voltage versions. For adjustable version external resistor dividers are required (<i>Figure 2</i>). The internal resistor dividers are disabled for the adjustable version.
B2	SW	Switching node connection to the internal PFET switch and NFET synchronous rectifier.

Pin Descriptions (6-Pin LLP)

Pin #	Name	Description
1	EN	Enable pin. The device is in shutdown mode when voltage to this pin is $<0.4V$ and enabled when $>1.0V$. Do not leave this pin floating.
2	Pgnd	Ground pin.
3	V_{IN}	Power supply input. Connect to the input filter capacitor ().
4	SW	Switching node connection to the internal PFET switch and NFET synchronous rectifier.
5	Sgnd	Singnal ground (feedback ground).
6	FB	Feedback analog input. Connect directly to the output filter capacitor for fixed voltage versions. For adjustable version external resistor dividers are required (<i>Figure 2</i>). The internal resistor dividers are disabled for the adjustable version.

Ordering Information (SOT23-5)

Voltage Option	Order Number	Spec	Package Marking	Supplied As
ADJ	LM3671MF-ADJ	NOPB	SBTB	1000 units, Tape-and-Reel
	LM3671MFX-ADJ	NOPB		3000 units, Tape-and-Reel
	LM3671MF-ADJ			1000 units, Tape-and-Reel
	LM3671MFX-ADJ			3000 units, Tape-and-Reel
1.2	LM3671MF-1.2	NOPB	SBPB	1000 units, Tape-and-Reel
	LM3671MFX-1.2	NOPB		3000 units, Tape-and-Reel
	LM3671MF-1.2			1000 units, Tape-and-Reel
	LM3671MFX-1.2			3000 units, Tape-and-Reel
1.25	LM3671MF-1.25	NOPB	SDRB	1000 units, Tape-and-Reel
	LM3671MFX-1.25	NOPB		3000 units, Tape-and-Reel
	LM3671MF-1.25			1000 units, Tape-and-Reel
	LM3671MFX-1.25			3000 units, Tape-and-Reel
1.375	LM3671MF-1.375	NOPB	SEDB	1000 units, Tape-and-Reel
	LM3671MFX-1.375	NOPB		3000 units, Tape-and-Reel
	LM3671MF-1.375			1000 units, Tape-and-Reel
	LM3671MFX-1.375			3000 units, Tape-and-Reel
1.5	LM3671MF-1.5	NOPB	SBRB	1000 units, Tape-and-Reel
	LM3671MFX-1.5	NOPB		3000 units, Tape-and-Reel
	LM3671MF-1.5			1000 units, Tape-and-Reel
	LM3671MFX-1.5			3000 units, Tape-and-Reel
1.6	LM3671MF-1.6	NOPB	SDUB	1000 units, Tape-and-Reel
	LM3671MFX-1.6	NOPB		3000 units, Tape-and-Reel
	LM3671MF-1.6			1000 units, Tape-and-Reel
	LM3671MFX-1.6			3000 units, Tape-and-Reel
1.8	LM3671MF-1.8	NOPB	SBSB	1000 units, Tape-and-Reel
	LM3671MFX-1.8	NOPB		3000 units, Tape-and-Reel
	LM3671MF-1.8			1000 units, Tape-and-Reel
	LM3671MFX-1.8			3000 units, Tape-and-Reel
1.875	LM3671MF-1.875	NOPB	SDVB	1000 units, Tape-and-Reel
	LM3671MFX-1.875	NOPB		3000 units, Tape-and-Reel
	LM3671MF-1.875			1000 units, Tape-and-Reel
	LM3671MFX-1.875			3000 units, Tape-and-Reel
2.5	LM3671MF-2.5	NOPB	SJRB	1000 units, Tape-and-Reel
	LM3671MFX-2.5	NOPB		3000 units, Tape-and-Reel
	LM3671MF-2.5			1000 units, Tape-and-Reel
	LM3671MFX-2.5			3000 units, Tape-and-Reel
2.8	LM3671MF-2.8	NOPB	SJSB	1000 units, Tape-and-Reel
	LM3671MFX-2.8	NOPB		3000 units, Tape-and-Reel
	LM3671MF-2.8			1000 units, Tape-and-Reel
	LM3671MFX-2.8			3000 units, Tape-and-Reel
3.3	LM3671MF-3.3	NOPB	SJEB	1000 units, Tape-and-Reel
	LM3671MFX-3.3	NOPB		3000 units, Tape-and-Reel
	LM3671MF-3.3			1000 units, Tape-and-Reel
	LM3671MFX-3.3			3000 units, Tape-and-Reel

Ordering Information (5-bump Micro SMD)

Voltage Option	Order Number	Spec	Package Marking	Supplied As
ADJ	LM3671TL-ADJ	NOPB	E	250 units, Tape-and-Reel
	LM3671TLX-ADJ	NOPB		3000 units, Tape-and-Reel
	LM3671TL-ADJ			250 units, Tape-and-Reel
	LM3671TLX-ADJ			3000 units, Tape-and-Reel
1.2	LM3671TL-1.2	NOPB	C	250 units, Tape-and-Reel
	LM3671TLX-1.2	NOPB		3000 units, Tape-and-Reel
	LM3671TL-1.2			250 units, Tape-and-Reel
	LM3671TLX-1.2			3000 units, Tape-and-Reel
1.5	LM3671TL-1.5	NOPB	D	250 units, Tape-and-Reel
	LM3671TLX-1.5	NOPB		3000 units, Tape-and-Reel
	LM3671TL-1.5			250 units, Tape-and-Reel
	LM3671TLX-1.5			3000 units, Tape-and-Reel
1.8	LM3671TL-1.8	NOPB	B	250 units, Tape-and-Reel
	LM3671TLX-1.8	NOPB		3000 units, Tape-and-Reel
	LM3671TL-1.8			250 units, Tape-and-Reel
	LM3671TLX-1.8			3000 units, Tape-and-Reel
1.875	LM3671TL-1.875	NOPB	S	250 units, Tape-and-Reel
	LM3671TLX-1.875	NOPB		3000 units, Tape-and-Reel
	LM3671TL-1.875			250 units, Tape-and-Reel
	LM3671TLX-1.875			3000 units, Tape-and-Reel
2.5	LM3671TL-2.5	NOPB	L	250 units, Tape-and-Reel
	LM3671TLX-2.5	NOPB		3000 units, Tape-and-Reel
	LM3671TL-2.5			250 units, Tape-and-Reel
	LM3671TLX-2.5			3000 units, Tape-and-Reel
2.8	LM3671TL-2.8	NOPB	K	250 units, Tape-and-Reel
	LM3671TLX-2.8	NOPB		3000 units, Tape-and-Reel
	LM3671TL-2.8			250 units, Tape-and-Reel
	LM3671TLX-2.8			3000 units, Tape-and-Reel
3.3	LM3671TL-3.3	NOPB	J	250 units, Tape-and-Reel
	LM3671TLX-3.3	NOPB		3000 units, Tape-and-Reel
	LM3671TL-3.3			250 units, Tape-and-Reel
	LM3671TLX-3.3			3000 units, Tape-and-Reel

Ordering Information (6-Pin LLP)

Voltage Option	Order Number	Spec	Package Marking	Supplied As
1.2	LM3671LC-1.2	NOPB	S39	1000 units, Tape-and-Reel
	LM3671LCX-1.2	NOPB		4500 units, Tape-and-Reel
1.3	LM3671LC-1.3	NOPB	S40	1000 units, Tape-and-Reel
	LM3671LCX-1.3	NOPB		4500 units, Tape-and-Reel
1.6	LM3671LC-1.6	NOPB	S41	1000 units, Tape-and-Reel
	LM3671LCX-1.6	NOPB		4500 units, Tape-and-Reel
1.8	LM3671LC-1.8	NOPB	S42	1000 units, Tape-and-Reel
	LM3671LCX-1.8	NOPB		4500 units, Tape-and-Reel

Absolute Maximum Ratings (Note 1)

If Military/Aerospace specified devices are required, please contact the National Semiconductor Sales Office/Distributors for availability and specifications.

V_{IN} Pin: Voltage to GND	-0.2V to 6.0V
FB, SW, EN Pin:	(GND-0.2V) to ($V_{IN} + 0.2V$)
Continuous Power Dissipation (Note 3)	Internally Limited
Junction Temperature (T_{J-MAX})	+125°C
Storage Temperature Range	-65°C to +150°C
Maximum Lead Temperature (Soldering, 10 sec.)	260°C
ESD Rating (Note 4)	
Human Body Model	2 kV
Machine Model	200V

Operating Ratings (Notes 1, 2)

Input Voltage Range (Note 10)	2.7V to 5.5V
Recommended Load Current	0mA to 600 mA
Junction Temperature (T_J) Range	-30°C to +125°C
Ambient Temperature (T_A) Range (Note 5)	-30°C to +85°C

Electrical Characteristics (Notes 2, 8, 9) Limits in standard typeface are for $T_J = 25^\circ\text{C}$. Limits in **boldface** type apply over the full operating ambient temperature range ($-30^\circ\text{C} \leq T_A \leq +85^\circ\text{C}$). Unless otherwise noted, specifications apply to the LM3671MF/TL/LC with $V_{IN} = EN = 3.6V$

Symbol	Parameter	Condition	Min	Typ	Max	Units
V_{IN}	Input Voltage	(Note 10)	2.7		5.5	V
V_{FB}	Feedback Voltage (Fixed) MF	PWM mode (Note 12)	-4		+4	%
	Feedback Voltage (Fixed) TL		-2.5		+2.5	
	Feedback Voltage (Fixed) LC		-4		+4	
	Feedback Voltage (ADJ) MF (Note 11)	PWM mode (Note 12)	-4		+4	%
	Feedback Voltage (ADJ) TL		-2.5		+2.5	
	Line Regulation	$2.7V \leq V_{IN} \leq 5.5V$ $I_O = 10\text{ mA}$		0.031		%/V
	Load Regulation	$100\text{ mA} \leq I_O \leq 600\text{ mA}$ $V_{IN} = 3.6V$		0.0013		%/mA
V_{REF}	Internal Reference Voltage			0.5		V
I_{SHDN}	Shutdown Supply Current	EN = 0V		0.01	1	μA
I_Q	DC Bias Current into V_{IN}	No load, device is not switching (FB forced higher than programmed output voltage)		16	35	μA
$R_{DSON(P)}$	Pin-Pin Resistance for PFET	$V_{IN} = V_{GS} = 3.6V$		380	500	m Ω
$R_{DSON(N)}$	Pin-Pin Resistance for NFET	$V_{IN} = V_{GS} = 3.6V$		250	400	m Ω
I_{LIM}	Switch Peak Current Limit	Open Loop (Note 7)	830	1020	1150	mA
V_{IH}	Logic High Input		1.0			V
V_{IL}	Logic Low Input				0.4	V
I_{EN}	Enable (EN) Input Current			0.01	1	μA
F_{OSC}	Internal Oscillator Frequency	PWM Mode (Note 12)	1.6	2	2.6	MHz

Note 1: Absolute Maximum Ratings indicate limits beyond which damage to the device may occur. Operating Ratings are conditions under which operation of the device is guaranteed. Operating Ratings do not imply guaranteed performance limits. For guaranteed performance limits and associated test conditions, see the Electrical Characteristics tables.

Note 2: All voltages are with respect to the potential at the GND pin.

Note 3: Internal thermal shutdown circuitry protects the device from permanent damage. Thermal shutdown engages at $T_J = 150^\circ\text{C}$ (typ.) and disengages at $T_J = 130^\circ\text{C}$ (typ.).

Note 4: The Human body model is a 100 pF capacitor discharged through a 1.5 k Ω resistor into each pin. The machine model is a 200 pF capacitor discharged directly into each pin. MIL-STD-883 3015.7

Note 5: In Applications where high power dissipation and/or poor package resistance is present, the maximum ambient temperature may have to be derated. Maximum ambient temperature (T_{A-MAX}) is dependent on the maximum operating junction temperature (T_{J-MAX}), the maximum power dissipation of the device in the application (P_{D-MAX}) and the junction to ambient thermal resistance of the package (θ_{JA}) in the application, as given by the following equation: $T_{A-MAX} = T_{J-MAX} - (\theta_{JA} \times P_{D-MAX})$. Refer to Dissipation rating table for P_{D-MAX} values at different ambient temperatures.

Note 6: Junction to ambient thermal resistance is highly application and board layout dependent. In applications where high power dissipation exists, special care must be given to thermal dissipation issues in board design. Specified value of 130 $^\circ\text{C}/\text{W}$ for SOT23-5 is based on a 4 layer, 4" x 3", 2/1/1/2 oz. Cu board as per JEDEC standards is used.

Note 7: Refer to datasheet curves for closed loop data and its variation with regards to supply voltage and temperature. Electrical Characteristic table reflects open loop data (FB=0V and current drawn from SW pin ramped up until cycle by cycle current limit is activated). Closed loop current limit is the peak inductor current measured in the application circuit by increasing output current until output voltage drops by 10%.

Note 8: Min and Max limits are guaranteed by design, test or statistical analysis. Typical numbers are not guaranteed, but do represent the most likely norm.

Note 9: The parameters in the electrical characteristic table are tested at $V_{IN} = 3.6\text{V}$ unless otherwise specified. For performance over the input voltage range refer to datasheet curves.

Note 10: The input voltage range recommended for ideal applications performance for the specified output voltages are given below:

$$V_{IN} = 2.7\text{V to } 4.5\text{V for } 1.1\text{V} \leq V_{OUT} < 1.5\text{V}$$

$$V_{IN} = 2.7\text{V to } 5.5\text{V for } 1.5\text{V} \leq V_{OUT} < 1.8\text{V}$$

$$V_{IN} = (V_{OUT} + V_{DROPOUT}) \text{ to } 5.5\text{V for } 1.8\text{V} \leq V_{OUT} \leq 3.3\text{V}$$

$$\text{where } V_{DROPOUT} = I_{LOAD} \times (R_{DS(ON), PFET} + R_{INDUCTOR})$$

Note 11: ADJ version is configured to 1.5V output. For ADJ output version:

$$V_{IN} = 2.7\text{V to } 4.5\text{V for } 0.90\text{V} \leq V_{OUT} < 1.1\text{V}$$

$$V_{IN} = 2.7\text{V to } 5.5\text{V for } 1.1\text{V} \leq V_{OUT} < 3.3\text{V}$$

Note 12: Test condition: for V_{OUT} less than 2.5V, $V_{IN} = 3.6\text{V}$; for V_{OUT} greater than or equal to 2.5V, $V_{IN} = V_{OUT} + 1\text{V}$.

Dissipation Rating Table

θ_{JA}	$T_A \leq 25^\circ\text{C}$ Power Rating	$T_A = 60^\circ\text{C}$ Power Rating	$T_A = 85^\circ\text{C}$ Power Rating
130 $^\circ\text{C}/\text{W}$ (4 layer board) SOT23-5	770mW	500mW	310mW
85 $^\circ\text{C}/\text{W}$ (4 layer board) 5-bump Micro SMD	1179mW	765mW	470mW
165 $^\circ\text{C}/\text{W}$ (4 layer board) 6-pin LLP	606mW	394mW	242mW

Block Diagram

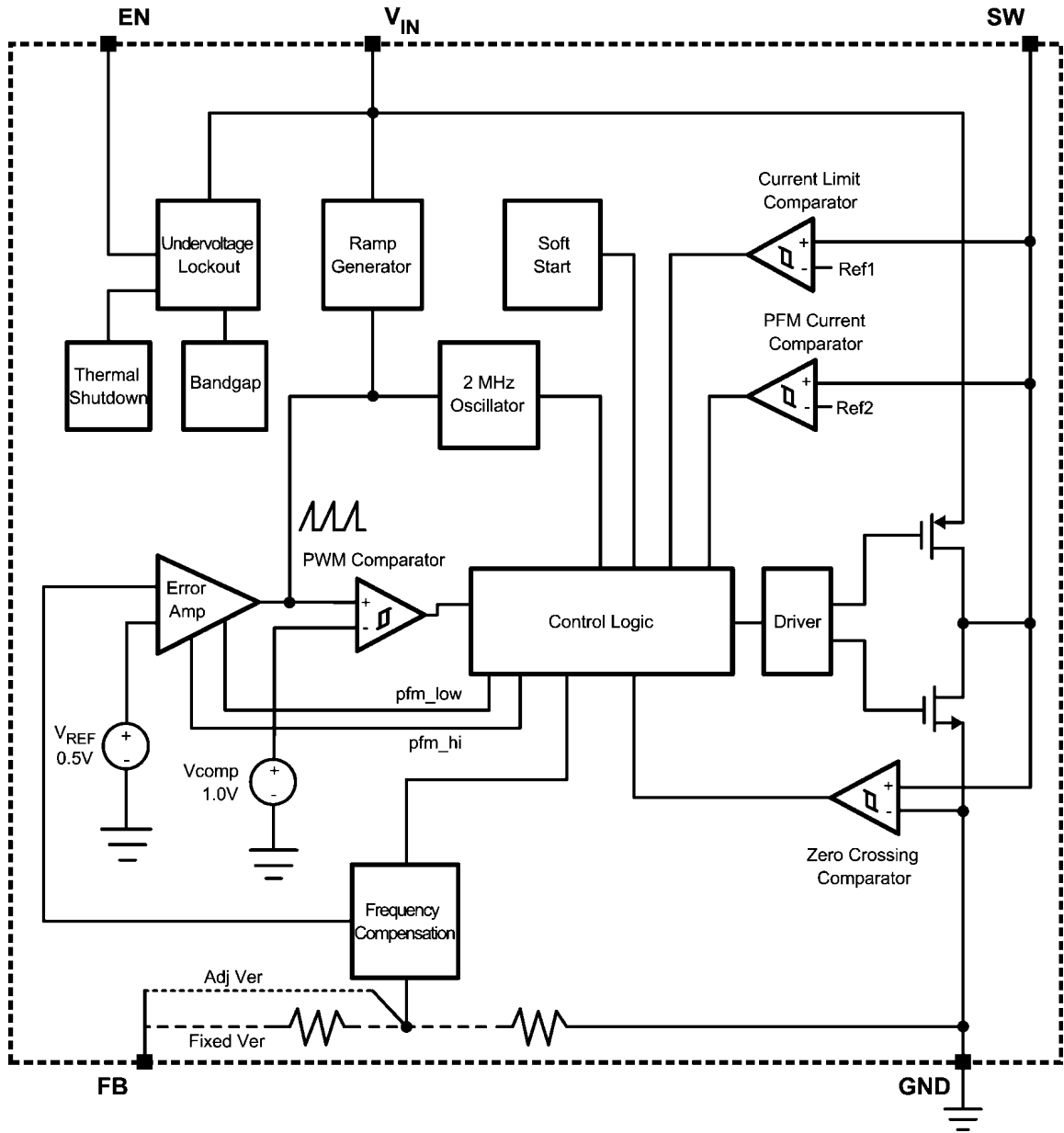

20108418

FIGURE 6. Simplified Functional Diagram

Typical Performance Characteristics

LM3671MF/TL/LC, Circuit of Figure 1, $V_{IN} = 3.6V$, $V_{OUT} = 1.5V$, $T_A = 25^\circ C$, unless otherwise noted.

Quiescent Supply Current vs. Supply Voltage

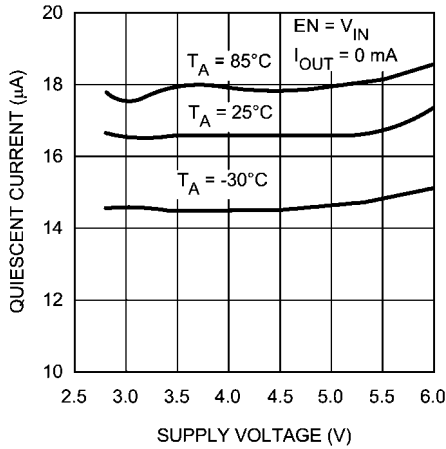

20108404

Shutdown Current vs. Temp

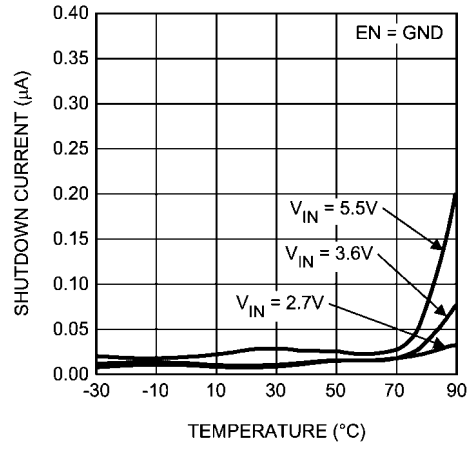

20108405

Feedback Bias Current vs. Temp

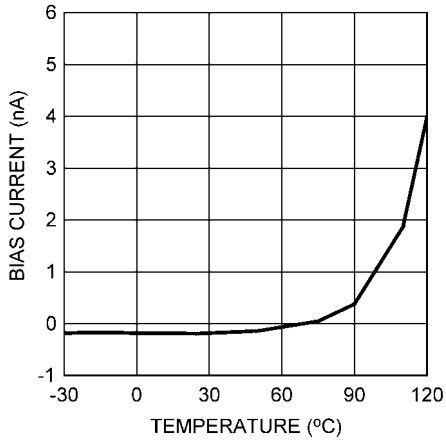

20108440

Switching Frequency vs. Temperature

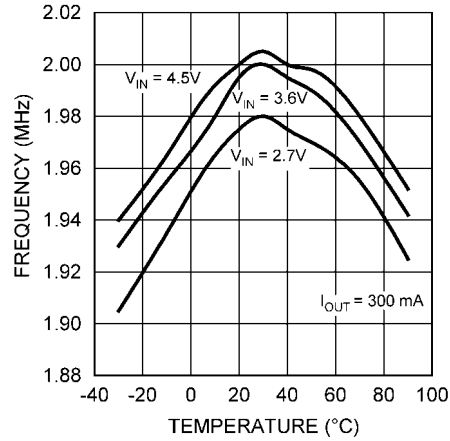

20108447

$R_{DS(ON)}$ vs. Temperature

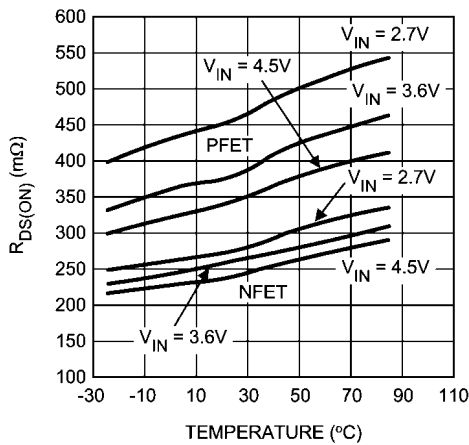

20108433

Open/Closed Loop Current Limit vs. Temperature

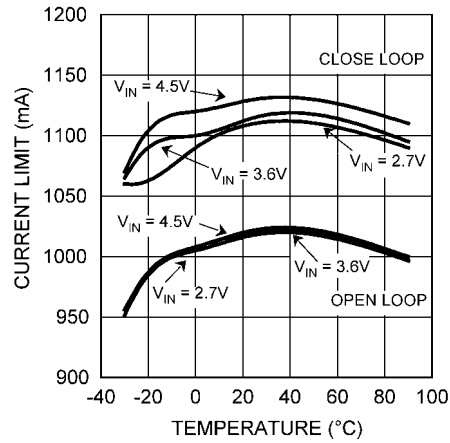

20108448

Output Voltage vs. Supply Voltage
($V_{OUT} = 1.5V$)

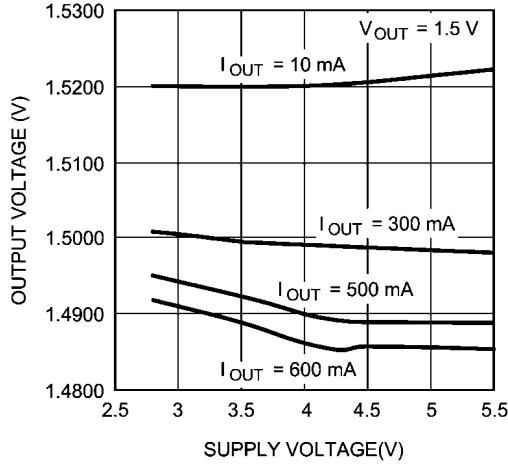

20108429

Output Voltage vs. Supply Voltage
($V_{OUT} = 2.5V$)

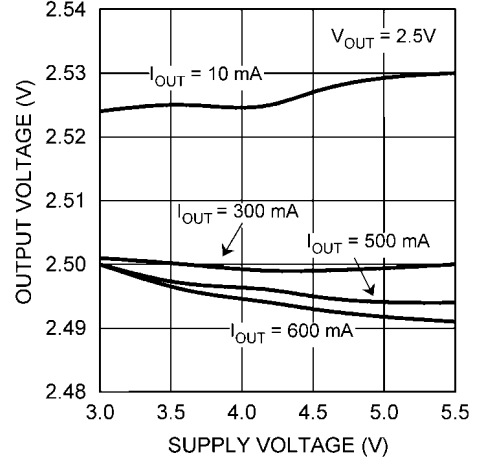

20108458

Output Voltage vs. Temperature
($V_{OUT} = 1.5V$)

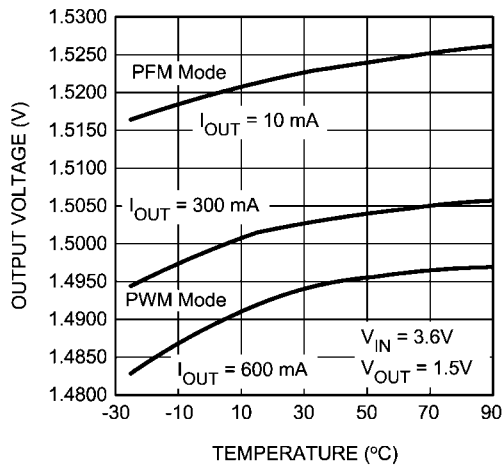

20108406

Output Voltage vs. Temperature
($V_{OUT} = 2.5V$)

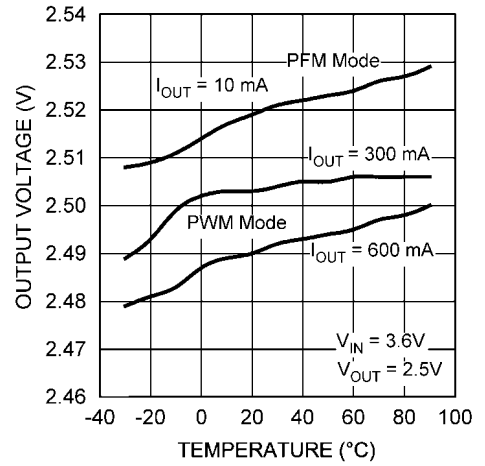

20108459

Output Voltage vs. Output Current
($V_{OUT} = 1.5V$)

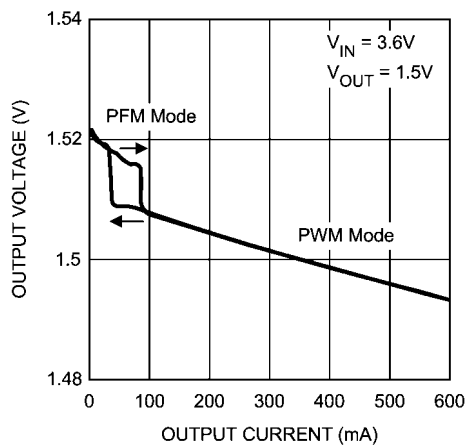

20108407

Output Voltage vs. Output Current
($V_{OUT} = 2.5V$)

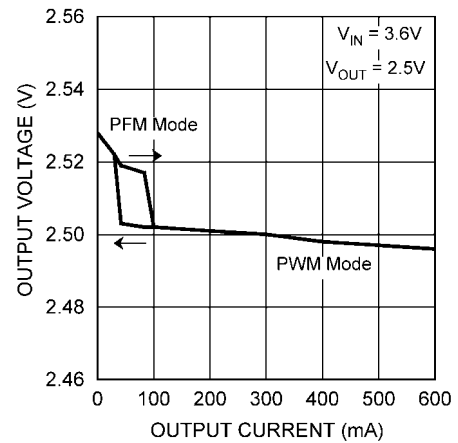

20108460

Efficiency vs. Output Current
($V_{OUT} = 1.5V$, $L = 2.2 \mu H$)

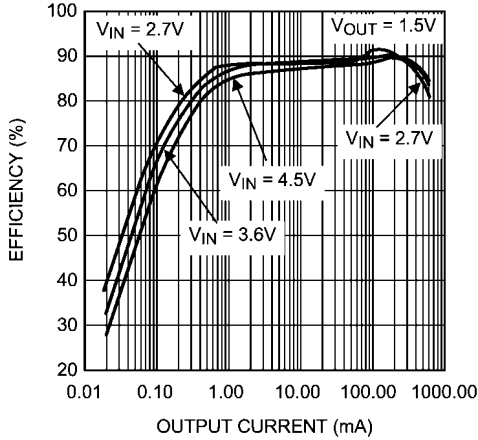

20108408

Efficiency vs. Output Current
($V_{OUT} = 1.8V$, $L = 2.2 \mu H$)

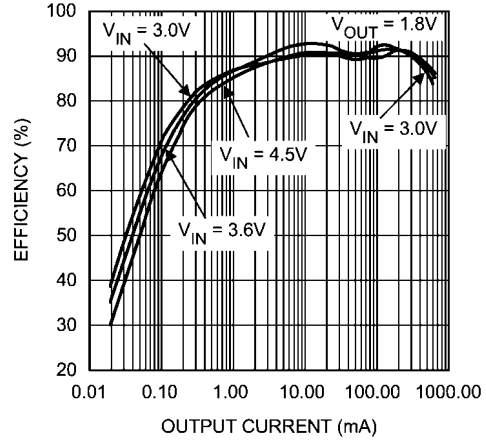

20108409

Efficiency vs. Output Current
($V_{OUT} = 2.5V$, $L = 2.2 \mu H$)

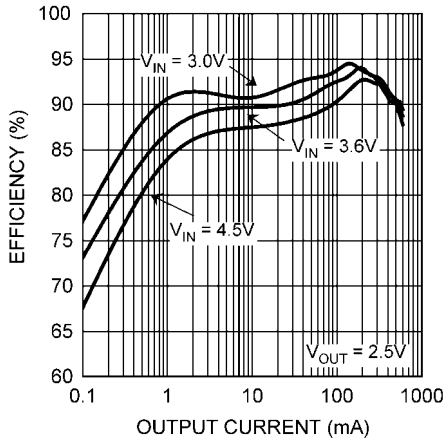

20108441

Efficiency vs. Output Current
($V_{OUT} = 3.3V$, $L = 2.2 \mu H$)

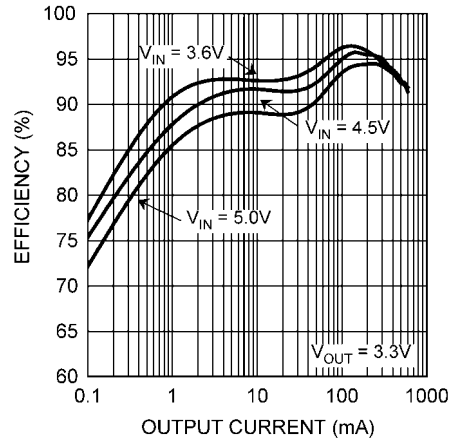

20108442

Line Transient Response
 $V_{OUT} = 1.5V$ (PWM Mode)

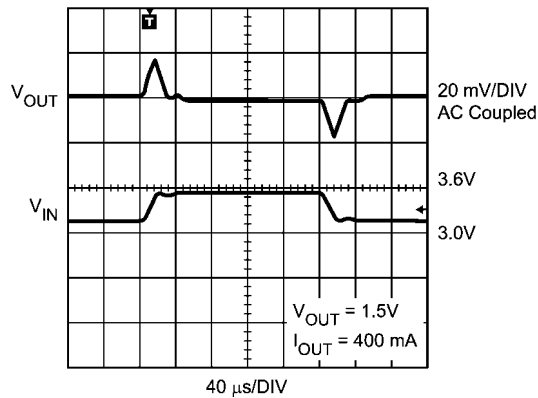

20108412

Line Transient Response
 $V_{OUT} = 2.5V$ (PWM Mode)

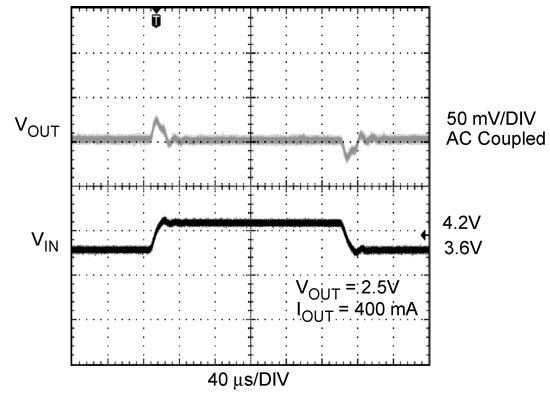

20108450

Load Transient Response
 $V_{OUT} = 1.5V$ (PWM Mode)

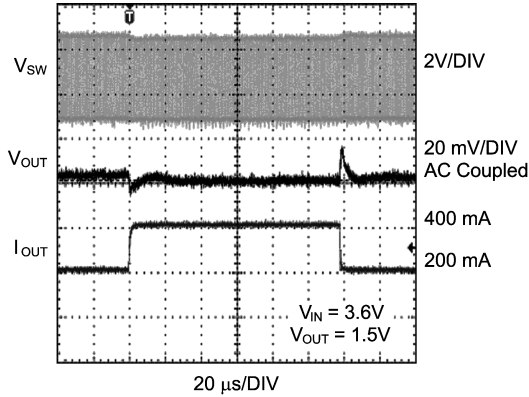

Load Transient Response
 $V_{OUT} = 2.5V$ (PWM Mode)

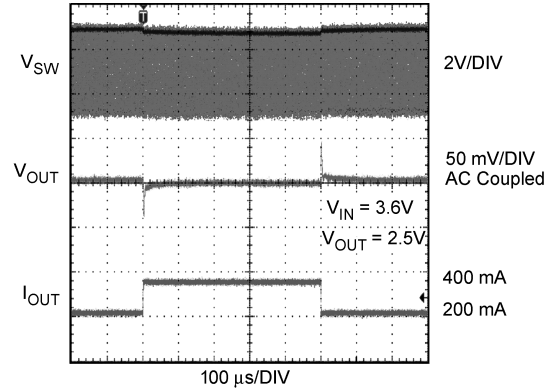

Load Transient Response ($V_{OUT} = 1.5V$)
(PFM Mode 0.5mA to 50mA)

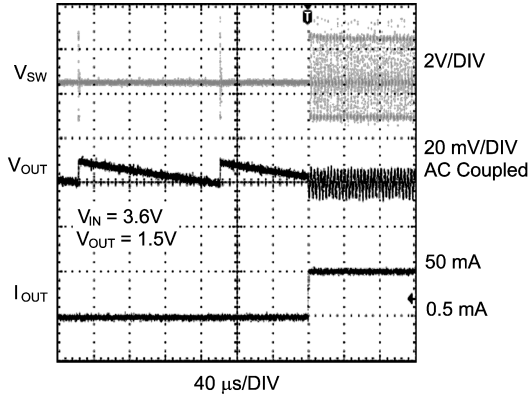

Load Transient Response ($V_{OUT} = 1.5V$)
(PFM Mode 50mA to 0.5mA)

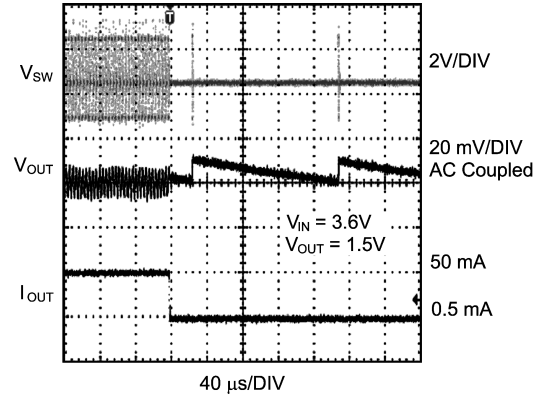

Load Transient Response ($V_{OUT} = 2.5V$)
(PFM Mode 0.5mA to 50mA)

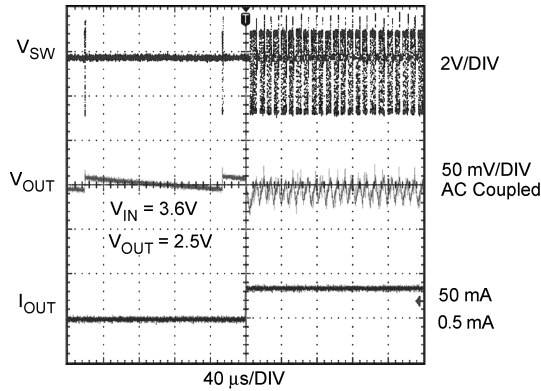

Load Transient Response ($V_{OUT} = 2.5V$)
(PFM Mode 50mA to 0.5mA)

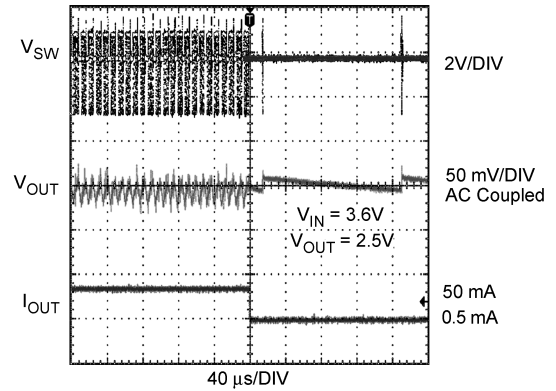

Mode Change by Load Transients
 $V_{OUT} = 1.5V$ (PFM to PWM)

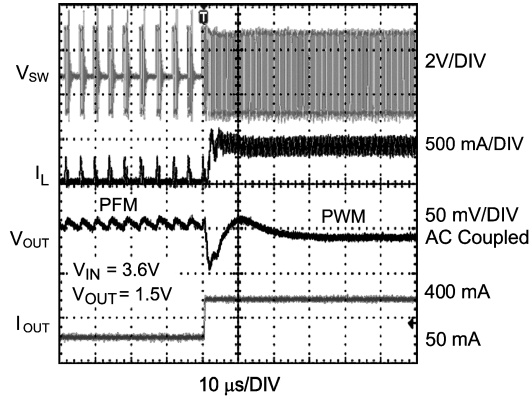

20108420

Mode Change by Load Transients
 $V_{OUT} = 1.5V$ (PWM to PFM)

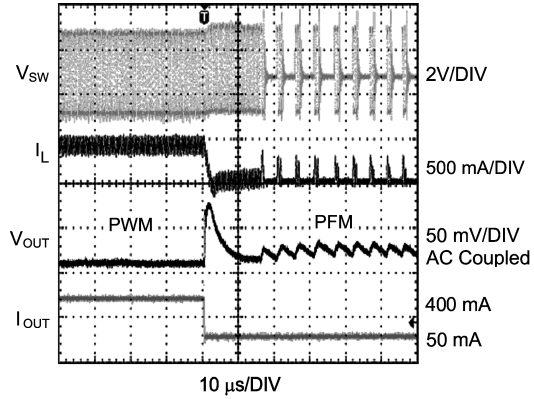

20108421

Mode Change by Load Transients
 $V_{OUT} = 2.5V$ (PFM to PWM)

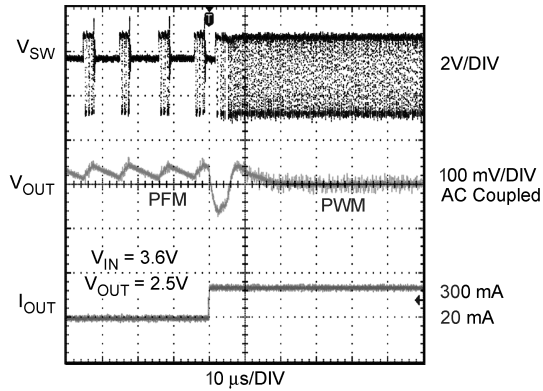

20108454

Mode Change by Load Transients
 $V_{OUT} = 2.5V$ (PWM to PFM)

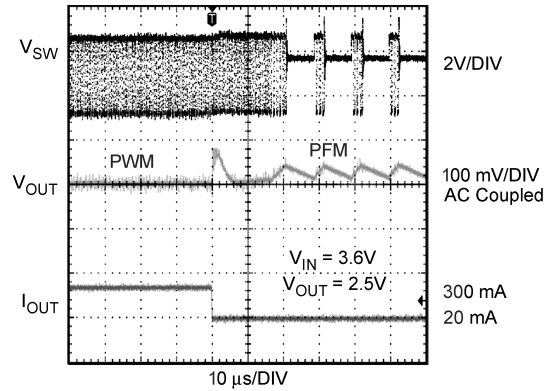

20108455

Start Up into PWM Mode
 $V_{OUT} = 1.5V$ (Output Current= 300mA)

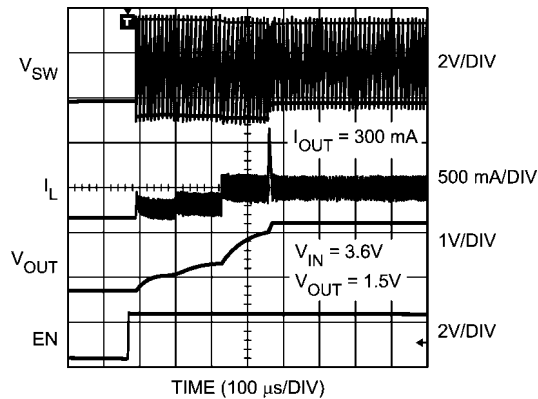

20108424

Start Up into PWM Mode
 $V_{OUT} = 2.5V$ (Output Current= 300mA)

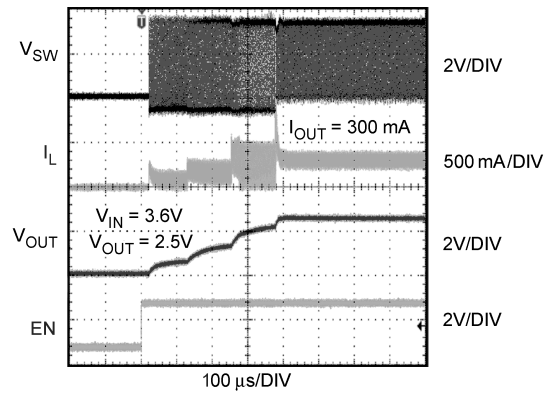

20108456

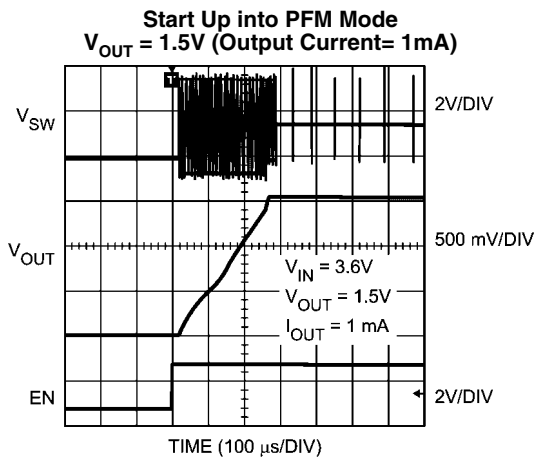

20108419

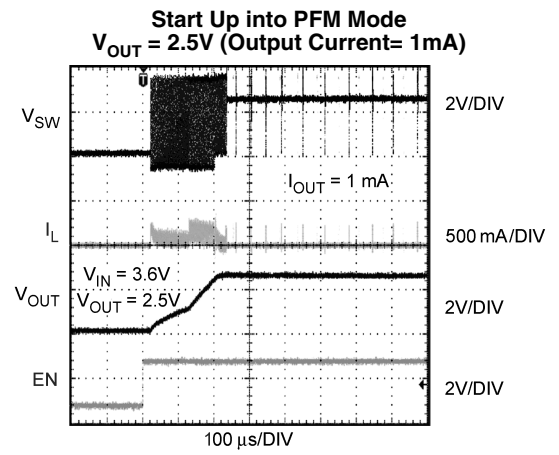

20108457

Operation Description

DEVICE INFORMATION

The LM3671, a high efficiency step down DC-DC switching buck converter, delivers a constant voltage from a single Li-Ion battery and input voltage rails from 2.7V to 5.5V to portable devices such as cell phones and PDAs. Using a voltage mode architecture with synchronous rectification, the LM3671 has the ability to deliver up to 600 mA depending on the input voltage, output voltage, ambient temperature and the inductor chosen.

There are three modes of operation depending on the current required - PWM (Pulse Width Modulation), PFM (Pulse Frequency Modulation), and shutdown. The device operates in PWM mode at load current of approximately 80 mA or higher. Lighter load current cause the device to automatically switch into PFM for reduced current consumption ($I_Q = 16 \mu\text{A}$ typ) and a longer battery life. Shutdown mode turns off the device, offering the lowest current consumption ($I_{\text{SHUTDOWN}} = 0.01 \mu\text{A}$ typ).

Additional features include soft-start, under voltage protection, current overload protection, and thermal shutdown protection. As shown in *Figure 1*, only three external power components are required for implementation.

The part uses an internal reference voltage of 0.5V. It is recommended to keep the part in shutdown until the input voltage is 2.7V or higher.

CIRCUIT OPERATION

During the first portion of each switching cycle, the control block in the LM3671 turns on the internal PFET switch. This allows current to flow from the input through the inductor to the output filter capacitor and load. The inductor limits the current to a ramp with a slope of $(V_{\text{IN}} - V_{\text{OUT}})/L$, by storing energy in a magnetic field.

During the second portion of each cycle, the controller turns the PFET switch off, blocking current flow from the input, and then turns the NFET synchronous rectifier on. The inductor draws current from ground through the NFET to the output filter capacitor and load, which ramps the inductor current down with a slope of $-V_{\text{OUT}}/L$.

The output filter stores charge when the inductor current is high, and releases it when inductor current is low, smoothing the voltage across the load.

The output voltage is regulated by modulating the PFET switch on time to control the average current sent to the load. The effect is identical to sending a duty-cycle modulated rectangular wave formed by the switch and synchronous rectifier at the SW pin to a low-pass filter formed by the inductor and output filter capacitor. The output voltage is equal to the average voltage at the SW pin.

PWM OPERATION

During PWM operation the converter operates as a voltage-mode controller with input voltage feed forward. This allows the converter to achieve good load and line regulation. The DC gain of the power stage is proportional to the input voltage. To eliminate this dependence, feed forward inversely proportional to the input voltage is introduced.

While in PWM mode, the output voltage is regulated by switching at a constant frequency and then modulating the energy per cycle to control power to the load. At the beginning of each clock cycle the PFET switch is turned on and the inductor current ramps up until the comparator trips and the control logic turns off the switch. The current limit comparator

can also turn off the switch in case the current limit of the PFET is exceeded. Then the NFET switch is turned on and the inductor current ramps down. The next cycle is initiated by the clock turning off the NFET and turning on the PFET.

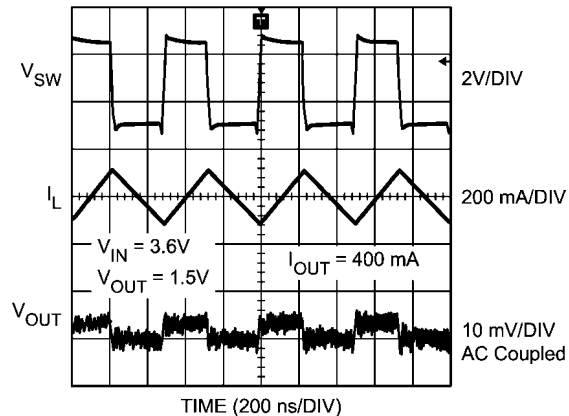

20108423

FIGURE 7. Typical PWM Operation

Internal Synchronous Rectification

While in PWM mode, the LM3671 uses an internal NFET as a synchronous rectifier to reduce rectifier forward voltage drop and associated power loss. Synchronous rectification provides a significant improvement in efficiency whenever the output voltage is relatively low compared to the voltage drop across an ordinary rectifier diode.

Current Limiting

A current limit feature allows the LM3671 to protect itself and external components during overload conditions. PWM mode implements current limiting using an internal comparator that trips at 1020 mA (typ.). If the output is shorted to ground the device enters a timed current limit mode where the NFET is turned on for a longer duration until the inductor current falls below a low threshold. This allows the inductor current more time to decay, thereby preventing runaway.

PFM OPERATION

At very light load, the converter enters PFM mode and operates with reduced switching frequency and supply current to maintain high efficiency.

The part automatically transitions into PFM mode when either of two conditions occurs for a duration of 32 or more clock cycles:

- A. The NFET current reaches zero.
- B. The peak PMOS switch current drops below the I_{MODE} level, (Typically $I_{\text{MODE}} < 30\text{mA} + V_{\text{IN}}/42 \Omega$).

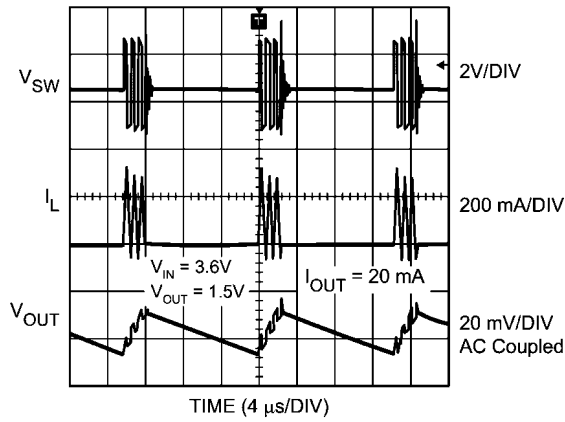

20108422

FIGURE 8. Typical PFM Operation

During PFM operation, the converter positions the output voltage slightly higher than the nominal output voltage during PWM operation, allowing additional headroom for voltage drop during a load transient from light to heavy load. The PFM comparators sense the output voltage via the feedback pin and control the switching of the output FETs such that the output voltage ramps between $\sim 0.6\%$ and $\sim 1.7\%$ above the nominal PWM output voltage. If the output voltage is below the 'high' PFM comparator threshold, the PMOS power switch

is turned on. It remains on until the output voltage reaches the 'high' PFM threshold or the peak current exceeds the I_{PFM} level set for PFM mode. The typical peak current in PFM mode is: $I_{PFM} = 112\text{mA} + V_{IN}/27\Omega$.

Once the PMOS power switch is turned off, the NMOS power switch is turned on until the inductor current ramps to zero. When the NMOS zero-current condition is detected, the NMOS power switch is turned off. If the output voltage is below the 'high' PFM comparator threshold (see Figure 9), the PMOS switch is again turned on and the cycle is repeated until the output reaches the desired level. Once the output reaches the 'high' PFM threshold, the NMOS switch is turned on briefly to ramp the inductor current to zero and then both output switches are turned off and the part enters an extremely low power mode. Quiescent supply current during this 'sleep' mode is $16\mu\text{A}$ (typ.), which allows the part to achieve high efficiency under extremely light load conditions.

If the load current should increase during PFM mode (see Figure 9) causing the output voltage to fall below the 'low2' PFM threshold, the part will automatically transition into fixed-frequency PWM mode. When $V_{IN} = 2.7\text{V}$ the part transitions from PWM to PFM mode at $\sim 35\text{mA}$ output current and from PFM to PWM mode at $\sim 85\text{mA}$, when $V_{IN} = 3.6\text{V}$, PWM to PFM transition happens at $\sim 50\text{mA}$ and PFM to PWM transition happens at $\sim 100\text{mA}$, when $V_{IN} = 4.5\text{V}$, PWM to PFM transition happens at $\sim 65\text{mA}$ and PFM to PWM transition happens at $\sim 115\text{mA}$.

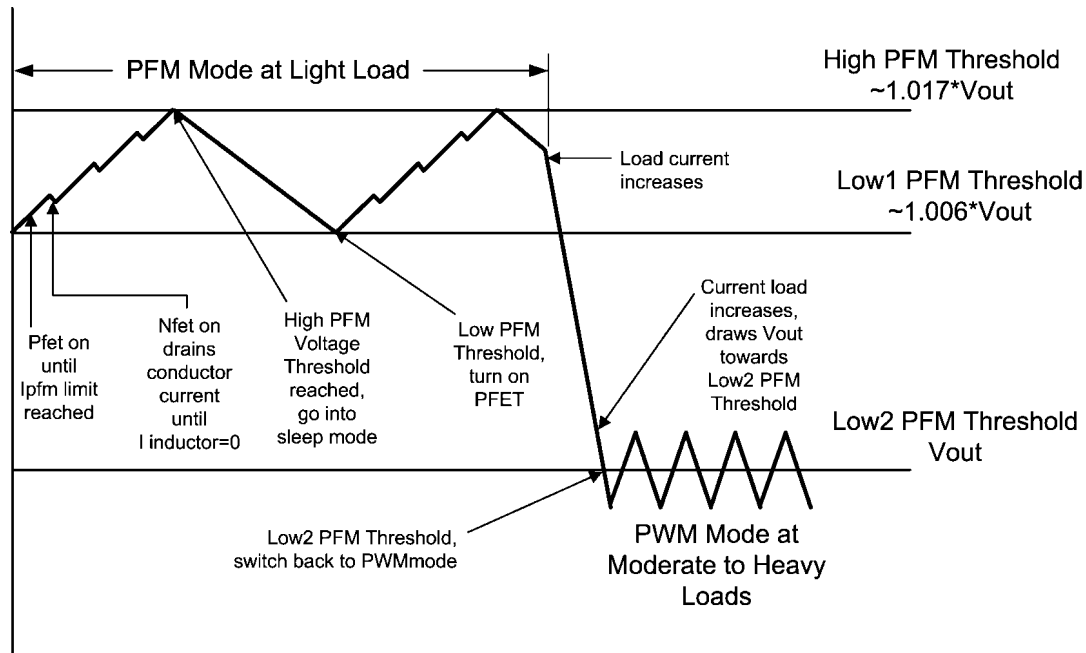

20108403

FIGURE 9. Operation in PFM Mode and Transfer to PWM Mode

SHUTDOWN MODE

Setting the EN input pin low ($< 0.4\text{V}$) places the LM3671 in shutdown mode. During shutdown the PFET switch, NFET switch, reference, control and bias circuitry of the LM3671 are turned off. Setting EN high ($> 1.0\text{V}$) enables normal operation. It is recommended to set EN pin low to turn off the LM3671 during system power up and undervoltage conditions when the supply is less than 2.7V . Do not leave the EN pin floating.

SOFT START

The LM3671 has a soft-start circuit that limits in-rush current during start-up. During start-up the switch current limit is increased in steps. Soft start is activated only if EN goes from logic low to logic high after V_{in} reaches 2.7V . Soft start is implemented by increasing switch current limit in steps of 70mA , 140mA , 280mA and 1020mA (typical switch current limit). The start-up time thereby depends on the output capacitor and

load current demanded at start-up. Typical start-up times with a 10 μ F output capacitor and 300mA load is 400 μ s and with 1mA load is 275 μ s.

LDO - LOW DROP OUT OPERATION

The LM3671-ADJ can operate at 100% duty cycle (no switching; PMOS switch completely on) for low drop out support of the output voltage. In this way the output voltage will be controlled down to the lowest possible input voltage. When the device operates near 100% duty cycle, output voltage ripple is approximately 25 mV.

The minimum input voltage needed to support the output voltage is

$$V_{IN, MIN} = I_{LOAD} * (R_{DSON, PFET} + R_{INDUCTOR}) + V_{OUT}$$

- I_{LOAD} Load current
- $R_{DSON, PFET}$ Drain to source resistance of PFET switch in the triode region
- $R_{INDUCTOR}$ Inductor resistance

Application Information

OUTPUT VOLTAGE SELECTION FOR LM3671-ADJ

The output voltage of the adjustable parts can be programmed through the resistor network connected from V_{OUT} to FB, then to GND. V_{OUT} is adjusted to make the voltage at FB equal to 0.5V. The resistor from FB to GND ($R2$) should be 200 k Ω to keep the current drawn through this network well below the 16 μ A quiescent current level (PFM mode) but large enough that it is not susceptible to noise. If $R2$ is 200 k Ω , and V_{FB} is 0.5V, the current through the resistor feedback network will be 2.5 μ A. The output voltage of the adjustable parts ranges from 1.1V to 3.3V.

The formula for output voltage selection is:

$$V_{OUT} = V_{FB} * \left(1 + \frac{R1}{R2} \right)$$

- V_{OUT} : output voltage (volts)
- V_{FB} : feedback voltage = 0.5V
- $R1$: feedback resistor from V_{OUT} to FB
- $R2$: feedback resistor from FB to GND

For any output voltage greater than or equal to 1.1V, a zero must be added around 45 kHz for stability. The formula for calculation of C1 is:

$$C1 = \frac{1}{(2 * \pi * R1 * 45 \text{ kHz})}$$

For output voltages higher than 2.5V, a pole must be placed at 45 kHz as well. If the pole and zero are at the same frequency the formula for calculation of C2 is:

$$C2 = \frac{1}{(2 * \pi * R2 * 45 \text{ kHz})}$$

The formula for location of zero and pole frequency created by adding C1 and C2 is given below. By adding C1, a zero as well as a higher frequency pole is introduced.

$$Fz = \frac{1}{(2 * \pi * R1 * C1)}$$

$$Fp = \frac{1}{2 * \pi * (R1 \parallel R2) * (C1 + C2)}$$

See the "LM3671-ADJ configurations for various V_{OUT} " table.

LM3671-ADJ Configurations For Various V_{OUT} (Circuit of Figure 2) (Refer to Note 11 for V_{IN} requirements)

$V_{OUT}(V)$	$R1(k\Omega)$	$R2(k\Omega)$	$C1(pF)$	$C2(pF)$	$L(\mu H)$	$C_{IN}(\mu F)$	$C_{OUT}(\mu F)$
0.90	160	200	22	none	2.2	4.7	10
1.1	240	200	15	none	2.2	4.7	10
1.2	280	200	12	none	2.2	4.7	10
1.3	320	200	12	none	2.2	4.7	10
1.5	357	178	10	none	2.2	4.7	10
1.6	442	200	8.2	none	2.2	4.7	10
1.7	432	178	8.2	none	2.2	4.7	10
1.8	464	178	8.2	none	2.2	4.7	10
1.875	523	191	6.8	none	2.2	4.7	10
2.5	402	100	8.2	none	2.2	4.7	10
2.8	464	100	8.2	33	2.2	4.7	10
3.3	562	100	6.8	33	2.2	4.7	10

INDUCTOR SELECTION

There are two main considerations when choosing an inductor; the inductor should not saturate, and the inductor current ripple should be small enough to achieve the desired output voltage ripple. Different saturation current rating specifications are followed by different manufacturers so attention must be given to details. Saturation current ratings are typically specified at 25°C. However, ratings at the maximum ambient temperature of application should be requested from the manufacturer. **The minimum value of inductance to guarantee good performance is 1.76μH at I_{LIM} (typ.) dc current over the ambient temperature range.** Shielded inductors radiate less noise and should be preferred.

There are two methods to choose the inductor saturation current rating.

Method 1:

The saturation current should be greater than the sum of the maximum load current and the worst case average to peak inductor current. This can be written as

$$I_{SAT} > I_{OUTMAX} + I_{RIPPLE}$$

$$\text{where } I_{RIPPLE} = \left(\frac{V_{IN} - V_{OUT}}{2 * L} \right) * \left(\frac{V_{OUT}}{V_{IN}} \right) * \left(\frac{1}{f} \right)$$

- I_{RIPPLE} : average to peak inductor current
- I_{OUTMAX} : maximum load current (600mA)
- V_{IN} : maximum input voltage in application
- L : min inductor value including worst case tolerances (30% drop can be considered for method 1)
- f : minimum switching frequency (1.6Mhz)
- V_{OUT} : output voltage

Method 2:

A more conservative and recommended approach is to choose an inductor that has a saturation current rating greater than the maximum current limit of 1150mA.

A 2.2 μH inductor with a saturation current rating of at least 1150 mA is recommended for most applications. The inductor's resistance should be less than 0.3Ω for good efficiency. *Table 1* lists suggested inductors and suppliers. For low-cost applications, an unshielded bobbin inductor could be considered. For noise critical applications, a toroidal or shielded-bobbin inductor should be used. A good practice is to lay out the board with overlapping footprints of both types for design flexibility. This allows substitution of a low-noise shielded inductor, in the event that noise from low-cost bobbin models is unacceptable.

INPUT CAPACITOR SELECTION

A ceramic input capacitor of 4.7 μF, 6.3V is sufficient for most applications. Place the input capacitor as close as possible to the V_{IN} pin of the device. A larger value may be used for improved input voltage filtering. Use X7R or X5R types; do not use Y5V. DC bias characteristics of ceramic capacitors must be considered when selecting case sizes like 0805 and 0603. **The minimum input capacitance to guarantee good performance is 2.2μF at 3V dc bias; 1.5μF at 5V dc bias including tolerances and over ambient temperature range.** The input filter capacitor supplies current to the PFET switch of the LM3671 in the first half of each cycle and reduces voltage ripple imposed on the input power source. A ceramic capacitor's low ESR provides the best noise filtering of the input voltage spikes due to this rapidly changing current. Select a capacitor with sufficient ripple current rating. The input current ripple can be calculated as:

$$I_{RMS} = I_{OUTMAX} * \sqrt{\frac{V_{OUT}}{V_{IN}} * \left(1 - \frac{V_{OUT}}{V_{IN}} + \frac{r^2}{12} \right)}$$

$$r = \frac{(V_{IN} - V_{OUT}) * V_{OUT}}{L * f * I_{OUTMAX} * V_{IN}}$$

The worst case is when $V_{IN} = 2 * V_{OUT}$

TABLE 1. Suggested Inductors and Their Suppliers

Model	Vendor	Dimensions LxWxH(mm)	D.C.R (max)
DO3314-222MX	Coilcraft	3.3 x 3.3 x 1.4	200 mΩ
LPO3310-222MX	Coilcraft	3.3 x 3.3 x 1.0	150 mΩ
ELL5GM2R2N	Panasonic	5.2 x 5.2 x 1.5	53 mΩ
CDRH2D14NP-2R2NC	Sumida	3.2 x 3.2 x 1.55	94 mΩ

OUTPUT CAPACITOR SELECTION

A ceramic output capacitor of 10 μF, 6.3V is sufficient for most applications. Use X7R or X5R types; do not use Y5V. DC bias characteristics of ceramic capacitors must be considered when selecting case sizes like 0805 and 0603. DC bias characteristics vary from manufacturer to manufacturer and dc bias curves should be requested from them as part of the capacitor selection process.

The minimum output capacitance to guarantee good performance is 5.75μF at 1.8V dc bias including tolerances and over ambient temperature range. The output filter capacitor smoothes out current flow from the inductor to the load, helps maintain a steady output voltage during transient load changes and reduces output voltage ripple. These capacitors must be selected with sufficient capacitance and sufficiently low ESR to perform these functions.

The output voltage ripple is caused by the charging and discharging of the output capacitor and by the R_{ESR} and can be calculated as:

Voltage peak-to-peak ripple due to capacitance can be expressed as follow:

$$V_{PP-C} = \frac{I_{RIPPLE}}{4 * f * C}$$

Voltage peak-to-peak ripple due to ESR can be expressed as follow:

$$V_{PP-ESR} = (2 * I_{RIPPLE}) * R_{ESR}$$

Because these two components are out of phase the rms (root mean squared) value can be used to get an approximate value of peak-to-peak ripple.

The peak-to-peak ripple voltage, rms value can be expressed as follow:

$$V_{PP-RMS} = \sqrt{V_{PP-C}^2 + V_{PP-ESR}^2}$$

Note that the output voltage ripple is dependent on the inductor current ripple and the equivalent series resistance of the output capacitor (R_{ESR}).

The R_{ESR} is frequency dependent (as well as temperature dependent); make sure the value used for calculations is at the switching frequency of the part.

TABLE 2. Suggested Capacitors and Their Suppliers

Model	Type	Vendor	Voltage Rating	Case Size Inch (mm)
4.7 μF for C_{IN}				
C2012X5R0J475K	Ceramic, X5R	TDK	6.3V	0805 (2012)
JMK212BJ475K	Ceramic, X5R	Taiyo-Yuden	6.3V	0805 (2012)
GRM21BR60J475K	Ceramic, X5R	Murata	6.3V	0805 (2012)
C1608X5R0J475K	Ceramic, X5R	TDK	6.3V	0603 (1608)
10 μF for C_{OUT}				
GRM21BR60J106K	Ceramic, X5R	Murata	6.3V	0805 (2012)
JMK212BJ106K	Ceramic, X5R	Taiyo-Yuden	6.3V	0805 (2012)
C2012X5R0J106K	Ceramic, X5R	TDK	6.3V	0805 (2012)
C1608X5R0J106K	Ceramic, X5R	TDK	6.3V	0603 (1608)

Micro SMD PACKAGE ASSEMBLY AND USE

Use of the Micro SMD package requires specialized board layout, precision mounting and careful re-flow techniques, as detailed in National Semiconductor Application Note 1112. Refer to the section "Surface Mount Technology (SMD) Assembly Considerations". For best results in assembly, alignment ordinals on the PC board should be used to facilitate placement of the device. The pad style used with Micro SMD package must be the NSMD (non-solder mask defined) type. This means that the solder-mask opening is larger than the pad size. This prevents a lip that otherwise forms if the solder-mask and pad overlap, from holding the device off the surface

of the board and interfering with mounting. See Application Note 1112 for specific instructions how to do this. The 5-Bump package used for LM3671 has 300 micron solder balls and requires 10.82 mils pads for mounting on the circuit board. The trace to each pad should enter the pad with a 90° entry angle to prevent debris from being caught in deep corners. Initially, the trace to each pad should be 7 mil wide, for a section approximately 7 mil long or longer, as a thermal relief. Then each trace should neck up or down to its optimal width. The important criteria is symmetry. This ensures the solder bumps on the LM3671 re-flow evenly and that the device solders level to the board. In particular, special attention must be paid to the pads for bumps A1 and A3, because V_{IN} and GND

are typically connected to large copper planes, inadequate thermal relief can result in late or inadequate re-flow of these bumps.

The Micro SMD package is optimized for the smallest possible size in applications with red or infrared opaque cases. Because the Micro SMD package lacks the plastic encapsulation characteristic of larger devices, it is vulnerable to light. Backside metallization and/or epoxy coating, along with front-side shading by the printed circuit board, reduce this sensitivity. However, the package has exposed die edges. In particular, Micro SMD devices are sensitive to light, in the red and infrared range, shining on the package's exposed die edges.

BOARD LAYOUT CONSIDERATIONS

PC board layout is an important part of DC-DC converter design. Poor board layout can disrupt the performance of a DC-DC converter and surrounding circuitry by contributing to EMI, ground bounce, and resistive voltage loss in the traces. These can send erroneous signals to the DC-DC converter IC, resulting in poor regulation or instability.

Good layout for the LM3671 can be implemented by following a few simple design rules below. Refer to Figure 9 for top layer board layout.

1. *Place the LM3671, inductor and filter capacitors close together and make the traces short.* The traces between these components carry relatively high switching currents and act as antennas. Following this rule reduces radiated noise. Special care must be given to place the input filter capacitor very close to the V_{IN} and GND pin.
2. *Arrange the components so that the switching current loops curl in the same direction.* During the first half of each cycle, current flows from the input filter capacitor through the LM3671 and inductor to the output filter capacitor and back through ground, forming a current loop. In the second half of each cycle, current is pulled up from ground through the LM3671 by the inductor to the output filter capacitor and then back through ground forming a second current loop. Routing these loops so the current curls in the same direction prevents magnetic

field reversal between the two half-cycles and reduces radiated noise.

3. *Connect the ground pins of the LM3671 and filter capacitors together using generous component-side copper fill as a pseudo-ground plane. Then, connect this to the ground-plane (if one is used) with several vias.* This reduces ground-plane noise by preventing the switching currents from circulating through the ground plane. It also reduces ground bounce at the LM3671 by giving it a low-impedance ground connection.
4. *Use wide traces between the power components and for power connections to the DC-DC converter circuit.* This reduces voltage errors caused by resistive losses across the traces.
5. *Route noise sensitive traces, such as the voltage feedback path, away from noisy traces between the power components.* The voltage feedback trace must remain close to the LM3671 circuit and should be direct but should be routed opposite to noisy components. This reduces EMI radiated onto the DC-DC converter's own voltage feedback trace. A good approach is to route the feedback trace on another layer and to have a ground plane between the top layer and layer on which the feedback trace is routed. In the same manner for the adjustable part it is desired to have the feedback dividers on the bottom layer.
6. *Place noise sensitive circuitry, such as radio IF blocks, away from the DC-DC converter, CMOS digital blocks and other noisy circuitry.* Interference with noise-sensitive circuitry in the system can be reduced through distance.

In mobile phones, for example, a common practice is to place the DC-DC converter on one corner of the board, arrange the CMOS digital circuitry around it (since this also generates noise), and then place sensitive preamplifiers and IF stages on the diagonally opposing corner. Often, the sensitive circuitry is shielded with a metal pan and power to it is post-regulated to reduce conducted noise, using low-dropout linear regulators.

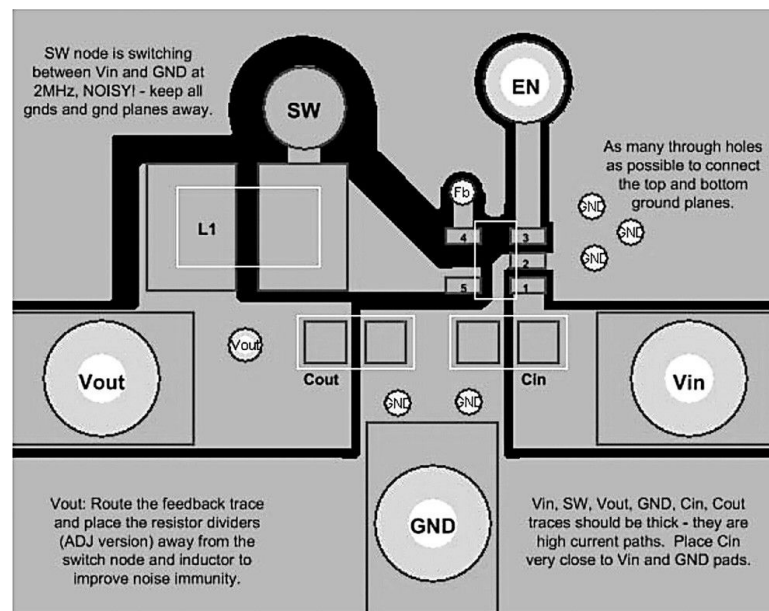

20108449

FIGURE 10. Top layer board layout for SOT23-5

Physical Dimensions inches (millimeters) unless otherwise noted

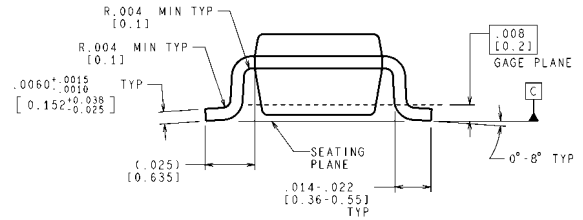
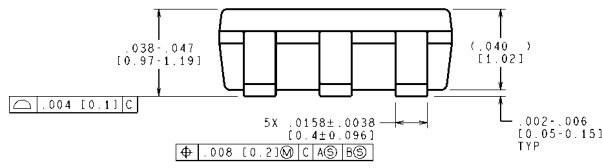
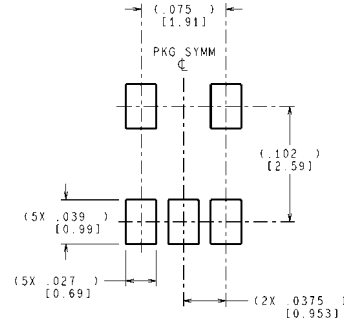
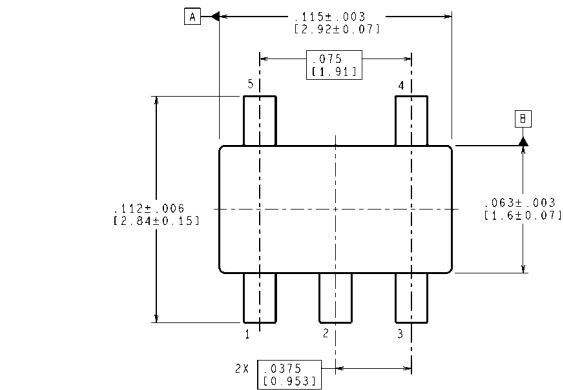

CONTROLLING DIMENSION IS INCH
VALUES IN [] ARE MILLIMETERS
DIMENSIONS IN () FOR REFERENCE ONLY

MF05A (Rev D)

5-Lead SOT23-5 Package
NS Package Number MF05A

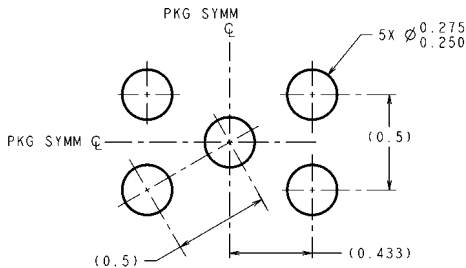

DIMENSIONS ARE IN MILLIMETERS
DIMENSIONS IN () FOR REFERENCE ONLY

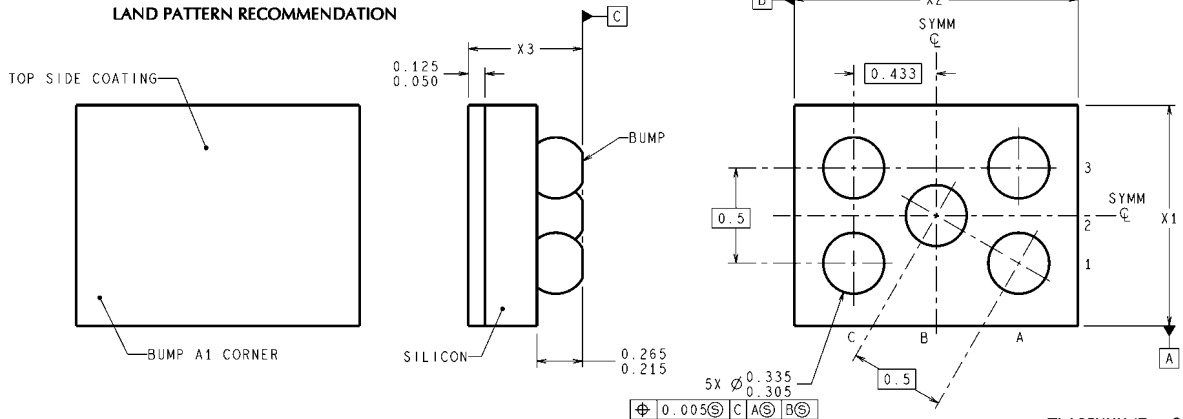

5-Bump (Large) Micro SMD Package, 0.5mm Pitch
NS Package Number TLA05CBA

The dimensions for X1, X2, and X3 are as given:

X1 = 1.057 mm +/- 0.030mm

X2 = 1.387 mm +/- 0.030mm

X3 = 0.600 mm +/- 0.075mm

TLA05XXX (Rev C)

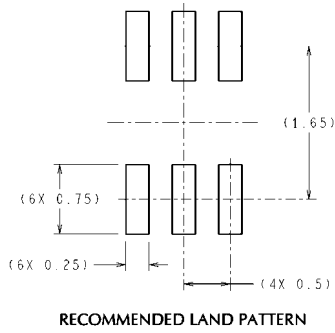

DIMENSIONS ARE IN MILLIMETERS
DIMENSION IN () FOR REFERENCE ONLY

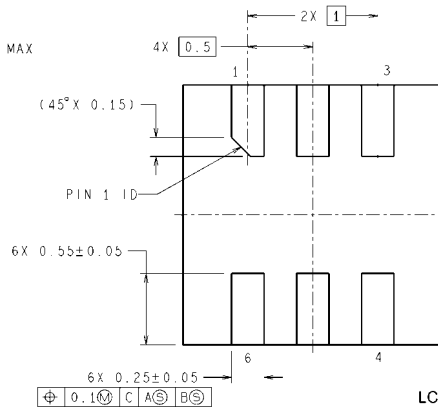
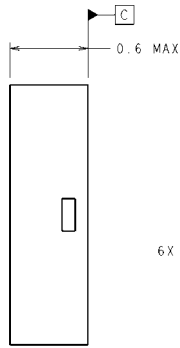
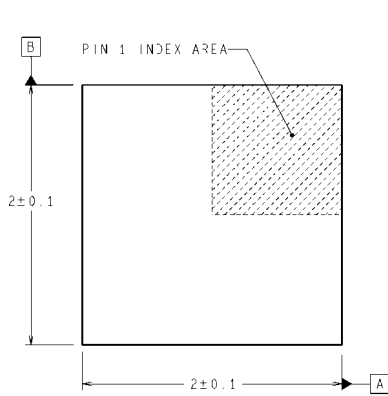
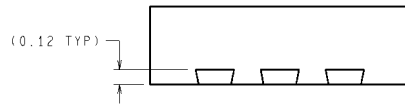

LCA06B (Rev A)

6-Pin LLP Package, 0.5mm Pitch
NS Package Number LCA06B
The dimensions for X1, X2, and X3 are as given:
X1 = 2.000 mm +/- 0.100mm
X2 = 2.000 mm +/- 0.100mm
X3 = 0.600 mm +/- 0.075mm

Notes

For more National Semiconductor product information and proven design tools, visit the following Web sites at:

Products		Design Support	
Amplifiers	www.national.com/amplifiers	WEBENCH	www.national.com/webench
Audio	www.national.com/audio	Analog University	www.national.com/AU
Clock Conditioners	www.national.com/timing	App Notes	www.national.com/appnotes
Data Converters	www.national.com/adc	Distributors	www.national.com/contacts
Displays	www.national.com/displays	Green Compliance	www.national.com/quality/green
Ethernet	www.national.com/ethernet	Packaging	www.national.com/packaging
Interface	www.national.com/interface	Quality and Reliability	www.national.com/quality
LVDS	www.national.com/lvds	Reference Designs	www.national.com/refdesigns
Power Management	www.national.com/power	Feedback	www.national.com/feedback
Switching Regulators	www.national.com/switchers		
LDOs	www.national.com/lido		
LED Lighting	www.national.com/led		
PowerWise	www.national.com/powerwise		
Serial Digital Interface (SDI)	www.national.com/sdi		
Temperature Sensors	www.national.com/tempsensors		
Wireless (PLL/VCO)	www.national.com/wireless		

THE CONTENTS OF THIS DOCUMENT ARE PROVIDED IN CONNECTION WITH NATIONAL SEMICONDUCTOR CORPORATION ("NATIONAL") PRODUCTS. NATIONAL MAKES NO REPRESENTATIONS OR WARRANTIES WITH RESPECT TO THE ACCURACY OR COMPLETENESS OF THE CONTENTS OF THIS PUBLICATION AND RESERVES THE RIGHT TO MAKE CHANGES TO SPECIFICATIONS AND PRODUCT DESCRIPTIONS AT ANY TIME WITHOUT NOTICE. NO LICENSE, WHETHER EXPRESS, IMPLIED, ARISING BY ESTOPPEL OR OTHERWISE, TO ANY INTELLECTUAL PROPERTY RIGHTS IS GRANTED BY THIS DOCUMENT.

TESTING AND OTHER QUALITY CONTROLS ARE USED TO THE EXTENT NATIONAL DEEMS NECESSARY TO SUPPORT NATIONAL'S PRODUCT WARRANTY. EXCEPT WHERE MANDATED BY GOVERNMENT REQUIREMENTS, TESTING OF ALL PARAMETERS OF EACH PRODUCT IS NOT NECESSARILY PERFORMED. NATIONAL ASSUMES NO LIABILITY FOR APPLICATIONS ASSISTANCE OR BUYER PRODUCT DESIGN. BUYERS ARE RESPONSIBLE FOR THEIR PRODUCTS AND APPLICATIONS USING NATIONAL COMPONENTS. PRIOR TO USING OR DISTRIBUTING ANY PRODUCTS THAT INCLUDE NATIONAL COMPONENTS, BUYERS SHOULD PROVIDE ADEQUATE DESIGN, TESTING AND OPERATING SAFEGUARDS.

EXCEPT AS PROVIDED IN NATIONAL'S TERMS AND CONDITIONS OF SALE FOR SUCH PRODUCTS, NATIONAL ASSUMES NO LIABILITY WHATSOEVER, AND NATIONAL DISCLAIMS ANY EXPRESS OR IMPLIED WARRANTY RELATING TO THE SALE AND/OR USE OF NATIONAL PRODUCTS INCLUDING LIABILITY OR WARRANTIES RELATING TO FITNESS FOR A PARTICULAR PURPOSE, MERCHANTABILITY, OR INFRINGEMENT OF ANY PATENT, COPYRIGHT OR OTHER INTELLECTUAL PROPERTY RIGHT.

LIFE SUPPORT POLICY

NATIONAL'S PRODUCTS ARE NOT AUTHORIZED FOR USE AS CRITICAL COMPONENTS IN LIFE SUPPORT DEVICES OR SYSTEMS WITHOUT THE EXPRESS PRIOR WRITTEN APPROVAL OF THE CHIEF EXECUTIVE OFFICER AND GENERAL COUNSEL OF NATIONAL SEMICONDUCTOR CORPORATION. As used herein:

Life support devices or systems are devices which (a) are intended for surgical implant into the body, or (b) support or sustain life and whose failure to perform when properly used in accordance with instructions for use provided in the labeling can be reasonably expected to result in a significant injury to the user. A critical component is any component in a life support device or system whose failure to perform can be reasonably expected to cause the failure of the life support device or system or to affect its safety or effectiveness.

National Semiconductor and the National Semiconductor logo are registered trademarks of National Semiconductor Corporation. All other brand or product names may be trademarks or registered trademarks of their respective holders.

Copyright© 2008 National Semiconductor Corporation

For the most current product information visit us at www.national.com



National Semiconductor Americas Technical Support Center
Email: support@nsc.com
Tel: 1-800-272-9959

National Semiconductor Europe Technical Support Center
Email: europe.support@nsc.com
German Tel: +49 (0) 180 5010 771
English Tel: +44 (0) 870 850 4288

National Semiconductor Asia Pacific Technical Support Center
Email: ap.support@nsc.com

National Semiconductor Japan Technical Support Center
Email: jpn.feedback@nsc.com