

REVISIONS			
LTR	DESCRIPTION	DATE (YR-MO-DA)	APPROVED
P	Add case outline M. Technical changes and corrections to table I. Editorial changes throughout.	93-10-02	M. A. FRYE
R	Add class V level devices. Update boilerplate. - ro	99-06-08	R. MONNIN
T	Add case outline N. Make changes to 1.2.4, P _D , theta JC, I _{MAX} as specified in 1.3, table I, and figure 1. - ro	99-09-23	R. MONNIN
U	Add radiation hardened requirements to device types 02 and 07 for case outline U. Add terminal assignment table for case outline N as specified in figure 1. Add case outline 4 for device type 07. - ro	00-10-11	R. MONNIN
V	Add case outlines 5 and 6. Make changes to 1.2.4, P _D , theta JC, I _{MAX} as specified in 1.3, table I, and figure 1. Update boilerplate to reflect current requirements. - rrp	03-12-10	R. MONNIN
W	Add a footnote to the case outline U, TO-257 package as specified under 1.2.4 and figure 1. - ro	05-02-07	R. MONNIN
X	For case outline "T" only, add a footnote 1/ under 1.2.4 and make change to note 3 under figure 1. For device types 02, 04, 07, and 08 add pin outs under case outline 2 in figure 1. -rrp	06-01-30	R. MONNIN

THE ORIGINAL FIRST SHEET OF THIS DRAWING HAS BEEN REPLACED.

REV	X	X	X	X	X	X	X	X	X	X	X									
SHEET	35	36	37	38	39	40	41	42	43	44	45									
REV	X	X	X	X	X	X	X	X	X	X	X	X	X	X	X	X	X	X	X	X
SHEET	15	16	17	18	19	20	21	22	23	24	25	26	27	28	29	30	31	32	33	34
REV STATUS OF SHEETS				REV			X	X	X	X	X	X	X	X	X	X	X	X	X	X
				SHEET			1	2	3	4	5	6	7	8	9	10	11	12	13	14

PMIC N/A	PREPARED BY WILLIAM E. SHOUP		DEFENSE SUPPLY CENTER COLUMBUS COLUMBUS, OHIO 43218-3990 http://www.dsc.dla.mil																	
STANDARD MICROCIRCUIT DRAWING	CHECKED BY C.R. JACKSON																			
THIS DRAWING IS AVAILABLE FOR USE BY ALL DEPARTMENTS AND AGENCIES OF THE DEPARTMENT OF DEFENSE	APPROVED BY N. A. HAUCK		MICROCIRCUIT, LINEAR, ADJUSTABLE VOLTAGE REGULATOR, MONOLITHIC SILICON																	
	DRAWING APPROVAL DATE 77-09-15																			
	AMSC N/A	REVISION LEVEL X																		
		SHEET 1 OF 45																		

1. SCOPE

1.1 Scope. This drawing documents two product assurance class levels consisting of high reliability (device classes Q and M) and space application (device class V). A choice of case outlines and lead finishes are available and are reflected in the Part or Identifying Number (PIN). When available, a choice of Radiation Hardness Assurance (RHA) levels are reflected in the PIN.

1.2 PIN. The PIN is as shown in the following examples.

For device classes M and Q:

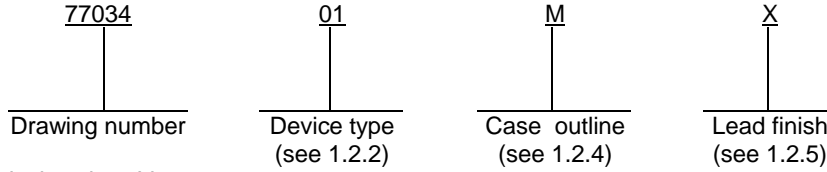

For device class V:

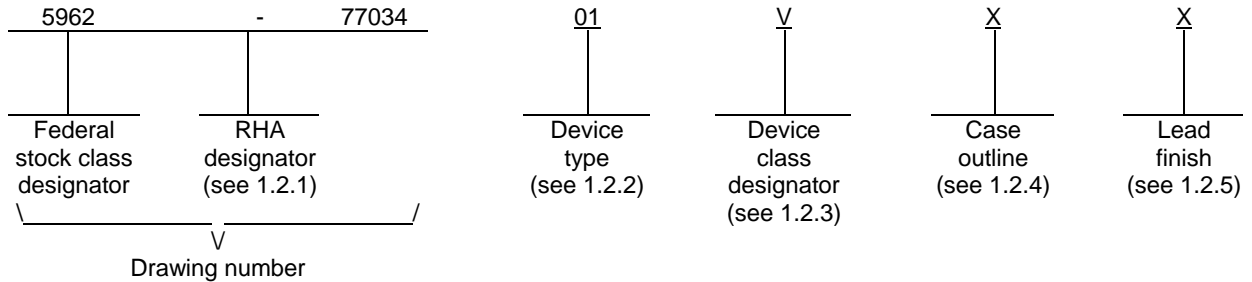

For device classes M, Q, and V radiation hardened devices:

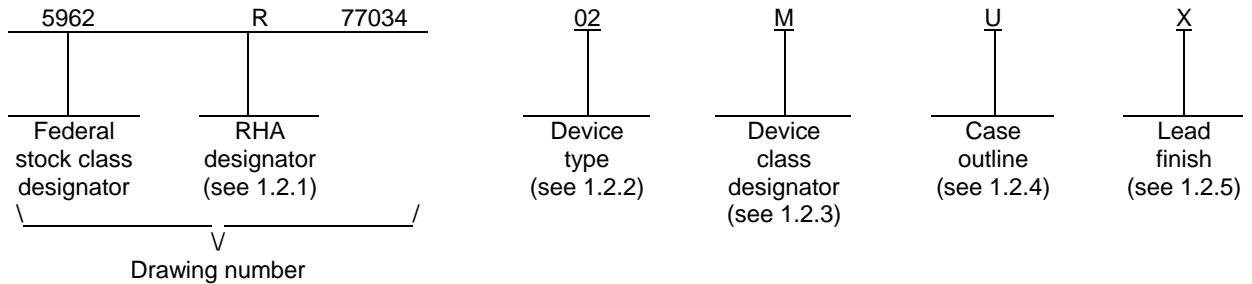

1.2.1 RHA designator. Device classes Q and V RHA marked devices meet the MIL-PRF-38535 specified RHA levels and are marked with the appropriate RHA designator. Device class M RHA marked devices meet the MIL-PRF-38535, appendix A specified RHA levels and are marked with the appropriate RHA designator. A dash (-) indicates a non-RHA device.

1.2.2 Device type(s). The device type(s) identify the circuit function as follows:

Device type	Generic number	Circuit function
01	LM117	Positive adjustable voltage regulator
02	LM117HV	Positive adjustable voltage regulator, high voltage
03	LM137	Negative adjustable voltage regulator
04	LM137HV	Negative adjustable voltage regulator, high voltage
05	LT117A	Positive adjustable voltage regulator
06	LT137A	Negative adjustable voltage regulator
07	LT117AHV	Positive adjustable voltage regulator, high voltage
08	LT137AHV	Negative adjustable voltage regulator, high voltage

STANDARD MICROCIRCUIT DRAWING DEFENSE SUPPLY CENTER COLUMBUS COLUMBUS, OHIO 43218-3990	SIZE A		77034
		REVISION LEVEL X	SHEET 2

1.2.3 Device class designator. The device class designator is a single letter identifying the product assurance level as listed below. Since the device class designator has been added after the original issuance of this drawing, device classes M and Q designators will not be included in the PIN and will not be marked on the device except for those devices that use a RHA designator

<u>Device class</u>	<u>Device requirements documentation</u>
M	Vendor self-certification to the requirements for MIL-STD-883 compliant, non-JAN class level B microcircuits in accordance with MIL-PRF-38535, appendix A
Q or V	Certification and qualification to MIL-PRF-38535

1.2.4 Case outline(s). The case outline(s) are as designated in MIL-STD-1835 and as follows:

<u>Outline letter</u>	<u>Descriptive designator</u>	<u>Terminals</u>	<u>Package style</u>
M	See figure 1	3	Power surface mount
N	See figure 1	3	Surface mount
T ^{1/}	See figure 1	3	TO-257 flange mount, glass sealed
U ^{1/}	See figure 1	3	TO-257 flange mount with isolated tab, glass sealed
X	See figure 1	3	TO-39 can
Y	MBFM1-P2	2	Flange mount
Z	MBFM4-P2	2	Flange mount
2	CQCC1-N20	20	Square leadless chip carrier
4	See figure 1	3	SMD-257-A flange mount, glass sealed
5	See figure 1	18	Rectangular leadless chip carrier
6	See figure 1	18	Rectangular leadless chip carrier

1.2.5 Lead finish. The lead finish is as specified in MIL-PRF-38535 for device classes Q and V or MIL-PRF-38535, appendix A for device class M.

1.3 Absolute maximum ratings. ^{2/}

Power dissipation (P_D):

Case X 2 W
 Cases M, N, T, U, Y, Z and 4 (internally limited) 20 W

Case 2:

At T_A = +25°C 1.1 W
 At T_C = +25°C 6.2 W
 Cases 5 and 6 at T_C = +25°C 10 W

Input-output voltage differential:

Device types 01, 03, 05, 06 40 V dc
 Device types 02, 07 60 V dc
 Device types 04, 08 50 V dc

Operating junction temperature range -55°C to +150°C

Storage temperature -65°C to +150°C

Lead temperature (soldering, 10 seconds) 300°C

Thermal resistance, junction to case (θ_{JC}):

Cases M, N, and T 3.5°C/W
 Cases U and 4 4.2°C/W
 Case X 15°C/W
 Case Y 3°C/W
 Case Z 5°C/W
 Case 2 See MIL-STD-1835
 Cases 5 and 6 13°C/W

^{1/} For outline letters T and U, CAGE 34333 manufacturers the TO-257 package with ceramic seal.

^{2/} Stresses above the absolute maximum rating may cause permanent damage to the device. Extended operation at the maximum levels may degrade performance and affect reliability.

STANDARD MICROCIRCUIT DRAWING DEFENSE SUPPLY CENTER COLUMBUS COLUMBUS, OHIO 43218-3990	SIZE A		77034
		REVISION LEVEL X	SHEET 3

1.3 Absolute maximum ratings – Continued. 2/

Maximum output current (I_{MAX}):

Cases X, 2, 5, and 6	0.5 A
Cases M, N, T, U, Y, Z, and 4	1.5 A

1.4 Recommended operating conditions.

Output voltage range:

Device types 01, 05	1.2 to 37 V dc
Device types 02, 07	1.2 to 57 V dc
Device types 03, 06	-1.2 to -37 V dc
Device types 04, 08	-1.2 to -47 V dc

Ambient operating temperature range (T_A) -55°C to +125°C

Input voltage range:

Device types 01, 05	4.25 V dc to 41.25 V dc
Device types 03, 06	-4.25 V dc to -41.25 V dc
Device types 02, 07	4.25 V dc to 61.25 V dc
Device types 04, 08	-4.25 V dc to -51.25 V dc

1.5 Radiation features.

Maximum total dose available (dose rate = 50 – 300 rads(Si)/s): 3/

Device types 02 and 07	100 Krads(Si)
------------------------------	---------------

2. APPLICABLE DOCUMENTS

2.1 Government specification, standards, and handbooks. The following specification, standards, and handbooks form a part of this drawing to the extent specified herein. Unless otherwise specified, the issues of these documents are those cited in the solicitation or contract.

DEPARTMENT OF DEFENSE SPECIFICATION

MIL-PRF-38535 - Integrated Circuits, Manufacturing, General Specification for.

DEPARTMENT OF DEFENSE STANDARDS

MIL-STD-883 - Test Method Standard Microcircuits.
 MIL-STD-1835 - Interface Standard Electronic Component Case Outlines.

DEPARTMENT OF DEFENSE HANDBOOKS

MIL-HDBK-103 - List of Standard Microcircuit Drawings.
 MIL-HDBK-780 - Standard Microcircuit Drawings.

(Copies of these documents are available online at <http://assist.daps.dla.mil/quicksearch/> or <http://assist.daps.dla.mil> or from the Standardization Document Order Desk, 700 Robbins Avenue, Building 4D, Philadelphia, PA 19111-5094.)

3/ These parts may be dose rate sensitive in a space environment and may demonstrate enhanced low dose rate effects. Radiation end point limits for the noted parameters are guaranteed only for the conditions specified in MIL-STD-883, method 1019, condition A.

STANDARD MICROCIRCUIT DRAWING DEFENSE SUPPLY CENTER COLUMBUS COLUMBUS, OHIO 43218-3990	SIZE A		77034
		REVISION LEVEL X	SHEET 4

2.2 Order of precedence. In the event of a conflict between the text of this drawing and the references cited herein, the text of this drawing takes precedence. Nothing in this document, however, supersedes applicable laws and regulations unless a specific exemption has been obtained.

3. REQUIREMENTS

3.1 Item requirements. The individual item requirements for device classes Q and V shall be in accordance with MIL-PRF-38535 and as specified herein or as modified in the device manufacturer's Quality Management (QM) plan. The modification in the QM plan shall not affect the form, fit, or function as described herein. The individual item requirements for device class M shall be in accordance with MIL-PRF-38535, appendix A for non-JAN class level B devices and as specified herein.

3.2 Design, construction, and physical dimensions. The design, construction, and physical dimensions shall be as specified in MIL-PRF-38535 and herein for device classes Q and V or MIL-PRF-38535, appendix A and herein for device class M.

3.2.1 Case outlines. The case outlines shall be in accordance with 1.2.4 herein and figure 1.

3.2.2 Terminal connections. The terminal connections shall be as specified on figure 1.

3.2.3 Radiation exposure circuit. The radiation exposure circuit shall be maintained by the manufacturer under document revision level control and shall be made available to the preparing and acquiring activity upon request.

3.3 Electrical performance characteristics and postirradiation parameter limits. Unless otherwise specified herein, the electrical performance characteristics and postirradiation parameter limits are as specified in table I and shall apply over the full ambient operating temperature range.

3.4 Electrical test requirements. The electrical test requirements shall be the subgroups specified in table IIA. The electrical tests for each subgroup are defined in table I.

3.5 Marking. The part shall be marked with the PIN listed in 1.2 herein. In addition, the manufacturer's PIN may also be marked. For packages where marking of the entire SMD PIN number is not feasible due to space limitations, the manufacturer has the option of not marking the "5962-" on the device. For RHA product using this option, the RHA designator shall still be marked. Marking for device classes Q and V shall be in accordance with MIL-PRF-38535. Marking for device class M shall be in accordance with MIL-PRF-38535, appendix A.

3.5.1 Certification/compliance mark. The certification mark for device classes Q and V shall be a "QML" or "Q" as required in MIL-PRF-38535. The compliance mark for device class M shall be a "C" as required in MIL-PRF-38535, appendix A.

3.6 Certificate of compliance. For device classes Q and V, a certificate of compliance shall be required from a QML-38535 listed manufacturer in order to supply to the requirements of this drawing (see 6.6.1 herein). For device class M, a certificate of compliance shall be required from a manufacturer in order to be listed as an approved source of supply in MIL-HDBK-103 (see 6.6.2 herein). The certificate of compliance submitted to DSCC-VA prior to listing as an approved source of supply for this drawing shall affirm that the manufacturer's product meets, for device classes Q and V, the requirements of MIL-PRF-38535 and herein or for device class M, the requirements of MIL-PRF-38535, appendix A and herein.

3.7 Certificate of conformance. A certificate of conformance as required for device classes Q and V in MIL-PRF-38535 or for device class M in MIL-PRF-38535, appendix A shall be provided with each lot of microcircuits delivered to this drawing.

3.8 Notification of change for device class M. For device class M, notification to DSCC-VA of change of product (see 6.2 herein) involving devices acquired to this drawing is required for any change that affects this drawing.

3.9 Verification and review for device class M. For device class M, DSCC, DSCC's agent, and the acquiring activity retain the option to review the manufacturer's facility and applicable required documentation. Offshore documentation shall be made available onshore at the option of the reviewer.

3.10 Microcircuit group assignment for device class M. Device class M devices covered by this drawing shall be in microcircuit group number 52 (see MIL-PRF-38535, appendix A).

STANDARD MICROCIRCUIT DRAWING DEFENSE SUPPLY CENTER COLUMBUS COLUMBUS, OHIO 43218-3990	SIZE A		77034
		REVISION LEVEL X	SHEET 5

TABLE I. Electrical performance characteristics.

Test	Symbol	Conditions -55°C ≤ T _A ≤ +125°C I _L = 8 mA unless otherwise specified	Group A subgroups	Device type	Limits		Unit
					Min	Max	
Cases X, 2, 5 and 6							
Reference voltage	V _{REF}	V _{DIFF} = 3.0 V	1	01	1.20	1.30	V
		V _{DIFF} = 3.3 V	2,3		1.20	1.30	
		V _{DIFF} = 40 V	1,2,3		1.20	1.30	
Line regulation	R _{LINE}	3.0 ≤ V _{DIFF} ≤ 40 V, V _{OUT} = V _{REF}	1	01		±9	mV
		3.3 ≤ V _{DIFF} ≤ 40 V, V _{OUT} = V _{REF}	2,3			±23	
Load regulation 1/	R _{LOAD}	V _{DIFF} = 3 V, 10 mA ≤ I _L ≤ 500 mA	1	01		±15	mV
		V _{DIFF} = 3.3 V, 10 mA ≤ I _L ≤ 500 mA	2,3			±15	
		V _{DIFF} = 40V, 10 mA ≤ I _L ≤ 150 mA	1			±15	
		V _{DIFF} = 40 V, 10 mA ≤ I _L ≤ 100 mA	2,3			±15	
Thermal regulation	V _{RTH}	V _{IN} = +14.6 V, I _L = 300 mA, t = 20 ms, P _D = 4 W, T _A = +25°C	1	01		±3.1	mV
Ripple rejection	R _N	f = 120 Hz, C _{ADJ} = 10 μF, V _{OUT} = V _{REF} 2/	4,5,6	01	66		dB
Adjustment pin current	I _{ADJ}	V _{DIFF} = 3.0 V	1	01		100	μA
		V _{DIFF} = 3.3 V	2,3			100	
		V _{DIFF} = 40 V	1,2,3			100	
Adjustment pin current change	ΔI _{ADJ}	V _{DIFF} = 3 V, 10 mA ≤ I _L ≤ 500 mA	1	01		±5	μA
		V _{DIFF} = 3.3 V, 10 mA ≤ I _L ≤ 500 mA	2,3			±5	
		V _{DIFF} = 40 V, 10 mA ≤ I _L ≤ 150 mA	1			±5	
		V _{DIFF} = 40 V, 10 mA ≤ I _L ≤ 100 mA	2,3			±5	

See footnotes at end of table.

STANDARD MICROCIRCUIT DRAWING DEFENSE SUPPLY CENTER COLUMBUS COLUMBUS, OHIO 43218-3990	SIZE A		77034
		REVISION LEVEL X	SHEET 6

TABLE I. Electrical performance characteristics - Continued.

Test	Symbol	Conditions -55°C ≤ T _A ≤ +125°C I _L = 8 mA unless otherwise specified	Group A subgroups	Device type	Limits		Unit
					Min	Max	
Cases X, 2, 5 and 6 - Continued.							
Adjustment pin current change	ΔI _{ADJ}	3 V ≤ V _{DIFF} ≤ 40 V	1	01		±5	μA
		3.3 V ≤ V _{DIFF} ≤ 40 V	2,3			±5	
Minimum load current	I _{LMIN}	V _{DIFF} = 3.0 V, V _{OUT} = 1.4 V (forced)	1	01		5	mA
		V _{DIFF} = 3.3 V, V _{OUT} = 1.4 V (forced)	2,3			5	
		V _{DIFF} = 40 V, V _{OUT} = 1.4 V (forced)	1,2,3			5	
Current limit <u>2</u> /	I _{CL}	V _{DIFF} = 15 V	1,2,3	01	0.5	1.65	A
		V _{DIFF} = 40 V	1		0.15	0.65	
Cases M, N, T, U, Y, Z							
Reference voltage	V _{REF}	V _{DIFF} = 3.0 V	1	01	1.20	1.30	V
		V _{DIFF} = 3.3 V	2,3		1.20	1.30	
		V _{DIFF} = 40 V	1,2,3		1.20	1.30	
Line regulation	R _{LINE}	V _{OUT} = V _{REF} , 3.0 V ≤ V _{DIFF} ≤ 40 V	1	01		±9	mV
		V _{OUT} = V _{REF} , 3.3 V ≤ V _{DIFF} ≤ 40 V	2,3			±23	
Load regulation <u>1</u> /	R _{LOAD}	V _{DIFF} = 3 V, 10 mA ≤ I _L ≤ 1.5 A	1	01		±15	mV
		V _{DIFF} = 3.3 V, 10 mA ≤ I _L ≤ 1.5 A	2,3			±15	
		V _{DIFF} = 40V, 10 mA ≤ I _L ≤ 300 mA	1			±15	
		V _{DIFF} = 40 V, 10 mA ≤ I _L ≤ 195 mA	2,3			±15	
Thermal regulation	V _{RTH}	V _{IN} = 14.6 V, I _L = 1.5 A, P _D = 20 watts, t = 20 ms, T _A = +25°C	1	01		±16	mV

See footnotes at end of table.

STANDARD MICROCIRCUIT DRAWING DEFENSE SUPPLY CENTER COLUMBUS COLUMBUS, OHIO 43218-3990	SIZE A		77034
		REVISION LEVEL X	SHEET 7

TABLE I. Electrical performance characteristics - Continued.

Test	Symbol	Conditions -55°C ≤ T _A ≤ +125°C I _L = 8 mA unless otherwise specified	Group A subgroups	Device type	Limits		Unit
					Min	Max	
Cases M, N, T, U, Y, Z - Continued.							
Ripple rejection	R _N	f = 120 Hz, C _{ADJ} = 10 μF, V _{OUT} = V _{REF} <u>2</u> /	4,5,6	01	66		dB
Adjustment pin current	I _{ADJ}	V _{DIFF} = 3.0 V	1	01		100	μA
		V _{DIFF} = 3.3 V	2,3			100	
		V _{DIFF} = 40 V	1,2,3			100	
Adjustment pin current change	ΔI _{ADJ}	V _{DIFF} = 3 V, 10 mA ≤ I _L ≤ 1.5 A	1	01		±5	μA
		V _{DIFF} = 3.3 V, 10 mA ≤ I _L ≤ 1.5 A	2,3			±5	
		V _{DIFF} = 40 V, 10 mA ≤ I _L ≤ 300 mA	1			±5	
		V _{DIFF} = 40 V, 10 mA ≤ I _L ≤ 195 mA	2,3			±5	
		3 V ≤ V _{DIFF} ≤ 40 V	1			±5	
		3.3 V ≤ V _{DIFF} ≤ 40 V	2,3			±5	
Minimum load current	I _{LMIN}	V _{DIFF} = 3.0 V, V _{OUT} = 1.4 V (forced)	1	01		5	mA
		V _{DIFF} = 3.3 V, V _{OUT} = 1.4 V (forced)	2,3			5	
		V _{DIFF} = 40 V, V _{OUT} = 1.4 V (forced)	1,2,3			5	
Current limit <u>2</u> /	I _{CL}	V _{DIFF} = 15 V	1,2,3	01	1.50	3.50	A
		V _{DIFF} = 40 V	1		0.18	1.5	

Cases X, 2, 5, and 6

Reference voltage	V _{REF}	V _{DIFF} = 3.0 V	1	02	1.20	1.30	V
		V _{DIFF} = 3.3 V	2,3		1.20	1.30	
		V _{DIFF} = 40 V	1,2,3		1.20	1.30	
		V _{DIFF} = 60 V	1,2,3		1.20	1.30	

See footnotes at end of table.

STANDARD MICROCIRCUIT DRAWING DEFENSE SUPPLY CENTER COLUMBUS COLUMBUS, OHIO 43218-3990	SIZE A		77034
		REVISION LEVEL X	SHEET 8

TABLE I. Electrical performance characteristics - Continued.

Test	Symbol	Conditions -55°C ≤ T _A ≤ +125°C I _L = 8 mA unless otherwise specified	Group A subgroups	Device type	Limits		Unit
					Min	Max	
Cases X, 2, 5, and 6 - Continued.							
Line regulation <u>3/</u>	R _{LINE}	V _{OUT} = V _{REF} , 3.0 V ≤ V _{DIFF} ≤ 40 V	1	02		±9	mV
		V _{OUT} = V _{REF} , 3.3 V ≤ V _{DIFF} ≤ 40 V	2,3			±23	
		V _{OUT} = V _{REF} , 40 V ≤ V _{DIFF} ≤ 60 V	1			±5	
			2,3			±10	
Load regulation <u>1/</u>	R _{LOAD}	V _{DIFF} = 3 V, 10 mA ≤ I _L ≤ 500 mA	1	02		±15	mV
		V _{DIFF} = 3.3 V, 10 mA ≤ I _L ≤ 500 mA	2,3			±15	
		V _{DIFF} = 40V, 10 mA ≤ I _L ≤ 150 mA	1			±15	
		V _{DIFF} = 40 V, 10 mA ≤ I _L ≤ 100 mA	2,3			±15	
		V _{DIFF} = 60 V, 10 mA ≤ I _L ≤ 20 mA	1,2,3			±15	
Thermal regulation	V _{RTH}	V _{IN} = 14.6 V, I _L = 300 mA, t = 20 ms, P _D = 4 W, T _A = +25°C	1	02		±3.1	mV
Ripple rejection <u>2/</u>	R _N	f = 120 Hz, C _{ADJ} = 10 μF, V _{OUT} = V _{REF} , I _{OUT} = 100 mA	4,5,6	02	66		dB
Adjustment pin current	I _{ADJ}	V _{DIFF} = 3.0 V	1	02		100	μA
		V _{DIFF} = 3.3 V	2,3			100	
		V _{DIFF} = 40 V	1,2,3			100	
		V _{DIFF} = 60 V	1,2,3			100	

See footnotes at end of table.

STANDARD MICROCIRCUIT DRAWING DEFENSE SUPPLY CENTER COLUMBUS COLUMBUS, OHIO 43218-3990	SIZE A		77034
		REVISION LEVEL X	SHEET 9

TABLE I. Electrical performance characteristics - Continued.

Test	Symbol	Conditions -55°C ≤ T _A ≤ +125°C I _L = 8 mA unless otherwise specified	Group A subgroups	Device type	Limits		Unit
					Min	Max	
Case X, 2, 5, and 6 - Continued.							
Adjustment pin current change	ΔI _{ADJ}	V _{DIFF} = 3 V, 10 mA ≤ I _L ≤ 500 mA	1	02		±5	μA
		V _{DIFF} = 3.3 V, 10 mA ≤ I _L ≤ 500 mA	2,3			±5	
		V _{DIFF} = 40 V, 10 mA ≤ I _L ≤ 150 mA	1			±5	
		V _{DIFF} = 40 V, 10 mA ≤ I _L ≤ 100 mA	2,3			±5	
		3 V ≤ V _{DIFF} ≤ 40 V	1			±5	
		3.3 V ≤ V _{DIFF} ≤ 40 V	2,3			±5	
		3.3 V ≤ V _{DIFF} ≤ 60 V	1,2,3			±5	
Minimum load current	I _{LMIN}	V _{DIFF} = 3.0 V, V _{OUT} = 1.4 V (forced)	1	02		5	mA
		V _{DIFF} = 3.3 V, V _{OUT} = 1.4 V (forced)	2,3			5	
		V _{DIFF} = 40 V, V _{OUT} = 1.4 V (forced)	1,2,3			5	
		V _{DIFF} = 60 V, V _{OUT} = 1.4 V (forced)	1,2,3			7	
Current limit <u>2/</u>	I _{CL}	V _{DIFF} = 5 V	1,2,3	02	0.5	1.65	A
		V _{DIFF} = 40 V	1		0.15	0.65	
		V _{DIFF} = 60 V	1		0.02	0.28	

Cases M, N, T, U, Y, Z 4/ 5/

Reference voltage	V _{REF}	V _{DIFF} = 3.0 V	1	02	1.20	1.30	V
		M,D,P,L,R	1		1.20	1.30	
		V _{DIFF} = 3.3 V	2,3		1.20	1.30	
		V _{DIFF} = 40 V	1,2,3		1.20	1.30	
		M,D,P,L,R	1		1.20	1.30	
		V _{DIFF} = 60 V	1,2,3		1.20	1.30	
		M,D,P,L,R	1		1.20	1.30	

See footnotes at end of table.

STANDARD MICROCIRCUIT DRAWING DEFENSE SUPPLY CENTER COLUMBUS COLUMBUS, OHIO 43218-3990	SIZE A		77034
		REVISION LEVEL X	SHEET 10

TABLE I. Electrical performance characteristics - Continued.

Test	Symbol	Conditions -55°C ≤ T _A ≤ +125°C I _L = 8 mA unless otherwise specified	Group A subgroups	Device type	Limits		Unit
					Min	Max	
Cases M, N, T, U, Y, Z - Continued. <u>4/ 5/</u>							
Line regulation <u>3/</u>	R _{LINE}	V _{OUT} = V _{REF} , 3.0 V ≤ V _{DIFF} ≤ 40 V	1	02		±9	mV
		M,D,P,L,R	1			±9	
		V _{OUT} = V _{REF} , 3.3 V ≤ V _{DIFF} ≤ 40 V	2,3			±23	
		V _{OUT} = V _{REF} , 40 V ≤ V _{DIFF} ≤ 60 V	1			±5	
			2,3			±10	
		M,D,P,L,R	1			±5	
Load regulation <u>1/</u>	R _{LOAD}	V _{DIFF} = 3 V, 10 mA ≤ I _L ≤ 1.5 A	1	02		±15	mV
		M,D,P,L,R	1			±15	
		V _{DIFF} = 3.3 V, 10 mA ≤ I _L ≤ 1.5 A	2,3			±15	
		V _{DIFF} = 40V, 10 mA ≤ I _L ≤ 300 mA	1			±15	
			1			±15	
		M,D,P,L,R	1			±15	
Thermal regulation	V _{RTH}	V _{IN} = 14.6 V, I _L = 1.5 A, P _D = 20 watts, t = 20 ms, T _A = +25°C	1	02		±16	mV
		M,D,P,L,R	1			±16	
Ripple rejection <u>2/</u>	R _N	f = 120 Hz, C _{ADJ} = 10 μF, V _{OUT} = V _{REF} , I _{OUT} = 100 mA	4,5,6	02	66		dB
Adjustment pin current	I _{ADJ}	V _{DIFF} = 3.0 V	1	02		100	μA
		M,D,P,L,R	1			100	
		V _{DIFF} = 3.3 V	2,3			100	
		V _{DIFF} = 40 V	1,2,3			100	
			1			100	
		M,D,P,L,R	1,2,3			100	
	1		100				
	M,D,P,L,R	1		100			

See footnotes at end of table.

STANDARD MICROCIRCUIT DRAWING DEFENSE SUPPLY CENTER COLUMBUS COLUMBUS, OHIO 43218-3990	SIZE A		77034
		REVISION LEVEL X	SHEET 11

TABLE I. Electrical performance characteristics - Continued.

Test	Symbol	Conditions -55°C ≤ T _A ≤ +125°C I _L = 8 mA unless otherwise specified	Group A subgroups	Device type	Limits		Unit
					Min	Max	
Cases M, N, T, U, Y, Z - Continued. <u>4/ 5/</u>							
Adjustment pin current change	ΔI _{ADJ}	V _{DIFF} = 3 V, 10 mA ≤ I _L ≤ 1.5 A	1	02		±5	μA
		M,D,P,L,R	1			±5	
		V _{DIFF} = 3.3 V, 10 mA ≤ I _L ≤ 1.5 A	2,3			±5	
		V _{DIFF} = 40 V, 10 mA ≤ I _L ≤ 300 mA	1			±5	
		M,D,P,L,R	1			±5	
		V _{DIFF} = 40 V, 10 mA ≤ I _L ≤ 195 mA	2,3			±5	
		3 V ≤ V _{DIFF} ≤ 40 V	1			±5	
		M,D,P,L,R	1			±5	
		3.3 V ≤ V _{DIFF} ≤ 40 V	2,3			±5	
3.3 V ≤ V _{DIFF} ≤ 60 V	1,2,3		±5				
M,D,P,L,R	1		±5				
Minimum load current	I _{LMIN}	V _{DIFF} = 3.0 V, V _{OUT} = 1.4 V (forced)	1	02		5	mA
		M,D,P,L,R	1			5	
		V _{DIFF} = 3.3 V, V _{OUT} = 1.4 V (forced)	2,3			5	
		V _{DIFF} = 40 V, V _{OUT} = 1.4 V (forced)	1,2,3			5	
		M,D,P,L,R	1			5	
V _{DIFF} = 60 V, V _{OUT} = 1.4 V (forced)	1,2,3		7				
M,D,P,L,R	1		7				
Current limit <u>2/</u>	I _{CL}	V _{DIFF} = 5 V	1,2,3	02	1.5	3.5	A
		M,D,P,L,R	1		1.5	3.5	
		V _{DIFF} = 40 V	1		0.3	1.5	
		M,D,P,L,R	1		0.3	1.5	
		V _{DIFF} = 60 V	1		0.05	0.50	
		M,D,P,L,R	1		0.05	0.50	

See footnotes at end of table.

STANDARD MICROCIRCUIT DRAWING DEFENSE SUPPLY CENTER COLUMBUS COLUMBUS, OHIO 43218-3990	SIZE A		77034
		REVISION LEVEL X	SHEET 12

TABLE I. Electrical performance characteristics - Continued.

Test	Symbol	Conditions -55°C ≤ T _A ≤ +125°C I _L = 8 mA unless otherwise specified	Group A subgroups	Device type	Limits		Unit
					Min	Max	
Cases X, 2, 5, and 6							
Reference voltage	V _{REF}	V _{DIFF} = 3.0 V	1	03	-1.275	-1.225	V
			2,3		-1.30	-1.20	
		V _{DIFF} = 40 V	1		-1.275	-1.225	
			2,3		-1.30	-1.20	
Line regulation	R _{LINE}	3.0 V ≤ V _{DIFF} ≤ 40 V	1	03		±9	mV
			2,3			±23	
Load regulation <u>1/</u>	R _{LOAD}	V _{DIFF} = 5 V, 8 mA ≤ I _L ≤ 200 mA	1,2,3	03		±25	mV
		V _{DIFF} = 15 V, 8 mA ≤ I _L ≤ 200 mA	1,2,3			±25	
		V _{DIFF} = 40V, 8 mA ≤ I _L ≤ 150 mA	1			±25	
		V _{DIFF} = 40 V, 8 mA ≤ I _L ≤ 50 mA	2,3			±25	
Thermal regulation	V _{RTH}	V _{IN} = -16.25 V, I _L = 330 mA, T _A = +25°C P _D = 5 watts, t = 10 ms,	1	03		±2	mV
Ripple rejection <u>2/</u>	R _N	f = 120 Hz, C _{ADJ} = 10 μF, V _{OUT} = V _{REF}	4,5,6	03	66		dB
Adjustment pin current	I _{ADJ}	V _{DIFF} = 3.0 V	1,2,3	03		100	μA
		V _{DIFF} = 40 V	1,2,3			100	
Adjustment pin current change	ΔI _{ADJ} (line)	3.0 V ≤ V _{DIFF} ≤ 40 V	1,2,3	03		±5	μA
	ΔI _{ADJ} (load)	V _{DIFF} = 5.0 V, 8 mA ≤ I _L ≤ 500 mA	1,2,3			±5	
Minimum load current	I _{LMIN}	V _{DIFF} = 3.0 V, V _{OUT} = -1.4 V (forced)	1,2,3	03		3	mA
		V _{DIFF} = 10 V, V _{OUT} = -1.4 V (forced)	1,2,3			3	
		V _{DIFF} = 40 V, V _{OUT} = -1.4 V (forced)	1,2,3			5	
Current limit <u>2/</u>	I _{CL}	V _{DIFF} = 5 V, T _A = +25°C	1	03	0.5	1.8	A
		V _{DIFF} = 40 V, T _A = +25°C	1		0.15	0.65	

See footnotes at end of table.

STANDARD MICROCIRCUIT DRAWING DEFENSE SUPPLY CENTER COLUMBUS COLUMBUS, OHIO 43218-3990	SIZE A		77034
		REVISION LEVEL X	SHEET 13

TABLE I. Electrical performance characteristics - Continued.

Test	Symbol	Conditions -55°C ≤ T _A ≤ +125°C I _L = 8 mA unless otherwise specified	Group A subgroups	Device type	Limits		Unit
					Min	Max	
Cases M, N, T, U, Y, Z							
Reference voltage	V _{REF}	V _{DIFF} = 3.0 V	1	03	-1.275	-1.225	V
			2,3		-1.30	-1.20	
		V _{DIFF} = 40 V	1		-1.275	-1.225	
			2,3		-1.30	-1.20	
Line regulation	R _{LINE}	3.0 V ≤ V _{DIFF} ≤ 40 V	1	03		±9	mV
			2,3			±23	
Load regulation <u>1/</u>	R _{LOAD}	V _{DIFF} = 5 V, 8 mA ≤ I _L ≤ 1.5 A	1,2,3	03		±25	mV
		V _{DIFF} = 12 V, 8 mA ≤ I _L ≤ 1.5 A	1			±25	
		V _{DIFF} = 40V, 8 mA ≤ I _L ≤ 200 mA	1			±25	
		V _{DIFF} = 40 V, 8 mA ≤ I _L ≤ 100 mA	2,3			±25	
Thermal regulation	V _{RTH}	V _{IN} = -14.6 V, I _L = 1.5 A, P _D = 20 watts, t = 10 ms, T _A = +25°C	1	03		±5	mV
Ripple rejection <u>2/</u>	R _N	f = 120 Hz, C _{ADJ} = 10 μF, V _{OUT} = V _{REF}	4,5,6	03	66		dB
Adjustment pin current	I _{ADJ}	V _{DIFF} = 3.0 V	1,2,3	03		100	μA
		V _{DIFF} = 40 V	1,2,3			100	
Adjustment pin current change	ΔI _{ADJ} (line)	3.0 V ≤ V _{DIFF} ≤ 40 V	1,2,3	03		±5	μA
	ΔI _{ADJ} (load)	V _{DIFF} = 5.0 V, 8 mA ≤ I _L ≤ 1.5 A	1,2,3			±5	

See footnotes at end of table.

STANDARD MICROCIRCUIT DRAWING DEFENSE SUPPLY CENTER COLUMBUS COLUMBUS, OHIO 43218-3990	SIZE A		77034
		REVISION LEVEL X	SHEET 14

TABLE I. Electrical performance characteristics - Continued.

Test	Symbol	Conditions -55°C ≤ T _A ≤ +125°C I _L = 8 mA unless otherwise specified	Group A subgroups	Device type	Limits		Unit
					Min	Max	
Cases M, N, T, U, Y, Z - Continued.							
Minimum load current	I _{LMIN}	V _{DIFF} = 3.0 V, V _{OUT} = -1.4 V (forced)	1,2,3	03		3	mA
		V _{DIFF} = 10 V, V _{OUT} = -1.4 V (forced)	1,2,3			3	
		V _{DIFF} = 40 V, V _{OUT} = -1.4 V (forced)	1,2,3			5	
Current limit <u>2/</u>	I _{CL}	V _{DIFF} = 5 V	1,2,3	03	1.5	3.5	A
		V _{DIFF} = 40 V	1		0.24	1.2	
Cases X, 2, 5, and 6							
Reference voltage	V _{REF}	V _{DIFF} = 3.0 V	1	04	-1.275	-1.225	V
			2,3		-1.300	-1.200	
		V _{DIFF} = 40 V	1		-1.275	-1.225	
			2,3		-1.300	-1.200	
		V _{DIFF} = 50 V	1		-1.275	-1.225	
			2,3		-1.300	-1.200	
Line regulation	R _{LINE}	3.0 V ≤ V _{DIFF} ≤ 50 V	1	04		±10	mV
			2,3			±25	
Load regulation <u>1/</u>	R _{LOAD}	V _{DIFF} = 50 V, 8 mA ≤ I _L ≤ 100 mA	1	04		±25	mV
			2,3			±31	
		V _{DIFF} = 5.0 V, 8 mA ≤ I _L ≤ 500 mA	1			±50	
Thermal regulation	V _{RTH}	V _{IN} = -16.25 V, I _L = 330 mA, P _D = 5 watts, t = 10 ms, T _A = +25°C	1	04		±2	mV
			2,3				
Ripple rejection <u>2/</u>	R _N	f = 120 Hz, C _{ADJ} = 10 μF, V _{OUT} = V _{REF}	4,5,6	04	66		dB

See footnotes at end of table.

STANDARD MICROCIRCUIT DRAWING DEFENSE SUPPLY CENTER COLUMBUS COLUMBUS, OHIO 43218-3990	SIZE A		77034
		REVISION LEVEL X	SHEET 15

TABLE I. Electrical performance characteristics - Continued.

Test	Symbol	Conditions -55°C ≤ T _A ≤ +125°C I _L = 8 mA unless otherwise specified	Group A subgroups	Device type	Limits		Unit
					Min	Max	
Cases X, 2, 5, and 6 - Continued.							
Adjustment pin current	I _{ADJ-1}	V _{DIFF} = 3.0 V	1,2,3	04		100	μA
	I _{ADJ-2}	V _{DIFF} = 40 V	1,2,3			100	
	I _{ADJ-3}	V _{DIFF} = 50 V	1,2,3			100	
Adjustment pin current change	ΔI _{ADJ}	V _{DIFF} = 5.0 V, 8 mA ≤ I _{OUT} ≤ 200 mA	1,2,3	04		±5	μA
		I _L = 8 mA, 3.0 V ≤ V _{DIFF} ≤ 50 V	1,2,3			±6	
Minimum load current	I _{LMIN}	V _{DIFF} = 3.0 V, V _{OUT} = -1.4 V (forced)	1,2,3	04		3	mA
		V _{DIFF} = 10 V, V _{OUT} = -1.4 V (forced)	1,2,3			3	
		V _{DIFF} = 40 V, V _{OUT} = -1.4 V (forced)	1,2,3			5	
		V _{DIFF} = 50 V, V _{OUT} = -1.4 V (forced)	1,2,3			5	
Current limit <u>2</u> /	I _{CL}	V _{DIFF} = 5 V	1,2,3	04	0.5	1.8	A
		V _{DIFF} = 50 V	1		0.1	0.65	

Cases M, N, T, U, Y, Z

Reference voltage	V _{REF}	V _{DIFF} = 3.0 V	1	04	-1.275	-1.225	V
			2,3		-1.300	-1.200	
		V _{DIFF} = 50 V	1		-1.275	-1.225	
			2,3		-1.300	-1.200	
Line regulation	R _{LINE}	3.0 V ≤ V _{DIFF} ≤ 50 V	1	04		±10	mV
			2,3			±25	
Load regulation <u>1</u> /	R _{LOAD}	V _{DIFF} = 50 V, 8 mA ≤ I _L ≤ 110 mA	1	04		±25	mV
			2,3			±25	
		V _{DIFF} = 5.0 V, 8 mA ≤ I _L ≤ 1.5 A	1			±25	

See footnotes at end of table.

STANDARD MICROCIRCUIT DRAWING DEFENSE SUPPLY CENTER COLUMBUS COLUMBUS, OHIO 43218-3990	SIZE A		77034
		REVISION LEVEL X	SHEET 16

TABLE I. Electrical performance characteristics - Continued.

Test	Symbol	Conditions -55°C ≤ T _A ≤ +125°C I _L = 8 mA unless otherwise specified	Group A subgroups	Device type	Limits		Unit
					Min	Max	
Case M, N, T, U, Y, Z - Continued.							
Thermal regulation	V _{RTH}	V _{IN} = -14.6 V, I _L = 1.5 A, P _D = 20 watts, t = 10 ms, T _A = +25°C	1	04		±5	mV
Ripple rejection <u>2/</u>	R _N	f = 120 Hz, C _{ADJ} = 10 μF, V _{OUT} = V _{REF}	4,5,6	04	66		dB
Adjustment pin current	I _{ADJ-1}	V _{DIFF} = 3.0 V	1,2,3	04		100	μA
	I _{ADJ-2}	V _{DIFF} = 40 V	1,2,3			100	
	I _{ADJ-3}	V _{DIFF} = 50 V	1,2,3			100	
Adjustment pin current change	ΔI _{ADJ}	V _{DIFF} = 5.0 V, 8 mA ≤ I _{OUT} ≤ 1.5 A	1,2,3	04		±5	μA
		I _L = 8 mA, 3.0 V ≤ V _{DIFF} ≤ 50 V	1,2,3			±6	
Minimum load current	I _{LMIN}	V _{DIFF} = 3.0 V, V _{OUT} = -1.4 V (forced)	1,2,3	04		3	mA
		V _{DIFF} = 10 V, V _{OUT} = -1.4 V (forced)	1,2,3			3	
		V _{DIFF} = 40 V, V _{OUT} = -1.4 V (forced)	1,2,3			5	
		V _{DIFF} = 50 V, V _{OUT} = -1.4 V (forced)	1,2,3			5	
Current limit <u>2/</u>	I _{CL}	V _{DIFF} = 5 V	1,2,3	04	1.5	3.5	A
		V _{DIFF} = 50 V	1		0.2	1.0	

Cases X, 2, 5, and 6

Reference voltage	V _{REF}	V _{DIFF} = 3.0 V	1	05	1.238	1.262	V
		V _{DIFF} = 3.3 V	2,3		1.225	1.270	
		V _{DIFF} = 40 V	1,2,3		1.225	1.270	

See footnotes at the end table.

STANDARD MICROCIRCUIT DRAWING DEFENSE SUPPLY CENTER COLUMBUS COLUMBUS, OHIO 43218-3990	SIZE A		77034
		REVISION LEVEL X	SHEET 17

TABLE I. Electrical performance characteristics - Continued.

Test	Symbol	Conditions -55°C ≤ T _A ≤ +125°C I _L = 8 mA unless otherwise specified	Group A subgroups	Device type	Limits		Unit
					Min	Max	
Cases X, 2, 5, and 6 - Continued.							
Line regulation	R _{LINE}	V _{OUT} = V _{REF} , 3.0 V ≤ V _{DIFF} ≤ 40 V	1	05		±4.5	mV
		V _{OUT} = V _{REF} , 3.3 V ≤ V _{DIFF} ≤ 40 V	2,3			±9	
Load regulation <u>1/</u>	R _{LOAD}	V _{DIFF} = 3 V, 10 mA ≤ I _L ≤ 500 mA	1	05		±15	mV
		V _{DIFF} = 3.3 V, 10 mA ≤ I _L ≤ 500 mA	2,3			±15	
		V _{DIFF} = 40 V, 10 mA ≤ I _L ≤ 150 mA	1			±15	
		V _{DIFF} = 40 V, 10 mA ≤ I _L ≤ 100 mA	2,3			±15	
Thermal regulation	V _{RTH}	V _{IN} = +14.6 V, I _L = 300 mA, P _D = 4 watts, t = 20 ms, T _A = +25°C	1	05		±2	mV
Ripple rejection <u>2/</u>	R _N	f = 120 Hz, C _{ADJ} = 10 μF, V _{OUT} = V _{REF}	4,5,6	05	66		dB
Adjustment pin current	I _{ADJ}	V _{DIFF} = 3.0 V	1	05		100	μA
		V _{DIFF} = 3.3 V	2,3			100	
		V _{DIFF} = 40 V	1,2,3			100	
Adjustment pin current change	ΔI _{ADJ}	V _{DIFF} = 3 V, 10 mA ≤ I _L ≤ 500 mA	1	05		±5	μA
		V _{DIFF} = 3.3 V, 10 mA ≤ I _L ≤ 500 mA	2,3			±5	
		V _{DIFF} = 40 V, 10 mA ≤ I _L ≤ 150 mA	1			±5	
		V _{DIFF} = 40 V, 10 mA ≤ I _L ≤ 100 mA	2,3			±5	
		3.0 V ≤ V _{DIFF} ≤ 40 V	1			±5	
		3.3 V ≤ V _{DIFF} ≤ 40 V	2,3			±5	

See footnotes at end of table.

STANDARD MICROCIRCUIT DRAWING DEFENSE SUPPLY CENTER COLUMBUS COLUMBUS, OHIO 43218-3990	SIZE A		77034
		REVISION LEVEL X	SHEET 18

TABLE I. Electrical performance characteristics - Continued.

Test	Symbol	Conditions -55°C ≤ T _A ≤ +125°C I _L = 8 mA unless otherwise specified	Group A subgroups	Device type	Limits		Unit
					Min	Max	
Cases X, 2, 5, and 6 - Continued.							
Minimum load current	I _{LMIN}	V _{DIFF} = 3.0 V, V _{OUT} = 1.4 V (forced)	1	05		5	mA
		V _{DIFF} = 3.3 V, V _{OUT} = 1.4 V (forced)	2,3			5	
		V _{DIFF} = 40 V, V _{OUT} = 1.4 V (forced)	1,2,3			5	
Current limit <u>2/</u>	I _{CL}	V _{DIFF} = 15 V	1,2,3	05	0.5	1.65	A
		V _{DIFF} = 40 V	1		0.15	0.65	
Cases M, N, T, U, Y, Z							
Reference voltage	V _{REF}	V _{DIFF} = 3.0 V	1	05	1.238	1.262	V
		V _{DIFF} = 3.3 V	2,3		1.225	1.270	
		V _{DIFF} = 40 V	1,2,3		1.225	1.270	
Line regulation	R _{LINE}	V _{OUT} = V _{REF} , 3.0 V ≤ V _{DIFF} ≤ 40 V	1	05		±4.5	mV
		V _{OUT} = V _{REF} , 3.3 V ≤ V _{DIFF} ≤ 40 V	2,3			±9	
Load regulation <u>1/</u>	R _{LOAD}	V _{DIFF} = 3 V, 10 mA ≤ I _L ≤ 1.5 A	1	05		±15	mV
		V _{DIFF} = 3.3 V, 10 mA ≤ I _L ≤ 1.5 A	2,3			±15	
		V _{DIFF} = 40 V, 10 mA ≤ I _L ≤ 300 mA	1			±15	
		V _{DIFF} = 40 V, 10 mA ≤ I _L ≤ 195 mA	2,3			±15	
Thermal regulation	V _{RTH}	V _{IN} = +14.6 V, I _L = 1.5 A, P _D = 20 watts, t = 20 ms, T _A = +25°C	1	05		±5	mV

See footnotes at end of table.

STANDARD MICROCIRCUIT DRAWING DEFENSE SUPPLY CENTER COLUMBUS COLUMBUS, OHIO 43218-3990	SIZE A		77034
		REVISION LEVEL X	SHEET 19

TABLE I. Electrical performance characteristics - Continued.

Test	Symbol	Conditions -55°C ≤ T _A ≤ +125°C I _L = 8 mA unless otherwise specified	Group A subgroups	Device type	Limits		Unit
					Min	Max	
Cases M, N, T, U, Y, Z - Continued.							
Ripple rejection <u>2/</u>	R _N	f = 120 Hz, C _{ADJ} = 10 μF, V _{OUT} = V _{REF}	4,5,6	05	66		dB
Adjustment pin current	I _{ADJ}	V _{DIFF} = 3.0 V	1	05		100	μA
		V _{DIFF} = 3.3 V	2,3			100	
		V _{DIFF} = 40 V	1,2,3			100	
Adjustment pin current change	ΔI _{ADJ}	V _{DIFF} = 3 V, 10 mA ≤ I _L ≤ 1.5 A	1	05		±5	μA
		V _{DIFF} = 3.3 V, 10 mA ≤ I _L ≤ 1.5 A	2,3			±5	
		V _{DIFF} = 40 V, 10 mA ≤ I _L ≤ 300 mA	1			±5	
		V _{DIFF} = 40 V, 10 mA ≤ I _L ≤ 195 mA	2,3			±5	
		3.0 V ≤ V _{DIFF} ≤ 40 V	1			±5	
		3.3 V ≤ V _{DIFF} ≤ 40 V	2,3			±5	
Minimum load current	I _{LMIN}	V _{DIFF} = 3.0 V, V _{OUT} = 1.4 V (forced)	1	05		5	mA
		V _{DIFF} = 3.3 V, V _{OUT} = 1.4 V (forced)	2,3			5	
		V _{DIFF} = 40 V, V _{OUT} = 1.4 V (forced)	1,2,3			5	
Current limit <u>2/</u>	I _{CL}	V _{DIFF} = 15 V	1,2,3	05	1.50	3.50	A
		V _{DIFF} = 40 V	1		0.18	1.5	

Cases X, 2, 5, and 6

Reference voltage	V _{REF}	V _{DIFF} = 3.0 V	1	06	-1.262	-1.238	V
			2,3		-1.280	-1.220	
		V _{DIFF} = 40 V	1,2,3		-1.280	-1.220	

See footnotes at end of table.

STANDARD MICROCIRCUIT DRAWING DEFENSE SUPPLY CENTER COLUMBUS COLUMBUS, OHIO 43218-3990	SIZE A		77034
		REVISION LEVEL X	SHEET 20

TABLE I. Electrical performance characteristics - Continued.

Test	Symbol	Conditions -55°C ≤ T _A ≤ +125°C I _L = 8 mA unless otherwise specified	Group A subgroups	Device type	Limits		Unit
					Min	Max	
Cases X, 2, 5, and 6 - Continued.							
Line regulation	R _{LINE}	3.0 V ≤ V _{DIFF} ≤ 40 V	1	06		±4.5	mV
			2,3			±13.8	
Load regulation <u>1/</u>	R _{LOAD}	V _{DIFF} = 5 V, 8 mA ≤ I _L ≤ 200 mA	1,2,3	06		±25	mV
		V _{DIFF} = 15 V, 8 mA ≤ I _L ≤ 200 mA	1,2,3			±25	
		V _{DIFF} = 40 V, 8 mA ≤ I _L ≤ 150 mA	1			±25	
		V _{DIFF} = 40 V, 8 mA ≤ I _L ≤ 50 mA	2,3			±50	
Thermal regulation	V _{RTH}	V _{IN} = -16.25 V, I _L = 330 mA, T _A = +25°C P _D = 5 watts, t = 10 ms	1	06		±2	mV
Ripple rejection <u>2/</u>	R _N	f = 120 Hz, C _{ADJ} = 10 μF, V _{OUT} = V _{REF}	4,5,6	06	66		dB
Adjustment pin current	I _{ADJ}	V _{DIFF} = 3.0 V	1,2,3,	06		100	μA
		V _{DIFF} = 40 V	1,2,3			100	
Adjustment pin current change	ΔI _{ADJ} (line)	3.0 V ≤ V _{DIFF} ≤ 40 V	1,2,3	06		±5	μA
	ΔI _{ADJ} (load)	V _{DIFF} = 5.0 V, 8 mA ≤ I _L ≤ 500 mA	1,2,3			±5	
Minimum load current	I _{LMIN}	V _{DIFF} = 3.0 V, V _{OUT} = -1.4 V (forced)	1,2,3	06		3	mA
		V _{DIFF} = 10 V, V _{OUT} = -1.4 V (forced)	1,2,3			3	
		V _{DIFF} = 40 V, V _{OUT} = -1.4 V (forced)	1,2,3			5	
Current limit <u>2/</u>	I _{CL}	V _{DIFF} = 5 V, T _A = +25°C	1	06	0.5	1.8	A
		V _{DIFF} = 40 V, T _A = +25°C	1		0.15	0.65	

See footnotes at end of table.

STANDARD MICROCIRCUIT DRAWING DEFENSE SUPPLY CENTER COLUMBUS COLUMBUS, OHIO 43218-3990	SIZE A		77034
		REVISION LEVEL X	SHEET 21

TABLE I. Electrical performance characteristics - Continued.

Test	Symbol	Conditions -55°C ≤ T _A ≤ +125°C I _L = 8 mA unless otherwise specified	Group A subgroups	Device type	Limits		Unit
					Min	Max	
Cases M, N, T, U, Y, Z							
Reference voltage	V _{REF}	V _{DIFF} = 3.0 V	1	06	-1.262	-1.238	V
			2,3		-1.280	-1.220	
		V _{DIFF} = 40 V	1,2,3		-1.280	-1.220	
Line regulation	R _{LINE}	3.0 V ≤ V _{DIFF} ≤ 40 V	1	06		±4.5	mV
			2,3			±13.8	
Load regulation <u>1/</u>	R _{LOAD}	V _{DIFF} = 5 V, 8 mA ≤ I _L ≤ 1.5 A	1,2,3	06		±25	mV
		V _{DIFF} = 12 V, 8 mA ≤ I _L ≤ 1.5 A	1			±25	
		V _{DIFF} = 40 V, 8 mA ≤ I _L ≤ 200 mA	1			±25	
		V _{DIFF} = 40 V, 8 mA ≤ I _L ≤ 100 mA	2,3			±50	
Thermal regulation	V _{RTH}	V _{IH} = -14.6 V, I _L = 1.5 A, P _D = 20 watts, t = 10 ms, T _A = +25°C	1	06		±5	mV
Ripple rejection <u>2/</u>	R _N	f = 120 Hz, C _{ADJ} = 10 μF, V _{OUT} = V _{REF}	4,5,6	06	66		dB
Adjustment pin current	I _{ADJ}	V _{DIFF} = 3.0 V	1,2,3,	06		100	μA
		V _{DIFF} = 40 V	1,2,3			100	
Adjustment pin current change	ΔI _{ADJ} (line)	3.0 V ≤ V _{DIFF} ≤ 40 V	1,2,3	06		±5	μA
	ΔI _{ADJ} (load)	V _{DIFF} = 5.0 V, 8 mA ≤ I _L ≤ 1.5 A	1,2,3			±5	
Minimum load current	I _{LMIN}	V _{DIFF} = 3.0 V, V _{OUT} = -1.4 V (forced)	1,2,3	06		3	mA
		V _{DIFF} = 10 V, V _{OUT} = -1.4 V (forced)	1,2,3			3	
		V _{DIFF} = 40 V, V _{OUT} = -1.4 V (forced)	1,2,3			5	
Current limit <u>2/</u>	I _{CL}	V _{DIFF} = 5 V	1,2,3	06	1.5	3.5	A
		V _{DIFF} = 40 V, T _A = +25°C	1		0.24	1.2	

See footnotes at end of table.

STANDARD MICROCIRCUIT DRAWING DEFENSE SUPPLY CENTER COLUMBUS COLUMBUS, OHIO 43218-3990	SIZE A		77034
		REVISION LEVEL X	SHEET 22

TABLE I. Electrical performance characteristics - Continued.

Test	Symbol	Conditions -55°C ≤ T _A ≤ +125°C I _L = 8 mA unless otherwise specified	Group A subgroups	Device type	Limits		Unit
					Min	Max	
Cases X, 2, 5, and 6							
Reference voltage	V _{REF}	V _{DIFF} = 3.0 V	1	07	1.238	1.262	V
		V _{DIFF} = 3.3 V	2,3		1.225	1.27	
		V _{DIFF} = 40 V	1,2,3		1.225	1.27	
		V _{DIFF} = 60 V	1,2,3		1.225	1.27	
Line regulation <u>3/</u>	R _{LINE}	V _{OUT} = V _{REF} 3.0 V ≤ V _{DIFF} ≤ 40 V	1	07		±4.5	mV
		V _{OUT} = V _{REF} 3.3 V ≤ V _{DIFF} ≤ 40 V	2,3			±9	
		V _{OUT} = V _{REF} 40 V ≤ V _{DIFF} ≤ 60 V	1			±2.5	
			2,3			±4.0	
Load regulation <u>1/</u>	R _{LOAD}	V _{DIFF} = 3 V, 10 mA ≤ I _L ≤ 500 mA	1	07		±15	mV
		V _{DIFF} = 3.3 V, 10 mA ≤ I _L ≤ 500 mA	2,3			±15	
		V _{DIFF} = 40 V, 10 mA ≤ I _L ≤ 150 mA	1			±15	
		V _{DIFF} = 40 V, 10 mA ≤ I _L ≤ 100 mA	2,3			±15	
		V _{DIFF} = 60 V, 10 mA ≤ I _L ≤ 20 mA	1,2,3			±15	
Thermal regulation	V _{RTH}	V _{IN} = 14.6 V, I _L = 300 mA, P _D = 4 watts, t = 20 ms, T _A = +25°C	1	07		±2	mV
Ripple rejection <u>2/</u>	R _N	f = 120 Hz, C _{ADJ} = 10 μF, V _{OUT} = V _{REF} , I _{OUT} = 100 mA	4,5,6	07	66		dB
Adjustment pin current	I _{ADJ}	V _{DIFF} = 3.0 V	1	07		100	μA
		V _{DIFF} = 3.3 V	2,3			100	
		V _{DIFF} = 40 V	1,2,3			100	
		V _{DIFF} = 60 V	1,2,3			100	

See footnotes at end of table.

STANDARD MICROCIRCUIT DRAWING DEFENSE SUPPLY CENTER COLUMBUS COLUMBUS, OHIO 43218-3990	SIZE A		77034
		REVISION LEVEL X	SHEET 23

TABLE I. Electrical performance characteristics - Continued.

Test	Symbol	Conditions -55°C ≤ T _A ≤ +125°C I _L = 8 mA unless otherwise specified	Group A subgroups	Device type	Limits		Unit
					Min	Max	
Cases X, 2, 5, and 6 - Continued.							
Adjustment pin current change	ΔI _{ADJ}	V _{DIFF} = 3 V, 10 mA ≤ I _L ≤ 500 mA	1	07		±5	μA
		V _{DIFF} = 3.3 V, 10 mA ≤ I _L ≤ 500 mA	2,3			±5	
		V _{DIFF} = 40 V, 10 mA ≤ I _L ≤ 150 mA	1			±5	
		V _{DIFF} = 40 V, 10 mA ≤ I _L ≤ 100 mA	2,3			±5	
		3.0 V ≤ V _{DIFF} ≤ 40 V	1			±5	
		3.3 V ≤ V _{DIFF} ≤ 40 V	2,3			±5	
		3.3 V ≤ V _{DIFF} ≤ 60 V	1,2,3			±5	
Minimum load current	I _{LMIN}	V _{DIFF} = 3.0 V, V _{OUT} = 1.4 V (forced)	1	07		5	mA
		V _{DIFF} = 3.3 V, V _{OUT} = 1.4 V (forced)	2,3			5	
		V _{DIFF} = 40 V, V _{OUT} = 1.4 V (forced)	1,2,3			5	
		V _{DIFF} = 60 V, V _{OUT} = 1.4 V (forced)	1,2,3			7	
Current limit <u>2</u> /	I _{CL}	V _{DIFF} = 5 V	1,2,3	07	0.50	1.65	A
		V _{DIFF} = 40 V	1		0.15	0.65	
		V _{DIFF} = 60 V	1		0.02	0.28	

Cases M, N, T, U, Y, Z, 4 4/ 5/

Reference voltage	V _{REF}	V _{DIFF} = 3.0 V	1	07	1.238	1.262	V
		M,D,P,L,R	1		1.238	1.262	
		V _{DIFF} = 3.3 V	2,3		1.225	1.27	
		V _{DIFF} = 40 V	1,2,3		1.225	1.27	
		M,D,P,L,R	1		1.225	1.27	
		V _{DIFF} = 60 V	1,2,3		1.225	1.27	
		M,D,P,L,R	1		1.225	1.27	

See footnotes at end of table.

STANDARD MICROCIRCUIT DRAWING DEFENSE SUPPLY CENTER COLUMBUS COLUMBUS, OHIO 43218-3990	SIZE A		77034
		REVISION LEVEL X	SHEET 24

TABLE I. Electrical performance characteristics - Continued.

Test	Symbol	Conditions -55°C ≤ T _A ≤ +125°C I _L = 8 mA unless otherwise specified	Group A subgroups	Device type	Limits		Unit								
					Min	Max									
Cases M, N, T, U, Y, Z, 4 – Continued <u>4/ 5/</u>															
Line regulation <u>3/</u>	R _{LINE}	V _{OUT} = V _{REF} 3.0 V ≤ V _{DIFF} ≤ 40 V	1	07		±4.5	mV								
		M,D,P,L,R	1			±4.5									
		V _{OUT} = V _{REF} 3.3 V ≤ V _{DIFF} ≤ 40 V	2,3			±9									
		V _{OUT} = V _{REF} 40 V ≤ V _{DIFF} ≤ 60 V	1			±5									
		M,D,P,L,R	2,3			±10									
		M,D,P,L,R	1			±5									
Load regulation <u>1/</u>	R _{LOAD}	V _{DIFF} = 3 V, 10 mA ≤ I _L ≤ 1.5 A	1	07		±15	mV								
		M,D,P,L,R	1			±15									
		V _{DIFF} = 3.3 V, 10 mA ≤ I _L ≤ 1.5 A	2,3			±15									
		V _{DIFF} = 40 V, 10 mA ≤ I _L ≤ 300 mA	1			±15									
		M,D,P,L,R	1			±15									
		V _{DIFF} = 40 V, 10 mA ≤ I _L ≤ 195 mA	2,3			±15									
Thermal regulation	V _{RTH}	V _{IN} = 14.6 V, I _L = 1.5 A, P _D = 20 watts, t = 20 ms, T _A = +25°C	1	07		±5	mV								
		M,D,P,L,R	1			±5									
		Ripple rejection <u>2/</u>	R _N		f = 120 Hz, C _{ADJ} = 10 μF, V _{OUT} = V _{REF} , I _{OUT} = 100 mA	4,5,6		07	66		dB				
					Adjustment pin current	I _{ADJ}			V _{DIFF} = 3.0 V	1		07		100	μA
									M,D,P,L,R	1				100	
									V _{DIFF} = 3.3 V	2,3				100	
V _{DIFF} = 40 V	1,2,3		100												
M,D,P,L,R	1		100												
V _{DIFF} = 60 V	1,2,3		100												
M,D,P,L,R	1		100												

See footnotes at end of table.

STANDARD MICROCIRCUIT DRAWING DEFENSE SUPPLY CENTER COLUMBUS COLUMBUS, OHIO 43218-3990	SIZE A		77034
		REVISION LEVEL X	SHEET 25

TABLE I. Electrical performance characteristics - Continued.

Test	Symbol	Conditions -55°C ≤ T _A ≤ +125°C I _L = 8 mA unless otherwise specified	Group A subgroups	Device type	Limits		Unit				
					Min	Max					
Cases M, N, T, U, Y, Z, 4 – Continued <u>4/ 5/</u>											
Adjustment pin current change	ΔI _{ADJ}	V _{DIFF} = 3 V, 10 mA ≤ I _L ≤ 1.5 A	1	07		±5	μA				
		M,D,P,L,R	1			±5					
		V _{DIFF} = 3.3 V, 10 mA ≤ I _L ≤ 1.5 A	2,3			±5					
		V _{DIFF} = 40 V, 10 mA ≤ I _L ≤ 300 mA	1			±5					
		M,D,P,L,R	1			±5					
		V _{DIFF} = 40 V, 10 mA ≤ I _L ≤ 195 mA	2,3			±5					
		3.0 V ≤ V _{DIFF} ≤ 40 V	1			±5					
		M,D,P,L,R	1			±5					
		3.3 V ≤ V _{DIFF} ≤ 40 V	2,3			±5					
Minimum load current	I _{LMIN}	V _{DIFF} = 3.0 V, V _{OUT} = 1.4 V (forced)	1	07		5	mA				
		M,D,P,L,R	1			5					
		V _{DIFF} = 3.3 V, V _{OUT} = 1.4 V (forced)	2,3			5					
		V _{DIFF} = 40 V, V _{OUT} = 1.4 V (forced)	1,2,3			5					
		M,D,P,L,R	1			5					
		V _{DIFF} = 60 V, V _{OUT} = 1.4 V (forced)	1,2,3			7					
		M,D,P,L,R	1			7					
		Current limit <u>2/</u>	I _{CL}		V _{DIFF} = 5 V	1,2,3		07	1.50	3.5	A
					M,D,P,L,R	1			1.50	3.5	
V _{DIFF} = 40 V	1			0.3	1.5						
M,D,P,L,R	1			0.3	1.5						
V _{DIFF} = 60 V	1			0.05	0.50						
M,D,P,L,R	1			0.05	0.50						

See footnotes at end of table.

STANDARD MICROCIRCUIT DRAWING DEFENSE SUPPLY CENTER COLUMBUS COLUMBUS, OHIO 43218-3990	SIZE A		77034
		REVISION LEVEL X	SHEET 26

TABLE I. Electrical performance characteristics - Continued.

Test	Symbol	Conditions -55°C ≤ T _A ≤ +125°C I _L = 8 mA unless otherwise specified	Group A subgroups	Device type	Limits		Unit
					Min	Max	
Cases X, 2, 5, and 6							
Reference voltage	V _{REF}	V _{DIFF} = 3.0 V	1	08	-1.262	-1.235	V
			2,3		-1.28	-1.22	
		V _{DIFF} = 40 V	1		-1.28	-1.22	
			2,3		-1.28	-1.22	
		V _{DIFF} = 50 V	1		-1.28	-1.22	
			2,3		-1.28	-1.22	
Line regulation	R _{LINE}	3.0 V ≤ V _{DIFF} ≤ 50 V	1	08		±10	mV
			2,3			±25	
Load regulation <u>1/</u>	R _{LOAD}	V _{DIFF} = 50 V, 8 mA ≤ I _L ≤ 100 mA	1	08		±25	mV
			2,3			±31	
		V _{DIFF} = 5.0 V, 8 mA ≤ I _L ≤ 500 mA	1			±50	
Thermal regulation	V _{RTH}	V _{IN} = -16.25 V, I _L = 330 mA, T _A = +25°C, P _D = 5 watts, t = 10 ms	1	08		±2	mV
Ripple rejection <u>2/</u>	R _N	f = 120 Hz, C _{ADJ} = 10 μF, V _{OUT} = V _{REF}	4,5,6	08	66		dB
Adjustment pin current	I _{ADJ-1} I _{ADJ-2} I _{ADJ-3}	V _{DIFF} = 3.0 V	1,2,3	08		100	μA
			1,2,3			100	
			1,2,3			100	
Adjustment pin current change	ΔI _{ADJ}	V _{DIFF} = 5 V, 8 mA ≤ I _{OUT} ≤ 200 mA	1,2,3	08		±5	μA
			1,2,3			±6	
Minimum load current	I _{LMIN}	V _{DIFF} = 3.0 V, V _{OUT} = -1.4 V (forced)	1,2,3	08		3	mA
			1,2,3			3	
		V _{DIFF} = 40 V, V _{OUT} = -1.4 V (forced)	1,2,3			5	
			1,2,3			5	
Current limit <u>2/</u>	I _{CL}	V _{DIFF} = 5 V	1,2,3	08	0.5	1.8	A
			1		0.1	0.65	

See footnotes at end of table.

STANDARD MICROCIRCUIT DRAWING DEFENSE SUPPLY CENTER COLUMBUS COLUMBUS, OHIO 43218-3990	SIZE A		77034
		REVISION LEVEL X	SHEET 27

TABLE I. Electrical performance characteristics - Continued.

Test	Symbol	Conditions -55°C ≤ T _A ≤ +125°C I _L = 8 mA unless otherwise specified	Group A subgroups	Device type	Limits		Unit
					Min	Max	
Cases M, N, T, U, Y, Z							
Reference voltage	V _{REF}	V _{DIFF} = 3.0 V	1	08	-1.262	-1.238	V
			2,3		-1.28	-1.22	
		V _{DIFF} = 50 V	1		-1.28	-1.22	
			2,3		-1.28	-1.22	
Line regulation	R _{LINE}	3.0 V ≤ V _{DIFF} ≤ 50 V	1	08		±6	mV
			2,3			±20	
Load regulation <u>1/</u>	R _{LOAD}	V _{DIFF} = 50 V, 8 mA ≤ I _L ≤ 110 mA	1	08		±25	mV
		V _{DIFF} = 5.0 V, 8 mA ≤ I _L ≤ 1.5 A	1			±25	
			2,3			±50	
Thermal regulation	V _{RTH}	V _{IN} = -14.6 V, I _L = 1.5 A, P _D = 20 watts, t = 10 ms, T _A = +25°C	1	08		±5	mV
Ripple rejection <u>2/</u>	R _N	f = 120 Hz, C _{ADJ} = 10 μF, V _{OUT} = V _{REF}	4,5,6	08	66		dB
Adjustment pin current	I _{ADJ-1}	V _{DIFF} = 3.0 V	1,2,3	08		100	μA
	I _{ADJ-2}	V _{DIFF} = 40 V	1,2,3			100	
	I _{ADJ-3}	V _{DIFF} = 50 V	1,2,3			100	
Adjustment pin current change	ΔI _{ADJ}	V _{DIFF} = 5 V, 8 mA ≤ I _{OUT} ≤ 1.5 A	1,2,3	08		±5	μA
		I _L = 8 mA, 3.0 V ≤ V _{DIFF} ≤ 50 V	1,2,3			±6	
Minimum load current	I _{LMIN}	V _{DIFF} = 3.0 V, V _{OUT} = -1.4 V (forced)	1,2,3	08		3	mA
		V _{DIFF} = 10 V, V _{OUT} = -1.4 V (forced)	1,2,3			3	
		V _{DIFF} = 40 V, V _{OUT} = -1.4 V (forced)	1,2,3			5	
		V _{DIFF} = 50 V, V _{OUT} = -1.4 V (forced)	1,2,3			5	
Current limit <u>2/</u>	I _{CL}	V _{DIFF} = 5 V	1,2,3	08	1.5	3.5	A
		V _{DIFF} = 50 V	1		0.2	1.0	

See footnotes at end of table.

STANDARD MICROCIRCUIT DRAWING DEFENSE SUPPLY CENTER COLUMBUS COLUMBUS, OHIO 43218-3990	SIZE A		77034
		REVISION LEVEL X	SHEET 28

TABLE I. Electrical performance characteristics - Continued.

- 1/ Regulation is measured at a constant junction temperature, using pulse testing with a low duty cycle. Changes in output voltage due to heating effects are covered under the specification for thermal regulation. With exception of cases U, 2, and 4, all output measurements are referenced to the case. Measurements taken at the output lead must be adjusted for lead resistance.
- 2/ If not tested, shall be guaranteed to the specified limits in table herein.
- 3/ To determine the line regulation limits for $3.0\text{ V} \leq V_{\text{DIFF}} \leq 60\text{ V}$ (or $3.3\text{ V} \leq V_{\text{DIFF}} \leq 60\text{ V}$) add the limits for $3.0\text{ V} \leq V_{\text{DIFF}} \leq 40\text{ V}$ (or $3.3\text{ V} \leq V_{\text{DIFF}} \leq 40\text{ V}$) to the limits for $40\text{ V} \leq V_{\text{DIFF}} \leq 60\text{ V}$.
- 4/ Device types 02 and 07 with case outline U supplied to this drawing have been characterized through all levels M, D, P, L, and R of irradiation. However, these devices are only tested at the 'R' level. Pre and post irradiation values are identical unless otherwise specified in table I. When performing post irradiation electrical measurements for any RHA level, $T_A = +25^\circ\text{C}$.
- 5/ These parts may be dose rate sensitive in a space environment and demonstrate enhanced low dose rate effect. Radiation end point limits for the noted parameters are guaranteed only for the conditions as specified in MIL-STD-883, method 1019 condition A.

STANDARD MICROCIRCUIT DRAWING DEFENSE SUPPLY CENTER COLUMBUS COLUMBUS, OHIO 43218-3990	SIZE A		77034
		REVISION LEVEL X	SHEET 29

Case outline M

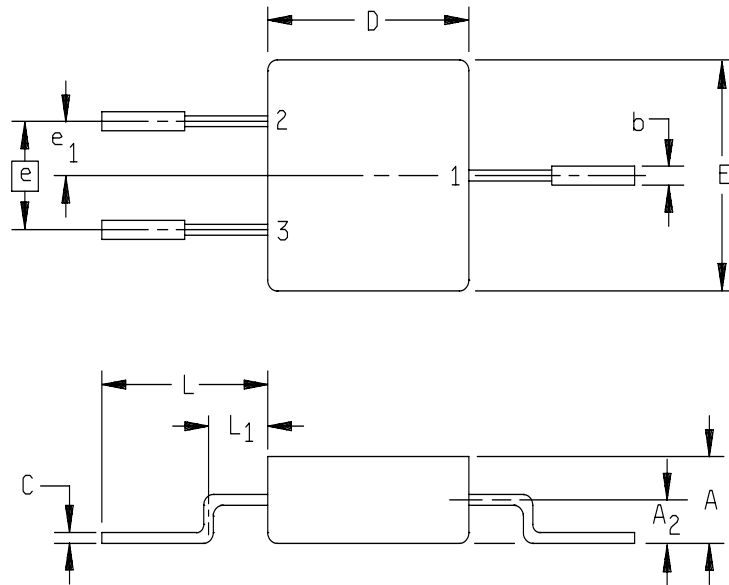

Device types	All
Terminal number	Terminal symbol
1	V_{OUT}
2	ADJUST
3	V_{IN}
CASE	ISOLATED

Symbol	Inches		Millimeters	
	Min	Max	Min	Max
A	.160	---	4.06	---
A_2	.080	---	2.03	---
b	---	.035	---	0.89
C	.020	---	0.51	---
D	---	.425	---	10.8
E	---	.425	---	10.8
e	.200 BSC		5.08 BSC	
e_1	.100 BSC		2.54 BSC	
L	.350	---	8.89	---
L_1	---	.135	---	3.43

NOTES:

1. Dimensions shall be measured in inches.
2. Metric equivalents are given for general information only.
3. Three leads.

FIGURE 1. Case outlines and terminal connections.

STANDARD MICROCIRCUIT DRAWING DEFENSE SUPPLY CENTER COLUMBUS COLUMBUS, OHIO 43218-3990	SIZE A		77034
		REVISION LEVEL X	SHEET 30

Case outline N

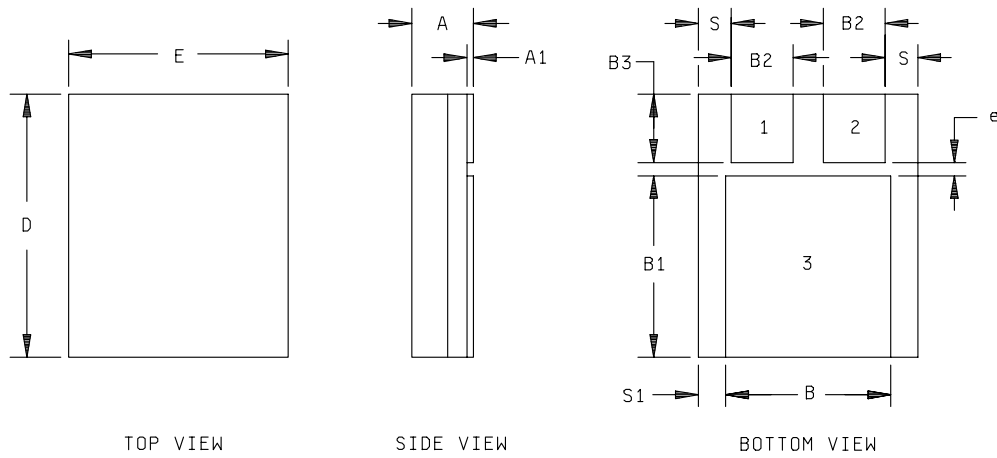

Device types	01, 02, 05, 07	03, 04, 06, 08
Case outline	N	
Terminal number	Terminal symbol	
1	ADJUST	ADJUST
2	INPUT	OUTPUT
3	OUTPUT	INPUT

Symbol	Inches		Millimeters	
	Min	Max	Min	Max
A	.130	.150	3.30	3.81
A1	.010	.020	0.25	0.51
B	.370	.380	9.40	9.65
B1	.410	.420	10.41	10.67
B2	.135	.145	3.43	3.68
B3	.152	.162	3.86	4.11
D	.620	.630	15.75	16.00
E	.445	.455	11.30	11.55
e	.030	---	0.76	---
S	.045	.055	1.14	1.40
S1	.035	.045	0.89	1.14

NOTE:

The U.S. government preferred system of measurement is the metric SI system. However, since this item was originally designed using inch-pound units of measurement, in the event of conflict between the metric and inch-pound units, the inch-pound units shall take precedence.

FIGURE 1. Case outlines and terminal connections – Continued.

STANDARD MICROCIRCUIT DRAWING DEFENSE SUPPLY CENTER COLUMBUS COLUMBUS, OHIO 43218-3990	SIZE A		77034
		REVISION LEVEL X	SHEET 31

Case outlines T and U

Device types	01, 02, 05, 07	01, 02, 05, 07	03, 04, 06, 08	
Case outlines	T	U	T	U
Terminal number	Terminal symbol			
1	ADJUST	ADJUST	ADJUST	ADJUST
2	V _{OUT}	V _{OUT}	V _{IN}	V _{IN}
3	V _{IN}	V _{IN}	V _{OUT}	V _{OUT}
4	V _{OUT}	NC	V _{IN}	NC

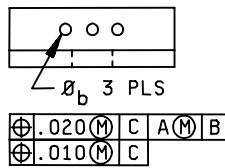
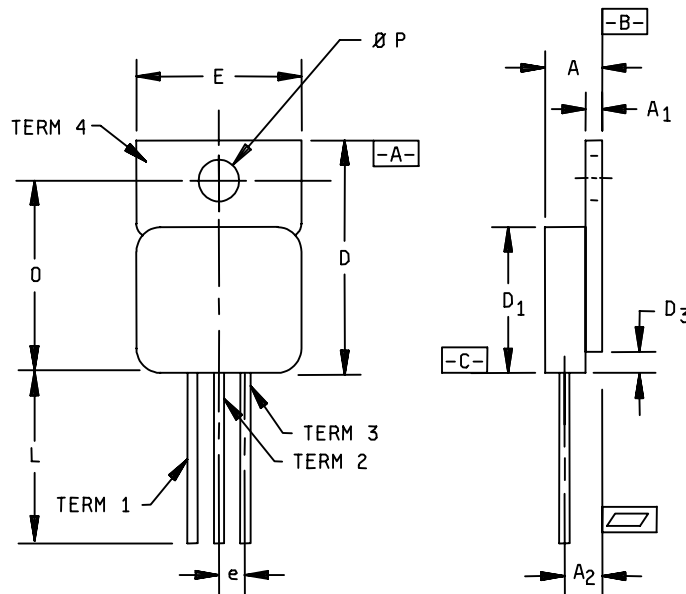

FIGURE 1. Case outlines and terminal connections - Continued.

<p>STANDARD MICROCIRCUIT DRAWING DEFENSE SUPPLY CENTER COLUMBUS COLUMBUS, OHIO 43218-3990</p>	<p>SIZE A</p>		<p>77034</p>
		<p>REVISION LEVEL X</p>	<p>SHEET 32</p>

Case outlines T and U

Symbol	Inches		Millimeters	
	Min	Max	Min	Max
A	.190	.200	4.83	5.08
A ₁	.035	.045	0.89	1.14
A ₂	.120 BSC		3.05 BSC	
φb	.025	.035	0.64	0.89
D	.645	.665	16.38	16.89
D ₁	.410	.430	10.41	10.92
D ₃	.000	.065	0.00	1.65
e	.100 BSC		2.54 BSC	
E	.410	.422	10.41	10.71
L	.500	.750	12.70	19.05
O	.527	.537	13.39	13.64
φP	.140	.150	3.56	3.81

NOTES:

1. Dimensions shall be measured in inches.
2. Metric equivalents are given for general information only.
3. For case outlines T and U only, CAGE 34333, the ceramic seal that protrudes from the seating plane is not to be considered in overall package dimensions. The ceramic seal protrusion is considered uncontrolled within an area 30 mils from the seating plane.

FIGURE 1. Case outlines and terminal connections - Continued.

STANDARD MICROCIRCUIT DRAWING DEFENSE SUPPLY CENTER COLUMBUS COLUMBUS, OHIO 43218-3990	SIZE A		77034
		REVISION LEVEL X	SHEET 33

Case outline X

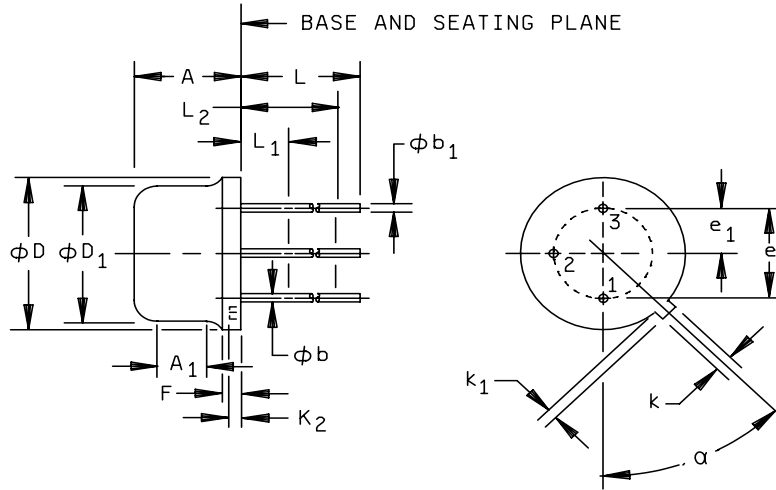

Device types 01, 02, 05, and 07

Device types 03, 04, 06, and 08

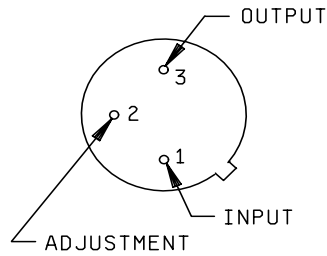

Bottom view

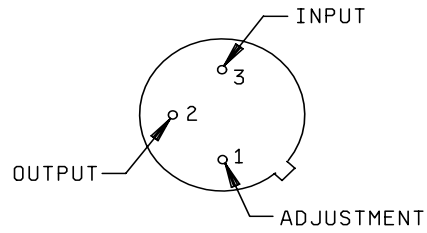

Bottom view

FIGURE 1. Case outlines and terminal connections - Continued.

STANDARD MICROCIRCUIT DRAWING DEFENSE SUPPLY CENTER COLUMBUS COLUMBUS, OHIO 43218-3990	SIZE A		77034
		REVISION LEVEL X	SHEET 34

Case outline X

Symbol	Inches		Millimeters		Notes
	Min	Max	Min	Max	
A	.165	.195	4.19	4.95	
A ₁	.100	---	2.54	---	7
φb	.016	.019	0.41	0.48	3
φb ₁	.016	.021	0.41	0.53	3
φD	.335	.370	8.51	9.40	
φD ₁	.305	.335	7.75	8.51	
e	.200 BSC		5.08 BSC		5
e ₁	.100 BSC		2.54 BSC		5
F	---	.050	---	1.27	
k	.028	.034	0.71	0.86	
k ₁	.029	.045	0.74	1.14	4
k ₂	.009	.041	0.23	1.04	
L	.500	---	12.70	---	
L ₁	---	.050	---	1.27	
L ₂	.250	---	6.35	---	
α	45° T.P.		45° T.P.		5

NOTES:

1. Dimensions shall be measured in inches.
2. Metric equivalents are given for general information only.
3. φb applies between L₁ and beyond .500 inch (12.70 mm) from the seating plane (two leads). Diameter is uncontrolled in L₁ and beyond .500 inch (12.70 mm) from the seating plane.
4. Two leads.
5. Two holes.
6. Two holes located at true position within diameter .010 inch (0.25 mm).
7. Leads having a maximum diameter of .043 inch (1.09 mm) measured in gauging plane .054 inch (1.37 mm) ± .001 (0.03 mm) .000 inch (0.00 mm) below the seating plane shall be located at true position within diameter .014 inch (0.36 mm).
8. The mounting surface of the header shall be flat to convex within .003 inch (0.08 mm) inside a .930 inch (23.62 mm) diameter circle on the center of the header and flat to convex within .006 inch (0.15 mm) overall.

FIGURE 1. Case outlines and terminal connections – Continued.

STANDARD MICROCIRCUIT DRAWING DEFENSE SUPPLY CENTER COLUMBUS COLUMBUS, OHIO 43218-3990	SIZE A		77034
		REVISION LEVEL X	SHEET 35

Case outline Y

Device types 01, 02, 05, and 07

Device types 03, 04, 06, and 08

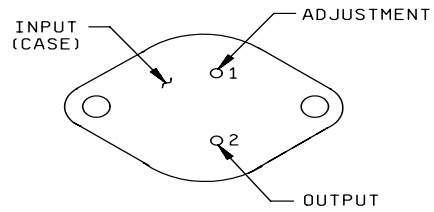
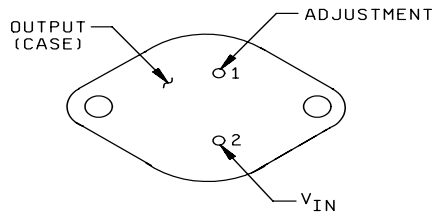

Bottom view

Bottom view

FIGURE 1. Case outlines and terminal connections – Continued.

STANDARD MICROCIRCUIT DRAWING DEFENSE SUPPLY CENTER COLUMBUS COLUMBUS, OHIO 43218-3990	SIZE A		77034
		REVISION LEVEL X	SHEET 36

Case outline Z

Device types 03, 04, 06, and 08

Device types 01, 02, 05, and 07

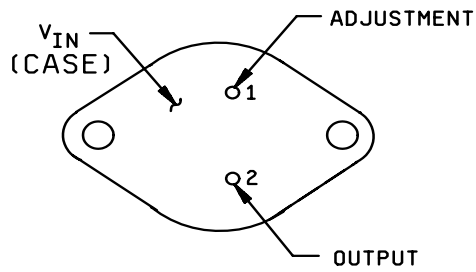

Bottom view

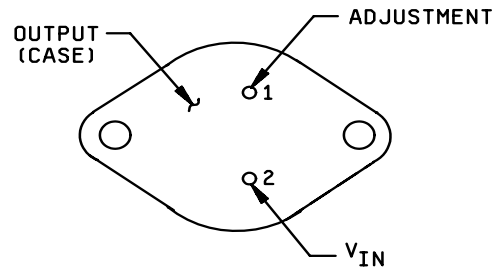

Bottom view

FIGURE 1. Case outlines and terminal connections – Continued.

STANDARD MICROCIRCUIT DRAWING DEFENSE SUPPLY CENTER COLUMBUS COLUMBUS, OHIO 43218-3990	SIZE A		77034
		REVISION LEVEL X	SHEET 37

Case outline 4

Device type	07
Terminal number	Terminal symbol
1	ADJUST
2	V_{OUT}
3	V_{IN}

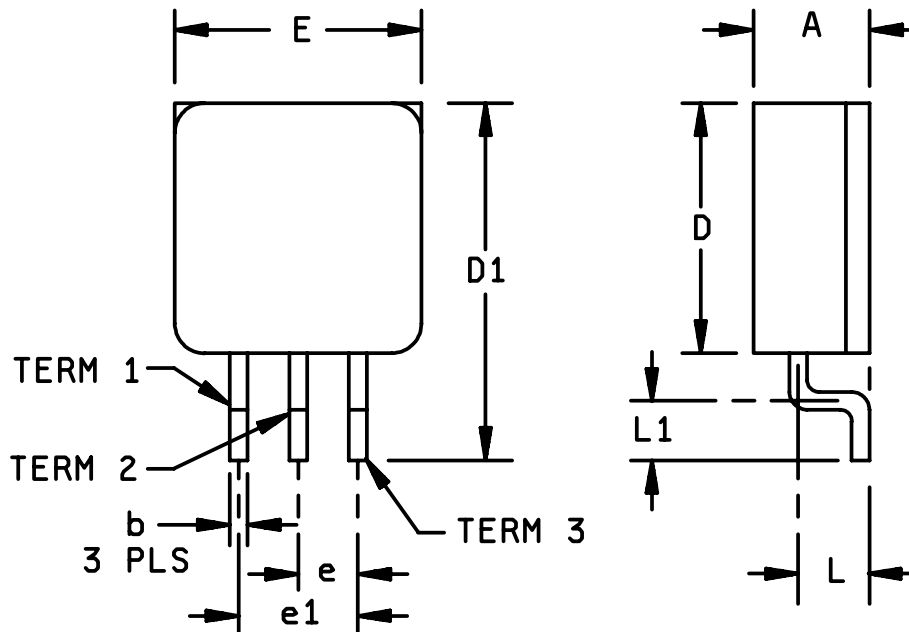

Symbol	Inches		Millimeters	
	Min	Max	Min	Max
A	.190	.210	4.83	5.33
b	---	.030	---	0.76
D	.410	.430	10.41	10.92
D1	.580	.610	14.73	15.49
e	---	.100	---	2.54
e1	---	.200	---	5.08
E	.410	.420	10.41	10.67
L1	.090	.110	2.29	2.79
L	.115	.125	2.92	3.18
N	3		3	

NOTE:

The U.S. government preferred system of measurement is the metric SI system. However, since this item was originally designed using inch-pound units of measurement, in the event of conflict between the metric and inch-pound units, the inch-pound units shall take precedence.

FIGURE 1. Case outlines and terminal connections – Continued.

STANDARD MICROCIRCUIT DRAWING DEFENSE SUPPLY CENTER COLUMBUS COLUMBUS, OHIO 43218-3990	SIZE A		77034
		REVISION LEVEL X	SHEET 38

Case outline 5

Device types 01, 02, 05, 07

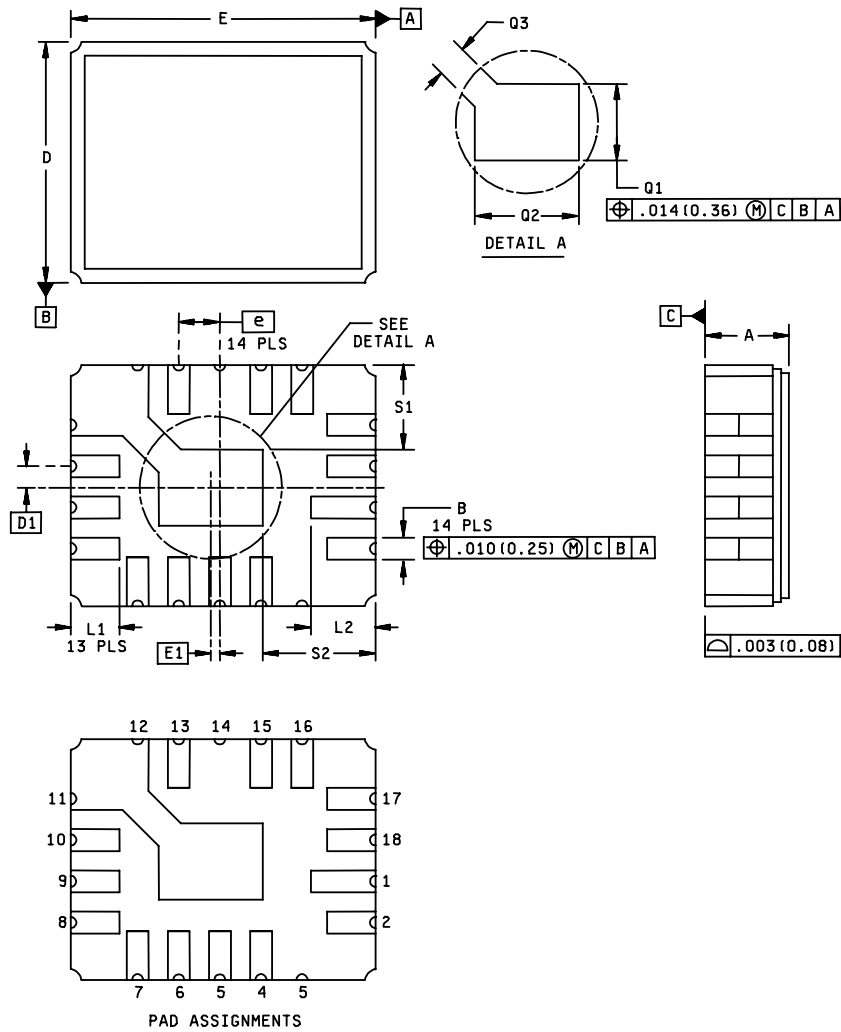

NOTES:

1. Dimensions are in inches. Metric equivalents are given for information only.
2. Pins 4, 5 - Adjust
- Pins 6, 7, 8, 9, 10, 11, 12, 13 - V_{IN}
- Pins 1, 2, 15, 16, 17, 18 - V_{OUT}
- Pins 3, 14 - no connect

FIGURE 1. Case outlines and terminal connections – Continued.

STANDARD MICROCIRCUIT DRAWING DEFENSE SUPPLY CENTER COLUMBUS COLUMBUS, OHIO 43218-3990	SIZE A		77034
		REVISION LEVEL X	SHEET 39

Case outline 6

Device types 03, 04, 06, 08

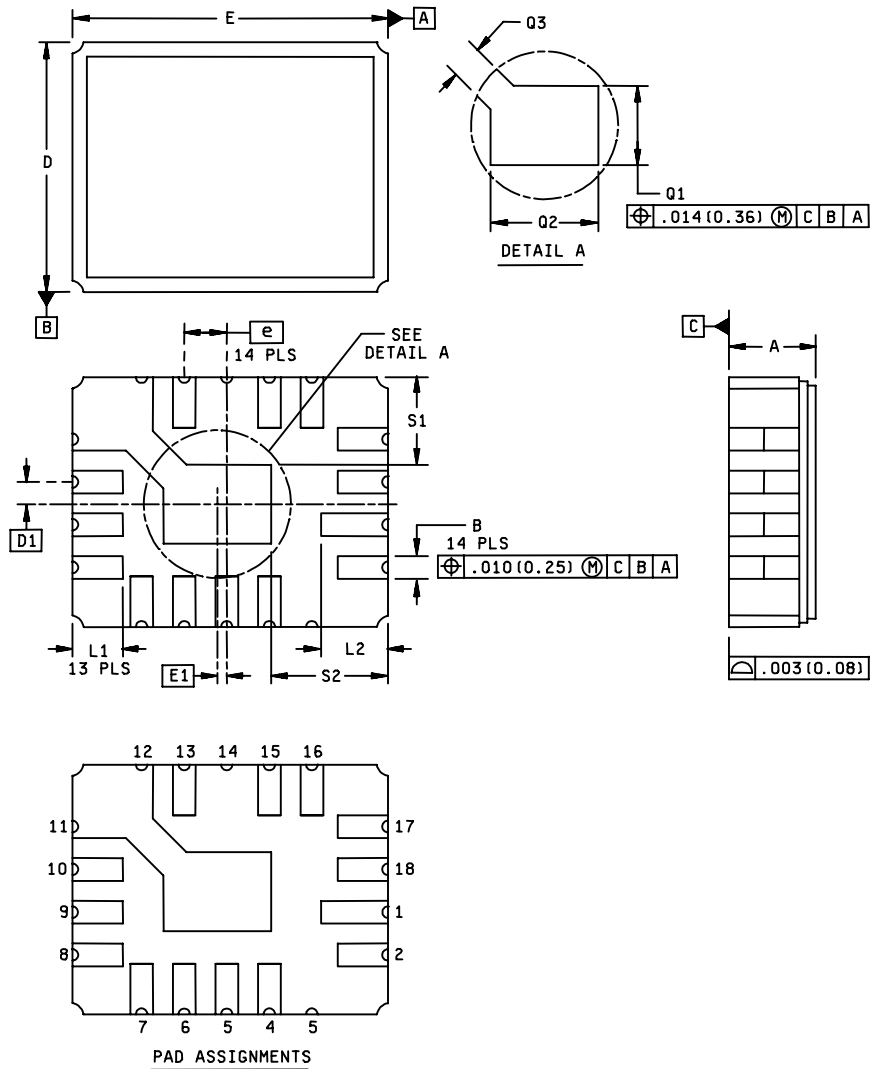

NOTES:

1. Dimensions are in inches. Metric equivalents are given for information only.
2. Pins 4, 5 - Adjust
Pins 6, 7, 8, 9, 10, 11, 12, 13 - V_{OUT}
Pins 1, 2, 15, 16, 17, 18 - V_{IN}
Pins 3, 14 - no connect

FIGURE 1. Case outlines and terminal connections – Continued.

STANDARD MICROCIRCUIT DRAWING DEFENSE SUPPLY CENTER COLUMBUS COLUMBUS, OHIO 43218-3990	SIZE A		77034
		REVISION LEVEL X	SHEET 40

Case outlines 5 and 6

Symbol	Inches		Millimeters	
	Min	Max	Min	Max
A	.095	.115	2.42	2.92
B	.020	.030	0.51	0.76
D	.280	.295	7.12	7.49
D1	.025 BSC		0.635 BSC	
E	.345	.360	8.77	9.14
E1	.008 BSC		0.203 BSC	
e	.050 BSC		1.27 BSC	
L1	.040	.055	1.02	1.39
L2	.055	.065	1.40	1.65
Q1	.070	.080	1.78	2.03
Q2	.120	.130	3.05	3.30
Q3	.045	.055	1.15	1.39
S1	.105 REF		2.67 REF	
S2	.120 REF		3.05 REF	

FIGURE 1. Case outlines and terminal connections – Continued.

STANDARD MICROCIRCUIT DRAWING DEFENSE SUPPLY CENTER COLUMBUS COLUMBUS, OHIO 43218-3990	SIZE A		77034
		REVISION LEVEL X	SHEET 41

Device types	01, 05	02, 07	03, 06	04, 08
Case outline	2			
Terminal number	Terminal symbol			
1	V_{OUT} SENSE (see note)	NC	V_{OUT}	V_{IN}
2	NC	NC	V_{OUT} SENSE (see note)	NC
3	NC	NC	NC	NC
4	NC	NC	NC	NC
5	V_{IN}	NC	NC	NC
6	NC	NC	NC	NC
7	NC	NC	NC	NC
8	NC	NC	NC	NC
9	NC	NC	NC	ADJUST
10	ADJUST	NC	NC	NC
11	NC	V_{IN}	V_{IN}	NC
12	NC	V_{OUT}	NC	V_{OUT}
13	NC	V_{OUT}	NC	V_{OUT}
14	NC	V_{OUT} SENSE (see note)	NC	NC
15	NC	NC	NC	NC
16	NC	NC	ADJUST	NC
17	NC	NC	NC	NC
18	NC	ADJUST	NC	NC
19	NC	NC	NC	NC
20	V_{OUT}	V_{IN}	NC	V_{IN}

NOTE: For normal operation, the V_{OUT} SENSE pin must be connected externally to the load.

FIGURE 1. Case outlines and terminal connections – Continued.

STANDARD MICROCIRCUIT DRAWING DEFENSE SUPPLY CENTER COLUMBUS COLUMBUS, OHIO 43218-3990	SIZE A		77034
		REVISION LEVEL X	SHEET 42

4. VERIFICATION

4.1 Sampling and inspection. For device classes Q and V, sampling and inspection procedures shall be in accordance with MIL-PRF-38535 or as modified in the device manufacturer's Quality Management (QM) plan. The modification in the QM plan shall not affect the form, fit, or function as described herein. For device class M, sampling and inspection procedures shall be in accordance with MIL-PRF-38535, appendix A.

4.2 Screening. For device classes Q and V, screening shall be in accordance with MIL-PRF-38535, and shall be conducted on all devices prior to qualification and technology conformance inspection. For device class M, screening shall be in accordance with method 5004 of MIL-STD-883, and shall be conducted on all devices prior to quality conformance inspection.

4.2.1 Additional criteria for device class M.

- a. Burn-in test, method 1015 of MIL-STD-883.
 - (1) Test condition A, B, C, or D. The test circuit shall be maintained by the manufacturer under document revision level control and shall be made available to the preparing or acquiring activity upon request. The test circuit shall specify the inputs, outputs, biases, and power dissipation, as applicable, in accordance with the intent specified in method 1015.
 - (2) $T_A = +125^{\circ}\text{C}$, minimum.
- b. Interim and final electrical test parameters shall be as specified in table IIA herein.

4.2.2 Additional criteria for device classes Q and V.

- a. The burn-in test duration, test condition and test temperature, or approved alternatives shall be as specified in the device manufacturer's QM plan in accordance with MIL-PRF-38535. The burn-in test circuit shall be maintained under document revision level control of the device manufacturer's Technology Review Board (TRB) in accordance with MIL-PRF-38535 and shall be made available to the acquiring or preparing activity upon request. The test circuit shall specify the inputs, outputs, biases, and power dissipation, as applicable, in accordance with the intent specified in method 1015 of MIL-STD-883.
- b. Interim and final electrical test parameters shall be as specified in table IIA herein.
- c. Additional screening for device class V beyond the requirements of device class Q shall be as specified in MIL-PRF-38535, appendix B.

4.3 Qualification inspection for device classes Q and V. Qualification inspection for device classes Q and V shall be in accordance with MIL-PRF-38535. Inspections to be performed shall be those specified in MIL-PRF-38535 and herein for groups A, B, C, D, and E inspections (see 4.4.1 through 4.4.4).

4.4 Conformance inspection. Technology conformance inspection for classes Q and V shall be in accordance with MIL-PRF-38535 including groups A, B, C, D, and E inspections and as specified. Quality conformance inspection for device class M shall be in accordance with MIL-PRF-38535, appendix A and as specified herein. Inspections to be performed for device class M shall be those specified in method 5005 of MIL-STD-883 and herein for groups A, B, C, D, and E inspections (see 4.4.1 through 4.4.4).

4.4.1 Group A inspection.

- a. Tests shall be as specified in table IIA herein.
- b. Subgroups 7, 8, 9, 10, and 11 in table I, method 5005 of MIL-STD-883 shall be omitted.

STANDARD MICROCIRCUIT DRAWING DEFENSE SUPPLY CENTER COLUMBUS COLUMBUS, OHIO 43218-3990	SIZE A		77034
		REVISION LEVEL X	SHEET 43

TABLE IIA. Electrical test requirements.

Test requirements	Subgroups (in accordance with MIL-STD-883, method 5005, table I)	Subgroups (in accordance with MIL-PRF-38535, table III)	
	Device class M	Device class Q	Device class V
Interim electrical parameters (see 4.2)	---	---	---
Final electrical parameters (see 4.2)	1,2,3,4,5,6 <u>1/ 2/</u>	1,2,3,4,5,6 <u>1/ 2/</u>	1,2,3,4,5,6 <u>1/ 2/</u>
Group A test requirements (see 4.4)	1,2,3	1,2,3	1,2,3
Group C end-point electrical parameters (see 4.4)	1	1	1,2,3 <u>3/</u>
Group D end-point electrical parameters (see 4.4)	1	1	1,2,3
Group E end-point electrical parameters (see 4.4)	1	1	1

1/ PDA applies to subgroup 1.

2/ Subgroups 4, 5, and 6, if not tested, shall be guaranteed to the limits specified in table I.

3/ Delta limits as specified in table IIB shall be required where specified and the delta limits shall be computed with reference to the previous end-point electrical parameter

TABLE IIB. Group C delta limits at +25°C.

Test	Device type	Case outline	Limit		Unit
			Min	Max	
V _{REF}	03,04	X, Y		±0.01	V
R _{LINE}	03,04	X, Y		±4	mV
I _{ADJ}	03	X, Y		±10	µA
	04	X, Y		±10	

4.4.2 Group C inspection. The group C inspection end-point electrical parameters shall be as specified in table IIA herein.

4.4.2.1 Additional criteria for device class M. Steady-state life test conditions, method 1005 of MIL-STD-883:

- a. Test condition A, B, C, or D. The test circuit shall be maintained by the manufacturer under document revision level control and shall be made available to the preparing or acquiring activity upon request. The test circuit shall specify the inputs, outputs, biases, and power dissipation, as applicable, in accordance with the intent specified in method 1005 of MIL-STD-883.
- b. T_A = +125°C, minimum.
- c. Test duration: 1,000 hours, except as permitted by method 1005 of MIL-STD-883.

4.4.2.2 Additional criteria for device classes Q and V. The steady-state life test duration, test condition and test temperature, or approved alternatives shall be as specified in the device manufacturer's QM plan in accordance with MIL-PRF-38535. The test circuit shall be maintained under document revision level control by the device manufacturer's TRB in accordance with MIL-PRF-38535 and shall be made available to the acquiring or preparing activity upon request. The test circuit shall specify the inputs, outputs, biases, and power dissipation, as applicable, in accordance with the intent specified in test method 1005 of MIL-STD-883.

STANDARD MICROCIRCUIT DRAWING DEFENSE SUPPLY CENTER COLUMBUS COLUMBUS, OHIO 43218-3990	SIZE A		77034
		REVISION LEVEL X	SHEET 44

4.4.3 Group D inspection. The group D inspection end-point electrical parameters shall be as specified in table IIA herein.

4.4.4 Group E inspection. Group E inspection is required only for parts intended to be marked as radiation hardness assured (see 3.5 herein). RHA levels for device classes M, Q, and V shall be as specified in MIL-PRF-38535. End-point parameters shall be as specified in table IIA herein.

4.4.4.1 Total dose irradiation testing. Total dose irradiation testing shall be performed in accordance with MIL-STD-883 method 1019, condition A and as specified herein.

5. PACKAGING

5.1 Packaging requirements. The requirements for packaging shall be in accordance with MIL-PRF-38535 for device classes Q and V or MIL-PRF-38535, appendix A for device class M.

6. NOTES

6.1 Intended use. Microcircuits conforming to this drawing are intended for use for Government microcircuit applications (original equipment), design applications, and logistics purposes.

6.1.1 Replaceability. Microcircuits covered by this drawing will replace the same generic device covered by a contractor-prepared specification or drawing.

6.2 Configuration control of SMD's. All proposed changes to existing SMD's will be coordinated with the users of record for the individual documents. This coordination will be accomplished using DD Form 1692, Engineering Change Proposal.

6.3 Record of users. Military and industrial users should inform Defense Supply Center Columbus (DSCC) when a system application requires configuration control and which SMD's are applicable to that system. DSCC will maintain a record of users and this list will be used for coordination and distribution of changes to the drawings. Users of drawings covering microelectronic devices (FSC 5962) should contact DSCC-VA, telephone (614) 692-0544.

6.4 Comments. Comments on this drawing should be directed to DSCC-VA, Columbus, Ohio 43218-3990, or telephone (614) 692-0547.

6.5 Abbreviations, symbols, and definitions. The abbreviations, symbols, and definitions used herein are defined in MIL-PRF-38535 and MIL-HDBK-1331.

6.6 Sources of supply.

6.6.1 Sources of supply for device classes Q and V. Sources of supply for device classes Q and V are listed in QML-38535. The vendors listed in QML-38535 have submitted a certificate of compliance (see 3.6 herein) to DSCC-VA and have agreed to this drawing.

6.6.2 Approved sources of supply for device class M. Approved sources of supply for class M are listed in MIL-HDBK-103. The vendors listed in MIL-HDBK-103 have agreed to this drawing and a certificate of compliance (see 3.6 herein) has been submitted to and accepted by DSCC-VA.

STANDARD MICROCIRCUIT DRAWING DEFENSE SUPPLY CENTER COLUMBUS COLUMBUS, OHIO 43218-3990	SIZE A		77034
		REVISION LEVEL X	SHEET 45

STANDARD MICROCIRCUIT DRAWING BULLETIN

DATE: 06-01-30

Approved sources of supply for SMD 77034 are listed below for immediate acquisition information only and shall be added to MIL-HDBK-103 and QML-38535 during the next revision. MIL-HDBK-103 and QML-38535 will be revised to include the addition or deletion of sources. The vendors listed below have agreed to this drawing and a certificate of compliance has been submitted to and accepted by DSCC-VA. This information bulletin is superseded by the next dated revision of MIL-HDBK-103 and QML-38535. DSCC maintains an online database of all current sources of supply at <http://www.dscclia.mil/Programs/Smcr/>.

Standard microcircuit drawing PIN 1/	Vendor CAGE number	Vendor similar PIN 2/	Reference military specification PIN
7703401MA	21845	SDP117MMD	
	69210	OM1320SMM	
7703401NA	21845	SDP117NMD	
	69210	OM1320NMM	
7703401TA	U3158	IP117G-DESC	
	21845	SDP117TMD	
	69210	OM1320NTM	
	34333	SG117G/883B	
7703401UA	U3158	IP117G-DESC	
	21845	SDP117UMD	
	3/	FM117S7/883	
	34333	SG117G/883B	
	69210	OM1320STM	
7703401XA	U3158	IP117MH-DESC	M38510/11703BXX
	3/	LM117H/883B	
	34333	SG117T/883B	
	3/	LM117H/883B	
	21845	SDP117XMD	
7703401YA	U3158	IP117K-DESC	M38510/11704BYX
	3/	LM117K/883	
	34333	SG117K/883B	
	3/	LM117K/883B	
	69210	OM1320NKM	
7703401ZA	U3158	IP117R-DESC	
	34333	SG117R/883B	
77034012A	3/	UC117L/883BC	
	21845	SDP1172MD	
	34333	SG117L/883B	
	69210	OM1320N2M	
77034015A	U3158	IP117E	
7703402MA	21845	SDP117HVMMD	
	69210	OM1321SMM	
7703402NA	21845	SDP117HVNMD	
	69210	OM1321NMM	
7703402TA	U3158	IP117HVG-DESC	
	21845	SDP117HVTMD	
	69210	OM1321STM	
7703402UA	U3158	IP117HVG-DESC	
	21845	SDP117HVUMD	
	3/	FM117HVS7/883	
	69210	OM1321NTM	
7703402XA	U3158	IP117MHVH-DESC	
	3/	LM117HVH/883B	
	69210	OM1321NHM	
	21845	SDP117HVXMD	

See footnotes at end of table.

STANDARD MICROCIRCUIT DRAWING BULLETIN - Continued

Standard microcircuit drawing PIN 1/	Vendor CAGE number	Vendor similar PIN 2/	Reference military specification PIN
7703402YA	U3158	IP117HVK-DESC	
	<u>3/</u>	LM117HVK/883	
	<u>3/</u>	LM117HVK/883B	
	69210	OM1321NKM	
	21845	SDP117HVYMD	
7703402ZA	U3158	IP117HVR-DESC	
77034022A	21845	SDP117HV2MD	
	69210	OM1321N2M	
77034025A	U3158	IP117HVE	
7703403MA	21845	SDP137MMD	
	69210	OM1322SMM	
7703403NA	21845	SDP137NMD	
	69210	OM1322NMM	
7703403TA	U3158	IP137G-DESC	
	21845	SDP137TMD	
	69210	OM1322NTM	
7703403UA	U3158	IP137IG-DESC	
	21845	SDP137UMD	
	<u>3/</u>	FM137S7/883	
	<u>3/</u>	SG137IG/883B	
	69210	OM1322STM	
7703403XA	U3158	IP137MH-DESC	M38510/11803BXX
	27014	LM137H/883B	
	34333	SG137T/883B	
	<u>3/</u>	LM137H/883B	
	21845	SDP137XMD	
7703403YA	U3158	IP137K-DESC	M38510/11804BYX
	27014	LM137K/883B	
	<u>3/</u>	SG137K/883B	
	<u>3/</u>	LM137K-883B	
	69210	OM1322NKM	
	21845	SDP137YMD	
7703403ZA	U3158	IP137R-DESC	
	<u>3/</u>	SG137R/883B	
77034032A	21845	SDP1372MD	
	34333	SG137L/883B	
	69210	OM1322N2M	
77034036A	U3158	IP137E	
7703404MA	21845	SDP137HVMMMD	
	69210	OM1323SMM	
7703404NA	21845	SDP137HVNMD	
	69210	OM1323NMM	
7703404TA	U3158	IP137HVG-DESC	
	21845	SDP137HVTMD	
	69210	OM1323NTM	
7703404UA	U3158	IP137HVIG-DESC	
	21845	SDP137HVUMD	
	<u>3/</u>	FM137HV/883	
	69210	OM1323STM	
7703404XA	U3158	IP137HVH-DESC	
	27014	LM137HVH/883	
	<u>3/</u>	LM137HVH/883	
	21845	SDP137HVXMD	
7703404YA	U3158	IP137HVK-DESC	
	27014	LM137HVK/883	
	<u>3/</u>	LM137HVK/883B	
	69210	OM1323NKM	
	21845	SDP137HVYMD	

See footnotes at end of table.

STANDARD MICROCIRCUIT DRAWING BULLETIN - Continued

Standard microcircuit drawing PIN 1/	Vendor CAGE number	Vendor similar PIN 2/	Reference military specification PIN
7703404ZA	U3158	IP137HVR-DESC	
77034042A	21845	SDP137HV2MD	
	69210	OM1323N2M	
77034046A	U3158	IP137HVE	
7703405MA	3/	SDP117AMMD	
	69210	OM1324SMM	
7703405NA	3/	SDP117ANMD	
	69210	OM1324NMM	
7703405TA	U3158	IP117AG-DESC	
	3/	SDP117ATMD	
	69210	OM1324NTM	
7703405UA	34333	SG117AG/883B	
	U3158	IP117AIG-DESC	
	3/	SDP117AUMD	
	3/	FM117AS7	
7703405XA	34333	SG117AIG/883B	
	69210	OM1324STM	
	U3158	IP117MAH-DESC	
	34333	SG117AT/883B	
7703405YA	3/	LT117AH/883B	
	3/	SDP117AXMD	
	U3158	IP117AK-DESC	
	34333	SG117AK/883B	
7703405ZA	3/	LT117AK/883B	
	69210	OM1324NKM	
	3/	SDP117AYMD	
	U3158	IP117AR-DESC	
77034052A	34333	SG117AR/883B	
	3/	UC117AL/883BC	
	3/	SDP117A2MD	
	69210	OM1324N2M	
77034055A	U3158	IP117AE	
7703406MA	21845	SDP137AMMD	
	69210	OM1325SMM	
7703406NA	21845	SDP137ANMD	
	69210	OM1325NMM	
7703406TA	U3158	IP137AG-DESC	
	21845	SDP137ATMD	
	69210	OM1325NTM	
7703406UA	U3158	IP137AIG-DESC	
	21845	SDP137AUMD	
	3/	FM137AS7	
	3/	SG137AIG/883B	
7703406XA	69210	OM1325STM	
	U3158	IP137AH-DESC	
	34333	SG137AT/883B	
	3/	LT137AH/883B	
7703406YA	21845	SDP137AXMD	
	U3158	IP137AK-DESC	
	3/	SG137AK/883B	
	3/	LT137AK/883B	
7703406YA	69210	OM1325NKM	
	21845	SDP137AYMD	
	21845	SDP137AYMD	

See footnotes at end of table.

STANDARD MICROCIRCUIT DRAWING BULLETIN - Continued

Standard microcircuit drawing PIN 1/	Vendor CAGE number	Vendor similar PIN 2/	Reference military specification PIN
7703406ZA	U3158	IP137AR-DESC	
	3/	SG137AR/883B	
77034062A	21845	SDP137A2MD	
	34333	SG137AL/883B	
	69210	OM1325N2M	
77034066A	U3158	IP137AE	
7703407MA	3/	SDP117AHVMMD	
	69210	OM1326SMM	
7703407NA	3/	SDP117AHVNMD	
	69210	OM1326NMM	
7703407TA	U3158	IP117AHVG-DESC	
	3/	SDP117AHVTMD	
	69210	OM1326NTM	
7703407UA	U3158	IP117AHVIG-DESC	
	3/	SDP117AHVUMD	
	3/	FM117AHVS7	
	69210	OM1326STM	
7703407XA	U3158	IP117MAHVH-DESC	
	3/	LT117AHVH/883B	
	69210	OM1326NHM	
	3/	SDP117AHVXMD	
7703407YA	U3158	IP117AHVK-DESC	
	3/	LT117AHVK/883B	
	69210	OM1326NKM	
	3/	SDP117AHVYMD	
7703407ZA	U3158	IP117AHVR-DESC	
77034072A	3/	SDP117AHV2MD	
	69210	OM1326N2M	
77034074A	69210	OM1326SRM	
77034075A	U3158	IP117AHVE	
7703408MA	3/	SDP137AHVMMD	
	69210	OM1327SMM	
7703408NA	3/	SDP137AHVNMD	
	69210	OM1327NMM	
7703408TA	U3158	IP137AHVG-DESC	
	3/	SDP137AHVTMD	
	69210	OM1327NTM	
7703408UA	U3158	IP137AHVIG-DESC	
	3/	SDP137AHVUMD	
	3/	FM137AHV/883	
	69210	OM1327STM	
7703408XA	U3158	IP137AHVH-DESC	
	3/	LT137AHVH/883B	
	3/	SDP137AHVXMD	
7703408YA	U3158	IP137AHVK-DESC	
	3/	LT137AHVK/883B	
	69210	OM1327NKM	
	3/	SDP137AHVYMD	
7703408ZA	U3158	IP137AHVR-DESC	
77034082A	3/	SDP137AHV2MD	
	69210	OM1327N2M	
77034086A	U3158	IP137AHVE	

See footnotes at end of table.

STANDARD MICROCIRCUIT DRAWING BULLETIN - Continued

Standard microcircuit drawing PIN 1/	Vendor CAGE number	Vendor similar PIN 2/	Reference military specification PIN
5962-7703404VXA	3/	LM137HVH-QMLV	
5962-7703404VYA	3/	LM137HVK-QMLV	
5962R7703402MUA	3/	OMR1321STM/883B	
5962R7703407MUA	3/	OMR1326STM/883B	

- 1/ The lead finish shown for each PIN representing a hermetic package is the most readily available from the manufacturer listed for that part. If the desired lead finish is not listed contact the vendor to determine its availability.
- 2/ Caution. Do not use this number for item acquisition. Items acquired to this number may not satisfy the performance requirements of this drawing.
- 3/ Not available from an approved source of supply.

<u>Vendor CAGE number</u>	<u>Vendor name and address</u>
U3158	SEMELAB PLC Coventry Road, Lutterworth, Leicestershire LE174JB United Kingdom
21845	Solitron Devices, Incorporated 3301 Electronics Way West Palm Beach, FL 33407-4697
27014	National Semiconductor 2900 Semiconductor Drive P.O. Box 58090 Santa Clara, CA 95052-8090
34333	Microsemi Integrated Products 11861 Western Avenue Garden Grove, CA 92841-2119
69210	International Rectifier 205 Crawford Street Leominster, MA 01453-2353

The information contained herein is disseminated for convenience only and the Government assumes no liability whatsoever for any inaccuracies in the information bulletin.