

Tantalum Capacitor (SCS Series)



The product is smaller version of the SCN series products.

The SCS series have fully molded, compliant lead frame construction designed for use in applications utilizing solder (Reflow, Wave or Vapor Phase), conductive adhesive or thermal compression bonding techniques.

General Features

Miniaturized tantalum chip capacitors with extended capacitance.

(Reduced size 1/2 to 1/3 in comparison with SCN.)

- Molded Case available in five case codes.
- Compatible with automatic pick and place equipment.
- Meets or Exceeds EIA standard 535BAAC .
- Extended Range Values

Applications

- General electronic equipment
- Smoothing Circuit of DC-DC Converters & Output side of AC-DC Converters
- De-Coupling Circuit of High Speed ICs & MPUs
- Various Other High Frequency Circuit Applications

Part Numbering

TC	SCS	0J	106	M	B	A	R	0
①	②	③	④	⑤	⑥	⑦	⑧	

① Abbreviation of Tantalum Capacitor

② Type of Series

③ Rated Voltage

④ Capacitance Tolerance

⑤ Capacitance Tolerance

⑥ Case size

⑦ Packing

⑧ Packing Polarity

① ABBREVIATION OF TANTALUM CAPACITOR

② TYPE OF SERIES

The symbol shows the type of the capacitor.

SCS : Samsung environmental Capacitor Standard series

③ RATED VOLTAGE

Symbol	DC Rated Voltage	Symbol	DC Rated Voltage
0E	2.5	1C	16
0G	4	1D	20
0J	6.3	1E	25
1A	10	1V	35

④ CAPACITANCE

Symbol	Capacitance (μF)	Pico Farad (pF)	Symbol	Capacitance (μF)	PicoFarad (pF)
105	1.0	10×10^5	684	0.68	68×10^4
106	10.0	10×10^6	475	4.7	47×10^5

⑤ CAPACITANCE TOLERANCE

Symbol	Tolerance(%)	Symbol	Tolerance(%)
K	± 10	M	± 20

⑥ CASE SIZE

Case	EIA Code	Case	EIA Code
J	1608	C	6032
P	2012	D	7343
A	3216		
B	3528		

7 PACKING

Symbol	Packing Code
A	7 inch
C	13 inch

8 PACKING POLARITY

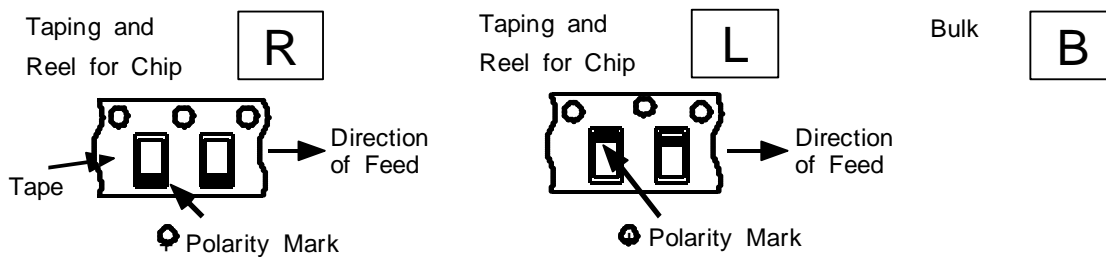

APPEARANCE AND DIMENSION

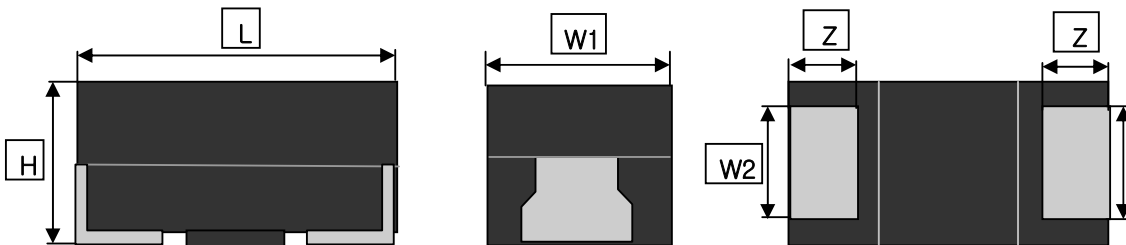

Code	EIA Code	DIMENSION (mm)				
		L	W ₁	W ₂	H	Z
P	2012	2.0 ±0.2	1.25 ±0.2	0.9 ±0.1	1.2 MAX	0.5 ±0.2
A	3216	3.2 ±0.2	1.6 ±0.2	1.2 ±0.1	1.6 ±0.2	0.8 ±0.3
B	3528	3.5 ±0.2	2.8 ±0.2	2.2 ±0.1	1.9 ±0.2	0.8 ±0.3
C	6032	6.0 ±0.3	3.2 ±0.3	2.2 ±0.1	2.5 ±0.3	1.3 ±0.3
D	7343	7.3 ±0.3	4.3 ±0.3	2.4 ±0.1	2.8 ±0.3	1.3 ±0.3

● Standard value and Case size

▶ SCS Series

Standard value and case size

Cap.(μ F) \ R . V	2.5V(0E)	4V(0G)	6.3V(0J)	10V(1A)	16V(1C)	20V(1D)	25V(1E)	35V(1V)
0.15	154							
0.22	224							
0.33	334							
0.47	474							A
0.68	684						A	A
1.0	105					A	A	A
1.5	155				A	A	A	A, B
2.2	225			A	A	A	A, B	B
3.3	335		A	A	A	A, B	A, B	B
4.7	475	A	A	A	A, B	A, B	B	C
6.8	685	A	A	A, B	A, B	B	B, C	C
10	106	A	A, B	A, B	A, B	B, C	B, C	C, D
15	156	A, B	A, B	A, B	B, C	C	C, D	C, D
22	226	A, B	A, B	A, B, C	B, C	B, C, D	C, D	D
33	336	A, B	A, B, C	A, B, C	B, C, D	C, D	D	D
47	476	A, B, C	A, B, C	B, C, D	C, D	D		
68	686	B, C	B, C, D	C, D	C, D	D		
100	107	A, B, C, D	B, C, D	(B), C, D	D	D		
150	157	C, D	C, D	D	D			
220	227	B	B, C, D	C, D	D			
330	337		D	D				
470	477		D	D				
680	687							

() : Under Development

▶ SCS-P Series

Standard value and case size

Cap.(μ F) \ R . V	4V(0G)	6.3V(0J)	10V(1A)	16V(1C)	20V(1D)
0.22	224	P	P	P	
0.33	334				
0.47	474	P	P	P	P
0.68	684	P	P	P	P
1.0	105	P	P	P	
1.5	155				
2.2	225	P	P	P	P
3.3	335	P	P	P	
4.7	475	P	P	P	
6.8	685	P	P		
10	106	P	P	P	
15	156				
22	226	P	P		
33	336		P	(P)	
47	476		(P)	(P)	
100	107	(P)	(P)		

() : Under Development

RELIABILITY TEST CONDITION

Reliability Test and Judgment Condition 1

Item	Performance	Test condition
Capacitance	Within specified tolerance	120Hz, maximum 1.0Vrms, maximum 1.5Volt D.C, at 25 °C
Tan δ (DF)	Within specified value	120Hz, maximum 1.0Vrms, maximum 1.5Volt D.C, at 25 °C
Impedance (Z) & ESR	Within specified value	100kHz, maximum 1.0Vrms, maximum 1.5Volt D.C, at 25 °C
Leakage current	0.01CV or 0.5 μ A whichever is greater	The rated DC voltage shall be applied to terminals across the test capacitor charge Time: 5 min.
Temperature Characteristics	"-55 °C : Δ C/C -10~0% "+85 °C : Δ C/C 0~10% "+125 °C : Δ C/C 0~15%	From -55 °C to 125 °C,
Surge withstanding Voltage	Capacitance change : within \pm 5 % Tan δ , LC : initial spec.	85 \pm 2 °C, Surge voltage Charge 30 \pm 5s -> Discharge 5.5 \pm 0.5min 1000cycle Charge discharge resister :33 Ω
Adhesion Strength	No peeling shall be occur on the terminal electrode	19.6N, for 5 \pm 1 sec
Electrode Strength	Within specified tolerance Tan δ , LC : initial spec.	Bending to the limit (3mm) with 1.0mm/sec.
Solderability	More than 95% of terminal surface is to be soldered newly	SnAg3.0Cu0.5 solder :245 \pm 5 °C, 3 \pm 0.3sec (preheating : 80~120 °C for 10~30sec.)
Resistance to Soldering heat	Capacitance change : within \pm 15% Tan δ , LC : initial spec.	Solder pot : 260 \pm 5 °C, 10 \pm 1 sec.
Vibration Test	Capacitance change : within \pm 5% Tan δ , LC : initial spec.	Amplitude : 1.5mm From 10Hz to 55Hz (return : 1min.) 2hours \times 3 direction (x, y, z)
Moisture Resistance	Capacitance change : within \pm 10% Tan δ , LC : initial spec.	40 \pm 2 °C, 90~95%RH, 500+8/-0hrs
High Temperature Resistance	Capacitance change : within \pm 10% Tan δ :initial spec LC : 125% or less specified initial value	With the rated voltage(85 °C) Max. operating temperature(125 °C) 2000/-0hrs
Storage at Low Temperature	Capacitance change : within \pm 10% Tan δ , LC : initial spec.	-55 \pm 2 °C, 240 \pm 8hrs
Temperature Cycling	Capacitance change : within \pm 5% Tan δ , LC : initial spec	1 cycle condition (Min. operating temperature \rightarrow 25 °C \rightarrow Max. operating temperature \rightarrow 25 °C) 5 cycle test

RELIABILITY TEST CONDITION

Reliability Test and Judgment Condition 2

Item	Performance	Test condition
Capacitance	Within specified tolerance	120Hz, maximum 1.0Vrms, maximum 1.5Volt D.C, at 25 °C
Tan δ (DF)	Within specified value	120Hz, maximum 1.0Vrms, maximum 1.5Volt D.C, at 25 °C
Impedance (Z) & ESR	Within specified value	100kHz, maximum 1.0Vrms, maximum 1.5Volt D.C, at 25 °C
Leakage current	0.01CV or 0.5μA whichever is greater	The rated DC voltage shall be applied to terminals across the test capacitor charge Time: 5 min.
Temperature Characteristics	"-55 °C : ΔC/C -25~0% "+85 °C : ΔC/C 0~20% "+125 °C : ΔC/C 0~20%	From -55 °C to 125 °C,
Surge withstanding Voltage	Capacitance change : within ±30% Tan δ :150% or less specified initial value LC : initial spec.	85±2 °C, Surge voltage Charge 30±5s → Discharge 5.5±0.5min 1000cycle Charge discharge resistor :33Ω
Adhesion Strength	No peeling shall be occur on the terminal electrode	19.6N, for 5±1 sec
Electrode Strength	Within specified tolerance Tan δ, LC : initial spec.	Bending to the limit (3mm) with 1.0mm/sec.
Solderability	More than 95% of terminal surface is to be soldered newly	SnAg3.0Cu0.5 solder :245+/-5 °C, 3±0.3sec (preheating : 80~120 °C for 10~30sec.)
Resistance to Soldering heat	Capacitance change : within ±30% Tan δ :150% or less specified initial value LC : 200% or less specified initial value	Solder pot : 260±5 °C, 10±1sec.
Vibration Test	Capacitance change : within ±15% Tan δ, LC : initial spec.	Amplitude : 1.5mm From 10Hz to 55Hz (return : 1min.) 2hours ´ 3 direction (x, y, z)
Moisture Resistance	Capacitance change : within ±30% Tan δ :150% or less specified initial value LC : 200% or less specified initial value	40±2 °C, 90~95%RH, 500+8/-0hrs
High Temperature Resistance	Capacitance change : within ±30% Tan δ :150% or less specified initial value LC : 125% or less specified initial value	With the rated voltage(85 °C) Max. operating temperature(125 °C) 2000/-0hrs
Storage at Low Temperature	Capacitance change : within ±30% Tan δ :150% or less specified initial value LC : initial spec.	-55±2 °C, 240±8hrs
Temperature Cycling	Capacitance change : within ±30% Tan δ :150% or less specified initial value LC : 200% or less specified initial value	1 cycle condition (Min. operating temperature → 25 °C → Max. operating temperature → 25 °C) 5 cycle test

RELIABILITY TEST CONDITION

Reliability Test and Judgment Condition 3

Item	Performance	Test condition
Capacitance	Within specified tolerance	120Hz, maximum 1.0Vrms, maximum 1.5Volt D.C, at 25 °C
Tan δ (DF)	Within specified value	120Hz, maximum 1.0Vrms, maximum 1.5Volt D.C, at 25 °C
Impedance (Z) & ESR	Within specified value	100kHz, maximum 1.0Vrms, maximum 1.5Volt D.C, at 25 °C
Leakage current	0.01CV or 0.5 μ A whichever is greater	The rated DC voltage shall be applied to terminals across the test capacitor charge Time: 5 min.
Temperature Characteristics	"-55 °C : Δ C/C -15~0% "+85 °C : Δ C/C 0~15% "+125 °C : Δ C/C 0~20%	From -55 °C to 125 °C,
Surge withstanding Voltage	Capacitance change : within \pm 5 % Tan δ , LC : initial spec.	85 \pm 2 °C, Surge voltage Charge 30 \pm 5s -> Discharge 5.5 \pm 0.5min 1000cycle Charge discharge resister :33 Ω
Adhesion Strength	No peeling shall be occur on the terminal electrode	19.6N, for 5 \pm 1 sec
Electrode Strength	Within specified tolerance Tan δ , LC : initial spec.	Bending to the limit (3mm) with 1.0mm/sec.
Solderability	More than 95% of terminal surface is to be soldered newly	SnAg3.0Cu0.5 solder :245 \pm 5 °C, 3 \pm 0.3sec (preheating : 80~120 °C for 10~30sec.)
Resistance to Soldering heat	Capacitance change : within \pm 15% Tan δ , LC : initial spec.	Solder pot : 260 \pm 5 °C, 10 \pm 1sec.
Vibration Test	Capacitance change : within \pm 5% Tan δ , LC : initial spec.	Amplitude : 1.5mm From 10Hz to 55Hz (return : 1min.) 2hours ´ 3 direction (x, y, z)
Moisture Resistance	Capacitance change : within \pm 10% Tan δ , LC : initial spec.	40 \pm 2 °C, 90~95%RH, 500+8/-0hrs
High Temperature Resistance	Capacitance change : within \pm 10% Tan δ :initial spec LC : 125% or less specified initial value	With the rated voltage(85 °C) Max. operating temperature(125 °C) 2000/-0hrs
Storage at Low Temperature	Capacitance change : within \pm 10% Tan δ , LC : initial spec.	-55 \pm 2 °C, 240 \pm 8hrs
Temperature Cycling	Capacitance change : within \pm 5% Tan δ , LC : initial spec	1 cycle condition (Min. operating temperature \rightarrow 25 °C \rightarrow Max. operating temperature \rightarrow 25 °C) 5 cycle test

RELIABILITY TEST CONDITION

Table 1 : Maximum Dissipation Factor at Specified Temperatures

Maximum Dissipation Factor, %			
-55 °C (%)	+25 °C (%)	+85 °C (%)	+125 °C (%)
9	4	7	9
10	6	8	10
12	8	10	12
15	10	13	15
17	12	15	17
27	18	27	36
30	20	30	40
45	30	45	60

Table 2 : Maximum DC Leakage Current at Specified Temperatures

Maximum DC Leakage Current, μA			
Specified initial value	-55 °C (μA)	+85 °C (μA)	+125 °C (μA)
0.01CV or 0.5 μA whichever is greater	-	0.1CV or 5 μA whichever is greater	0.125CV or 6.25 μA whichever is greater

PACKAGING

● MARKING

▶ P,R CASES

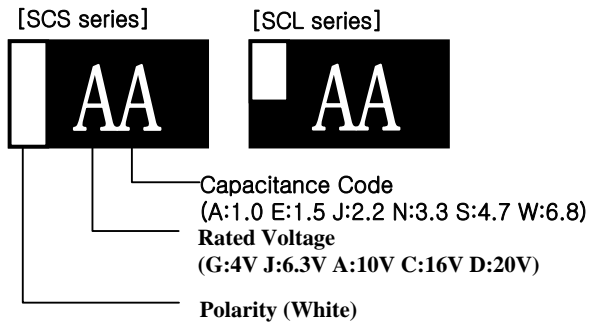

Capacitance Range	1 DIGIT	2 DIGIT
$< 1.0 \mu F$	A Small Letter	A Small Letter
$1.0 \mu F \leq \text{Cap.} < 10 \mu F$	A Capital Letter	A Small Letter
$\geq 10 \mu F$	A Capital Letter	A Capital Letter

【Code Reference】

$\mu F \backslash V$	4	6.3	10	16	20
0.22	gj	jj	aj	cj	
0.33					
0.47	gs	js	as	cs	ds
0.68	gw	jw	aw	cw	dw
1.0	Ga	Ja	Aa	Ca	
1.5					
2.2	Gj	Jj	Aj	Cj	
3.3	Gn	Jn	An		
4.7	Gs	Js	As	Cs	
6.8	Gw	Jw			
10	GA	JA	AA		
15					
22	GJ	JJ			

PACKAGING

● MARKING

▶ A,S CASES

[SCN,SCS,SCE series]



[SCL, series]

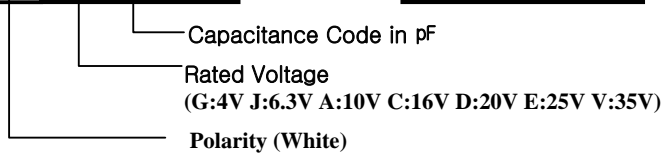

▶ B,T CASES

[SCN,SCS,SCE series]

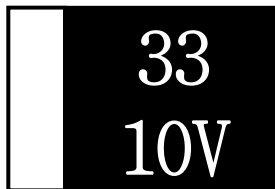

[SCL series]

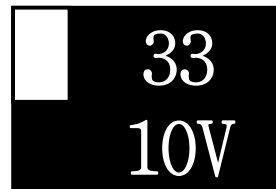

▶ C,D CASES

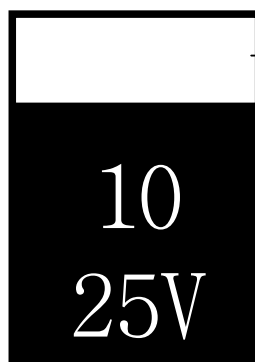

Polarity (White)

Capacitance Code in μF

Rated Voltage

● EMBOSSED PLASTIC TAPE

The tantalum chip capacitors shall be packaged in tape and reel form for effective use.

- Tape : Semitransparent embossed plastic
- Cover tape : Attached with press, polyester
- The tension of removing the cover tape, $F=10 \sim 70g$

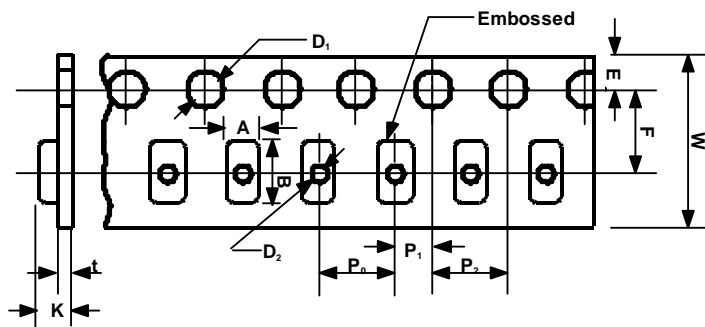
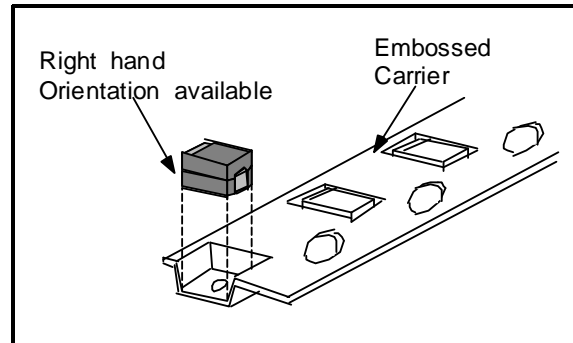

Case Code	W ± 0.3 (± 0.002)	F ± 0.1 (± 0.004)	E ± 0.1 (± 0.004)	P ± 0.1 (± 0.004)	P ± 0.1 (± 0.004)	P ± 0.1 (± 0.004)	D ± 0.1 (± 0.004)	D Min.	t	A ± 0.2 (± 0.008)	B ± 0.2 (± 0.008)	K ± 0.2 (± 0.008)
Q								$\phi 0.6$ (0.024)	0.25 (0.0098)	0.98 (0.039)	1.80 (0.071)	0.82 (0.032)
J,K												1.0 (0.039)
R										1.4 (0.055)	2.3 (0.091)	1.1 (0.043)
P	8 (0.315)	3.5 (0.138)		4 (0.157)					0.2 (0.008)			1.4 (0.055)
S			1.75 (0.069)		2 (0.079)	4 (0.157)	$\phi 1.5$ (0.059)	$\phi 1.0$ (0.039)		1.9 (0.075)	3.5 (0.138)	1.3 (0.051)
A												1.9 (0.075)
T												1.3 (0.051)
B									0.3 (0.012)	3.3 (0.130)	3.8 (0.150)	2.1 (0.083)
C	12 (0.472)	5.5 (0.217)		8 (0.315)				$\phi 1.5$ (0.059)		3.7 (0.146)	6.4 (0.252)	3.0 (0.118)
D										4.8 (0.189)	7.7 (0.303)	3.3 (0.130)

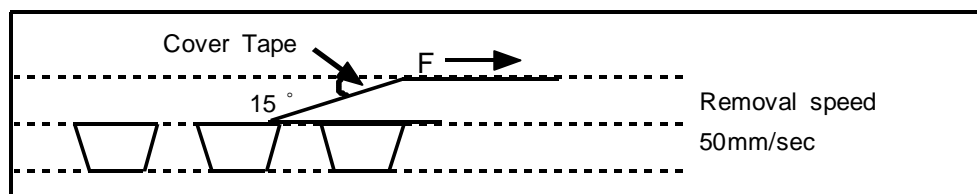

● REEL DIMENSION

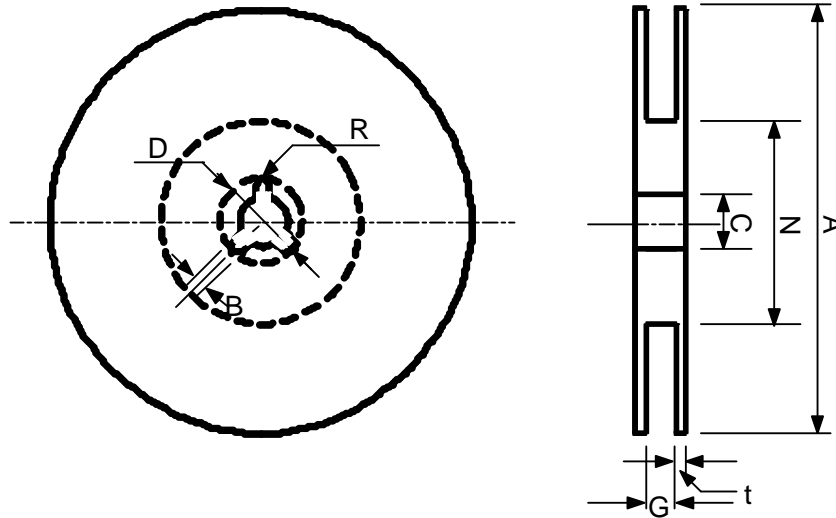

Tape Width	A±2 (±0.079)	N Min.	C±0.5 (±0.020)	D±0.5 (±0.020)	B±0.51 (±0.020)		t±0.5 (±0.020)	R
8mm	ø 178 (7)	ø 50 (1.969)	ø 13 (0.512)	ø 21 (0.827)	2 (0.079)	10 (0.394)	2 (0.079)	0.99 (0.039)
12mm						14 (0.551)		
8mm	ø 330 (13)	ø 80 (3.150)	ø 13 (0.512)	ø 21 (0.827)	2 (0.079)	10 (0.394)	2 (0.079)	0.99 (0.039)
12mm						14 (0.551)		

Case Size reference	180mm(7") reel	330mm(13") reel
J	4,000pcs	-
P	3,000pcs	-
A , B	2,000pcs	8,000pcs
C , D	500pcs	2,500pcs

APPLICATION MANUAL

The operational attentions to the use of the tantalum capacitors are as follows:

- Electrical
- Environmental
- Conditions for mounting on equipment and circuit boards
- Mechanical vibration, shock

If the tantalum capacitors are used without satisfying any one of these conditions, the probability of short-circuiting, leakage current, ignition or other problems to occur increases. To avoid such problems, observe the following precautions when using the tantalum capacitors.

● OPERATING VOLTAGE

- ▶ The voltage derating factor should be as great as possible. Under normal conditions, the operating voltage should be reduced to 50% or less of the rating. It is recommended that the operating voltage be 30% or less of the rating, particularly when the tantalum capacitors are used in a low-impedance circuit (see Figs. 1, 2, and 3).
- ▶ For circuits in which a switching, charging, discharging, or other momentary current flows, it is recommended that the operating voltage be 30% or less of the rating, with a resistor connected in series to limit the current to 300 mA or less.
- ▶ When the tantalum capacitors are to be used at an ambient temperature of higher than 85°C, the recommended operating range shown in Fig. 3 should not be exceeded.

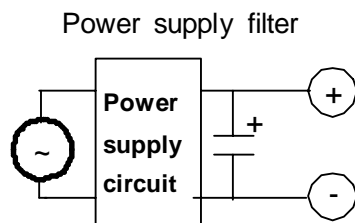

Fig. 1

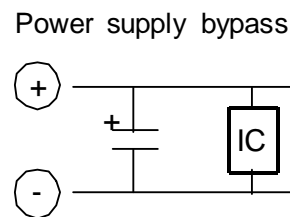

Fig. 2

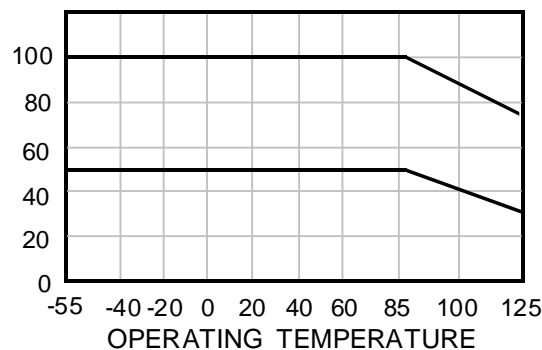

Fig. 3

● RIPPLE

The maximum permissible ripple voltage and current are related to the ratings case size.

Please consult us detail in formations.

► Ripple Current

The maximum permissible ripple current, I_{MAX} , is calculated as follows :

$$I_{MAX} = \sqrt{\frac{P_{MAX}}{ESR(f)}}$$

where:

I_{MAX} : Maximum permissible capacitor ripple current (Arms).

P_{MAX} : Maximum permissible capacitor power loss (W).

Varies with the ambient temperature and case size.

Calculated according to Table

$ESR(f)$: Capacitor equivalent series resistance (Ω).

Since the $ESR(f)$ value varies with the ripple frequency, however, the following correction must be made in accordance with the operating frequency (see Fig. 4).

$$ESR(f) = K \cdot ESR(120)$$

K : Coefficient for the operating frequency (Fig. 4).

$$ESR(120) = \tan \delta \cdot X_c = \frac{\tan \delta}{2\pi f C}$$

where:

$ESR(120)$: Equivalent series resistance at 120 Hz (Ω).

X_c : Capacitive reactance at 120 Hz (Ω).

C : Electrostatic capacitance at 120 Hz (μF).

f : Operating frequency (Hz).

Table.1 Maximum permissible power loss values (P_{MAX}) by case size

Ambient temperature (°C)	$P_{MAX}(W)$					
	J	P	A	B	C	D
25	0.015	0.015	0.030	0.030	0.030	0.050
55	0.010	0.010	0.019	0.019	0.019	0.032
85	0.005	0.005	0.010	0.010	0.010	0.018

Table.2 Hz VS K

Frequency	K
120	1.0
400	0.8
1k	0.65
10k	0.50
20k	0.45
40k	0.43
100k	0.40
1M	0.35

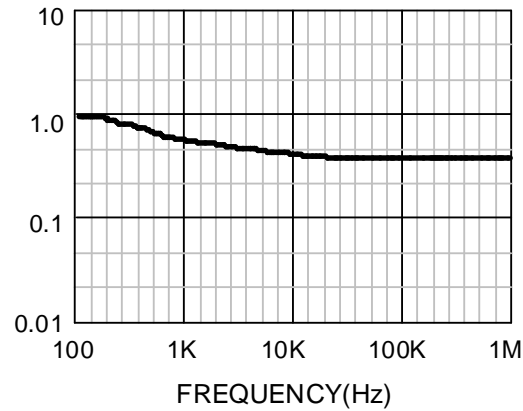
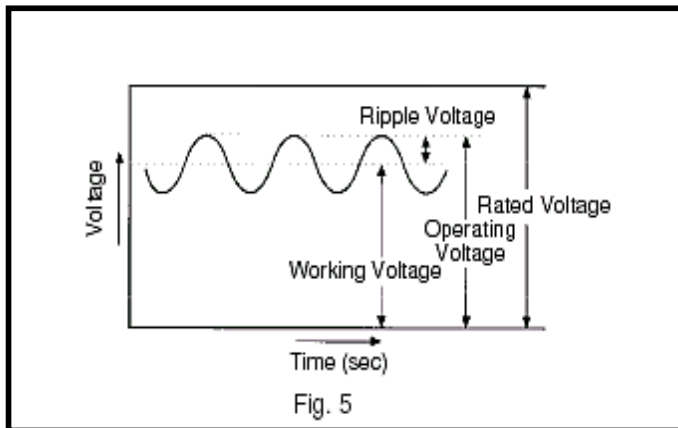

Fig.4 Correction Coefficient(K)

► Ripple Voltage

If an excessive ripple voltage is applied to the tantalum capacitors, their internal temperature rises due to Joule heat, resulting in the detriment of their reliability.



- ▷ The tantalum capacitors must be used in such a conditions that the sum of the Working Voltage and ripple voltage peak values does not exceed the rated voltage (Fig. 5)
- ▷ Ensure that an reverse voltage due to superimposed voltages is not applied to the capacitors.
- ▷ The maximum permissible ripple voltage varies with the rated voltage. Ensure that ripple voltage does not exceed the values shown in Figs 6 and 7. If, however, the capacitors are used at a high temperature, the maximum permissible ripple voltage must be calculated as follows:

$$V_{rms}(at\ 55^{\circ}C) = 0.7 \times V_{rms}(at\ 25^{\circ}C)$$

$$V_{rms}(at\ 85^{\circ}C) = 0.5 \times V_{rms}(at\ 25^{\circ}C)$$

$$V_{rms}(at\ 125^{\circ}C) = 0.3 \times V_{rms}(at\ 25^{\circ}C)$$

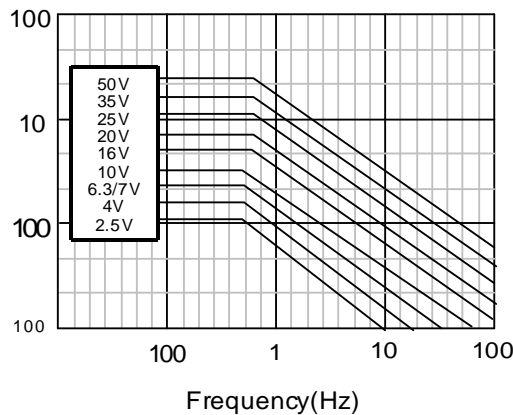

Fig.6 Maximum permissible ripple voltage (P,A,B)

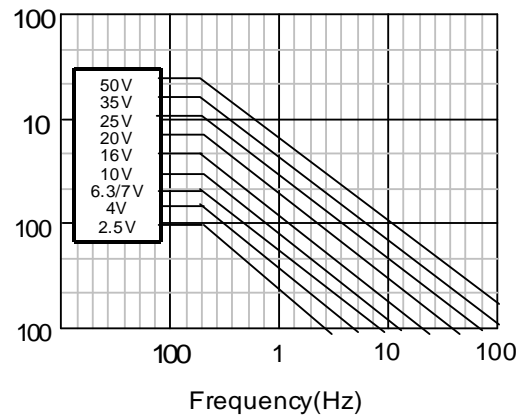

Fig.7 Maximum permissible ripple voltage (C,D)

● REVERSE VOLTAGE

Solid tantalum capacitors are polarized device and may be permanently damaged or destroyed, if connected with the wrong polarity.

- ▷ The tantalum capacitors must not be operated and changed in reverse mode. And also the capacitors must not be used in an only AC circuit.
- ▷ The tantalum capacitor dielectric has a rectifying characteristics. Therefore, when a reverse voltage is applied to it, a large current flows even at a low reverse voltage. As a result, it may spontaneously generate heat and lead to shorting.
- ▷ Make sure that the polarity and voltage is correct when applying a multi-meter or similar testing instrument to the capacitors because a reverse voltage or overvoltage can be accidentally applied.
- ▷ When using the capacitors in a circuit in which a reverse voltage is applied, consult your local SAMSUNG ELECTRO-MECHANICS agent. If the application of an reverse voltage is unavoidable, it must not exceed the following values.

At 20°C: 10% of the rated voltage of 1 V, whichever smaller.

At 85°C: 5% of the rated voltage or 0.5 V, whichever smaller.

● RELIABILITY OF TANTALUM CAPACITORS

► General

The failure rate of the tantalum capacitor varies with the digression ratio, ambient temperature, circuit resistance, circuit application, etc.

Therefore, when proper selections are made so as to afford additional margins, higher reliability can be derived from the tantalum capacitors. Some examples of actual failure rates are presented below for your reference.

► Failure Rate Calculation Formula

The tantalum capacitors are designed to work at their basic failure rates shown in Table 3 that prevail when the rated voltage is applied for 1000 hours at 85°C.

Table 3 Basic failure rate

TYPE	Classification	Basic failure rate
SCF	Face-down type	1%/1000h
SCE	Low ESR type	
SCM	Ultra-Miniature type(0603)	
SCL	Low profile type	
SCS	Small type	
SCN	Standard type	

▷ Failure rate calculation formula

$$\lambda_{use} = \lambda_{85} \times K_V \times K_R$$

λ_{use} : Estimated capacitor failure rate under the operating conditions.

λ_{85} : Basic failure rate (Table 3)

K_V : Failure rate correction coefficient by the ambient temperature and derating factor.

K_R : Failure rate correction coefficient by the circuit resistance,

which is the series-connected resistance divided by the voltage applied to the capacitor.

This resistance is connected in series when the power supply side is viewed from the capacitor side.

$K_{(derating\ factor)} = \text{operating voltage} / \text{rated voltage}$

● RELIABILITY PREDICTION

Solid tantalum capacitors exhibit no degradation failure mode during shelf storage and show a constantly decreasing failure rate (i.e., absence of wearout mechanism) during life tests. This failure rate is dependent upon three important application conditions: DC voltage, temperature, and circuit impedance.

Estimates of these respective effects are provided by the reliability nomograph. (Figure 8.)

The nomograph relates failure rate to voltage and temperature while the table relates failure rate to impedance. These estimates apply to steady-state DC condition, and they assume usage within all other rated conditions.

Standard conditions, which produce a unity failure rate factor, are rated voltage, +85°C, and 0.1 ohm-per-volt impedance.

While voltage and temperature are straight-forward, there is sometimes difficulty in determining impedance. What is required is the circuit impedance seen by the capacitor. If several capacitors are connected in parallel, the impedance seen by each is lowered by the source of energy stored in the other capacitors. Energy is similarly stored in series inductors.

Voltage "de-rating" is a common and useful approach to improved reliability. It can be pursued too far, however, when it leads to installation of higher voltage capacitors of much larger size.

It is possible to lose more via higher inherent failure rate than is gained by voltage derating. SAMSUNG typically recommends 50% derating, especially in low impedance circuits.

Failure rate is conventionally expressed in units of percent per thousand hours. As a sample calculation, suppose a particular batch of capacitors has a failure rate of 0.5% / Khr under standard conditions.

What would be the predicted failure rate at 0.7 times rated voltage, 60°C and 0.6Ω/V?

The nomograph gives a factor of 7×10^{-2} and the table gives a factor of 0.4.

The failure rate estimate is then :

$$0.5 \times 7 \times 10^{-2} \times 0.4 \\ = 1.4 \times 10^{-2} \text{ or } 0.014\%/\text{Khr}$$

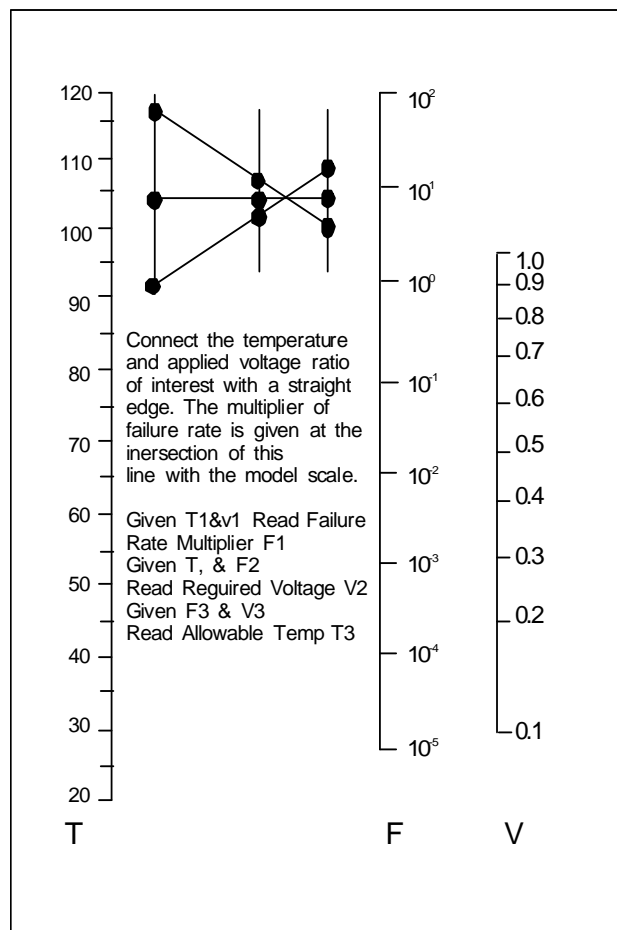

Fig.8 Reliability Nomograph

Table 4 Circuit Impedance Reliability Factors

Circuit Impedance (ohms/volt)	Failure Rate Impedance (multiplying factor)
0.1	1.0
0.2	0.8
0.4	0.6
0.6	0.4
0.8	0.3
1.0	0.2
2.0	0.1
3 or greater	0.07

● MOUNTING PRECAUTIONS

▶ Limit Pressure on Capacitor Installation with Mounter

A capacitor that has been damaged should be discarded to avoid later problems resulting from mechanical stress.

Pressure must not exceed 4.9 N with a tool end diameter of 1.5mm when applied to the capacitors using an absorber, centering tweezers, or the like. An excessively low absorber setting position would result in not only the application of undue force to the capacitors but capacitor and other component scattering, circuit board wiring breakage, and / or cracking as well, particularly when the capacitors are mounted together with other chips having a height of 1 mm or less.

▶ Flux

- ▷ Select a flux that contains a minimum of chlorine and amine.
- ▷ After flux use, the chlorine and amine in the flux remain and must therefore be removed.

▶ Recommended Soldering Pattern Dimensions

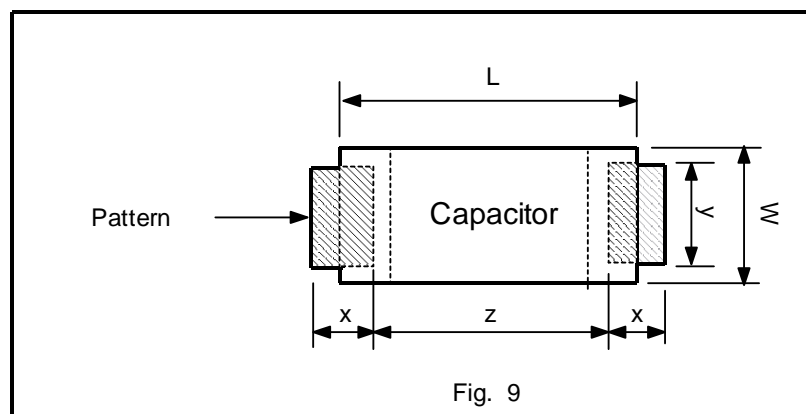

Table 4 Recommended soldering pattern dimensions(mm)

Dimensions Case	Capacitors size		Pattern dimensions		
	L	W	x	y	z
J,Q,K	1.6	0.85	0.9	1.0	0.7
P,R	2.0	1.25	1.2	1.1	0.8
A,S	3.2	1.6	1.6	1.2	1.2
B,T	3.5	2.8	1.6	2.2	1.4
C,V	5.8	3.2	2.3	2.4	2.4
D,W	7.3	4.3	2.3	2.6	3.8

► **Chip Soldering Temperature and Time**

Capacitors are capable of withstanding the following soldering temperatures and conditions;

▷ Waved soldering

Capacitor body temperature : 230°C ~ 260°C

Time : 5 seconds or less

▷ Reflow soldering see figures

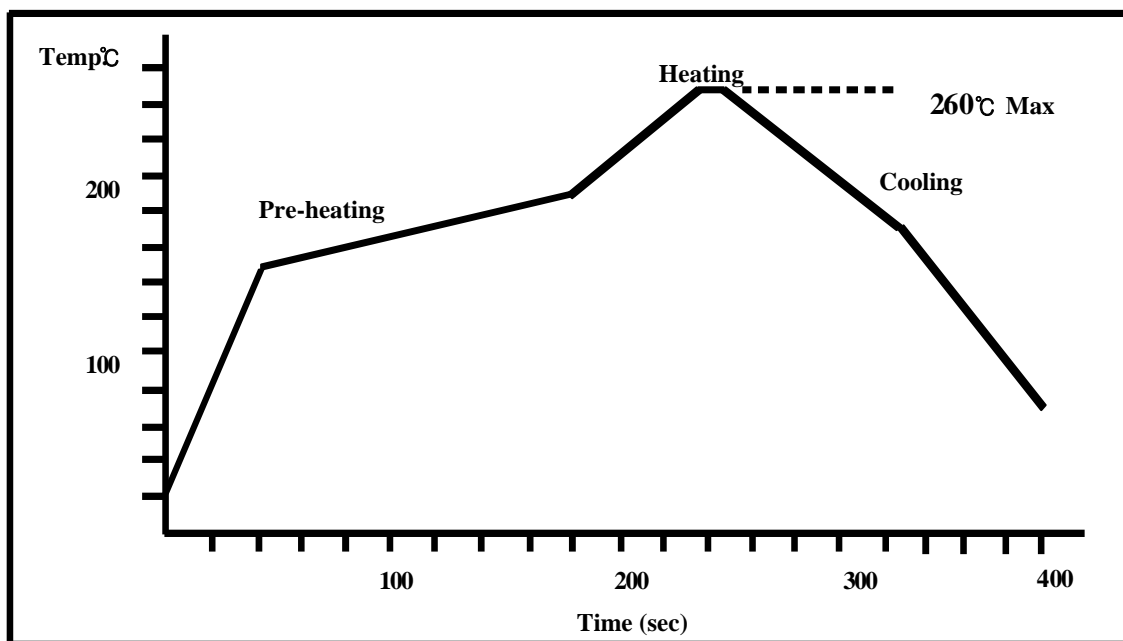

※ Recommend Temperature : 235°C ~ 245°C

(With Pb-free products, if used under 235°C, the quality confirmation must be needed.)

▷ Soldering with a soldering iron

The use of a soldering iron should be avoided wherever possible. If it is unavoidable, follow the instructions set forth in Table 5. The time of soldering with an iron should be one.

Table 5

Type	All case
Soldering-iron tip temperature	350 °C _{MAX}
Time	3 sec _{MAX}
Soldering-iron power	30 W _{MAX}

► **Cleaning after Mounting**

The following solvents are usable when cleaning the capacitors after mounting. Never use a highly active solvent.

- Halogen organic solvent (HCFC225, etc.)
- Alcoholic solvent (IPA, ethanol, etc.)
- Petroleum solvent, alkali saponifying agent, water, etc.

Circuit board cleaning must be conducted at a temperature of not higher than 50°C and for an immersion time of not longer than 30 minutes. When an ultrasonic cleaning method is used, cleaning must be conducted at a frequency of 48 kHz or lower, at a vibrator output of 0.02 W/cm³, at a temperature of not higher than 40°C, and for a time of 5 minutes or shorter.

NOTE 1: Care must be exercised in cleaning process so that the mounted capacitor will not come into contact with any cleaned object or the like or will not get rubbed by a stiff brush or the like. If such precautions are not taken particularly when the ultrasonic cleaning method is employed, terminal breakage may occur.

NOTE 2: When performing ultrasonic cleaning under conditions other than stated above, conduct adequate advance checkout.

● **OTHER**

- ▷ For further details, refer to EIAJ RCR-2368, Precautions and Guidelines for Using Electronic Device Tantalum Capacitors.
- ▷ If you have any questions, feel free to contact your local SAMSUNG ELECTRO-MECHANICS agent.