

Features

- Fully differential inputs and feedback
 - Differential input range of $\pm 2V$
 - Common-mode range of $\pm 12V$
 - High CMRR at 4 MHz of 70 dB
 - Stable at gains of 1, 2
- Calibrated and clean input clipping
- 4430—80 MHz @ $G = 1$
- 4431—160 MHz GBWP
- 380V/ μ s slew rate
- 0.02% or $^\circ$ differential gain or phase
- Operates on ± 5 to $\pm 15V$ supplies with no AC degradation

Applications

- Line receivers
- "Loop-through" interface
- Level translation
- Magnetic head pre-amplification
- Differential-to-single-ended conversion

Ordering Information

Part No.	Temp. Range	Package	Outline #
EL4430CN	-40°C to +85°C	8-pin P-DIP	MDP0031
EL4430CS	-40°C to +85°C	8-lead SO	MDP0027
EL4431CN	-40°C to +85°C	8-pin P-DIP	MDP0031
EL4431CS	-40°C to +85°C	8-lead SO	MDP0027

General Description

The EL4430 and 4431 are video instrumentation amplifiers which are ideal for line receivers, differential-to-single-ended converters, transducer interfacing, and any situation where a differential signal must be extracted from a background of common-mode noise or DC offset.

These devices have two differential signal inputs and two differential feedback terminals. The FB terminal connects to the amplifier output, or a divided version of it to increase circuit gain, and the REF terminal is connected to the output ground or offset reference.

The EL4430 is compensated to be stable at a gain of 1 or more, and the EL4431 for a gain of 2 or more.

The amplifiers have an operational temperature of $-40^\circ C$ to $+85^\circ C$ and are packaged in plastic 8-pin DIP and SO-8.

The EL4430 and EL4431 are fabricated with Elantec's proprietary complementary bipolar process which gives excellent signal symmetry and is free from latchup.

Connection Diagram

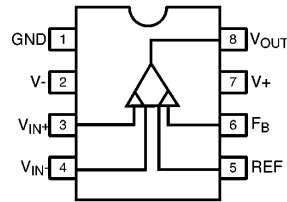

4430-1

Note: All information contained in this data sheet has been carefully checked and is believed to be accurate as of the date of publication; however, this data sheet cannot be a "controlled document". Current revisions, if any, to these specifications are maintained at the factory and are available upon your request. We recommend checking the revision level before finalization of your design documentation.

© 1996 Elantec, Inc.

EL4430C/EL4431C

Video Instrumentation Amplifiers

Absolute Maximum Ratings ($T_A = 25^\circ\text{C}$)

V_+	Positive Supply Voltage	16.5V	I_{OUT}	Continuous Output Current	30 mA
V_S	V_+ to V_- Supply Voltage	33V	P_D	Maximum Power Dissipation	See Curves
V_{IN}	Voltage at any Input or Feedback	V_+ to V_-	T_A	Operating Temperature Range	-40°C to $+85^\circ\text{C}$
ΔV_{IN}	Difference between Pairs of Inputs or Feedback	6V	T_S	Storage Temperature Range	-60°C to $+150^\circ\text{C}$
I_{IN}	Current into any Input, or Feedback Pin	4 mA			

Important Note:

All parameters having Min/Max specifications are guaranteed. The Test Level column indicates the specific device testing actually performed during production and Quality inspection. Elantec performs most electrical tests using modern high-speed automatic test equipment, specifically the LTX77 Series system. Unless otherwise noted, all tests are pulsed tests, therefore $T_J = T_C = T_A$.

Test Level	Test Procedure
I	100% production tested and QA sample tested per QA test plan QCX0002.
II	100% production tested at $T_A = 25^\circ\text{C}$ and QA sample tested at $T_A = 25^\circ\text{C}$, T_{MAX} and T_{MIN} per QA test plan QCX0002.
III	QA sample tested per QA test plan QCX0002.
IV	Parameter is guaranteed (but not tested) by Design and Characterization Data.
V	Parameter is typical value at $T_A = 25^\circ\text{C}$ for information purposes only.

Open-Loop DC Electrical Characteristics

Power supplies at $\pm 5\text{V}$, $T_A = 25^\circ$. For the EL4431, $R_F = R_G = 500\Omega$.

Parameter	Description	Min	Typ	Max	Test Level	Units
V_{DIFF}	Differential input voltage - Clipping ($V_{CM} = 0$)	2.0	2.3		I	V
	0.1% nonlinearity		1.8		V	V
V_{CM}	Common-mode range ($V_{DIFF} = 0$)	$V_S = \pm 5\text{V}$	± 2	± 3.0	I	V
		$V_S = \pm 15\text{V}$	± 12	± 13.0	I	V
V_{OS}	Input offset voltage		2	8	I	mV
I_B	Input bias current (IN_+ , IN_- , REF, and FB terminals)		12	20	I	μA
I_{OS}	Input offset current between IN_+ and IN_- and between REF and FB		0.2	2	I	μA
R_{IN}	Input resistance	100	230		I	$\text{k}\Omega$
CMRR	Common-mode rejection ratio	70	90		I	dB
PSRR	Power supply rejection ratio		60		V	dB
E_G	Gain error, excluding feedback resistors	-1.5	-0.2	+0.5	I	%
V_O	Output voltage swing	EL4430, $V_S = \pm 5\text{V}$	± 2	± 2.8	I	V
		$V_S = \pm 15\text{V}$	± 12	± 12.8	I	V
		EL4431, $V_S = \pm 5\text{V}$	± 2.5	± 3.0	I	V
		$V_S = \pm 15\text{V}$	± 12.5	± 13.0	I	V
I_{SC}	Output short-circuit current	40	90		I	mA
I_S	Supply current, $V_S = \pm 15\text{V}$		13.5	16	I	mA

EL4430C/EL4431C

Video Instrumentation Amplifiers

Closed-Loop AC Electrical Characteristics Power supplies at $\pm 12\text{V}$, $T_A = 25^\circ\text{C}$, $R_L = 500\Omega$ for the EL4430, $R_L = 150\Omega$ for the EL4431, $C_L = 15\text{ pF}$. For the EL4431, $R_F = R_G = 500\Omega$.

Parameter	Description	Min	Typ	Max	Test Level	Units	
BW, -3 dB	-3 dB small-signal bandwidth		EL4430	82		V	MHz
			EL4431	80		V	MHz
BW, ± 0.1 dB	0.1 dB flatness bandwidth		EL4430	20		V	MHz
			EL4431	14		V	MHz
Peaking	Frequency response peaking		EL4430	0.6		V	dB
			EL4431	1.0		V	dB
SR	Slew rate, V_{OUT} between -2V and $+2\text{V}$	All	380		V	$\text{V}/\mu\text{s}$	
V_N	Input-referred noise voltage density	EL4430/31	26		V	$\text{nV}/\text{rt-Hz}$	
dG	Differential gain error, Voffset between -0.7V and $+0.7\text{V}$	EL4430		0.02		V	%
			EL4431, $R_L = 150\Omega$		0.04		V
d θ	Differential gain error, Voffset between -0.7V and $+0.7\text{V}$	EL4430		0.02		V	($^\circ$)
			EL4431, $R_L = 150\Omega$		0.08		V
T_S	Settling time, to 0.1% from a 4V step	EL4430	48		V	ns	

Test Circuit

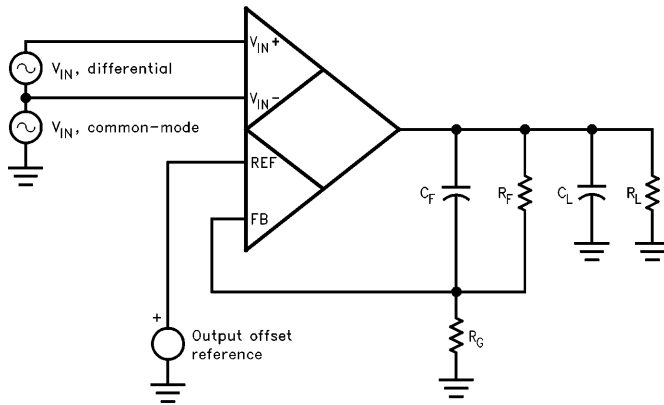

4430-3

Typical Performance Curves

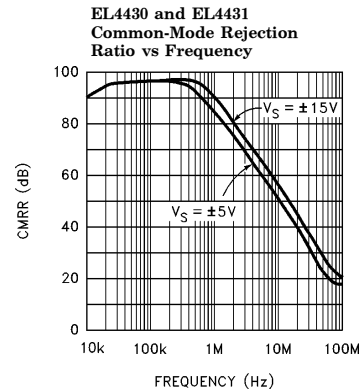

EL4430C/EL4431C

Video Instrumentation Amplifiers

Typical Performance Curves — Contd.

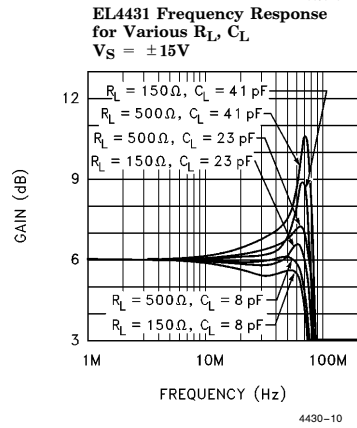
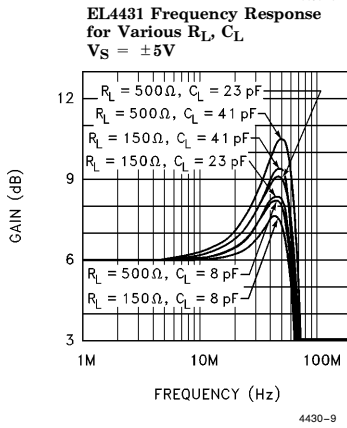
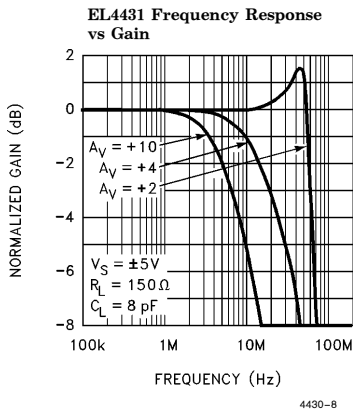
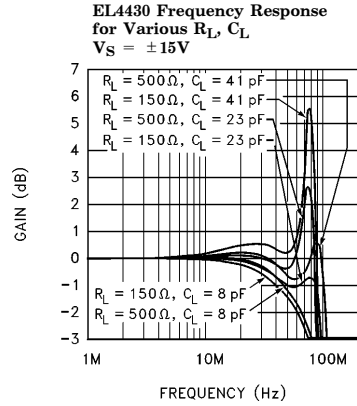
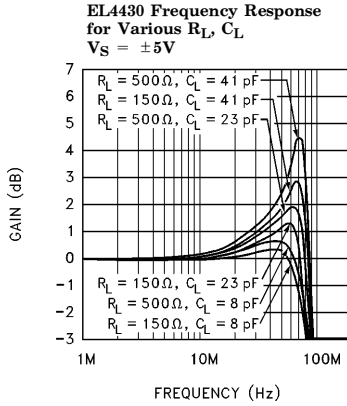
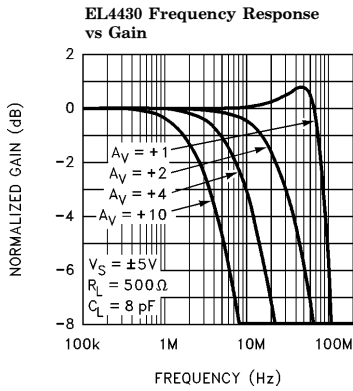

EL4430C/EL4431C

Video Instrumentation Amplifiers

Typical Performance Curves — Contd.

EL4430 Differential Gain and Phase vs Input Offset Voltage for $V_S = \pm 5V$

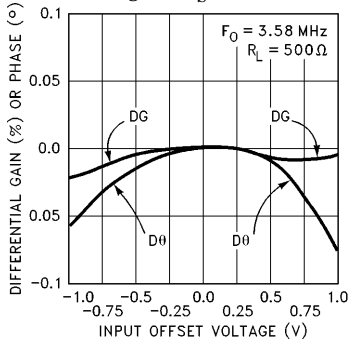

4430-14

EL4430 Differential Gain and Phase vs Input Offset Voltage for $V_S = \pm 12V$

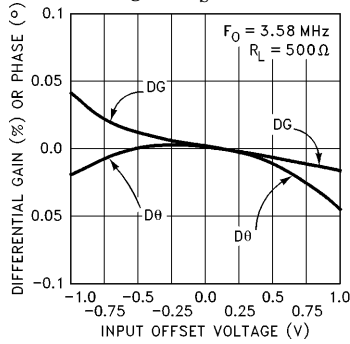

4430-15

EL4430 Differential Gain and Phase Error vs R_L

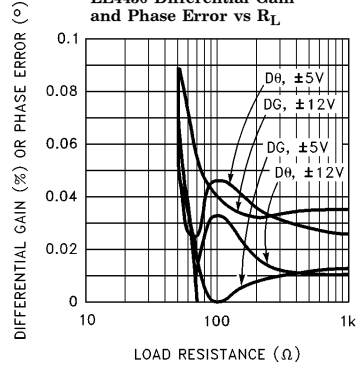

4430-16

EL4431 Differential Gain and Phase vs Input Offset Voltage for $V_S = \pm 5V$

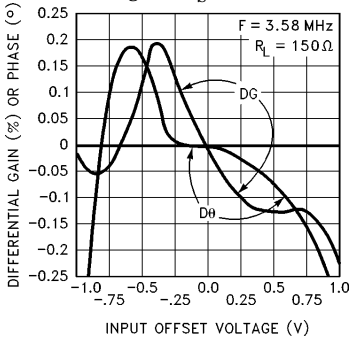

4430-17

EL4431 Differential Gain and Phase vs Input Offset Voltage for $V_S = \pm 12V$

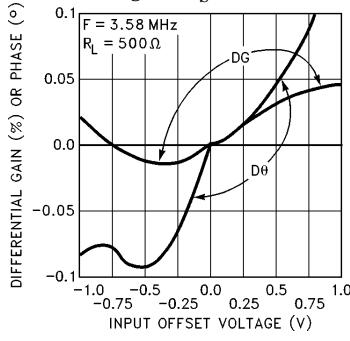

4430-18

EL4431 Differential Gain and Phase Error vs R_L

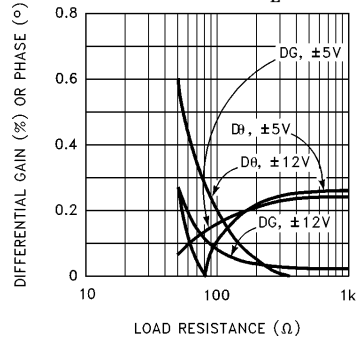

4430-19

EL4430 Nonlinearity vs Input Signal Span

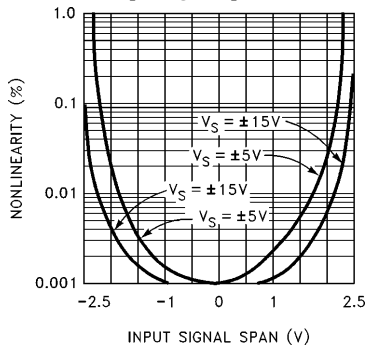

4430-20

EL4431 Nonlinearity vs Input Signal Span

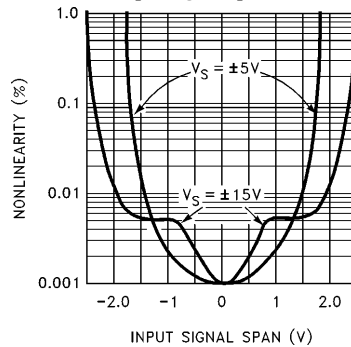

4430-21

EL4430C/EL4431C

Video Instrumentation Amplifiers

Typical Performance Curves — Contd.

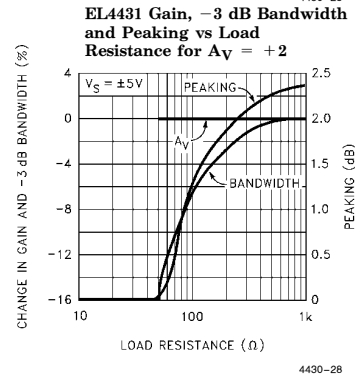
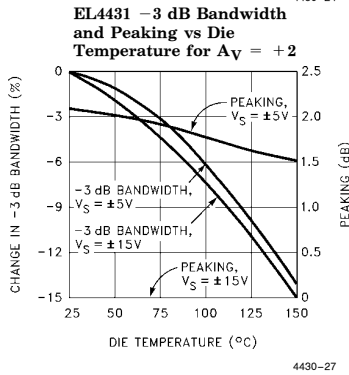
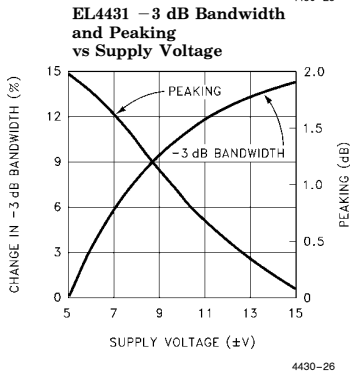
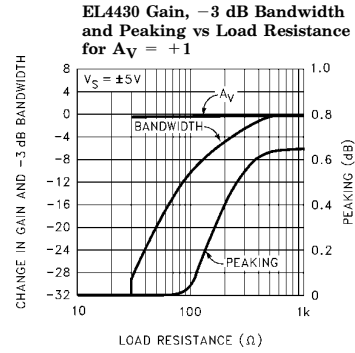
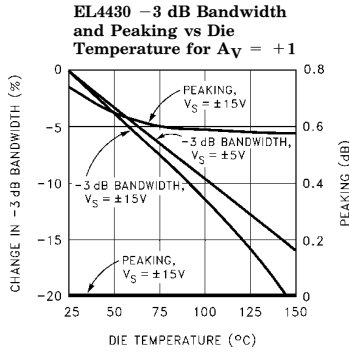
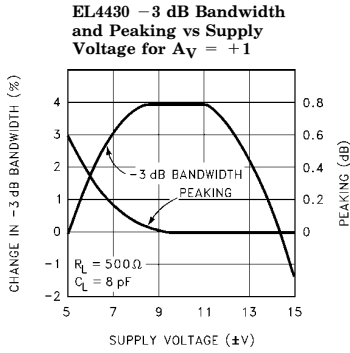

EL4430C/EL4431C

Video Instrumentation Amplifiers

Typical Performance Curves — Contd.

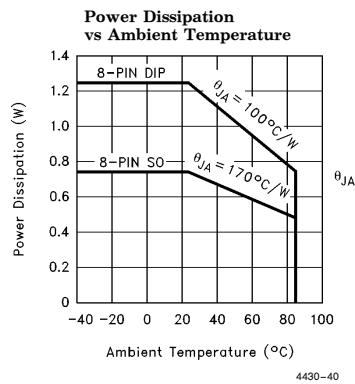
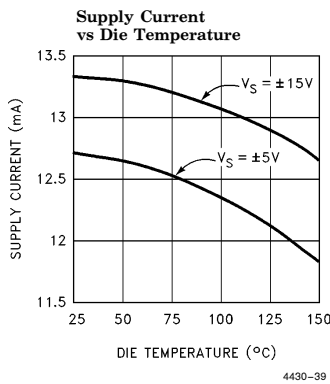
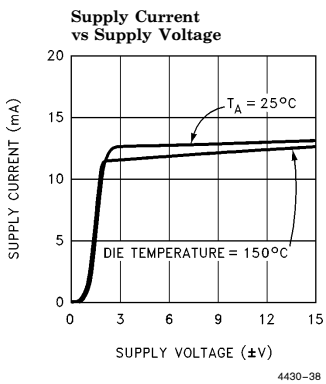
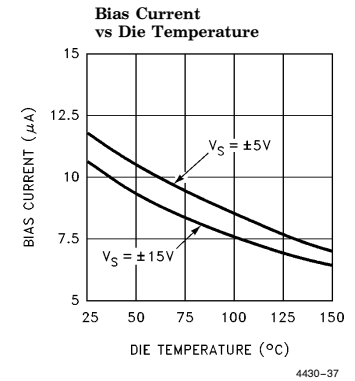
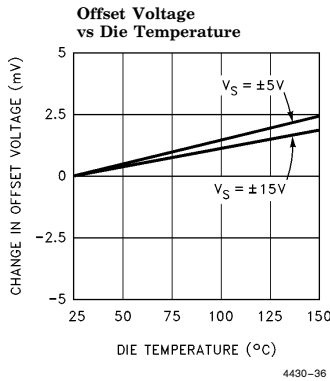
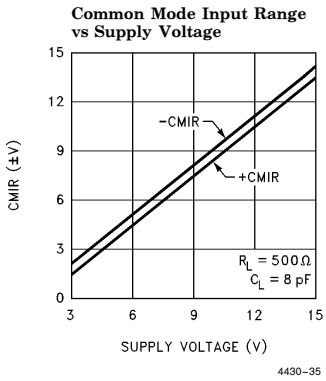
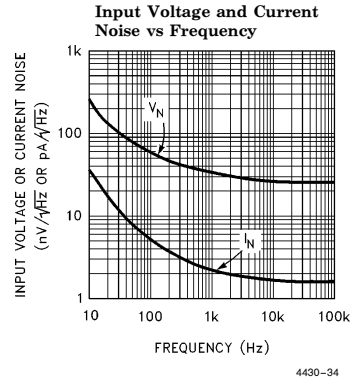
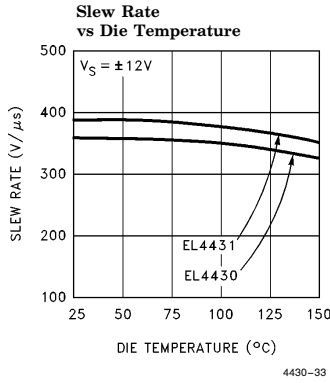
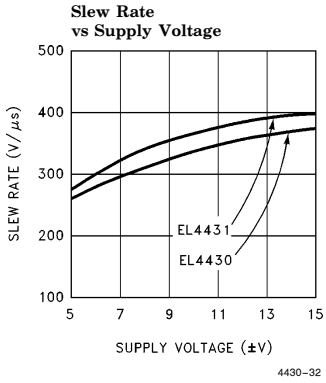

EL4430C/EL4431C

Video Instrumentation Amplifiers

Applications Information

The EL4430 and EL4431 are designed to convert a fully differential input to a single-ended output. It has two sets of inputs; one which is connected to the signal and does not respond to its common-mode level, and another which is used to complete a feedback loop with the output. Here is a typical connection:

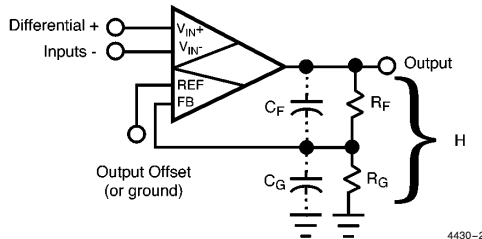

The gain of the feedback divider is H . The transfer function of the part is

$$V_{OUT} = A_O \times ((V_{IN+}) - (V_{IN-}) + (V_{REF} - V_{FB})).$$

V_{FB} is connected to V_{OUT} through a feedback network, so $V_{FB} = H \times V_{OUT}$. A_O is the open-loop gain of the amplifier, and is about 600 for the EL4430 and EL4431. The large value of A_O drives

$$(V_{IN+}) - (V_{IN-}) + (V_{REF} - V_{FB}) \rightarrow 0.$$

Rearranging and substituting for V_{FB}

$$V_{OUT} = ((V_{IN+}) - (V_{IN-}) + V_{REF})/H.$$

Thus, the output is equal to the difference of the V_{IN} 's and offset by V_{REF} , all gained up by the feedback divider ratio. The input impedance of the FB terminal (equal to R_{IN} of the input terminals) is in parallel with an R_G , and raises circuit gain slightly.

The EL4430 is stable for a gain of 1 (a direct connection between V_{OUT} and FB) or more and the EL4431 for gains of 2 or more. It is important to keep the feedback divider's impedance at the FB terminal low so that stray capacitance does not diminish the loop's phase margin. The pole caused by the parallel of resistors R_F and R_G and

stray capacitance should be at least 200 MHz; typical strays of 3 pF thus require a feedback impedance of 270Ω or less. Two 510Ω resistors are acceptable for a gain of 2; 300Ω and 2700Ω make a good gain-of-10 divider. Alternatively, a small capacitor across R_F can be used to create more of a frequency-compensated divider. The value of the capacitor should scale with the parasitic capacitance at the FB terminal input. It is also practical to place small capacitors across both the feedback resistors (whose values maintain the desired gain) to swamp out parasitics. For instance, two 10 pF capacitors (for a gain of 2) across equal divider resistors will dominate parasitic effects and allow a higher divider resistance.

Input Connections

The input transistors can be driven from resistive and capacitive sources, but are capable of oscillation when presented with an inductive input. It takes about 80nH of series inductance to make the inputs actually oscillate, equivalent to 4" of unshielded wiring or about 6" of unterminated input transmission line. The oscillation has a characteristic frequency of 500 MHz. Often, placing one's finger (via a metal probe) or an oscilloscope probe on the input will kill the oscillation. Normal high-frequency construction obviates any such problems, where the input source is reasonably close to the input. If this is not possible, one can insert series resistors of approximately 51Ω to de-Q the inputs.

Signal Amplitudes

Signal input common-mode voltage must be between $(V-) + 3V$ and $(V+) - 3V$ to ensure linearity. Additionally, the differential voltage on any input stage must be limited to $\pm 6V$ to prevent damage. The differential signal range is $\pm 2V$ in the EL4430 and EL4431. The input range is substantially constant with temperature.

The Ground Pin

The ground pin draws only 6μA maximum DC current, and may be biased anywhere between $(V-) + 2.5V$ and $(V+) - 3.5V$. The ground pin is connected to the IC's substrate and frequency compensation components. It serves as a shield within the IC and enhances CMRR over frequency, and if connected to a potential other than ground, it must be bypassed.

EL4430C/EL4431C

Video Instrumentation Amplifiers

Applications Information — Contd.

Power Supplies

The instrumentation amplifiers work well on any supplies from $\pm 3V$ to ± 15 . The supplies may be of different voltages as long as the requirements of the Gnd pin are observed (see the Ground Pin section for a discussion). The supplies should be bypassed close to the device with short leads. $4.7\mu F$ tantalum capacitors are very good, and no smaller bypasses need be placed in parallel. Capacitors as low as $0.01\mu F$ can be used if small load currents flow.

Single-polarity supplies, such as $+12V$ with $+5V$ can be used, where the ground pin is connected to $+5V$ and V- to ground. The inputs and outputs will have to have their levels shifted above ground to accommodate the lack of negative supply.

The dissipation of the amplifiers increases with power supply voltage, and this must be compatible with the package chosen. This is a close estimate for the dissipation of a circuit:

$$P_D = 2 \times V_S \times I_{S, \max} + (V_S - V_O) \times V_O / R_{PAR}$$

where $I_{S, \max}$ is the maximum supply current

V_S is the \pm supply voltage (assumed equal)

V_O is the output voltage

R_{PAR} is the parallel of all resistors loading the output

For instance, the EL4431 draws a maximum of 16 mA and we might require a 2V peak output into 150Ω and a $270\Omega + 270\Omega$ feedback divider. The R_{PAR} is 117Ω . The dissipation with $\pm 5V$ supplies is 201 mW. The maximum supply voltage that the device can run on for a given P_D and the other parameter is

$$V_{S, \max} = (P_D + V_O^2 / R_{PAR}) / (2I_S + V_O / R_{PAR})$$

The maximum dissipation a package can offer is

$$P_{D, \max} = (T_{J, \max} - T_{A, \max}) / \theta_{JA}$$

where $T_{J, \max}$ is the maximum die junction temperature, $150^\circ C$ for reliability, less to retain optimum electrical performance.

$T_{A, \max}$ is the ambient temperature, $70^\circ C$ for commercial and $85^\circ C$ for industrial range.

θ_{JA} is the thermal resistance of the mounted package, obtained from data-sheet dissipation curves.

The more difficult case is the SO-8 package. With a maximum die temperature of $150^\circ C$ and a maximum ambient temperature of $85^\circ C$, the $65^\circ C$ temperature rise and package thermal resistance of $170^\circ C/W$ gives a dissipation of 382 mW at $85^\circ C$. This allows a maximum supply voltage of $\pm 8.5V$ for the EL4431 operated in our example. If an EL4430 were driving a light load ($R_{PAR} \rightarrow \infty$), it could operate on $\pm 15V$ supplies at a $70^\circ C$ maximum ambient.

Output Loading

The output stage of the instrumentation amplifiers is very powerful. It typically can source 80 mA and sink 120 mA. Of course, this is too much current to sustain and the part will eventually be destroyed by excessive dissipation or by metal traces on the die opening. The metal traces are completely reliable while delivering the 30 mA continuous output given in the Absolute Maximum Ratings table in this datasheet, or higher purely transient currents.

Gain or gain accuracy degrades only 10% from no load to 100Ω load. Heavy resistive loading will degrade frequency response and video distortion for loads $< 100\Omega$

Capacitive loads will cause peaking in the frequency response. If capacitive loads must be driven, a small-valued series resistor can be used to isolate it (12Ω to 51Ω should suffice). A 22Ω series resistor will limit peaking to 2.5 dB with even a 220 pF load.

EL4430C/EL4431C

Video Instrumentation Amplifiers

- * Macromodel
- * This is a Pspice-compatible macromodel of the EL4430 video instrumentation amplifier assembled as a subcircuit. The pins are numbered sequentially
- * as the subcircuit interface nodes. T1 is a transmission line which provides
- * a good emulation of the more complicated real device. This model correctly
- * displays the characteristics of input clipping, frequency response, CMRR
- * both AC and DC, output clipping, output sensitivity to capacitive loads,
- * gain accuracy, slewrate limiting, input bias current and impedance. The
- * macromodel does not exhibit proper results with respect to supply current,
- * supply sensitivities, offsets, output current limit, differential gain or
- * phase, nor temperature.
- * Connections:

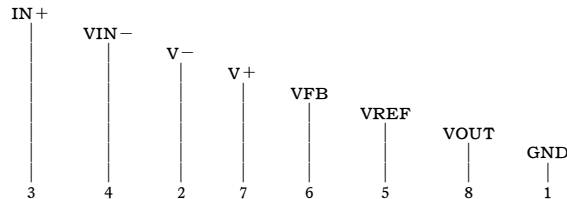

```
.SUBCKT EL4430/EL      3      4      2      7      6      5      8      1
***
*** EL4430 macromodel ***
***
*****
i1 7 10 .00103
i2 7 11 .00103
i3 7 12 .00105
i4 7 13 .00105
v1 7 14 3
v2 7 15 3
v3 19 2 3
*****
c1 11 1 .03p
c2 12 1 .03p
c3 18 1 2.1p
c4 16 17 0.6p
*****
r1 10 11 2000
r2 12 13 2000
r3 10 1 30e6
r4 16 2 1000
r5 17 2 1000
r6 18 1 1.27e6
r7 23 21 20
r8 21 8 100
*****
l1 21 8 50n
*****
d1 11 14 diode
d2 12 14 diode
d3 18 15 diode
d4 19 18 diode
.model diode d(tt=120n)
*****
q1 16 3 10 1 pnp
q2 17 4 11 1 pnp
q3 16 5 12 1 pnp
q4 17 6 13 1 pnp
.model pnp pnp (bf=90 va=44 tr=50n)
*****
g1 18 1 17 16 .0005
e1 20 1 1 18 1.0
t1 22 1 20 1 z0=50 td=1.5n
r1t1 22 1 50
e2 23 1 22 1 1.0
*****
.ENDS
```

EL4430C/EL4431C

Video Instrumentation Amplifiers

EL4430C/EL4431C Macromodel — Contd.

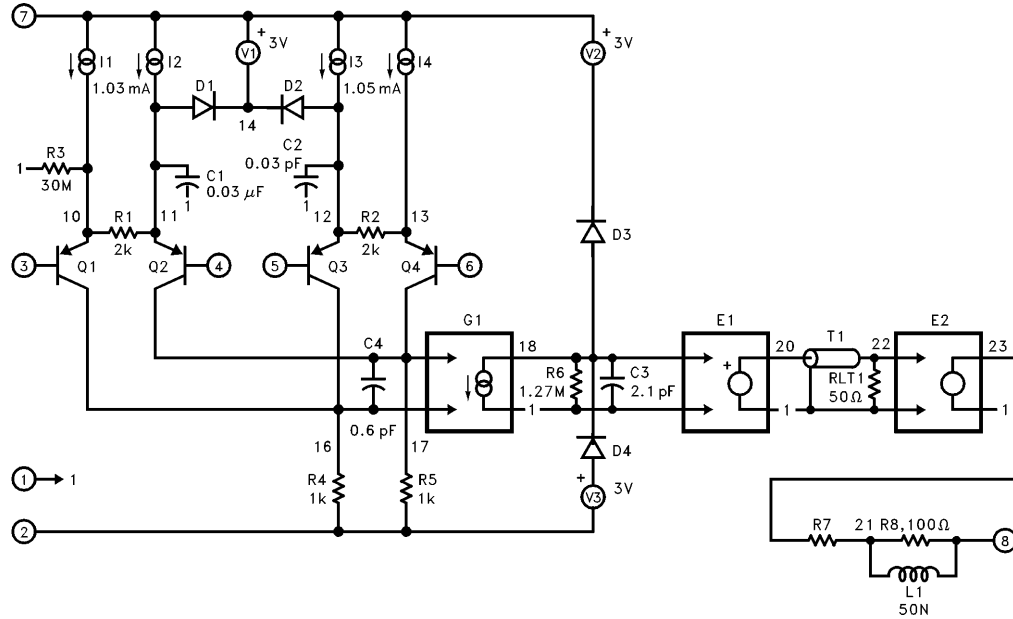

4430-41

EL4430C/EL4431C

Video Instrumentation Amplifiers

General Disclaimer

Specifications contained in this data sheet are in effect as of the publication date shown. Elantec, Inc. reserves the right to make changes in the circuitry or specifications contained herein at any time without notice. Elantec, Inc. assumes no responsibility for the use of any circuits described herein and makes no representations that they are free from patent infringement.

élantec
HIGH PERFORMANCE ANALOG INTEGRATED CIRCUITS

Elantec, Inc.

1996 Tarob Court

Milpitas, CA 95035

Telephone: (408) 945-1323

(800) 333-6314

Fax: (408) 945-9305

European Office: 44-71-482-4596

WARNING — Life Support Policy

Elantec, Inc. products are not authorized for and should not be used within Life Support Systems without the specific written consent of Elantec, Inc. Life Support systems are equipment intended to support or sustain life and whose failure to perform when properly used in accordance with instructions provided can be reasonably expected to result in significant personal injury or death. Users contemplating application of Elantec, Inc. products in Life Support Systems are requested to contact Elantec, Inc. factory headquarters to establish suitable terms & conditions for these applications. Elantec, Inc.'s warranty is limited to replacement of defective components and does not cover injury to persons or property or other consequential damages.