

### General Description

The MIC860 is a rail-to-rail output, operational amplifier in *Teeny™* SC70 packaging. The MIC860 provides 4MHz gain-bandwidth product while consuming an incredibly low 30µA supply current.

The SC70 packaging achieves significant board space savings over devices packaged in SOT-23 or MSOP-8 packaging. The SC70 occupies approximately half the board area of a SOT-23 package.

### Features

- *Teeny™* SC70 packaging
- 4MHz gain-bandwidth product
- 30µA supply current
- Rail-to-Rail output
- Ground sensing at input common mode to GND
- Common mode to GND
- Drive large capacitive loads

### Applications

- Portable equipment
- PDAs
- Pagers
- Cordless Phones
- Consumer Electronics

### Ordering Information

Part Number				Ambient Temp. Range	Package
Standard	Marking	Pb-Free	Marking*		
MIC860BC5	A32	MIC860YC5	<u>A32</u>	-40°C to +85°C	SC-70-5

\* Underbar marking may not be to scale.

### Pin Configuration

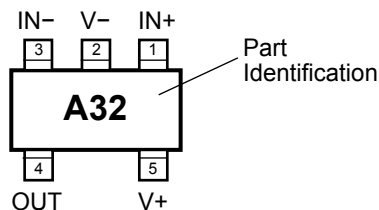

SC-70

### Functional Pinout

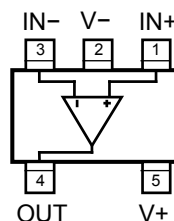

**Absolute Maximum Ratings (Note 1)**

Supply Voltage ( $V_{V+} - V_{-}$ ).....	+6.0V
Differential Input Voltage ( $ V_{IN+} - V_{IN-} $ ), Note 4 .....	+6.0V
Input Voltage ( $V_{IN+} - V_{IN-}$ ) .....	$V_{+} + 0.3V$ , $V_{-} - 0.3V$
Lead Temperature (soldering, 5 sec.).....	260°C
Output Short Circuit Current Duration .....	Indefinite
Storage Temperature ( $T_S$ ) .....	150°C
ESD Rating, <b>Note 3</b>	

**Operating Ratings (Note 2)**

Supply Voltage ( $V_{+} - V_{-}$ ) .....	+2.43V to +5.25V
Ambient Temperature Range.....	-40°C to +85°C
Package Thermal Resistance.....	450°C/W

**Electrical Characteristics**

$V_{+} = +2.7V$ ,  $V_{-} = 0V$ ,  $V_{CM} = V_{+}/2$ ;  $R_L = 500k\Omega$  to  $V_{+}/2$ ;  $T_A = 25^{\circ}C$ , unless otherwise noted. **Bold** values indicate  $-40^{\circ}C \leq T_A \leq +85^{\circ}C$ .

Symbol	Parameter	Condition	Min	Typ	Max	Units
$V_{OS}$	Input Offset Voltage		-20	-5	15	mV
			-25		20	mV
	Input Offset Voltage Temp Coefficient			20		$\mu V/^{\circ}C$
$I_B$	Input Bias Current			20		pA
$I_{OS}$	Input Offset Current			10		pA
$V_{CM}$	Input Voltage Range	CMRR > 60dB	<b>1</b>	1.8		V
CMRR	Common-Mode Rejection Ratio	$0 < V_{CM} < 1.35V$	<b>38</b>	76		dB
PSRR	Power Supply Rejection Ratio	Supply voltage change of 3V	<b>40</b>	78		dB
$A_{VOL}$	Large-Signal Voltage Gain	$R_L = 5k$ , $V_{OUT}$ 2V peak to peak	<b>50</b>	66		dB
		$R_L = 100k$ , $V_{OUT}$ 2V peak to peak	<b>66</b>	81		dB
		$R_L = 500k$ , $V_{OUT}$ 2V peak to peak	<b>76</b>	91		dB
$V_{OUT}$	Maximum Output Voltage Swing	$R_L = 5k$	<b>V+-70mV</b>	V+-34mV		V
		$R_L = 500k$	<b>V+-2mV</b>	V+-0.7mV		V
$V_{OUT}$	Minimum Output Voltage Swing	$R_L = 5k$		V-+11mV	<b>V-+ 50mV</b>	mV
		$R_L = 500k$		V-+0.2mV	<b>V-+ 2mV</b>	mV
GBW	Gain-Bandwidth Product			4		MHz
SR	Slew Rate			3		V/ $\mu s$
$I_{SC}$	Short-Circuit Output Current	Source	<b>4.5</b>	6		mA
		Sink	<b>10</b>	16		mA
$I_S$	Supply Current	No Load		30	50	$\mu A$

$V_{+} = +5V$ ,  $V_{-} = 0V$ ,  $V_{CM} = V_{+}/2$ ;  $R_L = 500k\Omega$  to  $V_{+}/2$ ;  $T_A = 25^{\circ}C$ , unless otherwise noted. **Bold** values indicate  $-40^{\circ}C \leq T_A \leq +85^{\circ}C$ .

$V_{OS}$	Input Offset Voltage		-20	-5	20	mV
	Input Offset Voltage Temp Coefficient			20		$\mu V/^{\circ}C$
$I_B$	Input Bias Current			20		pA
$I_{OS}$	Input Offset Current			10		pA
$V_{CM}$	Input Voltage Range	CMRR > 60dB	<b>3.5</b>	4.2		V
CMRR	Common-Mode Rejection Ratio	$0 < V_{CM} < 3.5V$	<b>44</b>	77		dB
PSRR	Power Supply Rejection Ratio	Supply voltage change of 1V	<b>40</b>	79		dB
$A_{VOL}$	Large-Signal Voltage Gain	$R_L = 5k$ , $V_{OUT}$ 4.8V peak to peak	<b>52</b>	66		dB
		$R_L = 100k$ , $V_{OUT}$ 4.8V peak to peak	<b>67</b>	80		dB
		$R_L = 500k$ , $V_{OUT}$ 4.8V peak to peak	<b>75</b>	90		dB

Symbol	Parameter	Condition	Min	Typ	Max	Units
$V_{OUT}$	Maximum Output Voltage Swing	$R_L = 5k$	V+-75mV	V+-37mV		V
		$R_L = 500k$	V+-35mV	V+-4mV		V
$V_{OUT}$	Minimum Output Voltage Swing	$R_L = 5k$		V-+14mV	V-+ 40mV	mV
		$R_L = 500k$		V-+0.4mV	V-+ 5mV	mV
GBW	Gain-Bandwidth Product			4		MHz
SR	Slew Rate			3		V/ $\mu$ s
$I_{SC}$	Short-Circuit Output Current	Source	15	23		mA
		Sink	30	47		mA
$I_S$	Supply Current	No Load		33	55	$\mu$ A

**Note 1.** Exceeding the absolute maximum rating may damage the device.

**Note 2.** The device is not guaranteed to function outside its operating rating.

**Note 3.** Devices are ESD sensitive. Handling precautions recommended. Human body model, 1.5k in series with 100pF. Pin 4 is ESD sensitive

**Note 4.** Exceeding the maximum differential input voltage will damage the input stage and degrade performance (in particular, input bias current is likely to increase).

Test Circuits

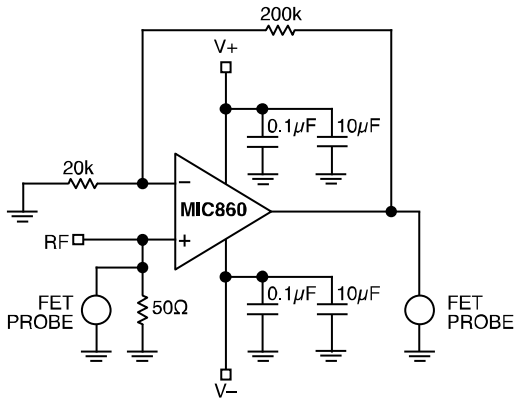

Test Circuit 1.  $A_V = 10$

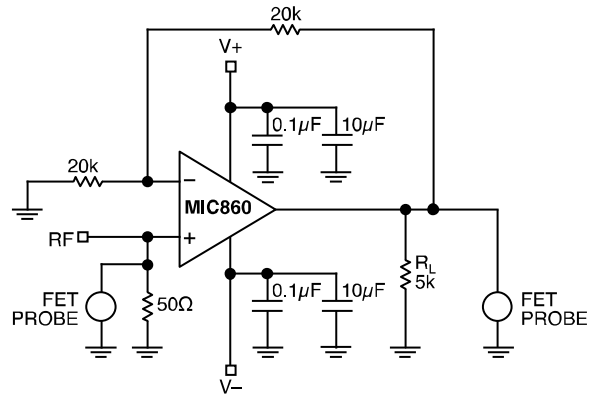

Test Circuit 2.  $A_V = 2$

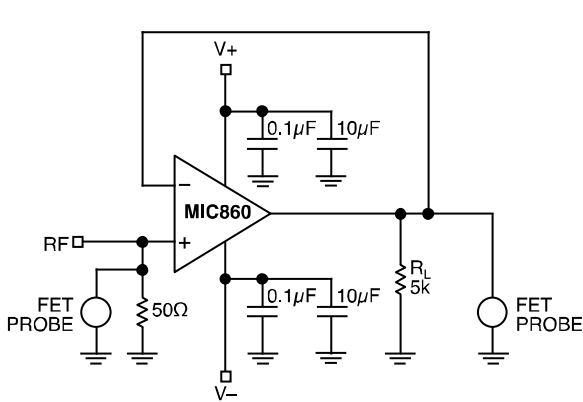

Test Circuit 3.  $A_V = 1$

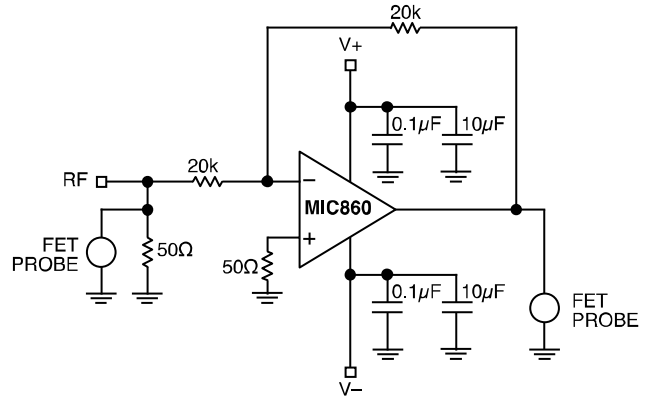

Test Circuit 4.  $A_V = -1$

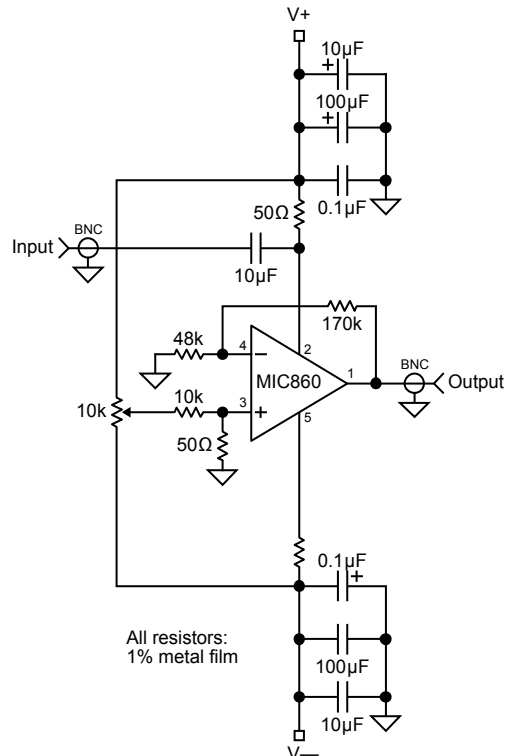

All resistors:  
1% metal film

Test Circuit 5. Positive Power Supply Rejection Ratio Measurement

# Typical Characteristics

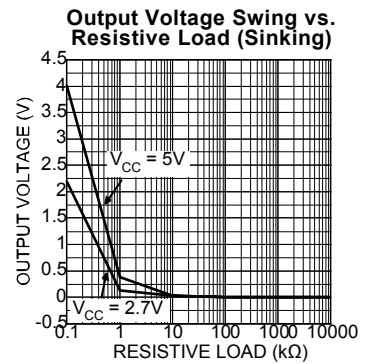
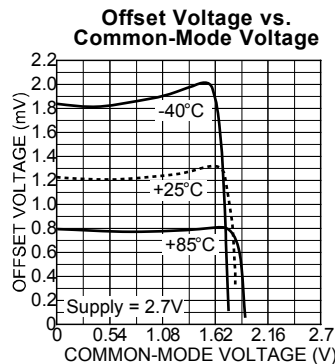
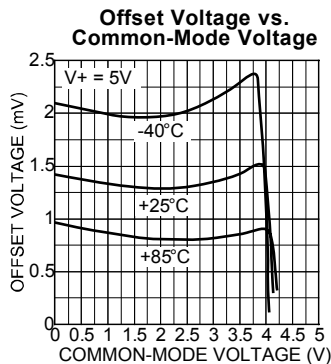
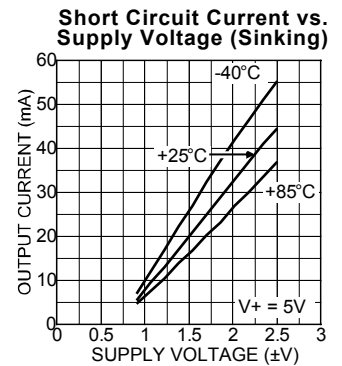
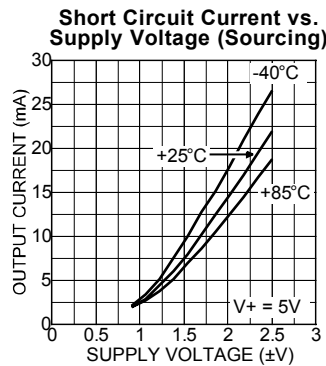
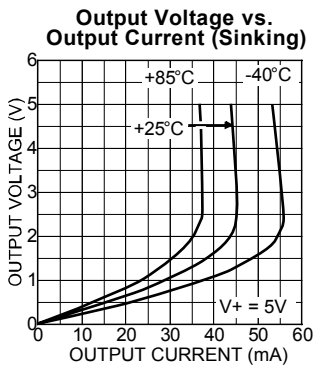
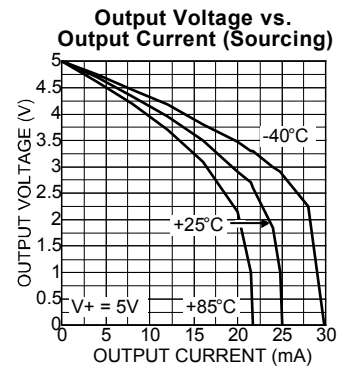
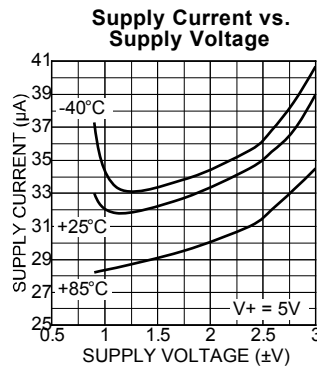
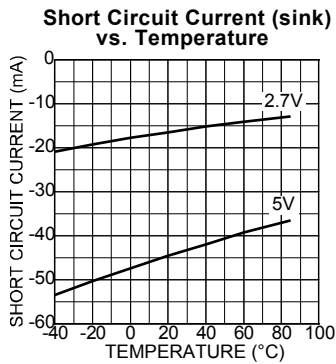
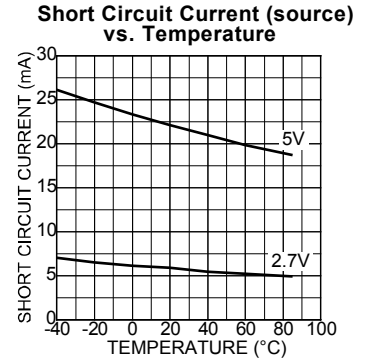
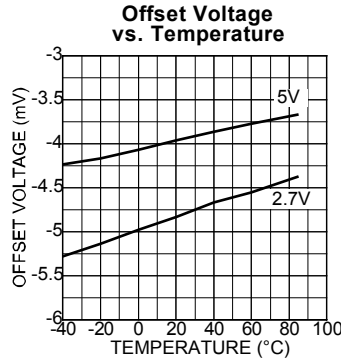
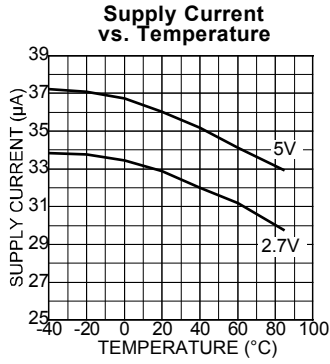

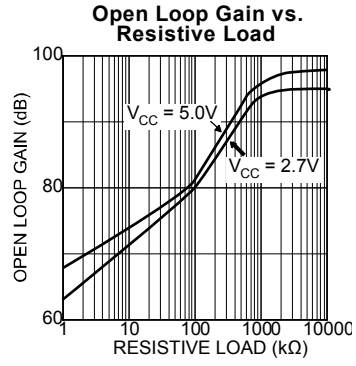
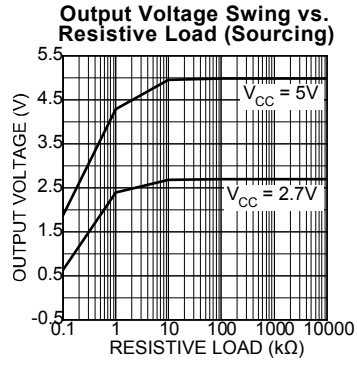

# Functional Characteristics

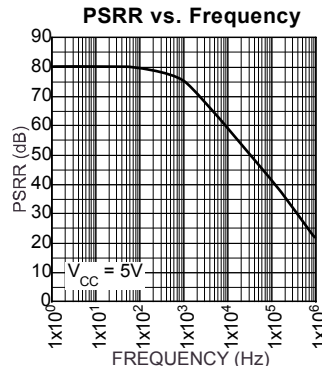
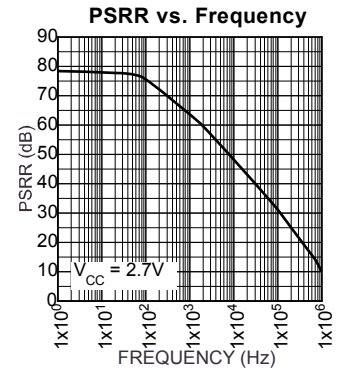
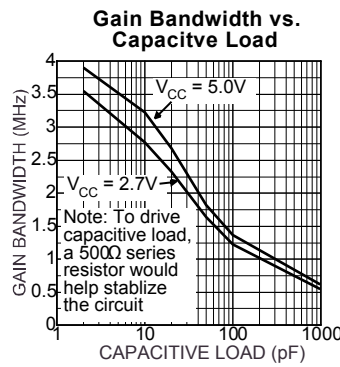
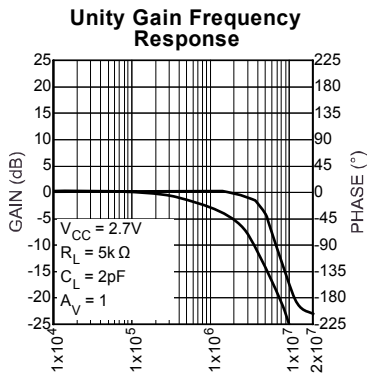
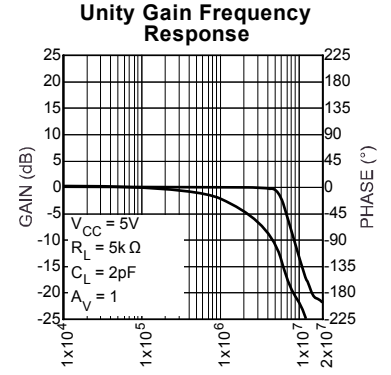
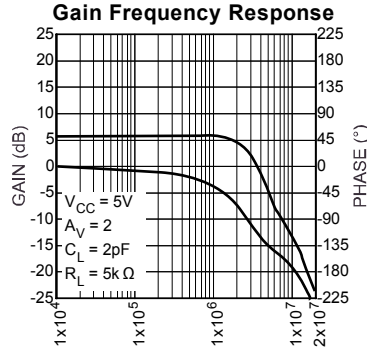
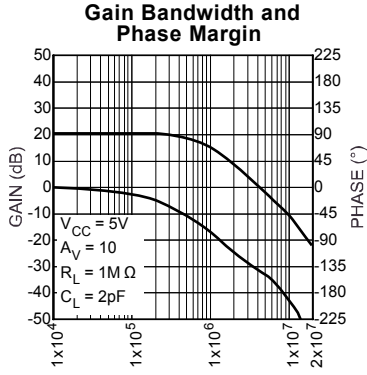

**Small Signal Response**  
**Test Circuit 3:  $A_v = 1$**

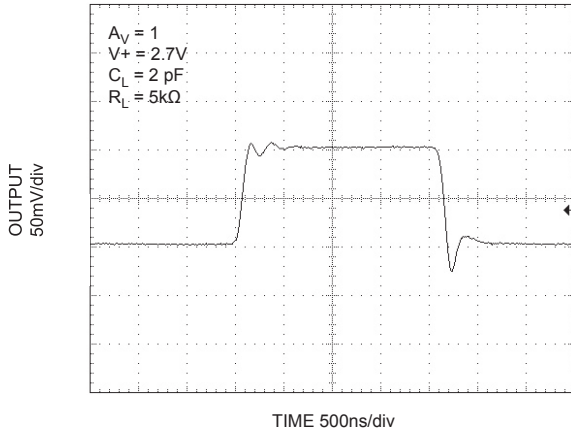

**Small Signal Response**  
**Test Circuit 3:  $A_v = 1$**

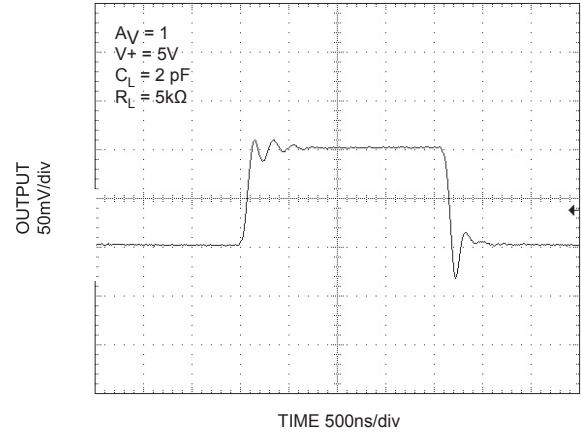

**Small Signal Response**  
**Test Circuit 3:  $A_v = 1$**

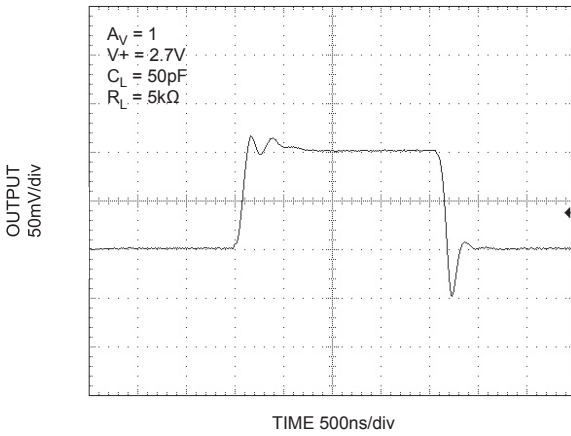

**Small Signal Response**  
**Test Circuit 3:  $A_v = 1$**

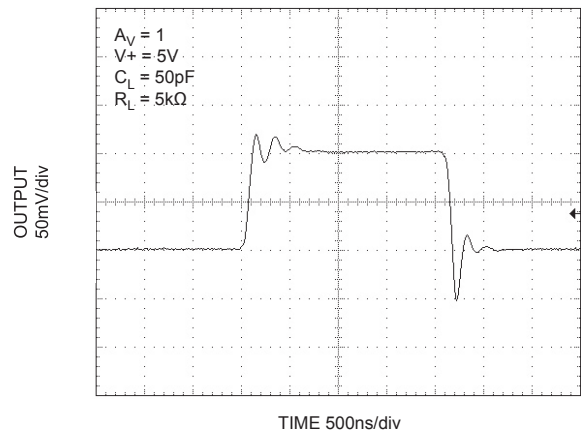

**Small Signal Response**  
**Test Circuit 3:  $A_v = 1$**

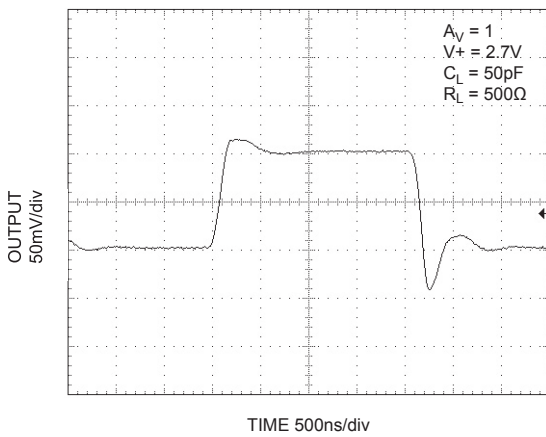

**Small Signal Response**  
**Test Circuit 3:  $A_v = 1$**

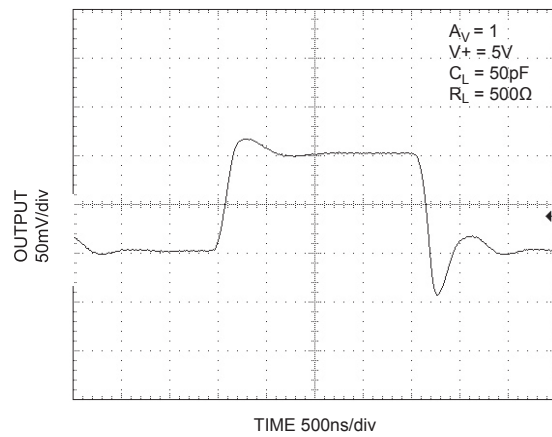



**Small Signal Response**  
**Test Circuit 3:  $A_V = 1$**

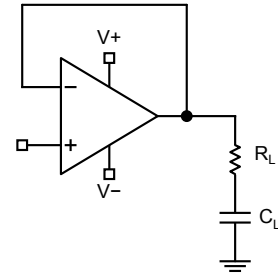
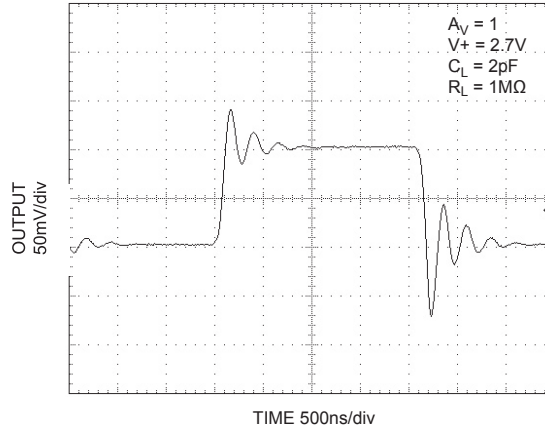

**Small Signal Response**  
**Test Circuit 4:  $A_V = -1$**

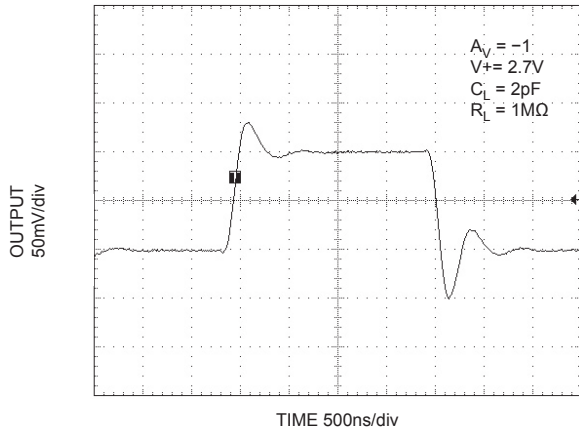

**Small Signal Response**  
**Test Circuit 4:  $A_V = -1$**

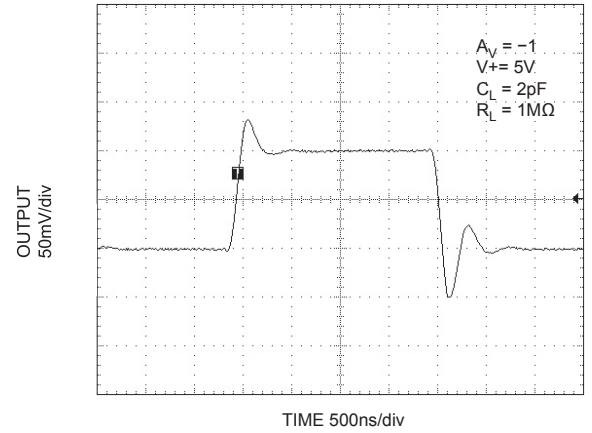

**Small Signal Response**  
**Test Circuit 4:  $A_V = -1$**

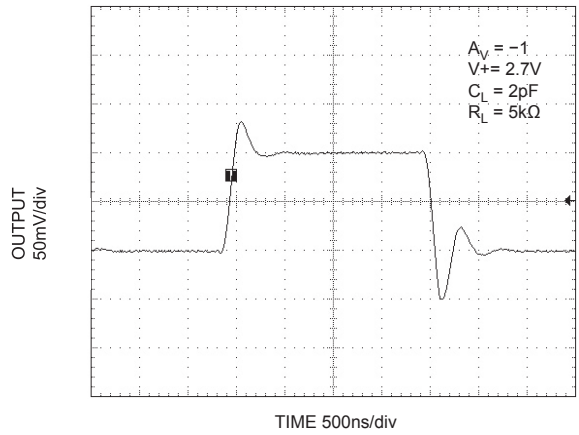

**Small Signal Response**  
**Test Circuit 4:  $A_V = -1$**

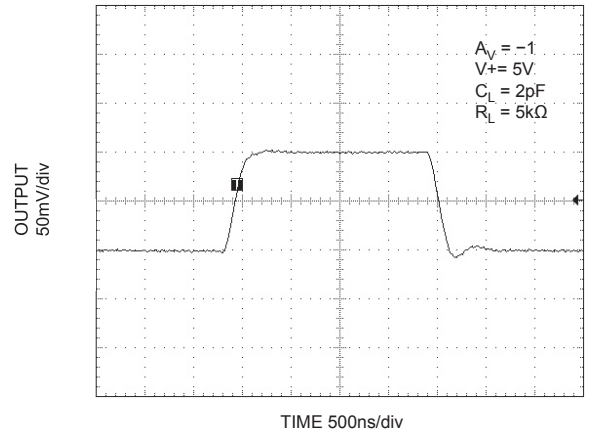

**Rail to Rail Output Operation**  
Test Circuit 2:  $A_V = 2$

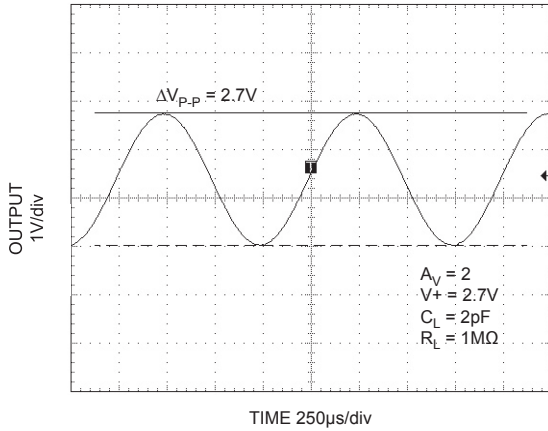

**Rail to Rail Output Operation**  
Test Circuit 2:  $A_V = 2$

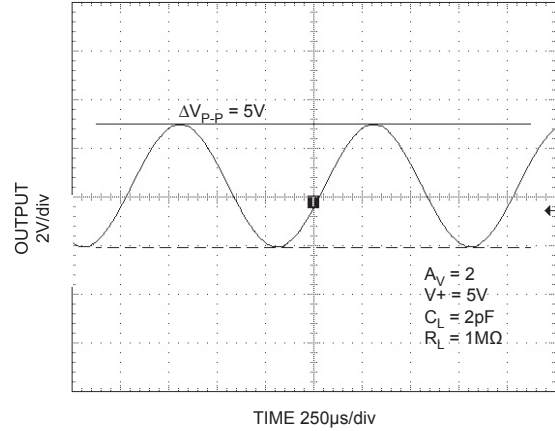

**Rail to Rail Output Operation**  
Test Circuit 2:  $A_V = 2$

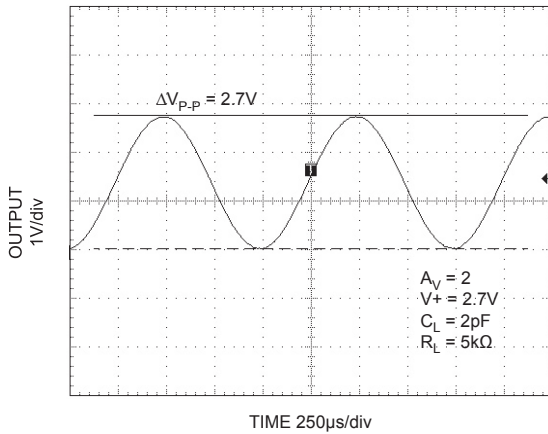

**Rail to Rail Output Operation**  
Test Circuit 2:  $A_V = 2$

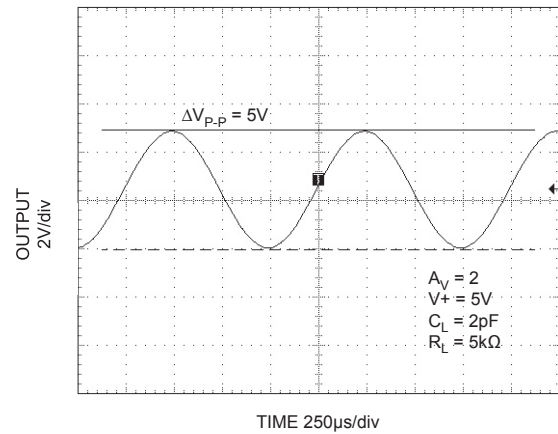

**Large Signal Pulse Response**  
Test Circuit 3:  $A_V = 1$

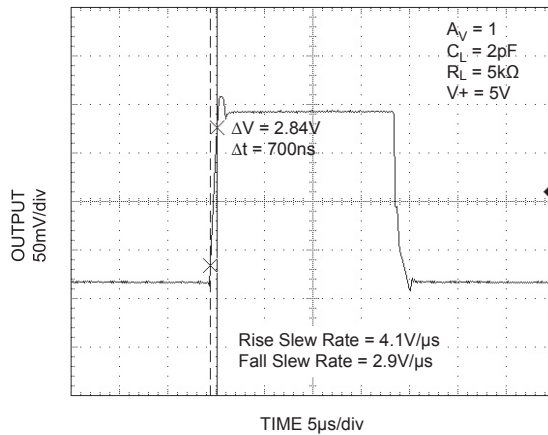

**Large Signal Pulse Response**  
Test Circuit 3:  $A_V = 1$

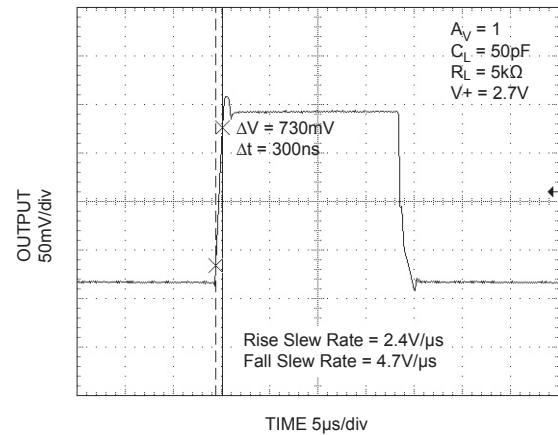

## Applications Information

### Power Supply Bypassing

Regular supply bypassing techniques are recommended. A 10 $\mu$ F capacitor in parallel with a 0.1 $\mu$ F capacitor on both the positive and negative supplies are ideal. For best performance all bypassing capacitors should be located as close to the op amp as possible and all capacitors should be low ESL (equivalent series inductance), ESR (equivalent series resistance). Surface-mount ceramic capacitors are ideal.

### Supply and Loading Considerations

The MIC860 is intended for single supply applications configured with a grounded load. It is not advisable to operate the MIC860 with either:

- 1). A grounded load and split supplies (+/-V) or
- 2). A single supply where the load is terminated above ground.

Under the above conditions, if the load is less than 20kOhm and the output swing is greater than 1V(peak), there may be some instability when the output is sinking current.

## Package Information

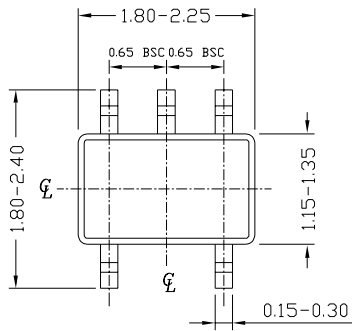

TOP VIEW

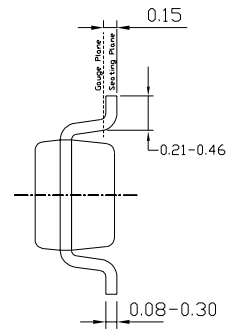

END VIEW

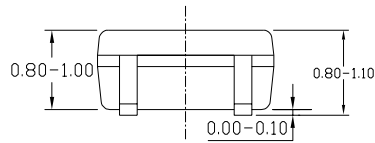

SIDE VIEW

NOTE:

1. ALL DIMENSIONS ARE IN MILLIMETERS.
2. DIMENSIONS ARE INCLUSIVE OF PLATING.
3. DIMENSIONS ARE EXCLUSIVE OF MOLD FLASH & METAL BURR.

### SC70-5

**MICREL INC. 2180 FORTUNE DRIVE SAN JOSE, CA 95131 USA**  
 TEL + 1 (408) 944-0800 FAX + 1 (408) 474-1000 WEB <http://www.micrel.com>

This information furnished by Micrel in this data sheet is believed to be accurate and reliable. However no responsibility is assumed by Micrel for its use. Micrel reserves the right to change circuitry and specifications at any time without notification to the customer.

Micrel Products are not designed or authorized for use as components in life support appliances, devices or systems where malfunction of a product can reasonably be expected to result in personal injury. Life support devices or systems are devices or systems that (a) are intended for surgical implant into the body or (b) support or sustain life, and whose failure to perform can be reasonably expected to result in a significant injury to the user. A Purchaser's use or sale of Micrel Products for use in life support appliances, devices or systems is a Purchaser's own risk and Purchaser agrees to fully indemnify Micrel for any damages resulting from such use or sale.

© 2002 Micrel, Inc.