

Features:

- PI74FCT373/573T are pin compatible with bipolar FAST™ Series at a higher speed and lower power consumption
- TTL input and output levels
- Low ground bounce outputs
- Extremely low static power
- Hysteresis on all inputs
- Industrial operating temperature range: -40°C to $+85^{\circ}\text{C}$
- Device models available upon request
- Packaging:
PI74FCT373T (Pb-free & Green available)
 - 20-pin TSSOP (L)
 - 20-pin QSOP (Q)
 - 20-pin SOIC (S)

- PI74FCT573T (Pb-free & Green available)
- 20-pin QSOP (Q)
 - 20-pin SOIC (S)

Description:

Pericom Semiconductor's PI74FCT373T and PI74FCT 573T are 8-bit wide octal transparent latches designed with 3-state outputs and are intended for bus oriented applications. When Latch Enable (LE) is HIGH, the flip-flops appear transparent to the data. The data that meets the set-up time when LE is LOW is latched. When $\overline{\text{OE}}$ is HIGH, the bus output is in the high impedance state.

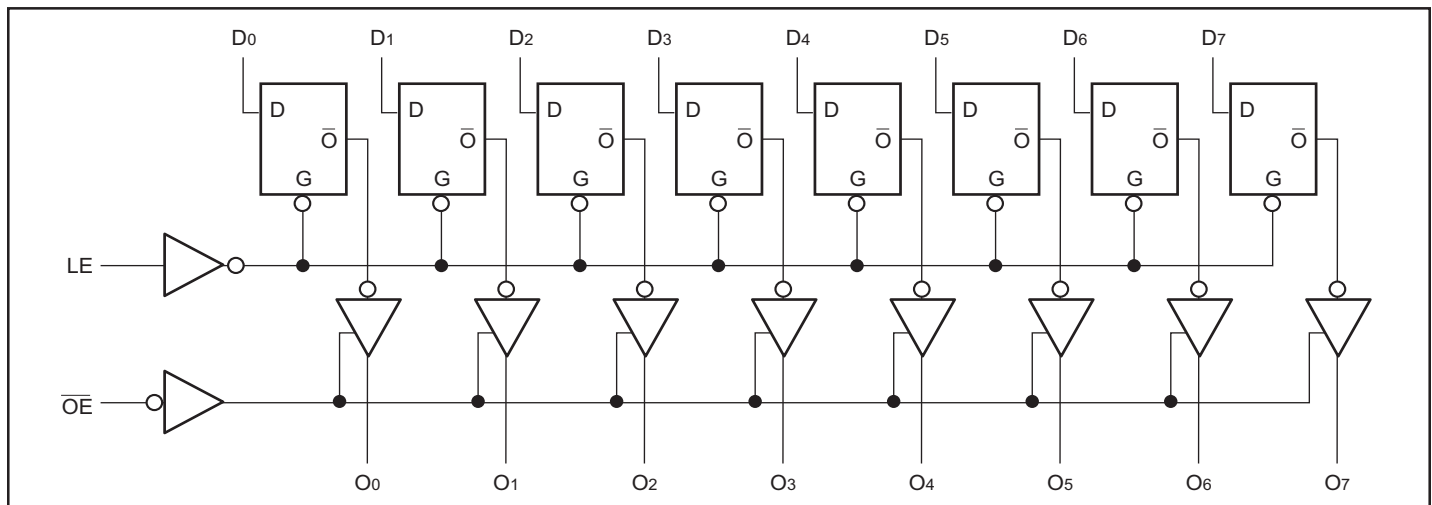
Block Diagram

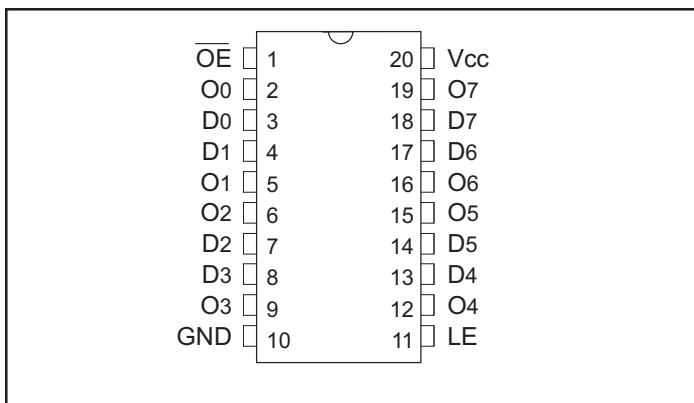
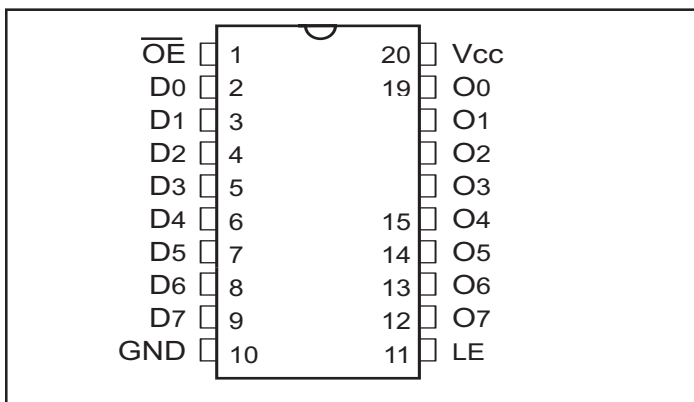
PI74FCT373 Pin Configuration

PI74FCT573 Pin Configuration

Pin Description

Pin Name	Description
\overline{OE}	Output Enable Input (Active LOW)
LE	Latch Enable Input (Active HIGH)
D0-D7	Data Inputs
O0-O7	3-State Outputs
$\overline{O0-O7}$	Complementary 3-State Outputs
GND	Ground
Vcc	Power

Truth Table⁽¹⁾

Inputs			Outputs
D _N	LE	\overline{OE}	O _N
H	H	L	H
L	H	L	L
X	X	H	Z

Notes:

1. H = High Voltage Level
L = Low Voltage Level
X = Don't Care
Z = High Impedance

Maximum Ratings

(Above which the useful life may be impaired. For user guidelines, not tested.)

Storage Temperature	-65°C to +150°C
Ambient Temperature with Power Applied	-40°C to +85°C
Supply Voltage to Ground Potential (Inputs & Vcc Only)	-0.5V to +7.0V
Supply Voltage to Ground Potential (Outputs & D/O Only)	-0.5V to +7.0V
DC Input Voltage	-0.5V to +7.0V
DC Output Current	120 mA
Power Dissipation	0.5W

Note:

Stresses greater than those listed under MAXIMUM RATINGS may cause permanent damage to the device. This is a stress rating only and functional operation of the device at these or any other conditions above those indicated in the operational sections of this specification is not implied. Exposure to absolute maximum rating conditions for extended periods may affect reliability.

DC Electrical Characteristics (Over the Operating Range, $T_A = -40^\circ\text{C}$ to $+85^\circ\text{C}$, $V_{CC} = 5.0\text{V} \pm 5\%$)

Parameters	Description	Test Conditions ⁽¹⁾		Min.	Typ ⁽²⁾	Max.	Units
V _{OH}	Output HIGH Voltage	V _{CC} = Min., V _{IN} = V _{IH} or V _{IL}	I _{OH} = -15.0 mA	2.4	3.0		V
V _{OL}	Output LOW Current	V _{CC} = Min., V _{IN} = V _{IH} or V _{IL}	I _{OL} = 64 mA		0.3	0.55	V
V _{IH}	Input HIGH Voltage	Guaranteed Logic HIGH Level		2.0			V
V _{IL}	Input LOW Voltage	Guaranteed Logic LOW Level				0.8	V
I _{IH}	Input HIGH Current	V _{CC} = Max.	V _{IN} = V _{CC}			1	μA
I _{IL}	Input LOW Current	V _{CC} = Max.	V _{IN} = GND			-1	μA
I _{OZH}	High Impedance	V _{CC} = Max.	V _{OUT} = 2.7V			1	μA
I _{OZL}	Output Current		V _{OUT} = 0.5V			-1	μA
V _{IK}	Clamp Diode Voltage	V _{CC} = Min., I _{IN} = -18 mA			-0.7	-1.2	V
I _{OFF}	Power Down Disable	V _{CC} = GND, V _{OUT} = 4.5V				100	μA
I _{OS}	Short Circuit Current	V _{CC} = Max. ⁽³⁾ , V _{OUT} = GND		-60	-120		mA
V _H	Input Hysteresis				200		mV

Notes:

1. For Max. or Min. conditions, use appropriate value specified under Electrical Characteristics for the applicable device type.
2. Typical values are at V_{CC} = 5.0V, +25°C ambient and maximum loading.
3. Not more than one output should be shorted at one time. Duration of the test should not exceed one second.

Capacitance ($T_A = 25^\circ\text{C}$, $f = 1\text{ MHz}$)

Parameters ⁽¹⁾	Description	Test Conditions	Typ	Max.	Units
C _{IN}	Input Capacitance	V _{IN} = 0V	6	10	pF
C _{OUT}	Output Capacitance	V _{OUT} = 0V	8	12	pF

Notes:

1. This parameter is determined by device characterization but is not production tested.

Power Supply Characteristics

Parameters	Description	Test Conditions ⁽¹⁾		Min.	Typ ⁽²⁾	Max.	Units
I _{CC}	Quiescent Power Supply Current	V _{CC} = Max.	V _{IN} = GND or V _{CC}		0.1	500	μA
ΔI _{CC}	Supply Current per Input @ TTL HIGH	V _{CC} = Max.,	V _{IN} = 3.4V ⁽³⁾		0.5	2.0	mA
I _{CCD}	Supply Current per Input per MHz ⁽⁴⁾	V _{CC} = Max., Outputs Open OE = GND LE = V _{CC} One Bit Toggling 50% Duty Cycle	V _{IN} = V _{CC} V _{IN} = GND		0.15	0.25	mA/ MHz
I _C	Total Power Supply Current ⁽⁶⁾	V _{CC} = Max., Outputs Open f _i = 10 MHz 50% Duty Cycle OE = GND LE = V _{CC} One Bit Toggling	V _{IN} = V _{CC} V _{IN} = GND		1.5	3.0 ⁽⁵⁾	mA
			V _{IN} = 3.4V V _{IN} = GND		1.8	4.5 ⁽⁵⁾	
			V _{IN} = V _{CC} V _{IN} = GND		3.0	6.0 ⁽⁵⁾	
			V _{IN} = 3.4V V _{IN} = GND		5.0	14.0 ⁽⁵⁾	

Notes:

- For conditions shown as Max. or Min., use appropriate value specified under Electrical Characteristics for the applicable device.
- Typical values are at V_{CC} = 5.0V, +25°C ambient.
- Per TTL driven input (V_{IN} = 3.4V); all other inputs at V_{CC} or GND.
- This parameter is not directly testable, but is derived for use in Total Power Supply Calculations.
- Values for these conditions are examples of the I_{CC} formula. These limits are guaranteed but not tested.

$$6. I_C = I_{\text{QUIESCENT}} + I_{\text{INPUTS}} + I_{\text{DYNAMIC}}$$

$$I_C = I_{CC} + \Delta I_{CC} D_H N_T + I_{CCD} (f_{CP}/2 + f_i N_i)$$

I_{CC} = Quiescent Current

ΔI_{CC} = Power Supply Current for a TTL High Input (V_{IN} = 3.4V)

D_H = Duty Cycle for TTL Inputs High

N_T = Number of TTL Inputs at D_H

I_{CCD} = Dynamic Current Caused by an Input Transition Pair (HLH or LHL)

f_{CP} = Clock Frequency for Register Devices (Zero for Non-Register Devices)

f_i = Input Frequency

N_i = Number of Inputs at f_i

All currents are in milliamps and all frequencies are in megahertz.

PI74FCT373T Switching Characteristics over Operating Range

Parameters	Description	Conditions	373T		373AT		373CT		373DT		Unit
			Com.		Com.		Com.		Com.		
			Min	Max	Min	Max	Min	Max	Min	Max	
tPLH tPHL	Propagation Delay ⁽¹⁾ DN to ON	CL = 50 pF RL = 500Ω	1.5	8.0	1.5	5.2	1.5	4.2	1.5	3.8	ns
tPLH tPHL	Propagation Delay ⁽¹⁾ LE to ON		2.0	13.0	2.0	8.5	2.0	5.5	1.5	4.9	ns
tpZH tpZL	Output Enable Time OE to ON		1.5	12.0	1.5	6.5	1.5	5.5	1.5	5.5	ns
tpHZ tPLZ	Output Disable Time ⁽²⁾ OE to ON		1.5	7.5	1.5	5.5	1.5	5.0	1.5	5.0	ns
tsu	Setup Time HIGH or LOW, DN to LE		2.0		2.0		2.0		2.0		ns
th	Hold Time HIGH or LOW, DN to LE		1.5		1.5		1.5		1.5		ns
tw	LE Pulse Width ⁽²⁾ HIGH		6.0		5.0		5.0		4.0		ns

Notes:

1. Minimum limits are guaranteed but not tested on Propagation Delays.
2. This parameter guaranteed but not production tested.

PI74FCT573T Switching Characteristics over Operating Range

Parameters	Description	Conditions	573T		573AT		573CT		573DT		Unit
			Com.		Com.		Com.		Com.		
			Min	Max	Min	Max	Min	Max	Min	Max	
tPLH tPHL	Propagation Delay ⁽¹⁾ DN to ON	CL = 50 pF RL = 500Ω	1.5	8.0	1.5	5.2	1.5	4.2	1.5	3.8	ns
tPLH tPHL	Propagation Delay ⁽¹⁾ LE to ON		2.0	12.0	2.0	8.5	2.0	5.5	2.0	4.9	ns
tpZH tpZL	Output Enable Time OE to ON		1.5	9.5	1.5	6.5	1.5	5.5	1.5	5.5	ns
tpHZ tPLZ	Output Disable Time ⁽²⁾ OE to ON		1.5	6.5	1.5	5.5	1.5	5.0	1.5	5.0	ns
tsu	Setup Time HIGH or LOW, DN to LE		2.0		2.0		2.0		1.5		ns
th	Hold Time HIGH or LOW, DN to LE		1.5		1.5		1.5		1.0		ns
tw	LE Pulse Width ⁽²⁾ HIGH		6.0		5.0		5.0		3.0		ns

Notes:

1. Minimum limits are guaranteed but not tested on Propagation Delays.
2. This parameter guaranteed but not production tested.

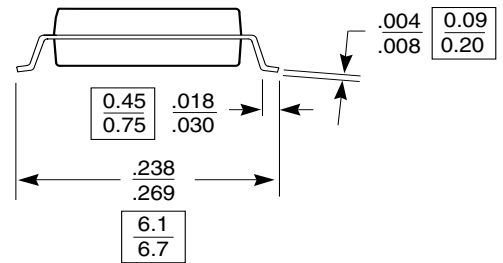
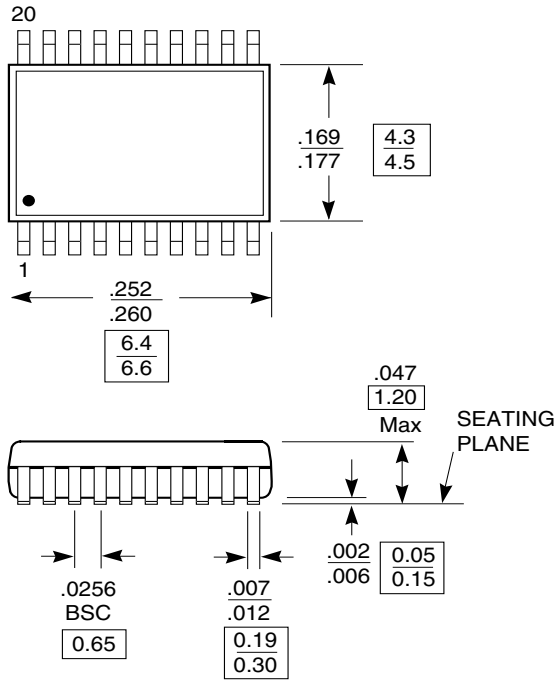
Packaging Mechanical: 20-Pin TSSOP (L)
**DOCUMENT CONTROL NO.
PD - 1311**
**REVISION: E
DATE: 03/09/05**

Note:

1. Package Outline Exclusive of Mold Flash and Metal Burr
2. Controlling dimensions in millimeters
3. Ref. JEDEC MO-153F/AC

**Pericom Semiconductor Corporation
3545 N. 1st Street, San Jose, CA 95134
1-800-435-2335 • www.pericom.com**
DESCRIPTION: 20-Pin, 173-Mil Wide, TSSOP
PACKAGE CODE: L

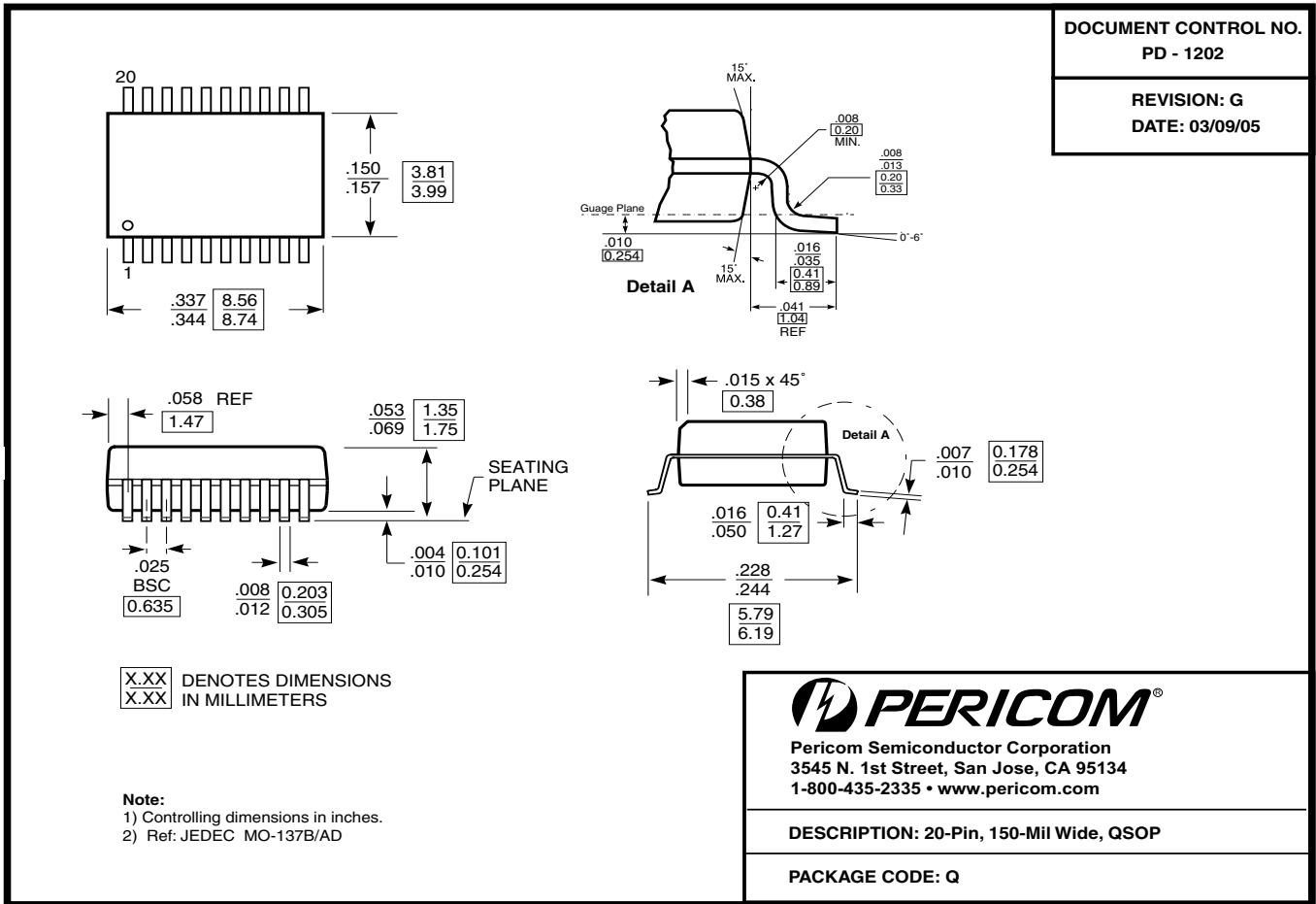
Packaging Mechanical: 20-pin QSOP (Q)

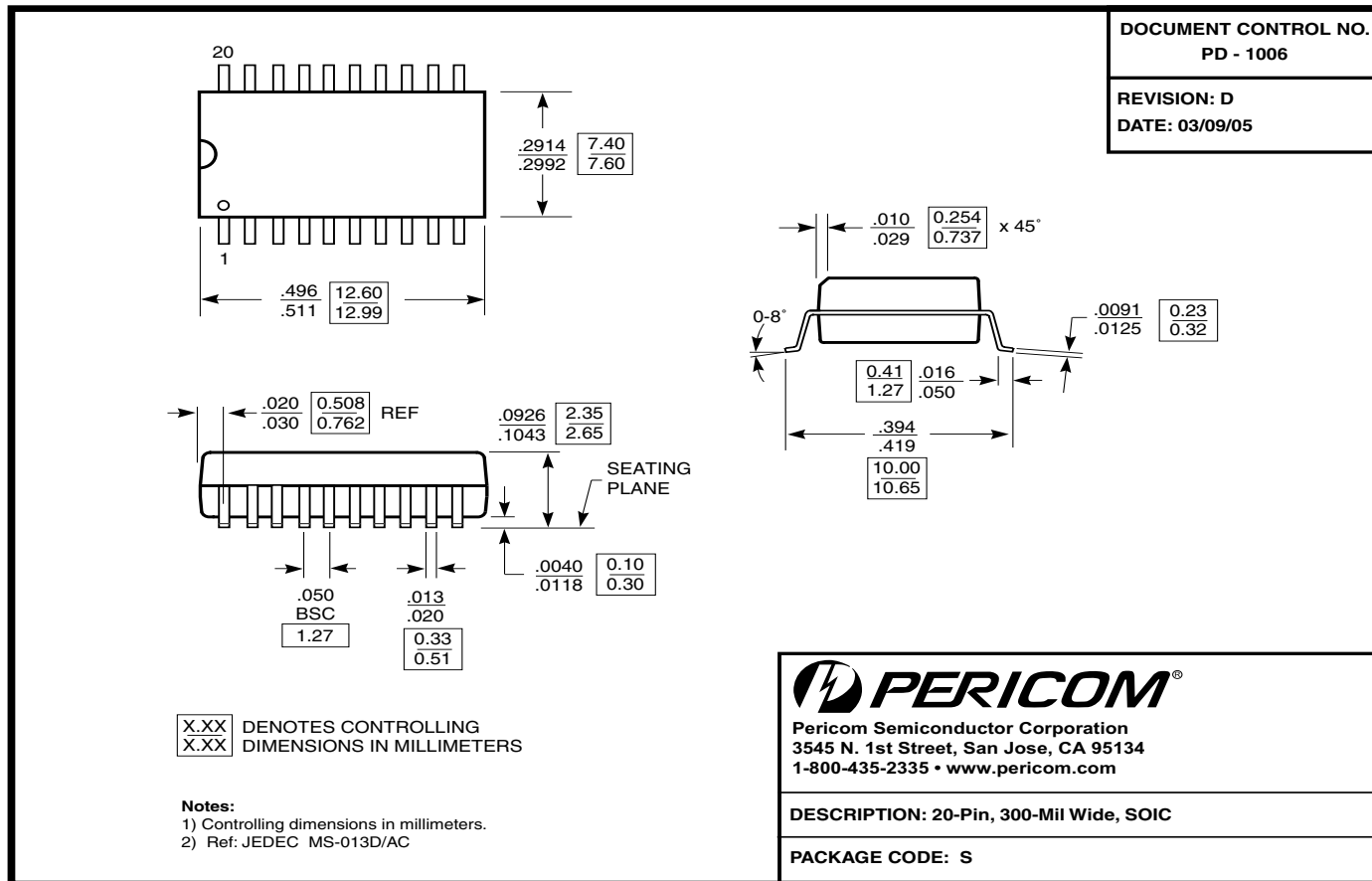

Packaging Mechanical: 20-pin SOIC (S)

PI74FCT373T Ordering Information

Ordering Code	Package Code	Speed Grade	Package Type
PI74FCT373TL	L	Blank	20-pin TSSOP
PI74FCT373TLE	L	Blank	Pb-free & Green, 20-pin TSSOP
PI74FCT373TQ	Q	Blank	20-pin QSOP
PI74FCT373TQE	Q	Blank	Pb-free & Green, 20-pin QSOP
PI74FCT373TS	S	Blank	20-pin SOIC
PI74FCT373TSE	S	Blank	Pb-free & Green, 20-pin SOIC
PI74FCT373ATQ	Q	A	20-pin QSOP
PI74FCT373ATQE	Q	A	Pb-free & Green, 20-pin QSOP
PI74FCT373CTL	L	C	20-pin TSSOP

PI74FCT573T Ordering Information

Ordering Code	Package Code	Speed Grade	Package Type
PI74FCT573TQ	Q	Blank	Pb-free & Green, 20-pin QSOP
PI74FCT573TS	S	Blank	20-pin SOIC
PI74FCT573TSE	S	Blank	Pb-free & Green, 20-pin SOIC
PI74FCT573ATS	S	A	20-pin SOIC
PI74FCT573ATSE	S	A	Pb-free & Green, 20-pin SOIC
PI74FCT573ATQ	Q	A	20-pin QSOP
PI74FCT573ATQE	Q	A	Pb-free & Green, 20-pin QSOP
PI74FCT573CTS	S	C	20-pin SOIC
PI74FCT573CTSE	S	C	Pb-free & Green, 20-pin SOIC
PI74FCT573CTQ	Q	C	20-pin QSOP
PI74FCT573CTQE	Q	C	Pb-free & Green, 20-pin QSOP
PI74FCT573DTQ	Q	D	20-pin QSOP
PI74FCT573DTQE	Q	D	Pb-free & Green, 20-pin QSOP

Notes:

- Thermal characteristics can be found on the company web site at www.pericom.com/packaging/
- E = Pb-free & Green
- Adding an X suffix = Tape/Reel

Part Marking Information

Pericom's standard product mark follows our standard part number ordering information, except for those products with a speed letter code. For marking purposes, the speed letter code mark is placed after the package code letter, rather than after the device number as it is ordered.

Although all products are marked immediately after assembly to assure material traceability, Pericom does not usually mark the speed code at that time. After electrical test screening and speed binning have been completed, we then perform an "add mark" operation which places the speed code letter at the end of the complete part number.

Please refer to the example shown below:

- Part Number as ordered: PI74FCT245ATQ
- Example of Part Number as marked:

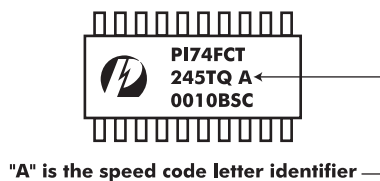
**Notes:**

- 1) 8-pin DIP, 8-pin SOIC, 8-pin TSSOP, 14-pin SOIC, 16-pin QSOP, SC70, MSOP, and SOT23 packages are not marked with the Pericom logo due to space limitations on the package.