

PQ1R30 Series

Low Output Current, Compact Surface Mount Type Low Power-Loss Voltage Regulators

Features

- Compact surface mount package (3.4 x 2.2 x 1.2mm)
- Low power-loss
(Dropout voltage: TYP.0.16V/MAX. 0.26V at $I_o=60\text{mA}$)
- High ripple rejection (TYP.55dB)
- Low current operation type
(Dissipation current at no load: TYP. 170 μA)
- Built-in ON/OFF control function
(Dissipation current at OFF-state: MAX. 0.1 μA)
- Overcurrent, overheat protection functions

Applications

- Cellular phones
- Cordless phones
- Personal information tools (PDA)
- Cameras/Camcoders
- PCMCIA cards for notebook PCs

Model Line-ups

Output Voltage	Model No.	Output Voltage	Model No.
2.2V	PQ1R22	3.4V	PQ1R34
2.5V	PQ1R25	3.6V	PQ1R36
2.7V	PQ1R27	3.8V	PQ1R38
2.8V	PQ1R28	4.0V	PQ1R40
2.9V	PQ1R29	4.7V	PQ1R47
3.0V	PQ1R30	4.9V	PQ1R49
3.1V	PQ1R31	5.0V	PQ1R50
3.3V	PQ1R33	5.2V	PQ1R52

* It is available for every 0.1V (1.8V to 5.5V)

Absolute Maximum Ratings

($T_a=25^\circ\text{C}$)

Parameter	Symbol	Rating	Unit
*1 Input voltage	V_{IN}	16	V
*1 ON/OFF control terminal voltage	V_c	16	V
Output current	I_o	240	mA
*2 Power dissipation	P_D	400	mW
*3 Junction temperature	T_j	150	$^\circ\text{C}$
Operating temperature	T_{opr}	-30 to +80	$^\circ\text{C}$
Storage temperature	T_{stg}	-55 to +150	$^\circ\text{C}$
Soldering temperature	T_{sol}	260 (For 10s)	$^\circ\text{C}$

*1 All are open except GND and applicable terminals.

*2 At mounted on PCB

*3 Overheat protection may operate at $125 \leq T_j \leq 150^\circ\text{C}$.

Outline Dimensions

(Unit : mm)

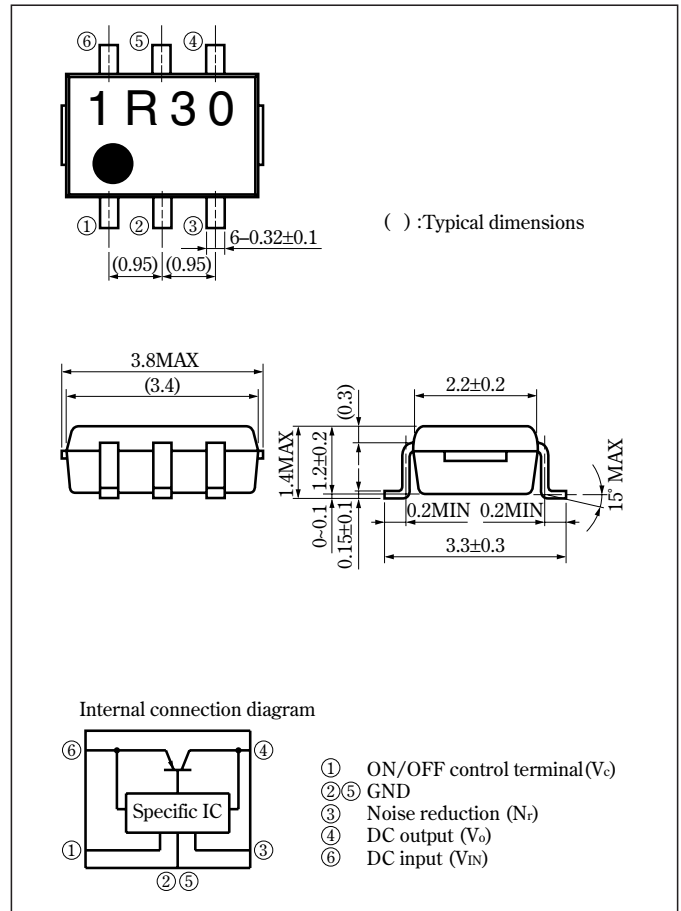

• Please refer to the chapter " Handling Precautions ".

SHARP

Notice In the absence of confirmation by device specification sheets, SHARP takes no responsibility for any defects that may occur in equipment using any SHARP devices shown in catalogs, data books, etc. Contact SHARP in order to obtain the latest device specification sheets before using any SHARP device.
Internet Internet address for Electronic Components Group <http://sharp-world.com/ecg/>

■ Electrical Characteristics

(Unless otherwise specified, *4 I_o=30mA, V_c=1.8V, T_a=25°C)

Parameter	Symbol	Conditions	MIN.	TYP.	MAX.	Unit
Output voltage	V _o	—	Refer to the following table.			V
Output current	I _o	*5	180	240	—	mA
Recommended output current	—	—	—	—	150	mA
Load regulation	R _{egL}	I _o =5mA to 60mA	—	10	50	mV
		I _o =5mA to 100mA	—	20	100	
		I _o =5mA to 150mA	—	40	160	
Line regulation	R _{egI}	V _i =V _o (TYP)+1V to V _o (TYP)+6V	—	3.0	20	mV
Temperature coefficient of output voltage	T _c V _o	I _o =10mA, T _j =-25 to +75°C	—	0.05	—	mV/°C
Ripple rejection	RR	—	—	55	—	dB
Output noise voltage	V _{no} (rms)	10Hz<f<100kHz, C _n =0.1μF, I _o =30mA	Refer to the following table.			μV
Dropout voltage	V _{i-o} (1)	I _o =60mA, *6	—	0.16	0.26	V
	V _{i-o} (2)	I _o =150mA, *6	—	0.29	0.4	
*7 ON-state voltage for control	V _c (ON)	—	1.8	—	—	V
ON-state current for control	I _c (ON)	V _c =1.8V	—	12	30	μA
OFF-state voltage for control	V _c (OFF)	—	—	—	0.6	V
Quiescent current	I _q	I _o =0mA	—	170	350	μA
Output OFF-state dissipation current	I _{qs}	V _{IN} =8V, V _c =0.4V	—	—	0.1	μA
Response time(Rise time)	T _r	I _o =30mA, V _c =0→1.8V	—	0.3	—	ms
Noise control terminal voltage	—	—	—	1.25	—	V

*4 V_{IN}=V_o(TYP)+1.0V

*5 Output current shall be the value when output voltage lowers 0.3V from the voltage at I_o=30mA.

*6 Dropout voltage when output voltage lowers 5% from the voltage at V_{IN}=V_o+1V.

*7 In case that the control terminal ① is non-connection, output voltage should be OFF-state.

*8 In case of PQ1R13, PQ1R15, PQ1R18, V_{IN} minimum=2.3V

■ Output Voltage Line-ups

(V_{IN}=V_o(TYP)+1.0V, I_o=30mA, V_c=1.8V, T_a=25°C)

Model No.	Symbol	MIN.	TYP.	MAX.	Unit
PQ1R13	V _o	1.220	1.3	1.380	V
PQ1R15		1.420	1.5	1.580	
PQ1R18		1.720	1.8	1.800	
PQ1R22		2.120	2.2	2.280	
PQ1R25		2.420	2.5	2.580	
PQ1R27		2.620	2.7	2.780	
PQ1R28		2.720	2.8	2.880	
PQ1R29		2.820	2.9	2.980	
PQ1R30		2.920	3.0	3.080	
PQ1R31		3.020	3.1	3.180	
PQ1R32		3.120	3.2	3.280	
PQ1R33		3.215	3.3	3.385	
PQ1R34		3.315	3.4	3.485	
PQ1R35		3.410	3.5	3.590	
PQ1R36		3.510	3.6	3.690	
PQ1R37		3.605	3.7	3.795	
PQ1R38		3.705	3.8	3.895	
PQ1R40		3.900	4.0	4.100	
PQ1R42		4.095	4.2	4.305	
PQ1R47		4.580	4.7	4.820	
PQ1R49	4.775	4.9	5.025		
PQ1R50	4.875	5.0	5.125		
PQ1R52	5.070	5.2	5.330		

■ Output Noise Voltage Line-ups

(V_{IN}=V_o(TYP)+1.0V, I_o=30mA, V_c=1.8V, C_n=0.1μF, 10Hz<f<100kHz, T_a=25°C)

Model No.	Symbol	MIN.	TYP.	MAX.	Unit
PQ1R13	V _{no} (rms)	—	15	—	μV
PQ1R15		—	30	—	
PQ1R18		—	15	—	
PQ1R22		—	20	—	
PQ1R25		—	25	—	
PQ1R27		—	25	—	
PQ1R28		—	25	—	
PQ1R29		—	25	—	
PQ1R30		—	30	—	
PQ1R31		—	30	—	
PQ1R32		—	30	—	
PQ1R33		—	30	—	
PQ1R34		—	30	—	
PQ1R35		—	40	—	
PQ1R36		—	35	—	
PQ1R37		—	30	—	
PQ1R38		—	35	—	
PQ1R40		—	40	—	
PQ1R42		—	30	—	
PQ1R47		—	45	—	
PQ1R49	—	45	—		
PQ1R50	—	50	—		
PQ1R52	—	50	—		

Fig. 1 Test Circuit

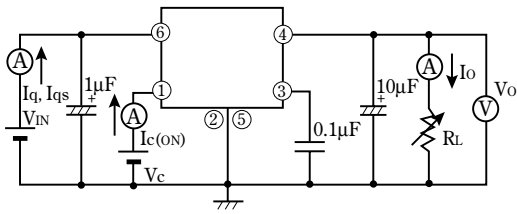
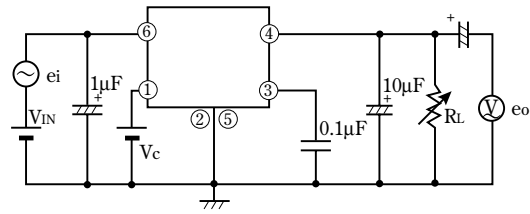
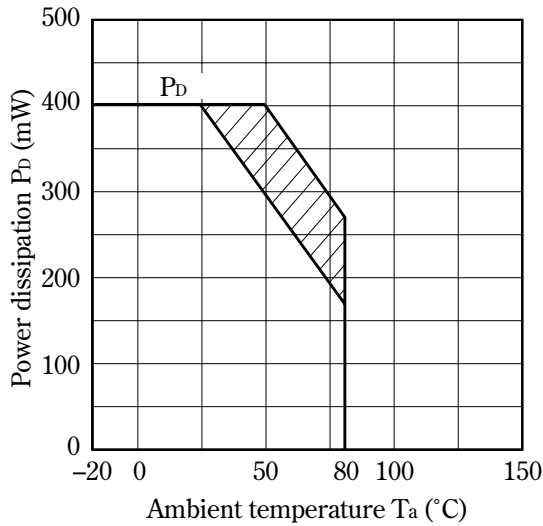

Fig. 2 Test Circuit of Ripple Rejection



$f=400\text{Hz (sine wave)}$
 $e_{i(\text{rms})}=100\text{mV}$
 $V_{\text{IN}}=V_{\text{O (TYP)}}+1.0\text{V}$
 $I_{\text{O}}=10\text{mA}$
 $RR=20 \log(e_{i(\text{rms})}/e_{o(\text{rms})})$

Fig. 3 Power Dissipation vs. Ambient Temperature



Note) Oblique line portion : Overheat protection may operate in this area.

Fig. 4 Overcurrent Protection Characteristics (Typical Value)

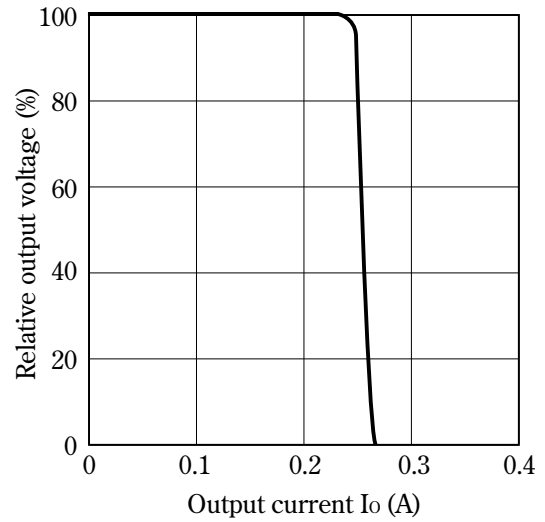

Note) Oblique line portion : Overheat protection may operate in this area.

Fig. 5 Output Voltage Deviation vs. Junction Temperature (PQ1R30) (Typical Value)

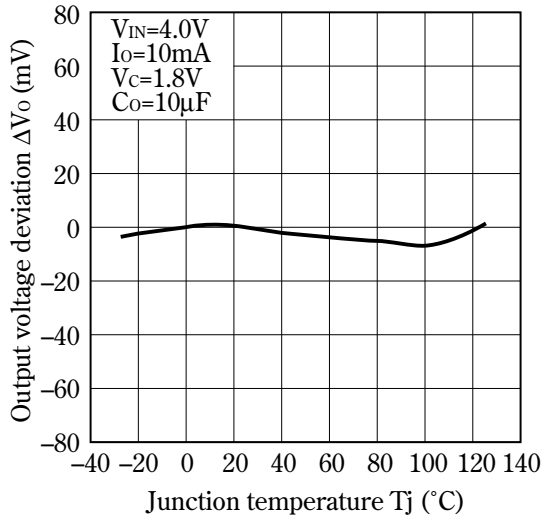

Fig. 6 Output Voltage vs. Input Voltage (PQ1R30) (Typical Value)

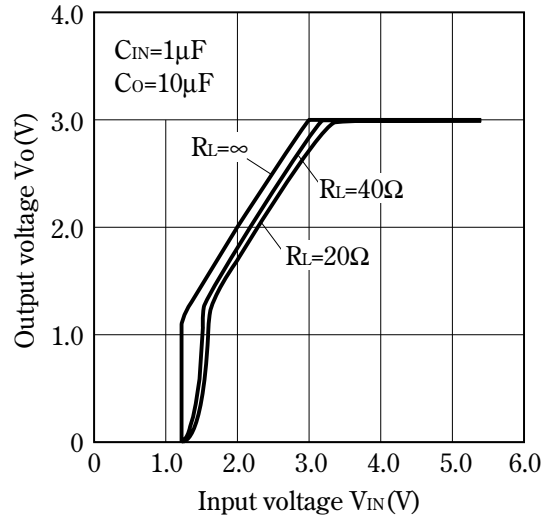

Fig. 7 Circuit Operating Current vs. Input Voltage (PQ1R30) (Typical Value)

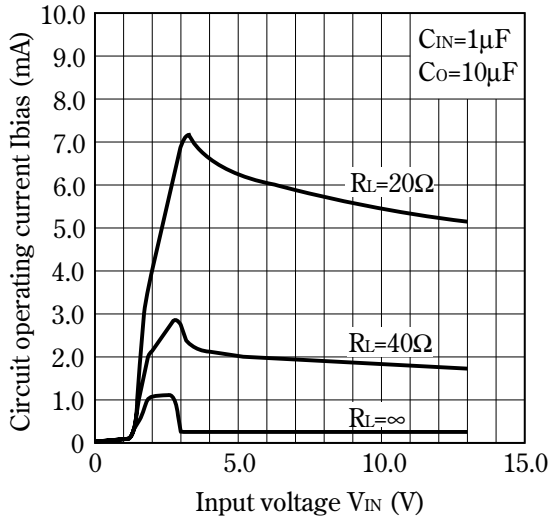

Fig. 8 Dropout Voltage vs. Junction Temperature (PQ1R30) (Typical Value)

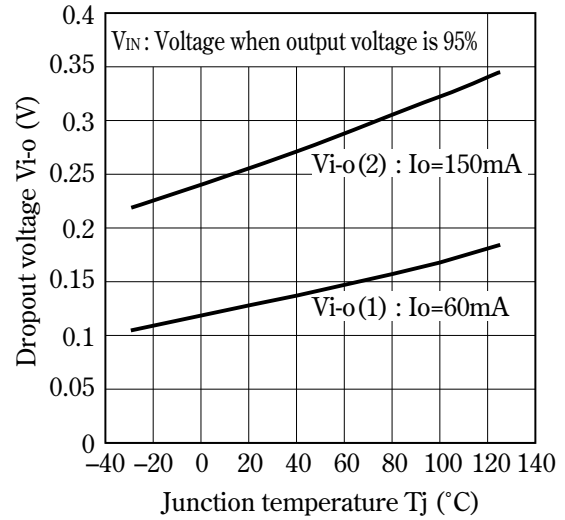

Fig. 9 Quiescent Current vs. Junction Temperature

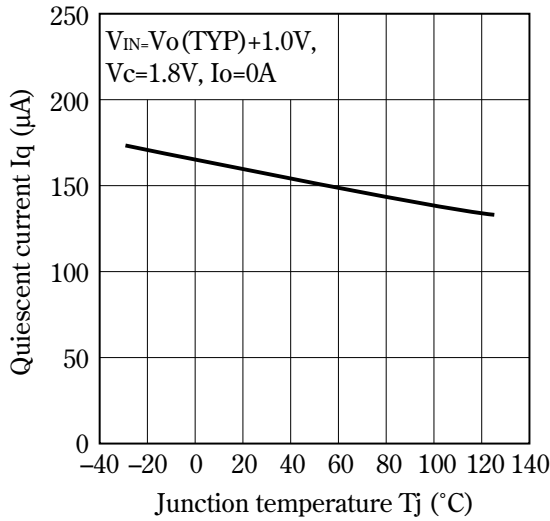

Fig.10 Ripple Rejection vs. Input Ripple Frequency

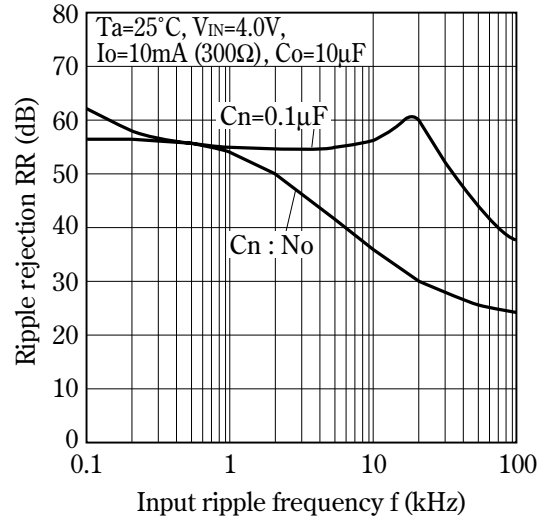

Fig.11 Dropout Voltage vs. Output Current

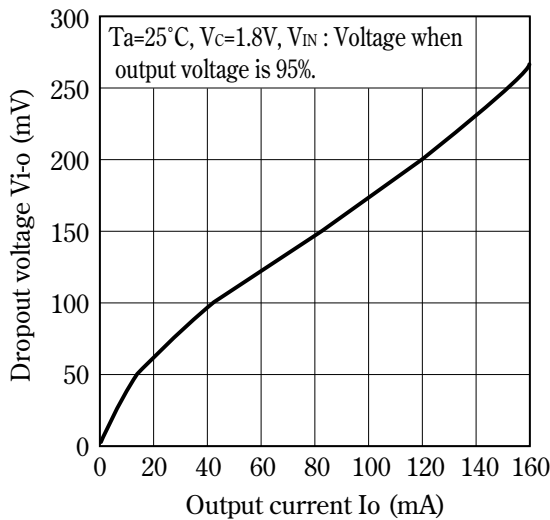
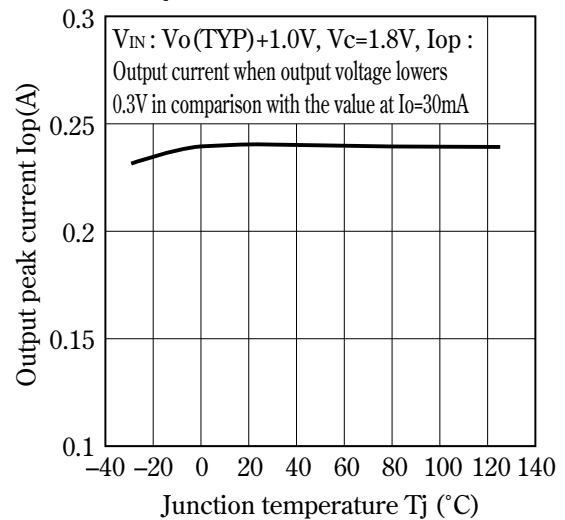
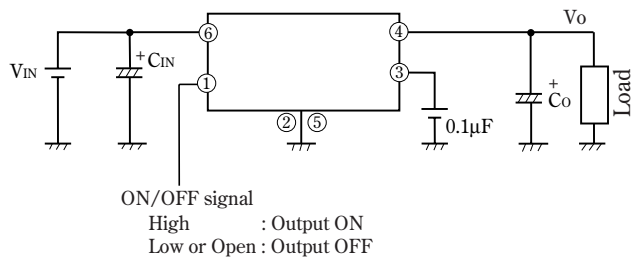

Fig.12 Output Peak Current vs. Junction Temperature



■ ON/OFF Operation



NOTICE

- The circuit application examples in this publication are provided to explain representative applications of SHARP devices and are not intended to guarantee any circuit design or license any intellectual property rights. SHARP takes no responsibility for any problems related to any intellectual property right of a third party resulting from the use of SHARP's devices.
- Contact SHARP in order to obtain the latest device specification sheets before using any SHARP device. SHARP reserves the right to make changes in the specifications, characteristics, data, materials, structure, and other contents described herein at any time without notice in order to improve design or reliability. Manufacturing locations are also subject to change without notice.
- Observe the following points when using any devices in this publication. SHARP takes no responsibility for damage caused by improper use of the devices which does not meet the conditions and absolute maximum ratings to be used specified in the relevant specification sheet nor meet the following conditions:
 - (i) The devices in this publication are designed for use in general electronic equipment designs such as:
 - Personal computers
 - Office automation equipment
 - Telecommunication equipment [terminal]
 - Test and measurement equipment
 - Industrial control
 - Audio visual equipment
 - Consumer electronics
 - (ii) Measures such as fail-safe function and redundant design should be taken to ensure reliability and safety when SHARP devices are used for or in connection with equipment that requires higher reliability such as:
 - Transportation control and safety equipment (i.e., aircraft, trains, automobiles, etc.)
 - Traffic signals
 - Gas leakage sensor breakers
 - Alarm equipment
 - Various safety devices, etc.
 - (iii) SHARP devices shall not be used for or in connection with equipment that requires an extremely high level of reliability and safety such as:
 - Space applications
 - Telecommunication equipment [trunk lines]
 - Nuclear power control equipment
 - Medical and other life support equipment (e.g., scuba).
- If the SHARP devices listed in this publication fall within the scope of strategic products described in the Foreign Exchange and Foreign Trade Law of Japan, it is necessary to obtain approval to export such SHARP devices.
- This publication is the proprietary product of SHARP and is copyrighted, with all rights reserved. Under the copyright laws, no part of this publication may be reproduced or transmitted in any form or by any means, electronic or mechanical, for any purpose, in whole or in part, without the express written permission of SHARP. Express written permission is also required before any use of this publication may be made by a third party.
- Contact and consult with a SHARP representative if there are any questions about the contents of this publication.