

GN series



1x RS232, 1x RS485 (optional)



TFT display, 256k colors



2x LAN 10/100/1000 Base-T



CF memory card slot



2x USB rear, 1x USB front (except GN07)



Microsoft Windows CE 6.0

Product lineup



	GN07	GN10	GN12	GN15
Display size (W x H in mm)	7" 152.4 x 91.44	10.4" 211.2 x 158.4	12.1" 246.0 x 184.5	15" 304.1 x 228.1
Display type	TFT, 256k color	TFT, 256k color	TFT, 256k color	TFT, 16.2M color
Brightness	330 cd/m ²	230 cd/m ²	400 cd/m ²	350 cd/m ²
Resolution (W x H)	800x480 dots	800x600 dots	800x600 dots	1024x768 dots
Processor	Intel® Atom™ N270 1.6 GHz			
RAM	512 MB			
User memory	Depends on size of CF card			
RS232	✓	✓	✓	✓
RS485 (422)	Optional			
LAN	2x 10/100/1000 Base-T	2x 10/100/1000 Base-T	2x 10/100/1000 Base-T	2x 10/100/1000 Base-T
USB	2x rear -	2x rear, 1x front	2x rear, 1x front	2x rear, 1x front
Fieldbus*	Optional			

*planned 2010

GN series

Features

■ Extreme vividness

Embedded in an elegant black frame, the TFT screens offer a brilliant, vivid and life-like display in 262,144 colors. The GN series boasts an IP65 degree of protection from the front, and its analog resistance screen responds flawlessly to the touch.

With a resolution of up to 1024x768 pixels and a brightness of 400cd/m²(max.), you will never be left in the dark.



■ Alarm management

The powerful alarm management guarantees maximum precision in managing events. Alarm management supports the 4 standard operating states (ON, OFF, ACK, RST) according to the ISA S-18 standard, but they can be easily changed individually according to your needs (events, colors, representations) and give custom help and be set by defined conditions.

■ Installed Movicon CE Runtime

Panels are ready to use with a preinstalled and activated Runtime.

■ Data logging and recipe

By using the same recording techniques, recipes and data loggers are stored in text files (.dat, .xml or encrypted files) with IMDB technology (InMemory DB). By using objects and wizards, the handling of recipe objects is much easier than with traditional methods.

■ Broad spectrum of applications

The GN series lends itself to a broad spectrum of applications. In addition to the basic features for recipe management, alarm management and multi-language, the GN series also provides all necessary hardware to support logging data.

If your application requires an HMI between 7" and 15", Panasonic's GN series is the right answer.



■ Myriad communication interfaces

The GN series was designed to leave no wish unfulfilled. In addition to the wide range of standard interfaces, optional networking interfaces are available.

Standard interfaces:

1x R232
2x USB rear, 1x USB front (except GN07)
2x LAN 10/100/1000 Base-T

Optional interfaces:

1x RS485
Fieldbus interfaces
(planned: PROFIBUS, CANopen)

As Ethernet becomes more and more popular in factory automation worldwide, the GN series comes equipped with 2 Ethernet ports, allowing you to take advantage of the IT world.

- Use existing networks, save wiring
- Reach almost every point of the world via Internet
- Standard software tools already existing on your PC
- Remote control, monitoring and programming

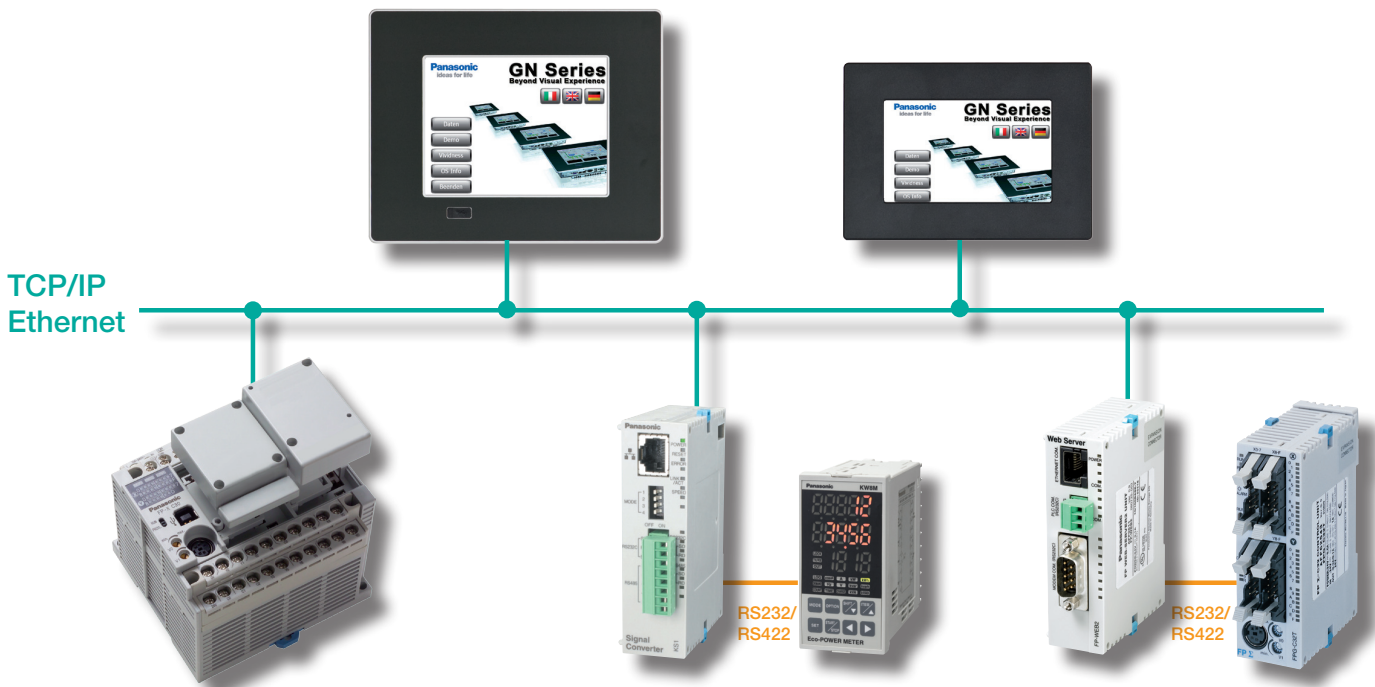

GN07

Compact

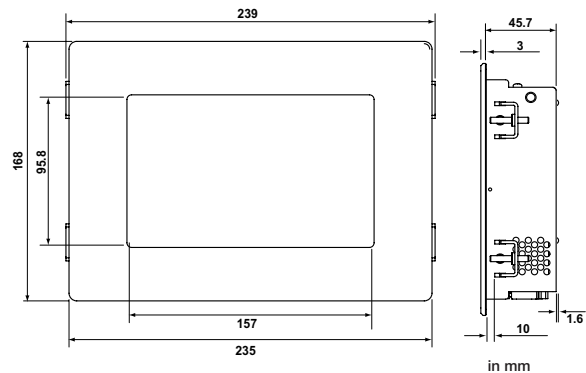

■ Compact and powerful

The GN series is available in 4 sizes, from 7" to 15". The smallest member of this series is the GN07. Due to its compact size, this panel can be used in places where little space is available but where emphasis is nevertheless placed on performance. Regarding performance capability, the GN07 boasts the same works as its big brothers and can do everything they can.

- 7.0" TFT display
- 256k colors
- Resolution: 800x480 pixels
- installed Movicon CE Runtime



■ For tight fits

Sometimes there's simply not enough space for a large HMI. There can be many reasons for this. Nevertheless, the application may require a powerful and flexible HMI. With the same inner works as the other models in the GN series, the GN07 is the perfect solution for such cases.

Its many interfaces provide for flexibility, all included in a compact housing that allow it to score under such circumstances.

GN10

Flexibility

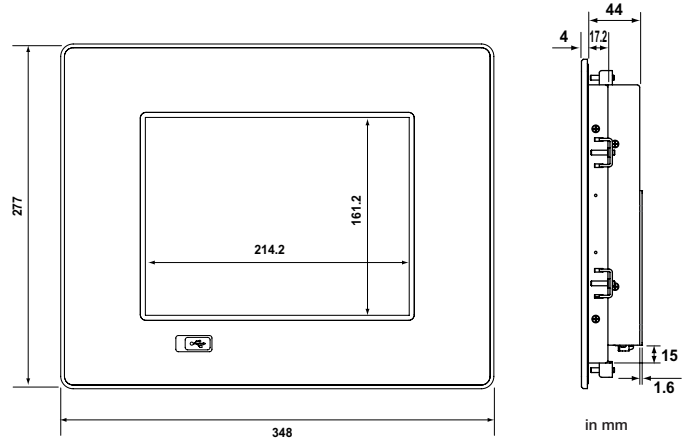

■ Open and flexible

Just like all other GN series touch panels, the GN10 is equipped with numerous interfaces. GN10 also provides a number of configurations and can accommodate a broad spectrum of application areas. Devices can be adapted to individual needs, if need be by request, from being equipped with serial interfaces to having a selection of fieldbus networks.

- 10.4" TFT display
- 256k colors
- Resolution: 800x600 pixels
- installed Modicon CE Runtime

■ Application example: telecontrol and remote maintenance

Data transmission in both the command and reporting directions plays a central role in making the right decisions when certain events occur, for example in water treatment applications.

In the event of a failure, the pass-through mode not only allows HMI data to be analyzed but can also simultaneously activate the diagnostic mode on the PLC, for example, without requiring the outstation to be directly connected to the PLC.

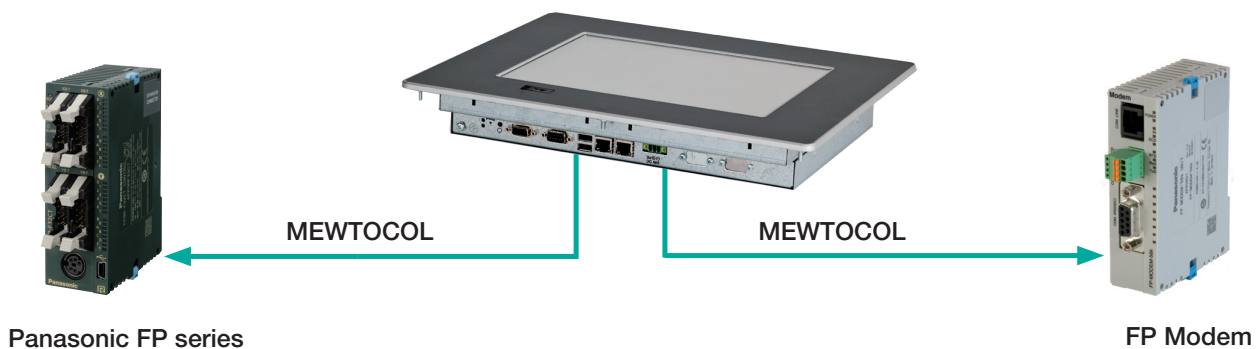

GN12

One big foot

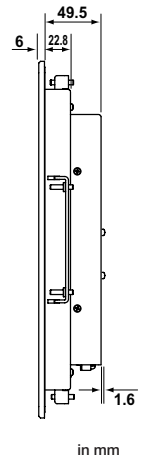
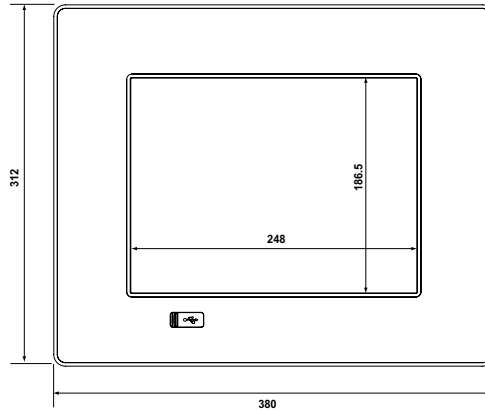

■ Data logging and alarm management

are extremely important for many applications.

As with all other GN series touch panels, the GN12 offers a CF card slot. History data can be stored on the CF card. Data is registered and recipes are archived as text files using "IMDB" technology, or in relational databases.

- 12.1" TFT display
- 256k colors
- Resolution: 800x600 pixels
- installed Movicon CE Runtime

■ Application example: gateway

Depending on the application area and requirements, very different communication protocols are used in machines and industrial systems. When systems or machines are expanded, problems can quickly arise. The GN series touch panels not only provide a powerful HMI, they also provide a gateway that allows networks to communicate with each other. Communicate without hurdles.

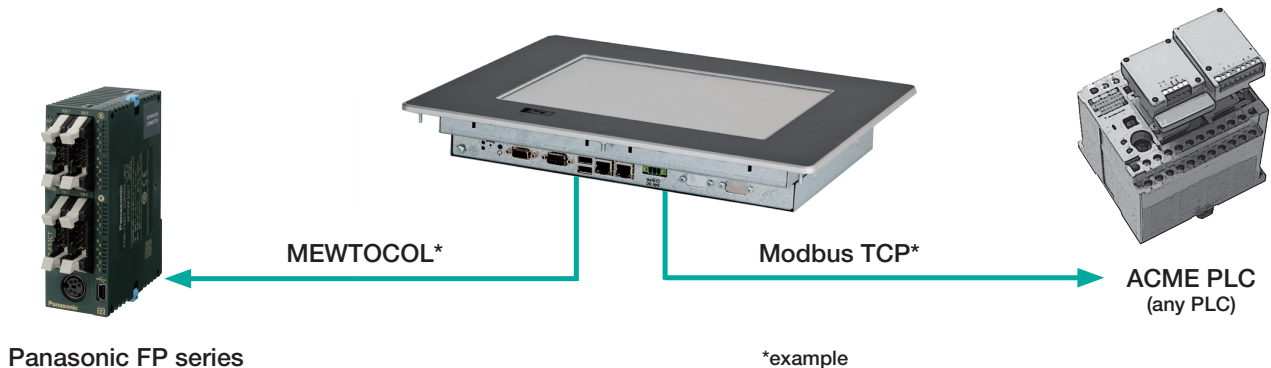

GN15

Big screen

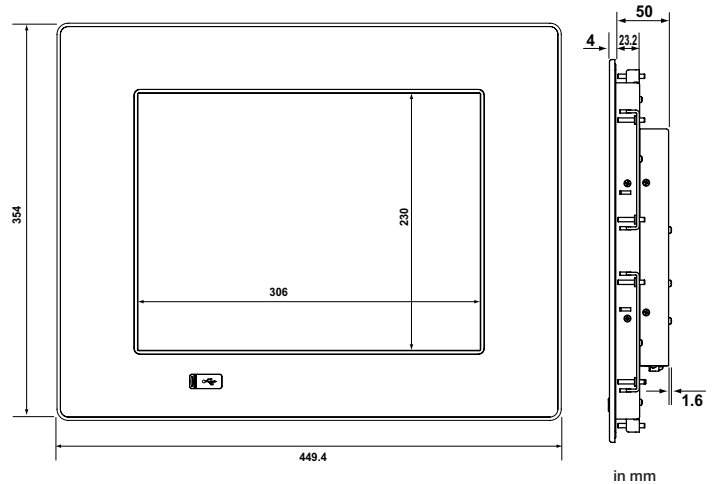

■ When size matters

Our largest model, the GN15, is the perfect choice when a lot of information requires a superior display. 16.2 million colors and a brightness of 350 cd/m² make for a convincing display. Should questions arise while using the panel, the integrated viewer can call up the corresponding help files.

1024 security levels and 16 entry areas make sure information is only available to those for whom it is intended.

- 15.0" TFT display
- 16.2M color
- Resolution: 1024x768 pixels
- installed Movicon CE Runtime

■ Visualizing vast amounts of data

Precise data collection as well as an exact and clear display are indispensable in order to react quickly to changes in an application. With the largest HMI of the GN series, you can arrange numerous screens and large amounts of data clearly and in a structured manner.

You can also integrate external programs into the visualization by using the interfaces available.







GN series

Specifications / dimensions

GN series		GN07	GN10	GN12	GN15
TFT LCD Display	Screen size Active area (W x H) [mm]	7"	10.4"	12.1"	15"
	Resolution (W x H) [pixel]	800 x 480	800 x 600 (SVGA)	800 x 600 (SVGA)	1024 x 768 (XGA)
	Pixel pitch (W x H) [mm]	0.1905 x 0.1905	0.264 x 0.264	0.3075 x 0.3075	0.297 x 0.297
	Color depth	256k			16.2M
	Backlight	LED	1 x CCFL	2 x CCFL	
	Brightness cd/m ²	330	230	400	350
	Control signal	1x 6bit LVDS			
	Viewing angle (°) (r / l / u / d)	60 / 60 / 40 / 55	70 / 70 / 55 / 65	70 / 70 / 50 / 60	70 / 70 / 65 / 60
Contrast ratio	400:1	500:1	500:1	700:1	
Touch screen	4-wire resistive analog				
Processor	Intel® Atom™ processor N270 1.6GHz				
Battery	Lithium battery 3.0V for real-time clock. Type CR2032, UL-listed				
Power supply input	12VDC (2.8A max.) to 24VDC (1.8A max.) ±10%				
USB 2.0 interface	2x	3x			
Ethernet interface (10/100/1000Mbps) (LAN0, LAN1)	2x				
VGA interface	1x				
Serial RS232 interface (COM1)	1x				
Protection class	IP65 (front side)				
Optional interfaces	<ul style="list-style-type: none"> • Serial RS422/485 • Serial RS232 • Industrial fieldbus • Industrial Ethernet (not GN07) 				
Power LED (PWR)	Yes				
Reset button (RESET)	Yes				
Mini PCIexpress slot	Yes				
Compact flash card slot	1x				
Storage media	CF card				
BIOS	Phoenix/Phoenix-Award				
Operating system	Standard: Windows CE				
DC power connector (3 pin)	(Other operating systems available upon request)				
DC power plug (3 pin)	1x				
Mounting clamps	4x (1 screw)	8x (1 screw)	6x (2 screws)	8x (2 screws)	

GN series

Part numbers

Product		Description				Part number
		Type	Operation system	Visualization runtime	Serial interface	
	GN07 series	GN07	WIN CE 6.0	Movicon CE	RS232C	AIGN07M232
			WIN CE 6.0	without	RS485	AIGN07M485
	GN10 series	GN10	WIN CE 6.0	Movicon CE	RS232C	AIGN10M232
			WIN CE 6.0	without	RS485	AIGN10M485
	GN12 series	GN12	WIN CE 6.0	Movicon CE	RS232C	AIGN12M232
			WIN CE 6.0	without	RS485	AIGN12M485
	GN15 series	GN15	WIN CE 6.0	Movicon CE	RS232C	AIGN15M232
			WIN CE 6.0	without	RS485	AIGN15M485
	Movicon Development tool	Software	—	—	—	AIGNDEVPRG

*on request
fieldbus planned for 2010

■ Screen data transmission cable

GN series COM1-> FP series
tool port (3m)
Part no.: **AFC8513**



GN series

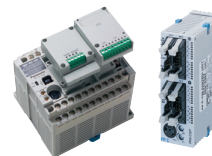

Panasonic Electric Works FP series

GN series COM1 -> FP2 COM
Part no.: **AIP81862E1D**



GN series

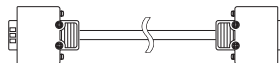

Panasonic Electric Works FP2/MCU RS232

GN COM1 (RS232) -> loose
wire (2.90m)
Part no.: **AIGNCAB232**

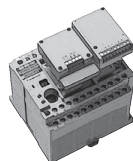

any PLC

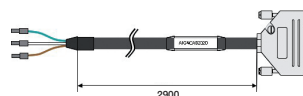

GN series