

Twin type (8 terminals)

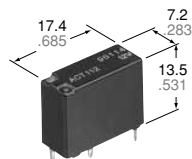

mm inch

Slim 1c type

Compliance with RoHS Directive

FEATURES

- **Small & slim size**

Twin type: 17.4(L)×14.0(W)×13.5(H)mm

.685(L)×.551(W)×.531(H)inch

Slim 1c type: 17.4(L)×7.2(W)×13.5(H)mm

.685(L)×.283(W)×.531(H)inch

- **Twin (1 Form C × 2)**

Forward/reverse motor control is possible with a single relay.

- **Simple footprint enables ease of PC board layout**

※ 10 terminals layout

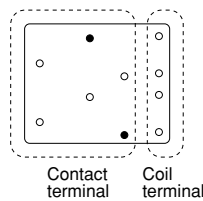

o = 8 terminals

TYPICAL APPLICATIONS

- Power windows
- Auto door lock
- Power sunroof
- Electrically powered mirrors
- Powered seats
- Lift gates
- Slide door closers, etc.
(for DC motor forward/reverse control circuits)

SPECIFICATIONS

Contact

Arrangement	1 Form C×2, 1 Form C		
Contact material	Ag alloy (Cadmium free)		
Initial contact resistance (Initial) (By voltage drop 6 V DC 1 A)	Typ. 7 mΩ (N.O.) Typ. 10 mΩ (N.C.)		
Rating	Nominal switching capacity	N.O.: 20 A 14 V DC N.C.: 10 A 14 V DC	
	Max. carrying current (N.O.)	35 A for 2 minutes, 25 A for 1 hour (14 V, at 20°C 68°F) 30 A for 2 minutes, 20 A for 1 hour (14 V, at 85°C 185°F)	
	Min. switching capacity#1	1 A 12 V DC	
Expected life (min. operation)	Mechanical (at 120 cpm)	Min. 10 ⁷	
	Electrical	Resistive load	Min. 10 ⁵ *1
		Motor load	Min. 2×10 ⁵ *2 (free) Min. 10 ⁵ *3 (lock)

Coil

Nominal operating power	800 mW
-------------------------	--------

#1 This value can change due to the switching frequency, environmental conditions, and desired reliability level, therefore it is recommended to check this with the actual load.

Remarks

*1 At nominal switching capacity, operating frequency: 1s ON, 9s OFF

*2 N.O.: at 5 A (steady), 25 A (inrush)/N.C.: at 20 A (brake) 14 V DC, operating frequency: 0.5s ON, 9.5s OFF

*3 At 25A 14 V DC (Motor lock), operating frequency: 0.5s ON, 9.5s OFF

*4 Measurement at same location as "Initial breakdown voltage" section

*5 Detection current: 10mA

*6 Excluding contact bounce time

*7 Half-wave pulse of sine wave: 11ms; detection: 10μs

*8 Half-wave pulse of sine wave: 6ms

*9 Detection time: 10μs

Characteristics

Max. operating speed (at nominal switching capacity)	6 cpm	
Initial insulation resistance*4	Min. 100 MΩ (at 500 V DC)	
Initial breakdown voltage*5	Between open contacts	500 Vrms for 1 min.
	Between contacts and coil	500 Vrms for 1 min.
Operate time*6 (at nominal voltage) (at 20°C 68° F)	Max. 10ms (Initial)	
Release time*6 (at nominal voltage) (at 20°C 68° F)	Max. 10ms (Initial)	
Shock resistance	Functional*7	Min. 100 m/s ² {10G}
	Destructive*8	Min. 1,000 m/s ² {100G}
Vibration resistance	Functional*9	10 Hz to 100 Hz, Min. 44.1m/s ² {4.5G}
	Destructive*10	10 Hz to 500 Hz, Min. 44.1m/s ² {4.5G}
Conditions for operation, transport and storage*11 (Not freezing and condensing at low temperature)	Ambient temp	-40°C to +85°C -40°F to +185°F
	Humidity	5% R.H. to 85% R.H.
Mass	Approx. 8.0g .28oz (Twin type) Approx. 4.0g .14oz (Slim 1c type)	

*10 Time of vibration for each direction;

X, Y, direction: 2 hours
Z direction: 4 hours



*11 Refer to Conditions for operation, transport and storage mentioned in AMBIENT ENVIRONMENT .

Please inquire if you will be using the relay in a high temperature atmosphere (110°C 230°F).

* If the relay is used continuously for long periods of time with coils on both sides in an energized condition, breakdown might occur due to abnormal heating depending on the carrying condition. Therefore, please inquire when using with a circuit that causes an energized condition on both sides simultaneously.

CT (ACT)

ORDERING INFORMATION

Ex. A CT 1 12

Product name	Contact arrangement	Coil voltage (V DC)
CT	1: 1 Form C 2: 1 Form C × 2 (8 terminals type) 5: 1 Form C × 2 (10 terminals type)	12: 12

Standard packing; 1 Form C: Carton(tube package) 30pcs. Case 1,500pcs.
1 Form C × 2: Carton(tube package) 30pcs. Case 900pcs.

TYPES AND COIL DATA (at 20°C 68°F)

Contact arrangement	Part No.	Nominal voltage, V DC	Pick-up voltage, V DC (Initial)	Drop-out voltage, V DC (Initial)	Coil resistance, Ω	Nominal operating current, mA	Nominal operating power, mW	Usable voltage range, V DC
1c	ACT112	12	Max. 7.2	Min. 1.0	180±10%	66.7±10%	800	10 to 16
1c × 2 (8 terminals type)	ACT212	12	Max. 7.2	Min. 1.0	180±10%	66.7±10%	800	10 to 16
1c × 2 (10 terminals type)	ACT512	12	Max. 7.2	Min. 1.0	180±10%	66.7±10%	800	10 to 16

* Other pick-up voltage types are also available. Please contact us for details.

DIMENSIONS

1. Twin type (8 terminals)

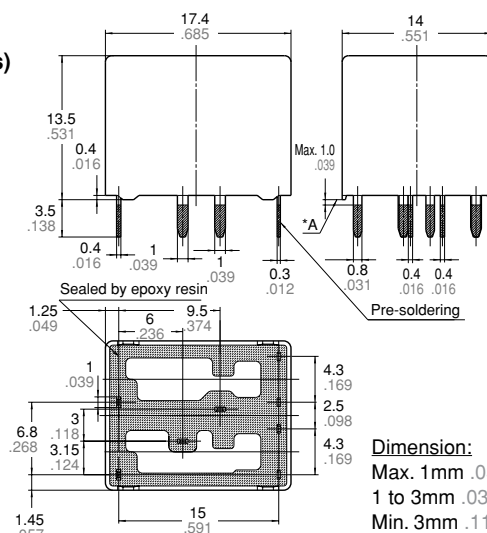

mm inch

PC board pattern (Bottom view)

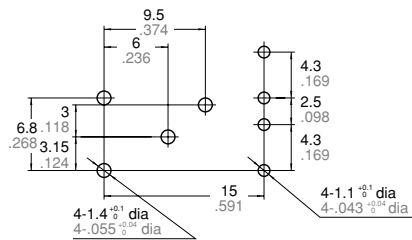

Tolerance: ±0.1 ±0.04

Schematic (Bottom view)

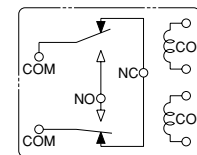

* Dimensions (thickness and width) of terminal specified in this catalog is measured before pre-soldering. Intervals between terminals is measured at A surface level.

2. Twin type (10 terminals)

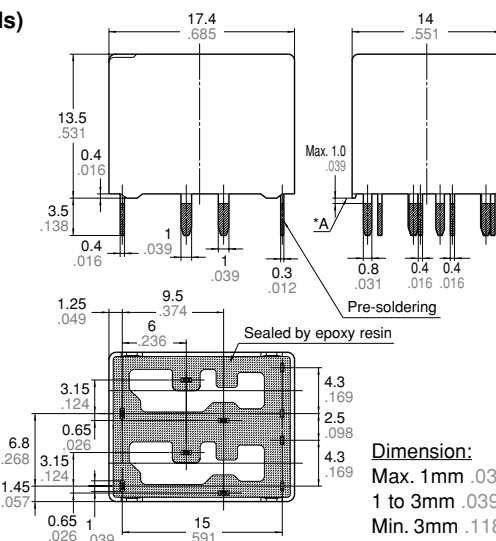

PC board pattern (Bottom view)

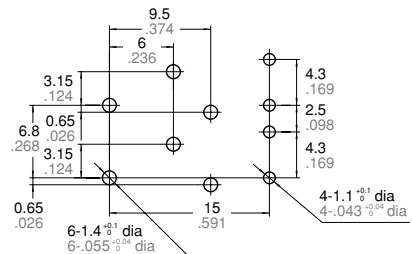

Tolerance: ±0.1 ±0.04

Schematic (Bottom view)

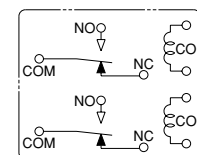

* Dimensions (thickness and width) of terminal specified in this catalog is measured before pre-soldering. Intervals between terminals is measured at A surface level.

3. Slim 1c type

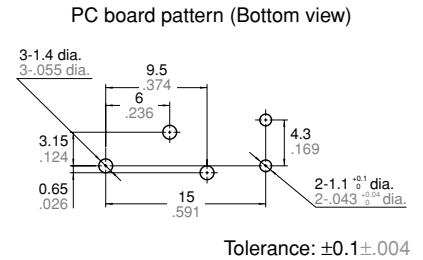
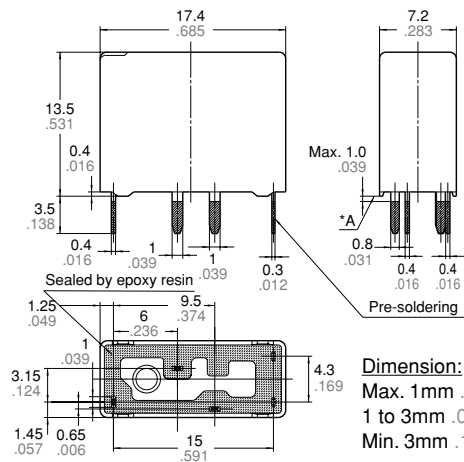

Schematic (Bottom view)

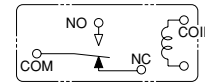

Dimension	Tolerance
Max. 1mm .039 inch:	±0.1 ±.004
1 to 3mm .039 to .118 inch:	±0.2 ±.008
Min. 3mm .118 inch:	±0.3 ±.012

* Dimensions (thickness and width) of terminal specified in this catalog is measured before pre-soldering. Intervals between terminals is measured at A surface level.

EXAMPLE OF CIRCUIT

Forward/reverse control circuits of DC motor for power windows

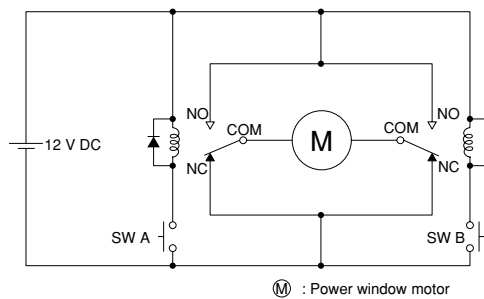

(M) : Power window motor

REFERENCE DATA

1-(1). Coil temperature rise (at room temperature)
Sample: ACT212, 3pcs.
Contact carrying current: 0A, 10A, 20A

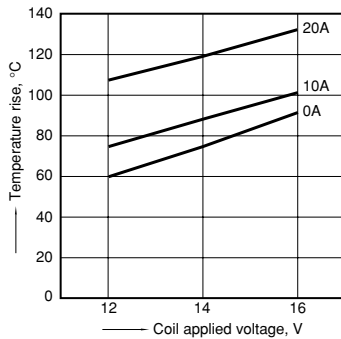

1-(2). Coil temperature rise (at 85°C 185°F)
Sample: ACT212, 3pcs.
Contact carrying current: 0A, 10A, 20A

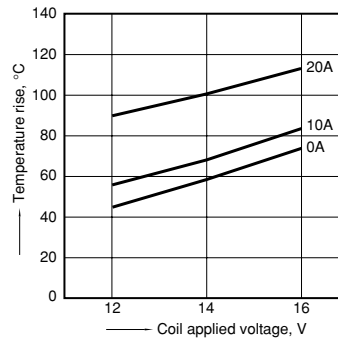

2. Max. switching capability (Resistive load, initial)

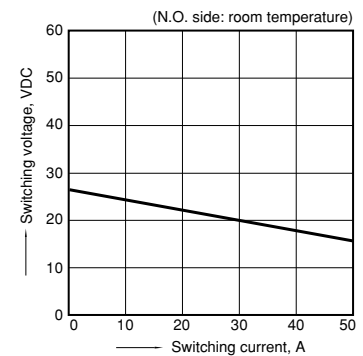

3. Ambient temperature and operating voltage range

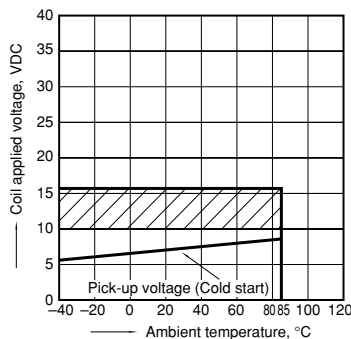

4. Distribution of pick-up and drop-out voltage
Sample: ACT212, 40pcs.

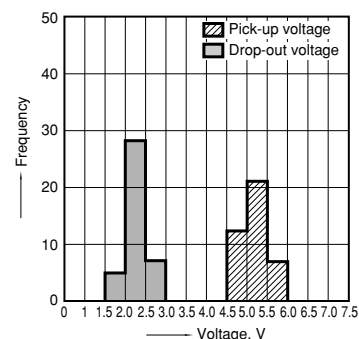

5. Distribution of operate and release time
Sample: ACT212, 40pcs.
* Without diode

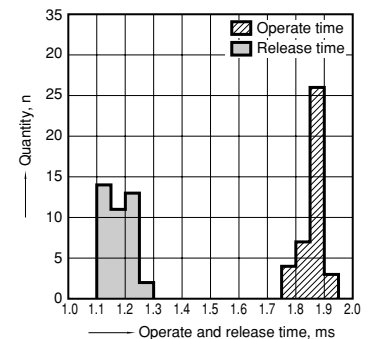

CT (ACT)

6-(1). Electrical life test (Motor free)

Sample: ACT212, 3pcs.
 Load: 5A steady, Inrush 25A, 14V DC
 Brake current: 13A 14V DC,
 Power window motor actual load (free condition)
 Operating frequency: (ON : OFF = 0.5s : 9.5s)
 Ambient temperature: Room temperature

Circuit:

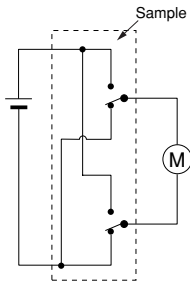

Change of pick-up and drop-out voltage

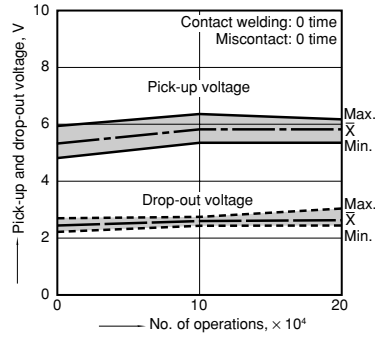

Change of contact resistance

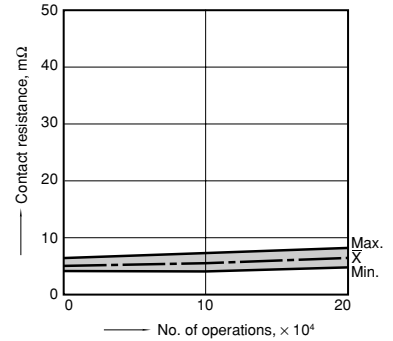

Load current waveform

Inrush current: 25A, Steady current: 6A
 Brake current: 13A

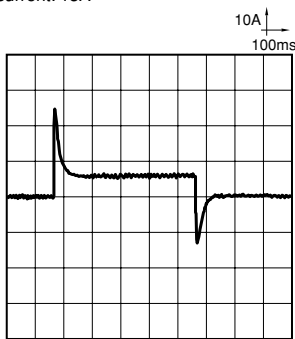

6-(2). Electrical life test (Motor lock)

Sample: ACT212, 3pcs.
 Load: 25A 14V DC
 Switching frequency: (ON : OFF = 0.5s : 9.5s)
 Ambient temperature: Room temperature

Circuit:

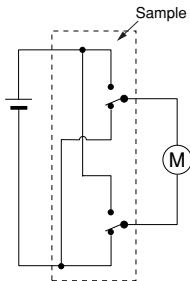

Change of pick-up and drop-out voltage

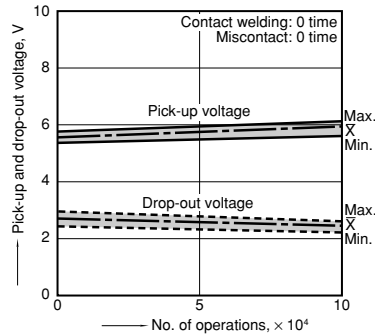

Change of contact resistance

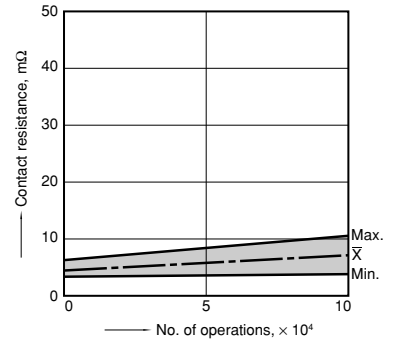

Load current waveform

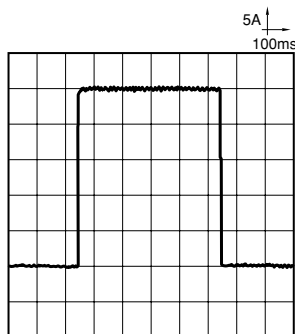

6-(3). Electrical life test (Motor lock)

Sample: ACT212, 3pcs.

Load: 20A 14V DC,

door lock motor actual load (Lock condition)

Switching frequency: (ON : OFF = 0.3s : 19.7s)

Ambient temperature: Room temperature

Circuit:

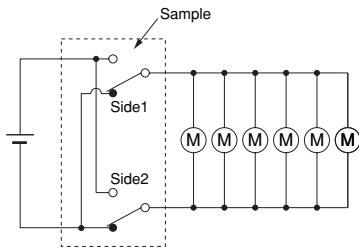

Change of pick-up and drop-out voltage

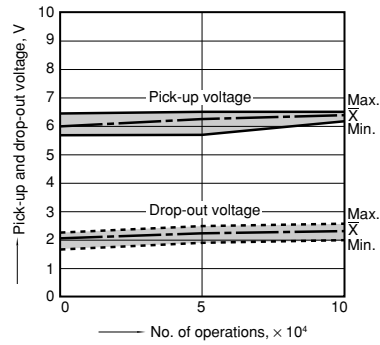

Change of contact resistance

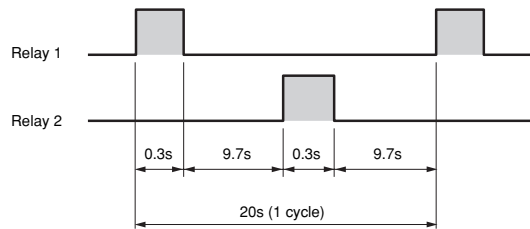
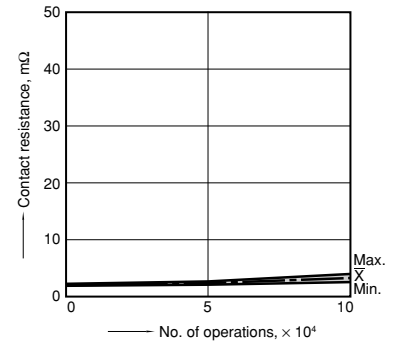

Load current waveform

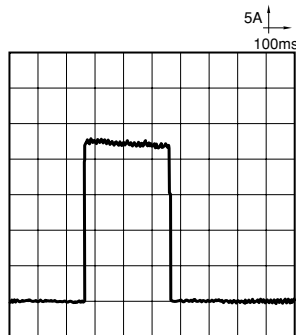

For Cautions for Use, see Relay Technical Information.