

## 114 dB, 192 kHz 6-Channel D/A Converter

### Features

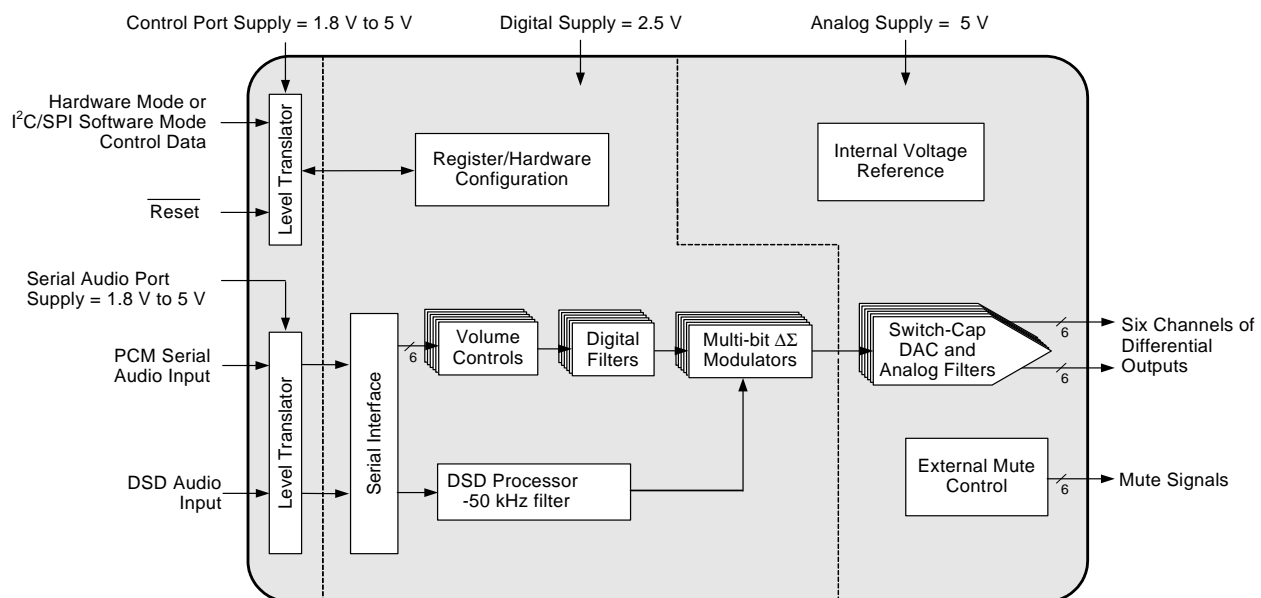
- ◆ Advanced Multi-bit Delta Sigma Architecture
- ◆ 24-bit Conversion
- ◆ Up to 192 kHz Sample Rates
- ◆ 114 dB Dynamic Range
- ◆ -100 dB THD+N
- ◆ Direct Stream Digital® (DSD™) Mode
- ◆ On-chip 50 kHz Filter
- ◆ Matched PCM and DSD Analog Output Levels
- ◆ Selectable Digital Filters
- ◆ Volume Control with 1 dB Step Size and Soft Ramp
- ◆ Low Clock-jitter Sensitivity
- ◆ +5 V Analog Supply, +2.5 V Digital Supply
- ◆ Separate 1.8 to 5 V Logic Supplies for the Control & Serial Ports

### Description

The CS4362A is a complete 6-channel digital-to-analog system. This D/A system includes digital de-emphasis, 1 dB step size volume control, ATAPI channel mixing, selectable fast and slow digital interpolation filters followed by an oversampled, multi-bit delta-sigma modulator which includes mismatch shaping technology that eliminates distortion due to capacitor mismatch. Following this stage is a multi-element switched capacitor stage and low-pass filter with differential analog outputs.

The CS4362A also has a proprietary DSD processor which allows for 50 kHz on-chip filtering without an intermediate decimation stage. The CS4362A is available in a 48-pin LQFP package in both Commercial (-40°C to +85°C) and Automotive grades (-40°C to +105°C). The CDB4362A Customer Demonstration board is also available for device evaluation and implementation suggestions. Please see "Ordering Information" on page 48 for complete details.

The CS4362A accepts PCM data at sample rates from 4 kHz to 216 kHz, DSD audio data, and delivers excellent sound quality. These features are ideal for multi-channel audio systems including SACD players, A/V receivers, digital TV's, mixing consoles, effects processors, sound cards, and automotive audio systems.



---

**TABLE OF CONTENTS**

<b>1. PIN DESCRIPTION .....</b>	<b>6</b>
<b>2. CHARACTERISTICS AND SPECIFICATIONS .....</b>	<b>8</b>
RECOMMENDED OPERATING CONDITIONS .....	8
ABSOLUTE MAXIMUM RATINGS .....	8
DAC ANALOG CHARACTERISTICS - COMMERCIAL (-CQZ) .....	9
DAC ANALOG CHARACTERISTICS - AUTOMOTIVE (-DQZ) .....	10
POWER AND THERMAL CHARACTERISTICS .....	11
COMBINED INTERPOLATION & ON-CHIP ANALOG FILTER RESPONSE .....	12
COMBINED INTERPOLATION & ON-CHIP ANALOG FILTER RESPONSE .....	13
DSD COMBINED DIGITAL & ON-CHIP ANALOG FILTER RESPONSE .....	13
DIGITAL CHARACTERISTICS .....	14
SWITCHING CHARACTERISTICS - PCM .....	15
SWITCHING CHARACTERISTICS - DSD .....	16
SWITCHING CHARACTERISTICS - CONTROL PORT - I <sup>2</sup> C FORMAT .....	17
SWITCHING CHARACTERISTICS - CONTROL PORT - SPI FORMAT .....	18
<b>3. TYPICAL CONNECTION DIAGRAM .....</b>	<b>19</b>
<b>4. APPLICATIONS .....</b>	<b>21</b>
4.1 Master Clock .....	21
4.2 Mode Select .....	21
4.3 Digital Interface Formats .....	23
4.4 Oversampling Modes .....	24
4.5 Interpolation Filter .....	24
4.6 De-emphasis .....	24
4.7 ATAPI Specification .....	25
4.8 Direct Stream Digital (DSD) Mode .....	26
4.9 Grounding and Power Supply Arrangements .....	26
4.9.1 Capacitor Placement .....	26
4.10 Analog Output and Filtering .....	26
4.11 Mute Control .....	27
4.12 Recommended Power-Up Sequence .....	28
4.12.1 Hardware Mode .....	28
4.12.2 Software Mode .....	28
4.13 Recommended Procedure for Switching Operational Modes .....	29
4.14 Control Port Interface .....	29
4.14.1 MAP Auto Increment .....	29
4.14.2 I <sup>2</sup> C Mode .....	29
4.14.2.1 I <sup>2</sup> C Write .....	29
4.14.2.2 I <sup>2</sup> C Read .....	30
4.14.3 SPI Mode .....	30
4.14.3.1 SPI Write .....	30
4.15 Memory Address Pointer (MAP) .....	31
4.16 INCR (Auto Map Increment Enable) .....	31
4.16.1 MAP4-0 (Memory Address Pointer) .....	31
<b>5. REGISTER QUICK REFERENCE .....</b>	<b>32</b>
<b>6. REGISTER DESCRIPTION .....</b>	<b>33</b>
6.1 Mode Control 1 (Address 01h) .....	33
6.1.1 Control Port Enable (CPEN) .....	33
6.1.2 Freeze Controls (FREEZE) .....	33
6.1.3 Master Clock Divide Enable (MCLKDIV) .....	33
6.1.4 DAC Pair Disable (DACx_DIS) .....	33
6.1.5 Power Down (PDN) .....	34
6.2 Mode Control 2 (Address 02h) .....	34

6.2.1 Digital Interface Format (DIF) .....	34
6.3 Mode Control 3 (Address 03h) .....	35
6.3.1 Soft Ramp and Zero Cross Control (SZC) .....	35
6.3.2 Single Volume Control (SNGLVOL) .....	36
6.3.3 Soft Volume Ramp-Up After Error (RMP_UP) .....	36
6.3.4 MuteC Polarity (MUTEC+/-) .....	36
6.3.5 Auto-Mute (AMUTE) .....	36
6.3.6 Mute Pin Control (MUTEC1, MUTEC0) .....	37
6.4 Filter Control (Address 04h) .....	37
6.4.1 Interpolation Filter Select (FILT_SEL) .....	37
6.4.2 De-Emphasis Control (DEM) .....	37
6.4.3 Soft Ramp-Down Before Filter Mode Change (RMP_DN) .....	37
6.5 Invert Control (Address 05h) .....	38
6.5.1 Invert Signal Polarity (Inv_Xx) .....	38
6.6 Mixing Control Pair 1 (Channels A1 & B1)(Address 06h)	
Mixing Control Pair 2 (Channels A2 & B2)(Address 09h)	
Mixing Control Pair 3 (Channels A3 & B3)(Address 0Ch) .....	38
6.6.1 Channel A Volume = Channel B Volume (A=B) .....	38
6.6.2 ATAPI Channel Mixing and Muting (ATAPI) .....	39
6.6.3 Functional Mode (FM) .....	40
6.7 Volume Control (Addresses 07h, 08h, 0Ah, 0Bh, 0Dh, 0Eh) .....	40
6.7.1 Mute (MUTE) .....	40
6.7.2 Volume Control (XX_VOL) .....	41
6.8 Chip Revision (Address 12h) .....	41
6.8.1 Part Number ID (PART) [Read Only] .....	41
6.8.2 Revision ID (REV) [Read Only] .....	41
<b>7. FILTER PLOTS .....</b>	<b>42</b>
<b>8. PARAMETER DEFINITIONS .....</b>	<b>46</b>
<b>9. PACKAGE DIMENSIONS .....</b>	<b>47</b>
<b>10. ORDERING INFORMATION .....</b>	<b>48</b>
<b>11. REFERENCES .....</b>	<b>48</b>
<b>12. REVISION HISTORY .....</b>	<b>49</b>

---

**LIST OF FIGURES**

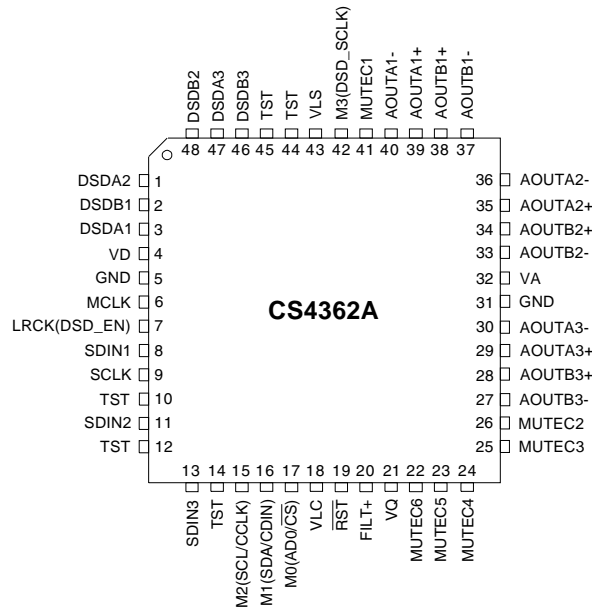
Figure 1. Serial Audio Interface Timing .....	15
Figure 2. Direct Stream Digital - Serial Audio Input Timing .....	16
Figure 3. Control Port Timing - I <sup>2</sup> C Format .....	17
Figure 4. Control Port Timing - SPI Format .....	18
Figure 5. Typical Connection Diagram, Software Mode .....	19
Figure 6. Typical Connection Diagram, Hardware Mode .....	20
Figure 7. Format 0 - Left-Justified up to 24-bit Data .....	23
Figure 8. Format 1 - I <sup>2</sup> S up to 24-bit Data .....	23
Figure 9. Format 2 - Right-Justified 16-bit Data .....	23
Figure 10. Format 3 - Right-Justified 24-bit Data .....	23
Figure 11. Format 4 - Right-Justified 20-bit Data .....	24
Figure 12. Format 5 - Right-Justified 18-bit Data .....	24
Figure 13. De-Emphasis Curve .....	25
Figure 14. ATAPI Block Diagram (x = channel pair 1, 2, or 3) .....	25
Figure 15. Full-Scale Output .....	27
Figure 16. Recommended Output Filter .....	27
Figure 17. Recommended Mute Circuitry .....	28
Figure 18. Control Port Timing, I <sup>2</sup> C Mode .....	30
Figure 19. Control Port Timing, SPI Mode .....	31
Figure 20. Single-Speed (fast) Stopband Rejection .....	42
Figure 21. Single-Speed (fast) Transition Band .....	42
Figure 22. Single-Speed (fast) Transition Band (detail) .....	42
Figure 23. Single-Speed (fast) Passband Ripple .....	42
Figure 24. Single-Speed (slow) Stopband Rejection .....	42
Figure 25. Single-Speed (slow) Transition Band .....	42
Figure 26. Single-Speed (slow) Transition Band (detail) .....	43
Figure 27. Single-Speed (slow) Passband Ripple .....	43
Figure 28. Double-Speed (fast) Stopband Rejection .....	43
Figure 29. Double-Speed (fast) Transition Band .....	43
Figure 30. Double-Speed (fast) Transition Band (detail) .....	43
Figure 31. Double-Speed (fast) Passband Ripple .....	43
Figure 32. Double-Speed (slow) Stopband Rejection .....	44
Figure 33. Double-Speed (slow) Transition Band .....	44
Figure 34. Double-Speed (slow) Transition Band (detail) .....	44
Figure 35. Double-Speed (slow) Passband Ripple .....	44
Figure 36. Quad-Speed (fast) Stopband Rejection .....	44
Figure 37. Quad-Speed (fast) Transition Band .....	44
Figure 38. Quad-Speed (fast) Transition Band (detail) .....	45
Figure 39. Quad-Speed (fast) Passband Ripple .....	45
Figure 40. Quad-Speed (slow) Stopband Rejection .....	45
Figure 41. Quad-Speed (slow) Transition Band .....	45
Figure 42. Quad-Speed (slow) Transition Band (detail) .....	45
Figure 43. Quad-Speed (slow) Passband Ripple .....	45

---

**LIST OF TABLES**

Table 1. Common Clock Frequencies .....	21
Table 2. Digital Interface Format, Stand-Alone Mode Options .....	22
Table 3. Mode Selection, Stand-Alone Mode Options .....	22
Table 4. Direct Stream Digital (DSD), Stand-Alone Mode Options .....	22
Table 5. Digital Interface Formats - PCM Mode .....	34
Table 6. Digital Interface Formats - DSD Mode .....	35
Table 7. ATAPI Decode .....	39
Table 8. Example Digital Volume Settings .....	41

# 1. PIN DESCRIPTION



Pin Name	#	Pin Description
VD	4	<b>Digital Power (Input)</b> - Positive power supply for the digital section. Refer to the Recommended Operating Conditions for appropriate voltages.
GND	5,31	<b>Ground (Input)</b> - Ground reference. Should be connected to analog ground.
MCLK	6	<b>Master Clock (Input)</b> - Clock source for the delta-sigma modulator and digital filters. <a href="#">Table 1</a> illustrates several standard audio sample rates and the required master clock frequencies.
LRCK	7	<b>Left Right Clock (Input)</b> - Determines which channel, Left or Right, is currently active on the serial audio data line. The frequency of the left/right clock must be at the audio sample rate, Fs.
SDIN1	8	<b>Serial Data Input (Input)</b> - Input for two's complement serial audio data.
SDIN2	11	
SDIN3	13	
SCLK	9	<b>Serial Clock (Input)</b> - Serial clocks for the serial audio interface.
TST	10,12 14,44 45	<b>Test</b> - These pins need to be tied to analog ground.
$\overline{\text{RST}}$	19	<b>Reset (Input)</b> - The device enters a low power mode and all internal registers are reset to their default settings when low.
VA	32	<b>Analog Power (Input)</b> - Positive power supply for the analog section. Refer to the Recommended Operating Conditions for appropriate voltages.
VLS	43	<b>Serial Audio Interface Power (Input)</b> - Determines the required signal level for the serial audio interface. Refer to the Recommended Operating Conditions for appropriate voltages.
VLC	18	<b>Control Port Power (Input)</b> - Determines the required signal level for the control port and hardware mode configuration pins. Refer to the Recommended Operating Conditions for appropriate voltages.

Pin Name	#	Pin Description
VQ	21	<b>Quiescent Voltage (Output)</b> - Filter connection for internal quiescent voltage. VQ must be capacitively coupled to analog ground, as shown in the Typical Connection Diagram. The nominal voltage level is specified in the Analog Characteristics and Specifications section. VQ presents an appreciable source impedance and any current drawn from this pin will alter device performance. However, VQ can be used to bias the analog circuitry assuming there is no AC signal component and the DC current is less than the maximum specified in the Analog Characteristics and Specifications section.
FILT+	20	<b>Positive Voltage Reference (Output)</b> - Positive reference voltage for the internal sampling circuits. Requires the capacitive decoupling to analog ground as shown in the Typical Connection Diagram.
AOUTA1 +,-	39,40	<b>Differential Analog Output (Output)</b> - The full-scale differential analog output level is specified in the Analog Characteristics specification table.
AOUTB1 +,-	38,37	
AOUTA2 +,-	35,36	
AOUTB2 +,-	34,33	
AOUTA3 +,-	29,30	
AOUTB3 +,-	28,27	
MUTEC1	41	<b>Mute Control (Output)</b> - These pins are intended to be used as a control for external mute circuits on the line outputs to prevent the clicks and pops that can occur in any single supply system. Use of Mute Control is not mandatory but recommended for designs requiring the absolute minimum in extraneous clicks and pops.
MUTEC2	26	
MUTEC3	25	
MUTEC4	24	
MUTEC5	23	
MUTEC6	22	
<b>Hardware Mode Definitions</b>		
M0	17	<b>Mode Selection (Input)</b> - Determines the operational mode of the device as detailed in <a href="#">Table 6</a> and <a href="#">Table 7</a> .
M2	16	
M3	15	
	42	
<b>Software Mode Definitions</b>		
SCL/CCLK	15	<b>Serial Control Port Clock (Input)</b> - Serial clock for the serial control port. Requires an external pull-up resistor to the logic interface voltage in I <sup>2</sup> C <sup>®</sup> Mode as shown in the Typical Connection Diagram.
SDA/CDIN	16	<b>Serial Control Port Data (Input/Output)</b> - SDA is a data I/O line in I <sup>2</sup> C Mode and is open drain, requiring an external pull-up resistor to the logic interface voltage, as shown in the Typical Connection Diagram; CDIN is the input data line for the control port interface in SPI <sup>™</sup> mode.
AD0/ $\overline{\text{CS}}$	17	<b>Address Bit 0 (C) / Control Port Chip Select (SPI) (Input)</b> - AD0 is a chip address pin in I <sup>2</sup> C Mode; CS is the chip select signal for SPI mode.
<b>DSD Definitions</b>		
DSDA1	3	<b>Direct Stream Digital Input (Input)</b> - Input for Direct Stream Digital serial audio data.
DSDB1	2	
DSDA2	1	
DSDB2	48	
DSDA3	47	
DSDB3	46	
DSD_SCLK	42	<b>DSD Serial Clock (Input)</b> - Serial clock for the Direct Stream Digital serial audio interface.
DSD_EN	7	<b>DSD Enable (Input)</b> - When held at logic '1', the device will enter DSD Mode (Stand-Alone Mode only).

## 2. CHARACTERISTICS AND SPECIFICATIONS

### RECOMMENDED OPERATING CONDITIONS

(GND = 0 V; all voltages with respect to ground.)

Parameters	Symbol	Min	Typ	Max	Units	
DC Power Supply	Analog Power	VA	4.75	5.0	5.25	V
	Digital Internal Power	VD	2.37	2.5	2.63	V
	Serial Data Port Interface Power	VLS	1.71	5.0	5.25	V
	Control Port Interface Power	VLC	1.71	5.0	5.25	V
Ambient Operating Temperature (power applied)	T <sub>A</sub>	Commercial Grade (-CQZ)	-40	-	+85	°C
		Automotive Grade (-DQZ)	-40	-	+105	°C

### ABSOLUTE MAXIMUM RATINGS

(GND = 0 V; all voltages with respect to ground.)

Parameters	Symbol	Min	Max	Units	
DC Power Supply	Analog Power	VA	-0.3	6.0	V
	Digital Internal Power	VD	-0.3	3.2	V
	Serial Data Port Interface Power	VLS	-0.3	6.0	V
	Control Port Interface Power	VLC	-0.3	6.0	V
Input Current	Any Pin Except Supplies	I <sub>in</sub>	-	±10	mA
Digital Input Voltage	Serial Data Port Interface	V <sub>IND-S</sub>	-0.3	VLS+ 0.4	V
	Control Port Interface	V <sub>IND-C</sub>	-0.3	VLC+ 0.4	V
Ambient Operating Temperature (power applied)	T <sub>op</sub>	-55	125	°C	
Storage Temperature	T <sub>stg</sub>	-65	150	°C	

**WARNING:** Operation at or beyond these limits may result in permanent damage to the device. Normal operation is not guaranteed at these extremes.



## DAC ANALOG CHARACTERISTICS - COMMERCIAL (-CQZ)

Test Conditions (unless otherwise specified):  $V_A = V_{LS} = V_{LC} = 5\text{ V}$ ;  $V_D = 2.5\text{ V}$ ;  $T_A = 25^\circ\text{C}$ ; Full-Scale 997 Hz input sine wave (Note 1); Tested under max ac-load resistance; Valid with FILT+ and VQ capacitors as shown in "Typical Connection Diagram" on page 19; Measurement Bandwidth 10 Hz to 20 kHz.

Parameters	Symbol	Min	Typ	Max	Unit				
<b>FS = 48 kHz, 96 kHz, 192 kHz and DSD</b>									
Dynamic Range	24-bit A-weighted	108	114	-	dB				
	Unweighted	105	111	-	dB				
	16-bit A-weighted	-	97	-	dB				
	(Note 2) Unweighted	-	94	-	dB				
Total Harmonic Distortion + Noise	24-bit	THD+N			dB				
	0 dB					-	-100	-94	
	-20 dB					-	-91	-	
	-60 dB					-	-51	-45	
	(Note 2) 16-bit					0 dB	-	-94	-
	-20 dB					-	-74	-	
-60 dB	-	-34	-						
Idle Channel Noise / Signal-to-noise Ratio		-	114	-	dB				
Interchannel Isolation	(1 kHz)	-	110	-	dB				
<b>DC Accuracy</b>									
Interchannel Gain Mismatch		-	0.1	-	dB				
Gain Drift		-	100	-	ppm/°C				
<b>Analog Output</b>									
Full-scale Differential Output Voltage	$V_{FS}$	$128\% \cdot V_A$	$132\% \cdot V_A$	$136\% \cdot V_A$	Vpp				
Output Impedance	(Note 3) $Z_{OUT}$	-	130	-	$\Omega$				
Max DC Current Draw From an AOUT Pin	$I_{OUTmax}$	-	1.0	-	mA				
Min AC-load Resistance	$R_L$	-	3	-	k $\Omega$				
Max Load Capacitance	$C_L$	-	100	-	pF				
Quiescent Voltage	$V_Q$	-	$50\% \cdot V_A$	-	VDC				
Max Current draw from $V_Q$	$I_{QMAX}$	-	10	-	$\mu\text{A}$				

### Notes:

1. One-half LSB of triangular PDF dither is added to data.
2. Performance limited by 16-bit quantization noise.
3.  $V_{FS}$  is tested under load  $R_L$  and includes attenuation due to  $Z_{OUT}$

## DAC ANALOG CHARACTERISTICS - AUTOMOTIVE (-DQZ)

Test Conditions (unless otherwise specified):  $V_A = 4.75$  to  $5.25$  V;  $V_{LS} = 1.71$  to  $5.25$  V;  $V_{LC} = 1.71$  to  $5.25$  V;  $V_D = 2.37$  to  $2.63$  V;  $T_A = -40^\circ\text{C}$  to  $85^\circ\text{C}$ ; Full-Scale 997 Hz input sine wave (Note 1); Tested under max ac-load resistance; Valid with FILT+ and VQ capacitors as shown in "Typical Connection Diagram" on page 19; Measurement Bandwidth 10 Hz to 20 kHz.

Parameters	Symbol	Min	Typ	Max	Unit				
<b>FS = 48 kHz, 96 kHz, 192 kHz and DSD</b>									
Dynamic Range	24-bit A-weighted	105	114	-	dB				
	Unweighted	102	111	-	dB				
	16-bit A-weighted	-	97	-	dB				
	(Note 2) Unweighted	-	94	-	dB				
Total Harmonic Distortion + Noise	24-bit	THD+N			dB				
	0 dB					-	-100	-91	
	-20 dB					-	-91	-	
	-60 dB					-	-51	-42	
	(Note 2) 16-bit					0 dB	-	-94	-
	-20 dB					-	-74	-	
-60 dB	-	-34	-						
Idle Channel Noise / Signal-to-noise Ratio		-	114	-	dB				
Interchannel Isolation	(1 kHz)	-	110	-	dB				
<b>DC Accuracy</b>									
Interchannel Gain Mismatch		-	0.1	-	dB				
Gain Drift		-	100	-	ppm/ $^\circ\text{C}$				
<b>Analog Output</b>									
Full-scale Differential Output Voltage	$V_{FS}$	$128\% \cdot V_A$	$132\% \cdot V_A$	$136\% \cdot V_A$	V <sub>pp</sub>				
Output Impedance	(Note 3) $Z_{OUT}$	-	130	-	$\Omega$				
Max DC Current Draw From an AOUT Pin	$I_{OUTmax}$	-	1.0	-	mA				
Min AC-load Resistance	$R_L$	-	3	-	k $\Omega$				
Max Load Capacitance	$C_L$	-	100	-	pF				
Quiescent Voltage	$V_Q$	-	$50\% \cdot V_A$	-	VDC				
Max Current draw from $V_Q$	$I_{QMAX}$	-	10	-	$\mu\text{A}$				

**POWER AND THERMAL CHARACTERISTICS**

Parameters	Symbol	Min	Typ	Max	Units	
<b>Power Supplies</b>						
Power Supply Current (Note 4)	Normal Operation, VA= 5 V	$I_A$	-	60	65	mA
	VD= 2.5 V	$I_D$	-	16	22	mA
	(Note 5) Interface Current, VLC=5 V	$I_{LC}$	-	2	-	$\mu$ A
	VLS=5 V	$I_{LS}$	-	84	-	$\mu$ A
(Note 6) Power-down State (all supplies)	$I_{pd}$	-	200	-	$\mu$ A	
Power Dissipation (Note 4)	VA = 5 V, VD = 2.5 V		-	340	390	mW
	Normal Operation (Note 6) Power-down		-	1	-	mW
Package Thermal Resistance	Multi-layer	$\theta_{JA}$	-	48	-	$^{\circ}$ C/Watt
	Two-layer	$\theta_{JA}$	-	65	-	$^{\circ}$ C/Watt
		$\theta_{JC}$	-	15	-	$^{\circ}$ C/Watt
Power Supply Rejection Ratio (Note 7)	(1 kHz)	PSRR	-	60	-	dB
	(60 Hz)		-	40	-	dB

**Notes:**

- Current consumption increases with increasing FS within a given speed mode and is signal-dependent. Max values are based on highest FS and highest MCLK.
- $I_{LC}$  measured with no external loading on the SDA pin.
- Power-down Mode is defined as  $\overline{RST}$  pin = Low with all clock and data lines held static.
- Valid with the recommended capacitor values on FILT+ and VQ as shown in [Figure 5](#) and [Figure 6](#).

## COMBINED INTERPOLATION & ON-CHIP ANALOG FILTER RESPONSE

The filter characteristics have been normalized to the sample rate ( $F_s$ ) and can be referenced to the desired sample rate by multiplying the given characteristic by  $F_s$ .

See [Note 12](#).

Parameter	Fast Roll-Off			Unit	
	Min	Typ	Max		
<b>Combined Digital and On-chip Analog Filter Response - Single-Speed Mode - 48 kHz</b>					
Passband ( <a href="#">Note 9</a> )	to -0.01 dB corner	0	-	.454	$F_s$
	to -3 dB corner	0	-	.499	$F_s$
Frequency Response	10 Hz to 20 kHz	-0.01	-	+0.01	dB
Stop Band		0.547	-	-	$F_s$
Stop-band Attenuation	( <a href="#">Note 10</a> )	102	-	-	dB
Group Delay		-	10.4/ $F_s$	-	s
De-emphasis Error ( <a href="#">Note 11</a> ) (Relative to 1 kHz)	$F_s = 32$ kHz	-	-	$\pm 0.23$	dB
	$F_s = 44.1$ kHz	-	-	$\pm 0.14$	dB
	$F_s = 48$ kHz	-	-	$\pm 0.09$	dB
<b>Combined Digital and On-chip Analog Filter Response - Double-Speed Mode - 96 kHz</b>					
Passband ( <a href="#">Note 9</a> )	to -0.01 dB corner	0	-	.430	$F_s$
	to -3 dB corner	0	-	.499	$F_s$
Frequency Response	10 Hz to 20 kHz	-0.01	-	+0.01	dB
Stop Band		.583	-	-	$F_s$
Stop-band Attenuation	( <a href="#">Note 10</a> )	80	-	-	dB
Group Delay		-	6.15/ $F_s$	-	s
<b>Combined Digital and On-chip Analog Filter Response - Quad-Speed Mode - 192 kHz</b>					
Passband ( <a href="#">Note 9</a> )	to -0.01 dB corner	0	-	.105	$F_s$
	to -3 dB corner	0	-	.490	$F_s$
Frequency Response	10 Hz to 20 kHz	-0.01	-	+0.01	dB
Stop Band		.635	-	-	$F_s$
Stop-band Attenuation	( <a href="#">Note 10</a> )	90	-	-	dB
Group Delay		-	7.1/ $F_s$	-	s

### Notes:

8. Slow roll-off interpolation filter is only available in Software Mode.
9. Response is clock-dependent and will scale with  $F_s$ .
10. For Single-Speed Mode, the Measurement Bandwidth is from stopband to 3  $F_s$ .  
For Double-Speed Mode, the Measurement Bandwidth is from stopband to 3  $F_s$ .  
For Quad-Speed Mode, the Measurement Bandwidth is from stopband to 1.34  $F_s$ .
11. De-emphasis is available only in Single-Speed Mode; only 44.1 kHz De-emphasis is available in Hardware Mode.
12. Amplitude vs. Frequency plots of this data are available in [Section 7. "Filter Plots" on page 42](#).

**COMBINED INTERPOLATION & ON-CHIP ANALOG FILTER RESPONSE**

(CONTINUED)

Parameter	Slow Roll-Off (Note 8)			Unit	
	Min	Typ	Max		
<b>Single-Speed Mode - 48 kHz</b>					
Passband (Note 9)	to -0.01 dB corner	0	-	0.417	Fs
	to -3 dB corner	0	-	0.499	Fs
Frequency Response	10 Hz to 20 kHz	-0.01	-	+0.01	dB
Stop Band		.583	-	-	Fs
Stop-band Attenuation	(Note 10)	64	-	-	dB
Group Delay		-	7.8/Fs	-	s
De-emphasis Error (Note 11) (Relative to 1 kHz)	Fs = 32 kHz	-	-	±0.36	dB
	Fs = 44.1 kHz	-	-	±0.21	dB
	Fs = 48 kHz	-	-	±0.14	dB
<b>Double-Speed Mode - 96 kHz</b>					
Passband (Note 9)	to -0.01 dB corner	0	-	.296	Fs
	to -3 dB corner	0	-	.499	Fs
Frequency Response	10 Hz to 20 kHz	-0.01	-	+0.01	dB
Stop Band		.792	-	-	Fs
Stop-band Attenuation	(Note 10)	70	-	-	dB
Group Delay		-	5.4/Fs	-	s
<b>Quad-Speed Mode - 192 kHz</b>					
Passband (Note 9)	to -0.01 dB corner	0	-	.104	Fs
	to -3 dB corner	0	-	.481	Fs
Frequency Response	10 Hz to 20 kHz	-0.01	-	+0.01	dB
Stop Band		.868	-	-	Fs
Stop-band Attenuation	(Note 10)	75	-	-	dB
Group Delay		-	6.6/Fs	-	s

**DSD COMBINED DIGITAL & ON-CHIP ANALOG FILTER RESPONSE**

Parameter	Min	Typ	Max	Unit	
<b>DSD Processor mode</b>					
Passband (Note 9)	to -3 dB corner	0	-	50	kHz
Frequency Response	10 Hz to 20 kHz	-0.05	-	+0.05	dB
Roll-off		27	-	-	dB/Oct

**DIGITAL CHARACTERISTICS**

Parameters	Symbol	Min	Typ	Max	Units
Input Leakage Current (Note 13)	$I_{in}$	-	-	±10	μA
Input Capacitance		-	8	-	pF
High-level Input Voltage	Serial I/O	$V_{IH}$	70%	-	$V_{LS}$
	Control I/O	$V_{IH}$	70%	-	$V_{LC}$
Low-level Input Voltage	Serial I/O	$V_{IL}$	-	-	$V_{LS}$
	Control I/O	$V_{IL}$	-	-	$V_{LC}$
Low-level Output Voltage ( $I_{OL} = -1.2$ mA)	Control I/O = 3.3 V, 5 V	$V_{OL}$	-	-	20% $V_{LC}$
	Control I/O = 1.8 V, 2.5 V	$V_{OL}$	-	-	25% $V_{LC}$
Maximum MUTE C Drive Current	$I_{max}$	-	3	-	mA
MUTE C High-level Output Voltage	$V_{OH}$	-	VA	-	V
MUTE C Low-level Output Voltage	$V_{OL}$	-	0	-	V

13. Any pin except supplies. Transient currents of up to ±100 mA on the input pins will not cause SCR latch-up.

## SWITCHING CHARACTERISTICS - PCM

(Inputs: Logic 0 = GND, Logic 1 = VLS,  $C_L = 30$  pF)

Parameters	Symbol	Min	Max	Units	
$\overline{\text{RST}}$ pin Low Pulse Width (Note 14)		1	-	ms	
MCLK Frequency		1.024	55.2	MHz	
MCLK Duty Cycle (Note 15)		45	55	%	
Input Sample Rate - LRCK	Single-speed Mode	$F_s$	4	54	kHz
	Double-speed Mode	$F_s$	50	108	kHz
	Quad-speed Mode	$F_s$	100	216	kHz
LRCK Duty Cycle		45	55	%	
SCLK Duty Cycle		45	55	%	
SCLK High Time	$t_{\text{sckh}}$	8	-	ns	
SCLK Low Time	$t_{\text{sckl}}$	8	-	ns	
LRCK Edge to SCLK rising edge	$t_{\text{lcks}}$	5	-	ns	
SDIN Setup Time before SCLK rising edge	$t_{\text{ds}}$	3	-	ns	
SDIN Hold Time after SCLK rising edge	$t_{\text{dh}}$	5	-	ns	

### Notes:

14. After powering up,  $\overline{\text{RST}}$  should be held low until after the power supplies and clocks are settled.
15. See [Table 1 on page 21](#) for suggested MCLK frequencies.

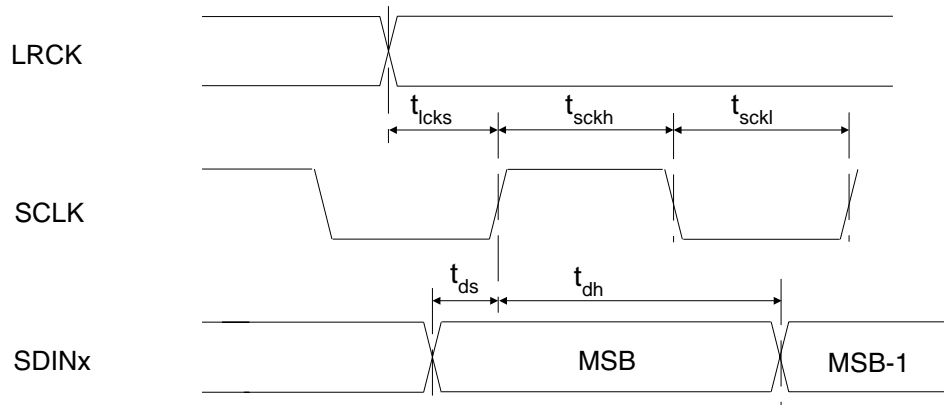
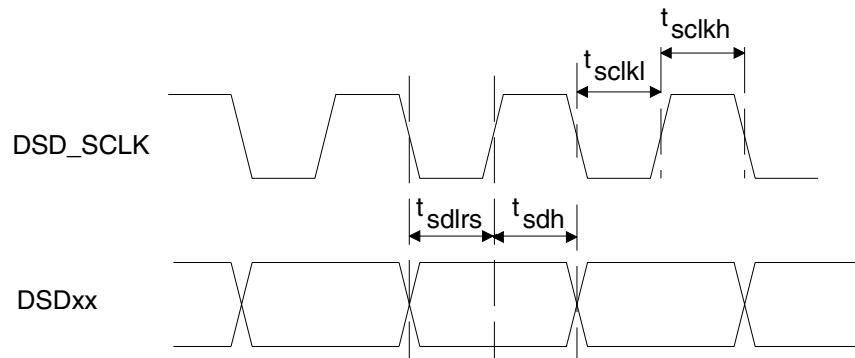


Figure 1. Serial Audio Interface Timing

## SWITCHING CHARACTERISTICS - DSD

(Logic 0 = AGND = DGND; Logic 1 = VLS;  $C_L = 20$  pF)

Parameter	Symbol	Min	Typ	Max	Unit
MCLK Duty Cycle		40	-	60	%
DSD_SCLK Pulse Width Low	$t_{sckl}$	160	-	-	ns
DSD_SCLK Pulse Width High	$t_{sckh}$	160	-	-	ns
DSD_SCLK Frequency	(64x Oversampled) (128x Oversampled)	1.024 2.048	-	3.2 6.4	MHz MHz
DSD_A / _B valid to DSD_SCLK rising setup time	$t_{sdhrs}$	20	-	-	ns
DSD_SCLK rising to DSD_A or DSD_B hold time	$t_{sdh}$	20	-	-	ns



**Figure 2. Direct Stream Digital - Serial Audio Input Timing**



## SWITCHING CHARACTERISTICS - CONTROL PORT - I<sup>2</sup>C FORMAT

(Inputs: Logic 0 = GND, Logic 1 = VLC, C<sub>L</sub> = 30 pF)

Parameter	Symbol	Min	Max	Unit
SCL Clock Frequency	f <sub>scl</sub>	-	100	kHz
RST Rising Edge to Start	t <sub>irs</sub>	500	-	ns
Bus Free Time Between Transmissions	t <sub>buf</sub>	4.7	-	μs
Start Condition Hold Time (prior to first clock pulse)	t <sub>hdst</sub>	4.0	-	μs
Clock Low time	t <sub>low</sub>	4.7	-	μs
Clock High Time	t <sub>high</sub>	4.0	-	μs
Setup Time for Repeated Start Condition	t <sub>sust</sub>	4.7	-	μs
SDA Hold Time from SCL Falling (Note 16)	t <sub>hdd</sub>	0	-	μs
SDA Setup time to SCL Rising	t <sub>sud</sub>	250	-	ns
Rise Time of SCL and SDA	t <sub>rc</sub> , t <sub>rc</sub>	-	1	μs
Fall Time SCL and SDA	t <sub>fc</sub> , t <sub>fc</sub>	-	300	ns
Setup Time for Stop Condition	t <sub>susp</sub>	4.7	-	μs
Acknowledge Delay from SCL Falling	t <sub>ack</sub>	300	1000	ns

### Notes:

16. Data must be held for sufficient time to bridge the transition time, t<sub>fc</sub>, of SCL.

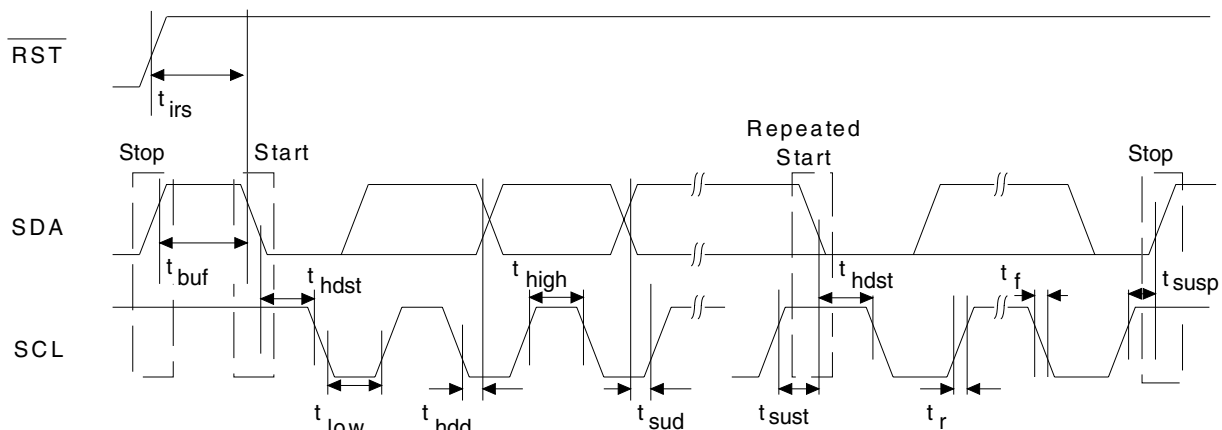


Figure 3. Control Port Timing - I<sup>2</sup>C Format

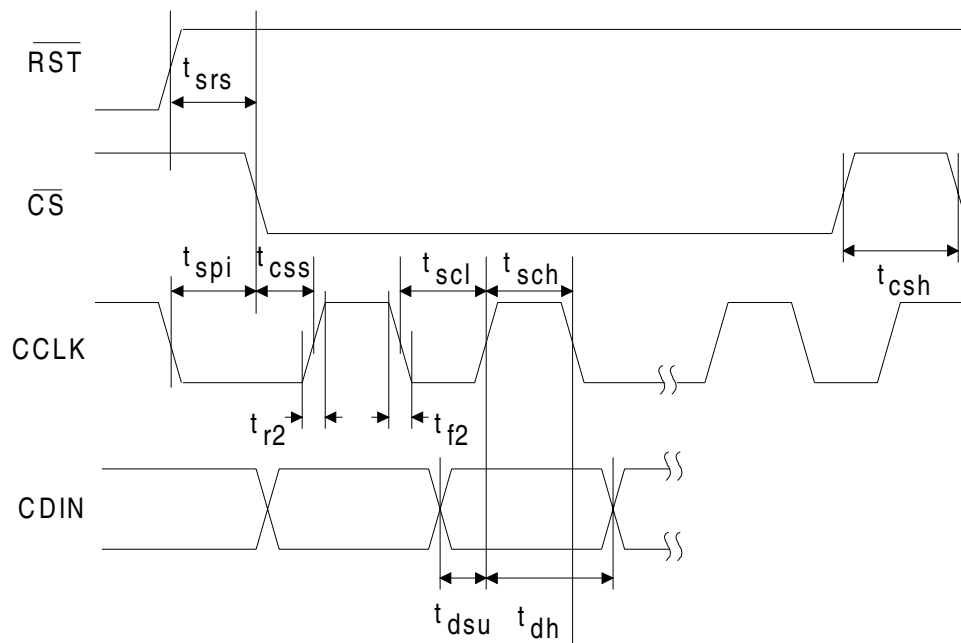
## SWITCHING CHARACTERISTICS - CONTROL PORT - SPI FORMAT

(Inputs: Logic 0 = GND, Logic 1 = VLC,  $C_L = 30$  pF)

Parameter	Symbol	Min	Max	Unit
CCLK Clock Frequency	$f_{sclk}$	-	6	MHz
RST Rising Edge to CS Falling	$t_{srs}$	500	-	ns
CCLK Edge to $\overline{CS}$ Falling (Note 17)	$t_{spi}$	500	-	ns
$\overline{CS}$ High Time Between Transmissions	$t_{csh}$	1.0	-	$\mu$ s
$\overline{CS}$ Falling to CCLK Edge	$t_{css}$	20	-	ns
CCLK Low Time	$t_{scl}$	66	-	ns
CCLK High Time	$t_{sch}$	66	-	ns
CDIN to CCLK Rising Setup Time	$t_{dsu}$	40	-	ns
CCLK Rising to DATA Hold Time (Note 18)	$t_{dh}$	15	-	ns
Rise Time of CCLK and CDIN (Note 19)	$t_{r2}$	-	100	ns
Fall Time of CCLK and CDIN (Note 19)	$t_{f2}$	-	100	ns

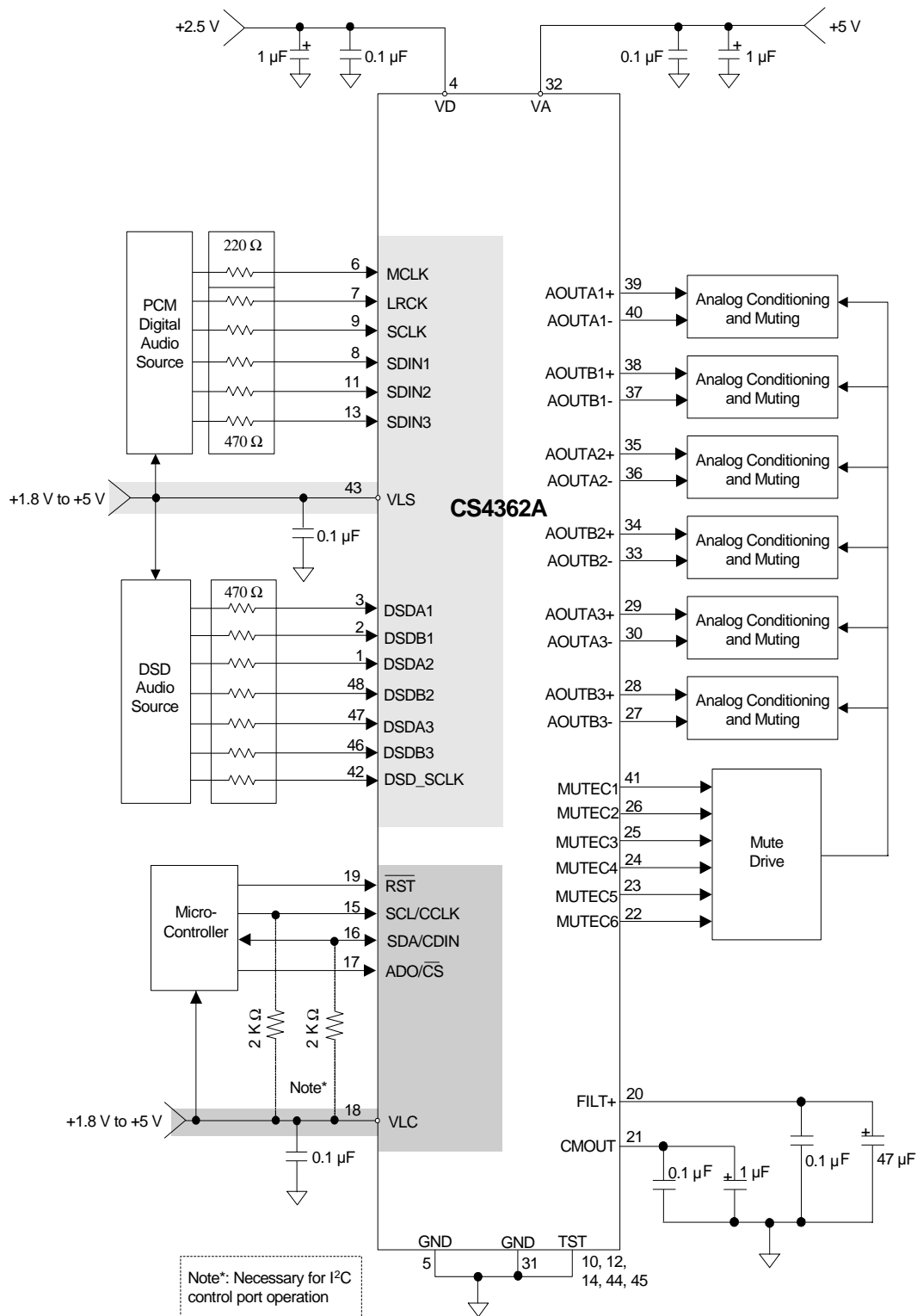
### Notes:

17.  $t_{spi}$  only needed before first falling edge of  $\overline{CS}$  after  $\overline{RST}$  rising edge.  $t_{spi} = 0$  at all other times.
18. Data must be held for sufficient time to bridge the transition time of CCLK.
19. For  $F_{SCK} < 1$  MHz.

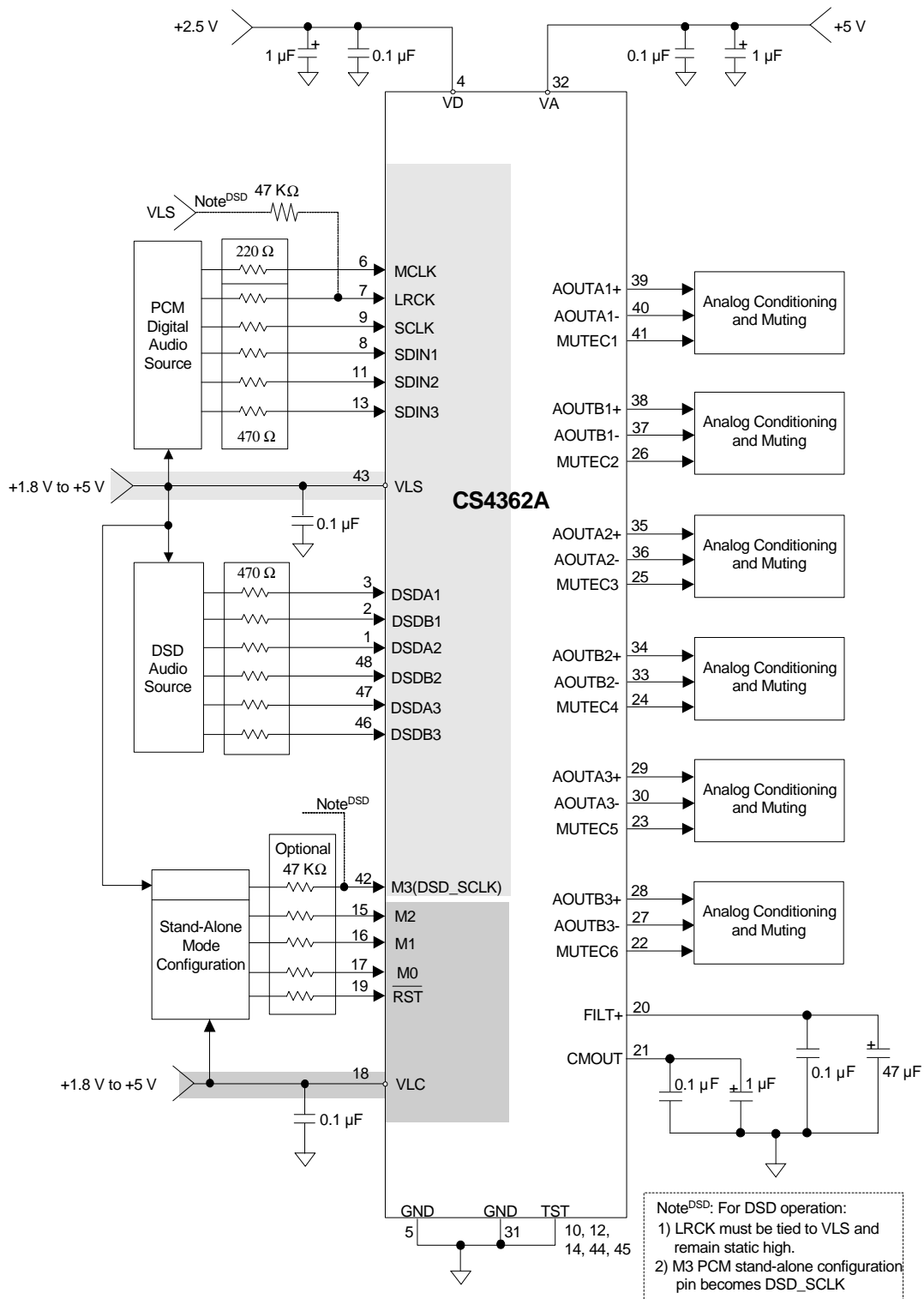


**Figure 4. Control Port Timing - SPI Format**

### 3. TYPICAL CONNECTION DIAGRAM



**Figure 5. Typical Connection Diagram, Software Mode**


**Figure 6. Typical Connection Diagram, Hardware Mode**

## 4. APPLICATIONS

The CS4362A serially accepts two's-complement formatted PCM data at standard audio sample rates including 48, 44.1, and 32 kHz in SSM, 96, 88.2, and 64 kHz in DSM, and 192, 176.4, and 128 kHz in QSM. Audio data is input via the serial data input pins (SDINx). The Left/Right Clock (LRCK) determines which channel is currently being input on SDINx, and the Serial Clock (SCLK) clocks audio data into the input data buffer.

The CS4362A can be configured in Hardware Mode by the M0, M1, M2, M3, and DSD\_EN pins and in Software Mode through I<sup>2</sup>C or SPI.

### 4.1 Master Clock

MCLK/LRCK must be an integer ratio as shown in [Table 1](#). The LRCK frequency is equal to  $F_s$ , the frequency at which words for each channel are input to the device. The MCLK-to-LRCK frequency ratio is detected automatically during the initialization sequence by counting the number of MCLK transitions during a single LRCK period. Internal dividers are then set to generate the proper internal clocks. [Table 1](#) illustrates several standard audio sample rates and the required MCLK and LRCK frequencies. Please note there is no required phase relationship, but MCLK, LRCK, and SCLK must be synchronous.

Speed Mode (sample-rate range)	Sample Rate (kHz)	MCLK (MHz)				Software Mode Only
<b>MCLK Ratio</b>		<b>256x</b>	<b>384x</b>	<b>512x</b>	<b>768x</b>	<b>1024x*</b>
<b>Single-Speed (4 to 50 kHz)</b>	32	8.1920	12.2880	16.3840	24.5760	32.7680
	44.1	11.2896	16.9344	22.5792	33.8688	45.1584
	48	12.2880	18.4320	24.5760	36.8640	49.1520
<b>MCLK Ratio</b>		<b>128x</b>	<b>192x</b>	<b>256x</b>	<b>384x</b>	<b>512x*</b>
<b>Double-Speed (50 to 100 kHz)</b>	64	8.1920	12.2880	16.3840	24.5760	32.7680
	88.2	11.2896	16.9344	22.5792	33.8688	45.1584
	96	12.2880	18.4320	24.5760	36.8640	49.1520
<b>MCLK Ratio</b>		<b>64x</b>	<b>96x</b>	<b>128x</b>	<b>192x</b>	<b>256x*</b>
<b>Quad-Speed (100 to 200 kHz)</b>	176.4	11.2896	16.9344	22.5792	33.8688	45.1584
	192	12.2880	18.4320	24.5760	36.8640	49.1520

**Note:** These modes are only available in Software Mode by setting the MCLKDIV bit = 1.

**Table 1. Common Clock Frequencies**

### 4.2 Mode Select

In Hardware Mode, operation is determined by the Mode Select pins. The states of these pins are continually scanned for any changes; however, the mode should only be changed while the device is in reset ( $\overline{\text{RST}}$  pin low) to ensure proper switching from one mode to another. These pins require connection to supply or ground as outlined in [Figure 6](#). VLC supplies M0, M1, and M2. VLS supplies M3 and DSD\_EN. [Tables 2 - 4](#) show the decode of these pins.

In Software Mode, the operational mode and data format are set in the FM and DIF registers. See [“Digital Interface Format \(DIF\)” on page 34](#) and [“Functional Mode \(FM\)” on page 40](#).

M1 (DIF1)	M0 (DIF0)	DESCRIPTION	FORMAT	FIGURE
0	0	Left-justified, up to 24-bit data	0	<a href="#">Figure 7</a>
0	1	I <sup>2</sup> S, up to 24-bit data	1	<a href="#">Figure 8</a>
1	0	Right-justified, 16-bit Data	2	<a href="#">Figure 9</a>
1	1	Right-justified, 24-bit Data	3	<a href="#">Figure 10</a>

**Table 2. Digital Interface Format, Stand-Alone Mode Options**

M3	M2 (DEM)	DESCRIPTION
0	0	Single-speed without De-emphasis (4 to 50 kHz sample rates)
0	1	Single-speed with 44.1 kHz De-Emphasis; see <a href="#">Figure 13</a>
1	0	Double-speed (50 to 100 kHz sample rates)
1	1	Quad-speed (100 to 200 kHz sample rates)

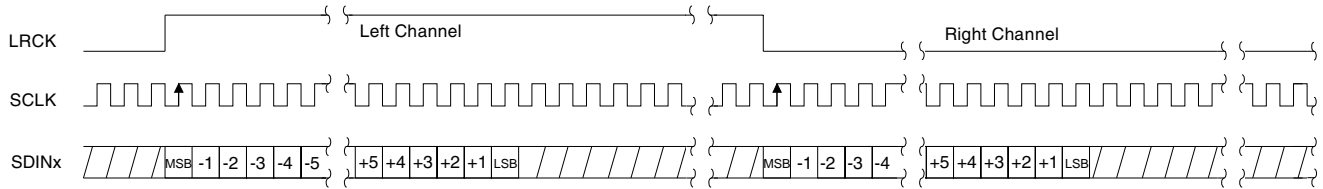
**Table 3. Mode Selection, Stand-Alone Mode Options**

DSD_EN (LRCK)	M2	M1	M0	DESCRIPTION
1	0	0	0	64x oversampled DSD data with a 4x MCLK to DSD data rate
1	0	0	1	64x oversampled DSD data with a 6x MCLK to DSD data rate
1	0	1	0	64x oversampled DSD data with a 8x MCLK to DSD data rate
1	0	1	1	64x oversampled DSD data with a 12x MCLK to DSD data rate
1	1	0	0	128x oversampled DSD data with a 2x MCLK to DSD data rate
1	1	0	1	128x oversampled DSD data with a 3x MCLK to DSD data rate
1	1	1	0	128x oversampled DSD data with a 4x MCLK to DSD data rate
1	1	1	1	128x oversampled DSD data with a 6x MCLK to DSD data rate

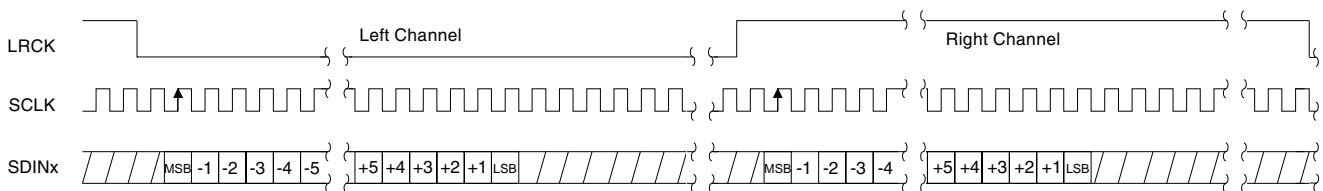
**Table 4. Direct Stream Digital (DSD), Stand-Alone Mode Options**

### 4.3 Digital Interface Formats

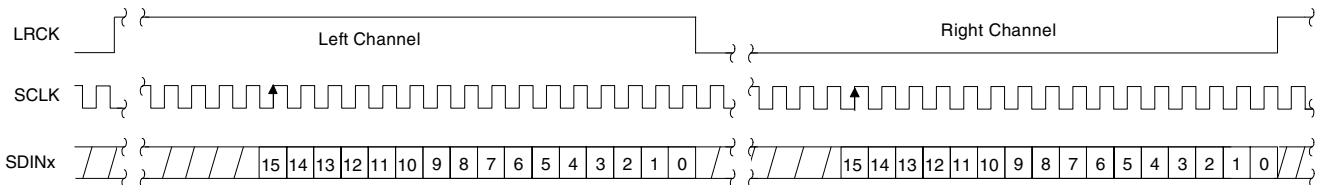
The serial port operates as a slave and supports the I<sup>2</sup>S, Left-justified, and Right-justified digital interface formats with varying bit depths from 16 to 24 as shown in Figures 7-12. Data is clocked into the DAC on the rising edge.



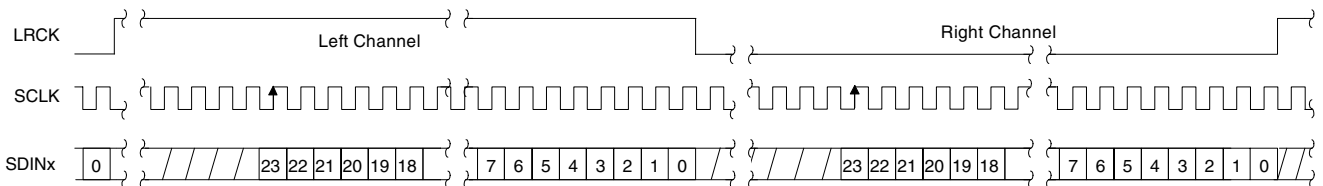
**Figure 7. Format 0 - Left-Justified up to 24-bit Data**



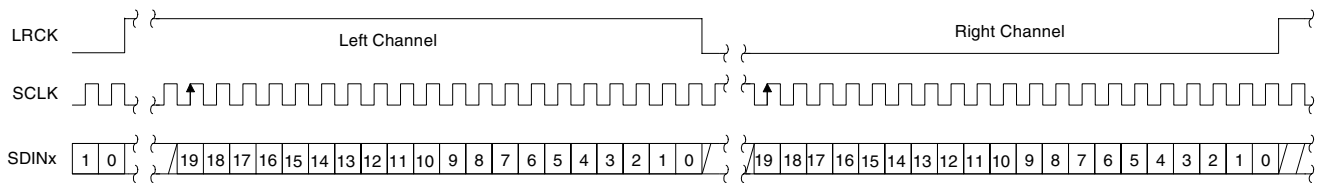
**Figure 8. Format 1 - I<sup>2</sup>S up to 24-bit Data**



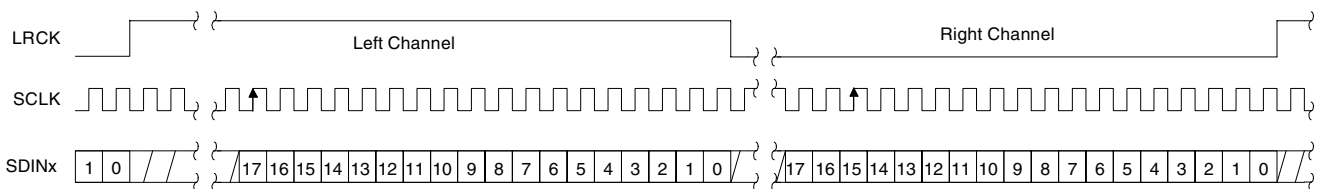
**Figure 9. Format 2 - Right-Justified 16-bit Data**



**Figure 10. Format 3 - Right-Justified 24-bit Data**



**Figure 11. Format 4 - Right-Justified 20-bit Data**



**Figure 12. Format 5 - Right-Justified 18-bit Data**

## 4.4 Oversampling Modes

The CS4362A operates in one of three oversampling modes based on the input sample rate. Mode selection is determined by the DSD\_EN, M3, and M2 pins in Hardware Mode or the FM bits in Software Mode. Single-speed mode supports input sample rates up to 50 kHz and uses a 128x oversampling ratio. Double-speed Mode supports input sample rates up to 100 kHz and uses an oversampling ratio of 64x. Quad-speed Mode supports input sample rates up to 200 kHz and uses an oversampling ratio of 32x.

## 4.5 Interpolation Filter

To accommodate the increasingly complex requirements of digital audio systems, the CS4362A incorporates selectable interpolation filters for each mode of operation. A “fast” and a “slow” roll-off filter is available in each of Single, Double, and Quad-Speed modes. These filters have been designed to accommodate a variety of musical tastes and styles. The FILT\_SEL bit is used to select which filter is used (see the “[Filter Plots](#)” on page 42 for more details).

When in Hardware Mode, only the “fast” roll-off filter is available.

Filter specifications can be found in [Section 2](#), and filter response plots can be found in [Figures 20 to 43](#).

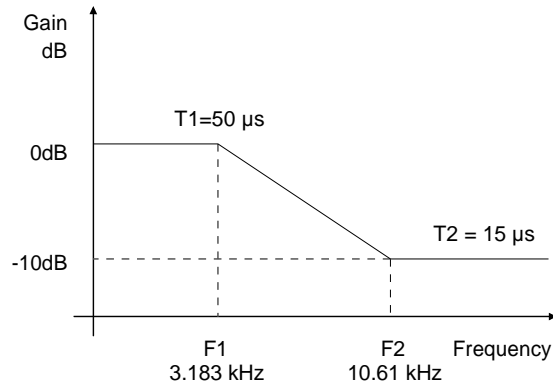
## 4.6 De-emphasis

The CS4362A includes on-chip digital de-emphasis filters. The de-emphasis feature is included to accommodate older audio recordings that utilize pre-emphasis equalization as a means of noise reduction. [Figure 13](#) shows the de-emphasis curve. The frequency response of the de-emphasis curve will scale proportionally with changes in sample rate ( $F_s$ ) if the input sample rate does not match the coefficient which has been selected.



In Software Mode, the required de-emphasis filter coefficients for 32 kHz, 44.1 kHz, or 48 kHz are selected via the de-emphasis control bits.

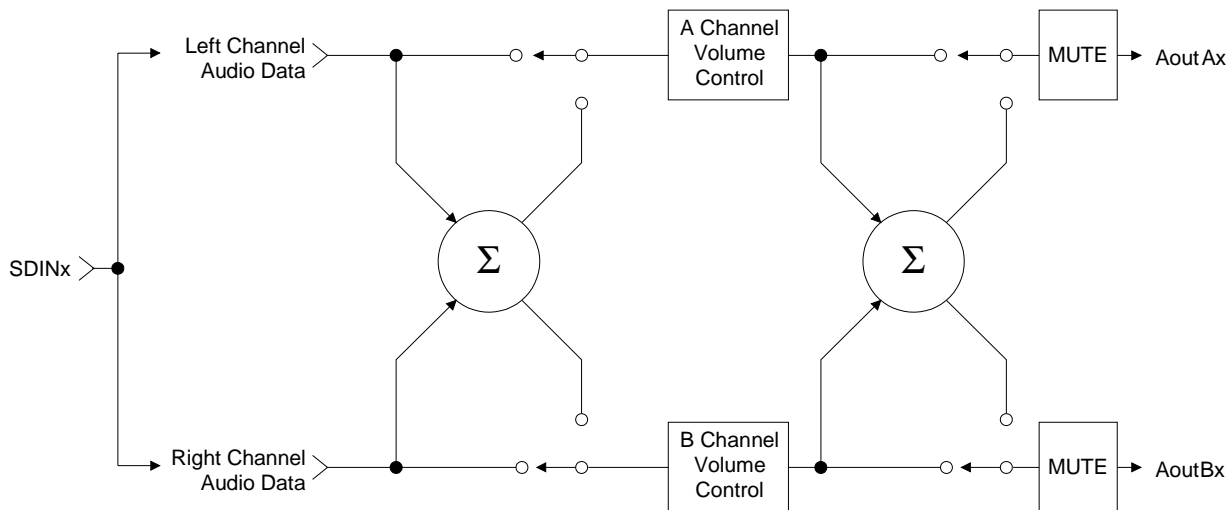
In Hardware Mode, only the 44.1 kHz coefficient is available (enabled through the M2 pin). If the input sample rate is not 44.1 kHz and de-emphasis has been selected, the corner frequencies of the de-emphasis filter will be scaled by a factor of the actual  $F_s$  over 44,100.



**Figure 13. De-Emphasis Curve**

## 4.7 ATAPI Specification

The CS4362A implements the channel mixing functions of the ATAPI CD-ROM specification. The ATAPI functions are applied per A-B pair. Refer to [Table 8 on page 41](#) and [Figure 14](#) for additional information.



**Figure 14. ATAPI Block Diagram (x = channel pair 1, 2, or 3)**

## 4.8 Direct Stream Digital (DSD) Mode

In Stand-alone Mode, DSD operation is selected by holding DSD\_EN(LRCK) high and applying the DSD data and clocks to the appropriate pins. The M[2:0] pins set the expected DSD rate and MCLK ratio.

In Control Port Mode, the FM bits set the device into DSD Mode (DSD\_EN pin is not required to be held high). The DIF register then controls the expected DSD rate and MCLK ratio.

During DSD operation, the PCM related pins should either be tied low or remain active with clocks (except LRCK in Stand-alone Mode). When the DSD related pins are not being used, they should either be tied static low or remain active with clocks (except M3 in Stand-alone Mode).

## 4.9 Grounding and Power Supply Arrangements

As with any high-resolution converter, the CS4362A requires careful attention to power supply and grounding arrangements if its potential performance is to be realized. The Typical Connection Diagram shows the recommended power arrangements, with VA, VD, VLC, and VLS connected to clean supplies. If the ground planes are split between digital ground and analog ground, the GND pins of the CS4362A should be connected to the analog ground plane.

All signals, especially clocks, should be kept away from the FILT+ and VQ pins in order to avoid unwanted coupling into the DAC.

### 4.9.1 Capacitor Placement

Decoupling capacitors should be placed as close to the DAC as possible, with the low-value ceramic capacitor being the closest. To further minimize impedance, these capacitors should be located on the same layer as the DAC. If desired, all supply pins with similar voltage ratings may be connected to the same supply, but a decoupling capacitor should still be placed on each supply pin.

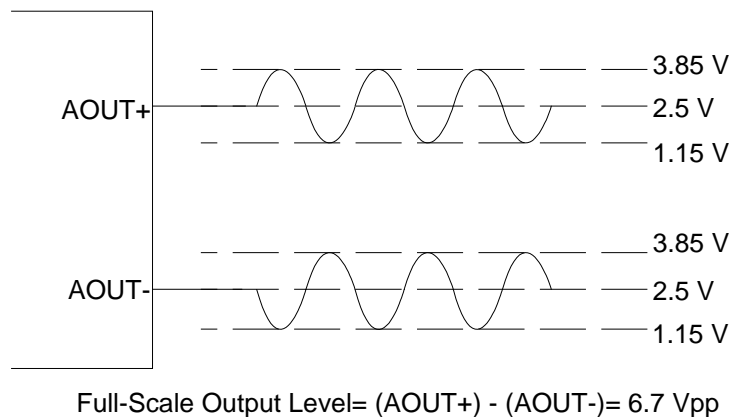
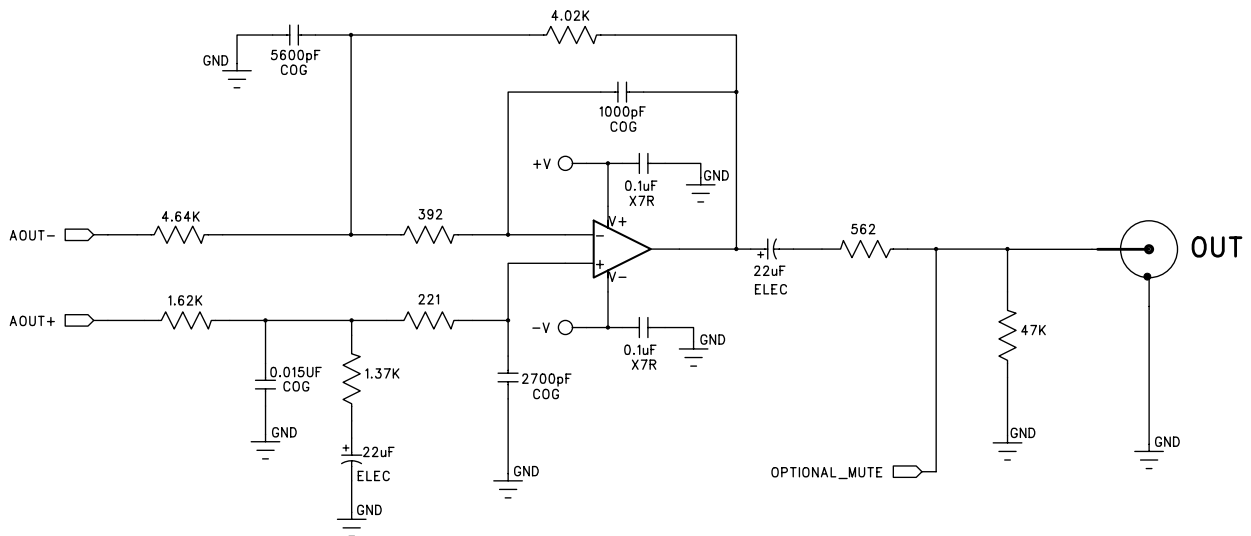
**Notes:** All decoupling capacitors should be referenced to analog ground.

The CDB4362A evaluation board demonstrates the optimum layout and power supply arrangements.

## 4.10 Analog Output and Filtering

The application note “Design Notes for a 2-pole Filter with Differential Input” discusses the second-order Butterworth filter and differential-to-single-ended converter which was implemented on the CS4362A evaluation board, CDB4362A, as seen in [Figure 16](#). The CS4362A does not include phase or amplitude compensation for an external filter. Therefore, the DAC system phase and amplitude response will be dependent on the external analog circuitry. The off-chip filter has been designed to attenuate the typical full-scale output level to below 2 Vrms.

[Figure 15](#) shows how the full-scale differential analog output level specification is derived.

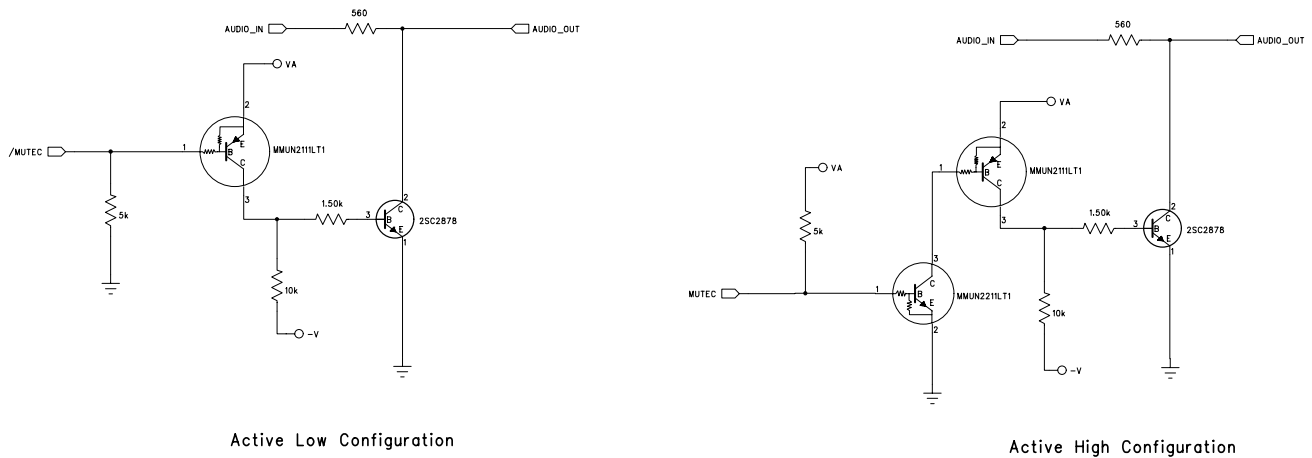

**Figure 15. Full-Scale Output**

**Figure 16. Recommended Output Filter**

## 4.11 Mute Control

The Mute Control pins go active during power-up initialization, muting, or if the MCLK-to-LRCK ratio is incorrect. These pins are intended to be used as control for external mute circuits to prevent the clicks and pops that can occur in any single-ended, single-supply system. The MUTEC output pins are high impedance at the time of reset. The external mute circuitry needs to be self biased into an active state in order to be muted during reset. Once reset has been released, the MUTEC pins are active high in hardware mode and the active state is set by the MUTEC+/- register in software mode (see [Section 6.3.4](#)).

[Figure 17](#) shows a single example of both an active high and an active low mute drive circuit. In these designs, the pull-up and pull-down resistors have been especially chosen to meet the input high/low threshold when used with the MMUN2111 and MMUN2211 internal bias resistances of 10 kΩ.

Use of the Mute Control function is not mandatory but recommended for designs requiring the absolute minimum in extraneous clicks and pops. Also, use of the Mute Control function can enable the system designer to achieve idle channel noise/signal-to-noise ratios which are only limited by the external mute circuit.



**Figure 17. Recommended Mute Circuitry**

## 4.12 Recommended Power-Up Sequence

### 4.12.1 Hardware Mode

1. Hold  $\overline{\text{RST}}$  low until the power supplies and configuration pins are stable, and the master and left/right clocks are locked to the appropriate frequencies, as discussed in Section 4.1. In this state, the registers are reset to the default settings, FILT+ will remain low, and VQ will be connected to VA/2. If RST can not be held low long enough the SDINx pins should remain static low until all other clocks are stable, and if possible the  $\overline{\text{RST}}$  should be toggled low again once the system is stable.
2. Bring  $\overline{\text{RST}}$  high. The device will remain in a low power state with FILT+ low and will initiate the Hardware power-up sequence after approximately 512 LRCK cycles in Single-Speed Mode (1024 LRCK cycles in Double-Speed Mode, and 2048 LRCK cycles in Quad-Speed Mode).

### 4.12.2 Software Mode

1. Hold  $\overline{\text{RST}}$  low until the power supply is stable, and the master and left/right clocks are locked to the appropriate frequencies, as discussed in Section 4.1. In this state, the registers are reset to the default settings; FILT+ will remain low, and VQ will be connected to VA/2.
2. Bring  $\overline{\text{RST}}$  high. The device will remain in a low-power state with FILT+ low for 512 LRCK cycles in Single-speed Mode (1024 LRCK cycles in Double-speed Mode, and 2048 LRCK cycles in Quad-speed Mode).
3. In order to reduce the chances of clicks and pops, perform a write to the CP\_EN bit prior to the completion of approximately 512 LRCK cycles in Single-speed Mode (1024 LRCK cycles in Double-speed Mode, and 2048 LRCK cycles in Quad-speed Mode). The desired register settings can be loaded while keeping the PDN bit set to 1. Set the RMP\_UP and RMP\_DN bits to 1; then set the format and mode control bits to the desired settings.

If more than the stated number of LRCK cycles passes before CPEN bit is written, the chip will enter Hardware Mode and begin to operate with the M0-M3 as the mode settings. CPEN bit may be written at anytime, even after the Hardware sequence has begun. It is advised that if the CPEN bit cannot be set in time, the SDINx pins should remain static low (this way, no audio data can be converted incorrectly by the Hardware Mode settings).

4. Set the PDN bit to 0. This will initiate the power-up sequence, which lasts approximately 50  $\mu\text{s}$ .

## 4.13 Recommended Procedure for Switching Operational Modes

For systems where the absolute minimum in clicks and pops is required, it is recommended that the MUTE bits are set prior to changing significant DAC functions (such as changing sample rates or clock sources). The mute bits may then be released after clocks have settled and the proper modes have been set.

It is required to have the device held in reset if the minimum high/low time specs of MCLK cannot be met during clock source changes.

## 4.14 Control Port Interface

The Control Port is used to load all the internal register settings in order to operate in Software Mode (see the “[Filter Plots](#)” on page 42). The operation of the Control Port may be completely asynchronous with the audio sample rate. However, to avoid potential interference problems, the Control Port pins should remain static if no operation is required.

The Control Port operates in one of two modes: I<sup>2</sup>C or SPI.

### 4.14.1 MAP Auto Increment

The device has MAP (memory address pointer) auto-increment capability enabled by the INCR bit (also the MSB) of the MAP. If INCR is set to 0, MAP will stay constant for successive I<sup>2</sup>C writes or reads and SPI writes. If INCR is set to 1, MAP will auto increment after each byte is written, allowing block reads or writes of successive registers.

### 4.14.2 I<sup>2</sup>C Mode

In the I<sup>2</sup>C Mode, data is clocked into and out of the bi-directional serial control data line, SDA, by the serial Control Port clock, SCL (see [Figure 18](#) for the clock to data relationship). There is no CS pin. Pin AD0 enables the user to alter the chip address (001100[AD0][R/W]) and should be tied to VLC or GND, as required, before powering up the device. If the device ever detects a high-to-low transition on the AD0/CS pin after power-up, SPI Mode will be selected.

#### 4.14.2.1 I<sup>2</sup>C Write

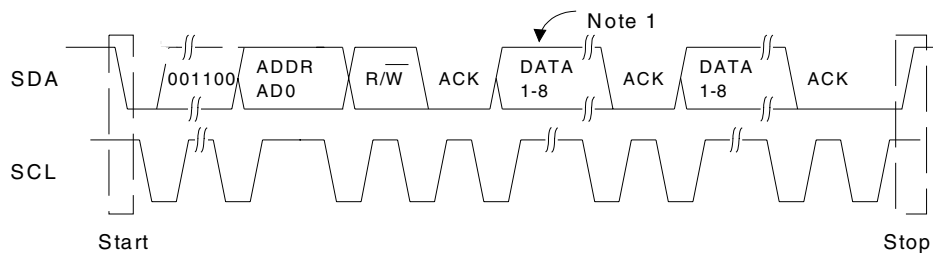
To write to the device, follow the procedure below while adhering to the Control Port Switching Specifications in [Section 2](#).

1. Initiate a START condition to the I<sup>2</sup>C bus followed by the address byte. The upper 6 bits must be 001100. The seventh bit must match the setting of the AD0 pin, and the eighth must be 0. The eighth bit of the address byte is the R/W bit.
2. Wait for an acknowledge (ACK) from the part; then write to the memory address pointer, MAP. This byte points to the register to be written.
3. Wait for an acknowledge (ACK) from the part; then write the desired data to the register pointed to by the MAP.
4. If the INCR bit (see [Section 4.14.1](#)) is set to 1, repeat the previous step until all the desired registers are written, then initiate a STOP condition to the bus.
5. If the INCR bit is set to 0 and further I<sup>2</sup>C writes to other registers are desired, it is necessary to initiate a repeated START condition and follow the procedure detailed from step 1. If no further writes to other registers are desired, initiate a STOP condition to the bus.

#### 4.14.2.2 I<sup>2</sup>C Read

To read from the device, follow the procedure below while adhering to the Control Port Switching Specifications.

1. Initiate a START condition to the I<sup>2</sup>C bus followed by the address byte. The upper 6 bits must be 001100. The seventh bit must match the setting of the AD0 pin, and the eighth must be 1. The eighth bit of the address byte is the R/W bit.
2. After transmitting an acknowledge (ACK), the device will then transmit the contents of the register pointed to by the MAP. The MAP register will contain the address of the last register written to the MAP, or the default address (see Section 4.14.1) if an I<sup>2</sup>C read is the first operation performed on the device.
3. Once the device has transmitted the contents of the register pointed to by the MAP, issue an ACK.
4. If the INCR bit is set to 1, the device will continue to transmit the contents of successive registers. Continue providing a clock and issue an ACK after each byte until all the desired registers are read; then initiate a STOP condition to the bus.
5. If the INCR bit is set to 0 and further I<sup>2</sup>C reads from other registers are desired, it is necessary to initiate a repeated START condition and follow the procedure detailed from steps 1 and 2 from the I<sup>2</sup>C Write instructions followed by step 1 of the I<sup>2</sup>C Read section. If no further reads from other registers are desired, initiate a STOP condition to the bus.



Note: If operation is a write, this byte contains the Memory Address Pointer, MAP.

**Figure 18. Control Port Timing, I<sup>2</sup>C Mode**

#### 4.14.3 SPI Mode

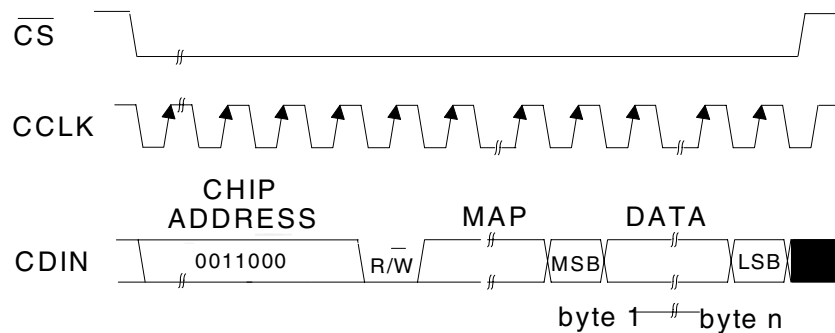
In SPI Mode, data is clocked into the serial control data line, CDIN, by the serial Control Port clock, CCLK (see Figure 19 for the clock-to-data relationship). There is no AD0 pin. Pin  $\overline{CS}$  is the chip select signal and is used to control SPI writes to the Control Port. When the device detects a high-to-low transition on the AD0/ $\overline{CS}$  pin after power-up, SPI Mode will be selected. All signals are inputs and data is clocked in on the rising edge of CCLK.

##### 4.14.3.1 SPI Write

To write to the device, follow the procedure below while adhering to the Control Port Switching Specifications in Section 2.

1. Bring  $\overline{CS}$  low.
2. The address byte on the CDIN pin must then be 00110000.
3. Write to the memory address pointer, MAP. This byte points to the register to be written.
4. Write the desired data to the register pointed to by the MAP.
5. If the INCR bit (see Section 4.14.1) is set to 1, repeat the previous step until all the desired registers are written, then bring  $\overline{CS}$  high.

6. If the INCR bit is set to 0 and further SPI writes to other registers are desired, it is necessary to bring  $\overline{CS}$  high, and follow the procedure detailed from step 1. If no further writes to other registers are desired, bring  $\overline{CS}$  high.



MAP = Memory Address Pointer

Figure 19. Control Port Timing, SPI Mode

#### 4.15 Memory Address Pointer (MAP)

7	6	5	4	3	2	1	0
INCR	Reserved	Reserved	MAP4	MAP3	MAP2	MAP1	MAP0
0	0	0	0	0	0	0	0

#### 4.16 INCR (Auto Map Increment Enable)

Default = '0'  
 0 - Disabled  
 1 - Enabled

##### 4.16.1 MAP4-0 (Memory Address Pointer)

Default = '00000'

## 5. REGISTER QUICK REFERENCE

Addr	Function	7	6	5	4	3	2	1	0
01h	Mode Control 1 default	CPEN 0	FREEZE 0	MCLKDIV 0	Reserved 0	DAC3_DIS 0	DAC2_DIS 0	DAC1_DIS 0	PDN 1
02h	Mode Control 2 default	Reserved 0	DIF2 0	DIF1 0	DIF0 0	Reserved 0	Reserved 0	Reserved 0	Reserved 0
03h	Mode Control 3 default	SZC1 1	SZC0 0	SNGLVOL 0	RMP_UP 0	MUTEC+/- 0	AMUTE 1	MUTEC1 0	MUTEC0 0
04h	Filter Control default	Reserved 0	Reserved 0	Reserved 0	FILT_SEL 0	Reserved 0	DEM1 0	DEM0 0	RMP_DN 0
05h	Invert Control default	Reserved 0	Reserved 0	INV_B3 0	INV_A3 0	INV_B2 0	INV_A2 0	INV_B1 0	INV_A1 0
06h	Mixing Control Pair 1 (AOUTx1) default	P1_A=B 0	P1ATAPI4 0	P1ATAPI3 1	P1ATAPI2 0	P1ATAPI1 0	P1ATAPI0 1	FM1 0	FM0 0
07h	Vol. Control A1 default	A1_MUTE 0	A1_VOL6 0	A1_VOL5 0	A1_VOL4 0	A1_VOL3 0	A1_VOL2 0	A1_VOL1 0	A1_VOL0 0
08h	Vol. Control B1 default	B1_MUTE 0	B1_VOL6 0	B1_VOL5 0	B1_VOL4 0	B1_VOL3 0	B1_VOL2 0	B1_VOL1 0	B1_VOL0 0
09h	Mixing Control Pair 2 (AOUTx2) default	P2_A=B 0	P2ATAPI4 0	P2ATAPI3 1	P2ATAPI2 0	P2ATAPI1 0	P2ATAPI0 1	Reserved 0	Reserved 0
0Ah	Vol. Control A2 default	A2_MUTE 0	A2_VOL6 0	A2_VOL5 0	A2_VOL4 0	A2_VOL3 0	A2_VOL2 0	A2_VOL1 0	A2_VOL0 0
0Bh	Vol. Control B2 default	B2_MUTE 0	B2_VOL6 0	B2_VOL5 0	B2_VOL4 0	B2_VOL3 0	B2_VOL2 0	B2_VOL1 0	B2_VOL0 0
0Ch	Mixing Control Pair 3 (AOUTx3) default	P3_A=B 0	P3ATAPI4 0	P3ATAPI3 1	P3ATAPI2 0	P3ATAPI1 0	P3ATAPI0 1	Reserved 0	Reserved 0
0Dh	Vol. Control A3 default	A3_MUTE 0	A3_VOL6 0	A3_VOL5 0	A3_VOL4 0	A3_VOL3 0	A3_VOL2 0	A3_VOL1 0	A3_VOL0 0
0Eh	Vol. Control B3 default	B3_MUTE 0	B3_VOL6 0	B3_VOL5 0	B3_VOL4 0	B3_VOL3 0	B3_VOL2 0	B3_VOL1 0	B3_VOL0 0
12h	Chip Revision default	PART4 0	PART3 1	PART2 0	PART1 1	PART0 0	REV2 x	REV1 x	REV0 x



## 6. REGISTER DESCRIPTION

**Note:** All registers are read/write in I<sup>2</sup>C Mode and write only in SPI, unless otherwise noted.

### 6.1 Mode Control 1 (Address 01h)

7	6	5	4	3	2	1	0
CPEN	FREEZE	MCLKDIV	Reserved	DAC3_DIS	DAC2_DIS	DAC1_DIS	PDN
0	0	0	0	0	0	0	1

#### 6.1.1 Control Port Enable (CPEN)

Default = 0  
 0 - Disabled  
 1 - Enabled

Function:

This bit defaults to 0, allowing the device to power-up in Stand-Alone Mode. The Control Port Mode can be accessed by setting this bit to 1. This will allow the operation of the device to be controlled by the registers and the pin definitions will conform to Control Port Mode. To accomplish a clean power-up, the user should write this bit within 10 ms following the release of Reset.

#### 6.1.2 Freeze Controls (FREEZE)

Default = 0  
 0 - Disabled  
 1 - Enabled

Function:

This function allows modifications to be made to the registers without the changes taking effect until the FREEZE is disabled. To make multiple changes in the Control Port registers take effect simultaneously, enable the FREEZE Bit, make all register changes, then Disable the FREEZE bit.

#### 6.1.3 Master Clock Divide Enable (MCLKDIV)

Default = 0  
 0 - Disabled  
 1 - Enabled

Function:

The MCLKDIV bit enables a circuit which divides the externally applied MCLK signal by 2 prior to all other internal circuitry.

#### 6.1.4 DAC Pair Disable (DACx\_DIS)

Default = 0  
 0 - DAC Pair x Enabled  
 1 - DAC Pair x Disabled

Function:

When the bit is set, the respective DAC channel pair (AOUTAx and AOUTBx) will remain in a reset state. It is advised that changes to these bits be made while the power-down (PDN) bit is enabled to eliminate the possibility of audible artifacts.

### 6.1.5 Power Down (PDN)

Default = 1  
 0 - Disabled  
 1 - Enabled

Function:

The entire device will enter a low-power state when this function is enabled, and the contents of the control registers are retained in this mode. The power-down bit defaults to 'enabled' on power-up and must be disabled before normal operation in Control Port Mode can occur.

## 6.2 Mode Control 2 (Address 02h)

7	6	5	4	3	2	1	0
Reserved 0	DIF2 0	DIF1 0	DIF0 0	Reserved 0	Reserved 0	Reserved 0	Reserved 0

### 6.2.1 Digital Interface Format (DIF)

Default = 000 - Format 0 (Left-Justified, up to 24-bit data)

Function:

These bits select the interface format for the serial audio input. The Functional Mode bits determine whether PCM or DSD Mode is selected.

**PCM Mode:** The required relationship between the Left/Right clock, serial clock and serial data is defined by the Digital Interface Format and the options are detailed in [Figures 7-12](#).

**Note:** While in PCM Mode, the DIF bits should only be changed when the power-down (PDN) bit is set to ensure proper switching from one mode to another.

DIF2	DIF1	DIF0	DESCRIPTION	Format	FIGURE
0	0	0	Left-Justified, up to 24-bit data	0	<a href="#">7</a>
0	0	1	I <sup>2</sup> S, up to 24-bit data	1	<a href="#">8</a>
0	1	0	Right-Justified, 16-bit data	2	<a href="#">9</a>
0	1	1	Right-Justified, 24-bit data	3	<a href="#">10</a>
1	0	0	Right-Justified, 20-bit data	4	<a href="#">11</a>
1	0	1	Right-Justified, 18-bit data	5	<a href="#">12</a>
1	1	0	Reserved	-	
1	1	1	Reserved	-	

**Table 5. Digital Interface Formats - PCM Mode**

**DSD Mode:** The relationship between the oversampling ratio of the DSD audio data and the required master clock-to-DSD-data-rate is defined by the Digital Interface Format pins.

DIF2	DIF1	DIFO	DESCRIPTION
0	0	0	64x oversampled DSD data with a 4x MCLK to DSD data rate
0	0	1	64x oversampled DSD data with a 6x MCLK to DSD data rate
0	1	0	64x oversampled DSD data with a 8x MCLK to DSD data rate
0	1	1	64x oversampled DSD data with a 12x MCLK to DSD data rate
1	0	0	128x oversampled DSD data with a 2x MCLK to DSD data rate
1	0	1	128x oversampled DSD data with a 3x MCLK to DSD data rate
1	1	0	128x oversampled DSD data with a 4x MCLK to DSD data rate
1	1	1	128x oversampled DSD data with a 6x MCLK to DSD data rate

**Table 6. Digital Interface Formats - DSD Mode**

### 6.3 Mode Control 3 (Address 03h)

7	6	5	4	3	2	1	0
SZC1	SZC0	SNGLVOL	RMP_UP	MUTEC+/-	AMUTE	MUTEC1	MUTEC0
1	0	0	0	0	1	0	0

#### 6.3.1 Soft Ramp and Zero Cross Control (SZC)

Default = 10

00 - Immediate Change

01 - Zero Cross

10 - Soft Ramp

11 - Soft Ramp on Zero Crossings

Function:

##### Immediate Change

When Immediate Change is selected, all level changes will take effect immediately in one step.

##### Zero Cross

Zero Cross Enable dictates that signal level changes, either by attenuation changes or muting, will occur on a signal zero crossing to minimize audible artifacts. The requested level change will occur after a time-out period between 512 and 1024 sample periods (10.7 ms to 21.3 ms at 48 kHz sample rate) if the signal does not encounter a zero crossing. The zero cross function is independently monitored and implemented for each channel.

##### Soft Ramp

Soft Ramp allows level changes, both muting and attenuation, to be implemented by incrementally ramping, in 1/8 dB steps, from the current level to the new level at a rate of 1 dB per 8 left/right clock periods.

##### Soft Ramp on Zero Crossing

Soft Ramp and Zero Cross Enable dictates that signal level changes, either by attenuation changes or muting, will occur in 1/8 dB steps and be implemented on a signal zero crossing. The 1/8 dB level change will occur after a time-out period between 512 and 1024 sample periods (10.7 ms to 21.3 ms at 48 kHz sample rate) if the signal does not encounter a zero crossing. The zero cross function is independently monitored and implemented for each channel.

### 6.3.2 *Single Volume Control (SNGLVOL)*

Default = 0  
0 - Disabled  
1 - Enabled

Function:

The individual channel volume levels are independently controlled by their respective Volume Control Bytes when this function is disabled. The volume on all channels is determined by the A1 Channel Volume Control Byte, and the other Volume Control Bytes are ignored when this function is enabled.

### 6.3.3 *Soft Volume Ramp-Up After Error (RMP\_UP)*

Default = 0  
0 - Disabled  
1 - Enabled

Function:

An un-mute will be performed after a LRCK/MCLK ratio change or error, and after changing the Functional Mode. When this feature is enabled, this un-mute is affected, similar to attenuation changes, by the Soft and Zero Cross bits in the Mode Control 3 register. When disabled, an immediate un-mute is performed in these instances.

**Notes:** For best results, it is recommended that this feature be used in conjunction with the RMP\_DN bit.

### 6.3.4 *Mutec Polarity (MUTEC+/-)*

Default = 0  
0 - Active High  
1 - Active Low

Function:

The active polarity of the MUTEC pin(s) is determined by this register. When set to 0 (default), the MUTEC pins are high when active. When set to 1 the MUTEC pin(s) are low when active.

**Note:** During reset the MUTEC output pins are high impedance and the external mute circuitry will need to be self biased into an active state, see [Section 4.11](#). Once reset has been released, the MUTEC outputs' active polarity will be set by this bit.

### 6.3.5 *Auto-Mute (AMUTE)*

Default = 1  
0 - Disabled  
1 - Enabled

Function:

The Digital-to-Analog converter output will mute following the reception of 8192 consecutive audio samples of static 0 or -1. A single sample of non-static data will release the mute. Detection and muting is done independently for each channel. The quiescent voltage on the output will be retained, and the Mute Control pin will go active during the mute period. The muting function is affected, similar to volume control changes, by the Soft and Zero Cross bits in the Mode Control 3 register.

### 6.3.6 Mute Pin Control (MUTEC1, MUTEC0)

Default = 00

- 00 - Six mute control signals
- 01, 10 - One mute control signal
- 11 - Three mute control signals

Function:

Selects how the internal mute control signals are routed to the MUTEC1 through MUTEC6 pins. When set to '00', there is one mute control signal for each channel: AOUT1A on MUTEC1, AOUT1B on MUTEC2, etc. When set to '01' or '10', there is a single mute control signal on the MUTEC1 pin. When set to '11', there are three mute control signals, one for each stereo pair: AOUT1A and AOUT1B on MUTEC1, AOUT2A and AOUT2B on MUTEC2, and AOUT3A and AOUT3B on MUTEC3.

## 6.4 Filter Control (Address 04h)

7	6	5	4	3	2	1	0
Reserved	Reserved	Reserved	FILT_SEL	Reserved	DEM1	DEM0	RMP_DN
0	0	0	0	0	0	0	0

### 6.4.1 Interpolation Filter Select (FILT\_SEL)

Default = 0

- 0 - Fast roll-off
- 1 - Slow roll-off

Function:

This function allows the user to select whether the interpolation filter has a fast or slow roll off. For filter characteristics, please see [Section 2](#).

### 6.4.2 De-Emphasis Control (DEM)

Default = 00

- 00 - Disabled
- 01 - 44.1 kHz
- 10 - 48 kHz
- 11 - 32 kHz

Function:

Selects the appropriate digital filter to maintain the standard 15  $\mu$ s/50  $\mu$ s digital de-emphasis filter response at 32, 44.1 or 48 kHz sample rates. (see [Figure 13](#))

De-emphasis is only available in Single-Speed Mode.

### 6.4.3 Soft Ramp-Down Before Filter Mode Change (RMP\_DN)

Default = 0

- 0 - Disabled
- 1 - Enabled

Function:

If either the FILT\_SEL or DEM bits are changed, the DAC will stop conversion for a period of time to change filter values. This bit selects how the data is effected prior to and after the change of the filter val-

ues. When this bit is enabled, the DAC will ramp down the volume prior to a filter-mode change and ramp from mute to the original volume value after a filter-mode change according to the settings of the Soft and Zero Cross bits in the Mode Control 3 register. When disabled, an immediate mute and unmute is performed.

Loss of clocks or a change in the FM bits will always cause an immediate mute; unmute in these conditions is affected by the RMP\_UP bit.

**Note:** For best results, it is recommended that this feature be used in conjunction with the RMP\_UP bit.

## 6.5 Invert Control (Address 05h)

7	6	5	4	3	2	1	0
Reserved	Reserved	INV_B3	INV_A3	INV_B2	INV_A2	INV_B1	INV_A1
0	0	0	0	0	0	0	0

### 6.5.1 Invert Signal Polarity (Inv\_Xx)

Default = 0  
 0 - Disabled  
 1 - Enabled

Function:

When enabled, these bits will invert the signal polarity of their respective channels.

## 6.6 Mixing Control Pair 1 (Channels A1 & B1)(Address 06h) Mixing Control Pair 2 (Channels A2 & B2)(Address 09h) Mixing Control Pair 3 (Channels A3 & B3)(Address 0Ch)

7	6	5	4	3	2	1	0
Px_A=B	PxATAPI4	PxATAPI3	PxATAPI2	PxATAPI1	PxATAPI0	PxFM1	PxFM0
0	0	1	0	0	1	0	0

### 6.6.1 Channel A Volume = Channel B Volume (A=B)

Default = 0  
 0 - Disabled  
 1 - Enabled

Function:

The AOUTAx and AOUTBx volume levels are independently controlled by the A and the B Channel Volume Control Bytes when this function is disabled. The volume on both AOUTAx and AOUTBx are determined by the A Channel Attenuation and Volume Control Bytes (per A-B pair), and the B Channel Bytes are ignored when this function is enabled.

### 6.6.2 ATAPI Channel Mixing and Muting (ATAPI)

Default = 01001 - AOUTAx=aL, AOUTBx=bR (Stereo)

Function:

The CS4362A implements the channel mixing functions of the ATAPI CD-ROM specification. The ATAPI functions are applied per A-B pair. Refer to [Table 7](#) and [Figure 14](#) for additional information.

ATAPI4	ATAPI3	ATAPI2	ATAPI1	ATAPI0	AOUTAx	AOUTBx
0	0	0	0	0	MUTE	MUTE
0	0	0	0	1	MUTE	bR
0	0	0	1	0	MUTE	bL
0	0	0	1	1	MUTE	b[(L+R)/2]
0	0	1	0	0	aR	MUTE
0	0	1	0	1	aR	bR
0	0	1	1	0	aR	bL
0	0	1	1	1	aR	b[(L+R)/2]
0	1	0	0	0	aL	MUTE
0	1	0	0	1	aL	bR
0	1	0	1	0	aL	bL
0	1	0	1	1	aL	b[(L+R)/2]
0	1	1	0	0	a[(L+R)/2]	MUTE
0	1	1	0	1	a[(L+R)/2]	bR
0	1	1	1	0	a[(L+R)/2]	bL
0	1	1	1	1	a[(L+R)/2]	b[(L+R)/2]
1	0	0	0	0	MUTE	MUTE
1	0	0	0	1	MUTE	bR
1	0	0	1	0	MUTE	bL
1	0	0	1	1	MUTE	[(aL+bR)/2]
1	0	1	0	0	aR	MUTE
1	0	1	0	1	aR	bR
1	0	1	1	0	aR	bL
1	0	1	1	1	aR	[(bL+aR)/2]
1	1	0	0	0	aL	MUTE
1	1	0	0	1	aL	bR
1	1	0	1	0	aL	bL
1	1	0	1	1	aL	[(aL+bR)/2]
1	1	1	0	0	[(aL+bR)/2]	MUTE
1	1	1	0	1	[(aL+bR)/2]	bR
1	1	1	1	0	[(bL+aR)/2]	bL
1	1	1	1	1	[(aL+bR)/2]	[(aL+bR)/2]

Table 7. ATAPI Decode

### 6.6.3 Functional Mode (FM)

Default = 00

00 - Single-Speed Mode (4 to 50 kHz sample rates)

01 - Double-Speed Mode (50 to 100 kHz sample rates)

10 - Quad-Speed Mode (100 to 200 kHz sample rates)

11 - Direct Stream Digital Mode

Function:

Selects the required range of input sample rates or DSD Mode. All DAC pairs are required to be set to the same functional mode setting before a speed-mode change is accepted. When DSD Mode is selected for any channel pair, all pairs switch to DSD Mode.

### 6.7 Volume Control (Addresses 07h, 08h, 0Ah, 0Bh, 0Dh, 0Eh)

7	6	5	4	3	2	1	0
xx_MUTE	xx_VOL6	xx_VOL5	xx_VOL4	xx_VOL3	xx_VOL2	xx_VOL1	xx_VOL0
0	0	0	0	0	0	0	0

**Note:** These six registers provide individual volume and mute control for each of the six channels.

The values for “xx” in the bit fields above are as follows:

Register address 07h - xx = A1

Register address 08h - xx = B1

Register address 0Ah - xx = A2

Register address 0Bh - xx = B2

Register address 0Dh - xx = A3

Register address 0Eh - xx = B3

#### 6.7.1 Mute (MUTE)

Default = 0

0 - Disabled

1 - Enabled

Function:

The Digital-to-Analog converter output will mute when enabled. The quiescent voltage on the output will be retained. The muting function is affected, similarly to attenuation changes, by the Soft and Zero Cross bits. The MUTE pins will go active during the mute period according to the MUTEC bits.



### 6.7.2 Volume Control (XX\_VOL)

Default = 0 (No attenuation)

Function:

The Digital Volume Control registers allow independent control of the signal levels in 1 dB increments from 0 to -127 dB. Volume settings are decoded as shown in [Table 8](#). The volume changes are implemented as dictated by the Soft and Zero Cross bits. All volume settings less than -127 dB are equivalent to enabling the MUTE bit.

Binary Code	Decimal Value	Volume Setting
0 0 0 0 0 0 0	0	0 dB
0 0 1 0 1 0 0	20	-20 dB
0 1 0 1 0 0 0	40	-40 dB
0 1 1 1 1 0 0	60	-60 dB
1 0 1 1 0 1 0	90	-90 dB

**Table 8. Example Digital Volume Settings**

### 6.8 Chip Revision (Address 12h)

7	6	5	4	3	2	1	0
PART4	PART3	PART2	PART1	PART0	REV2	REV1	REV0
0	1	0	1	0	-	-	-

#### 6.8.1 Part Number ID (PART) [Read Only]

01010 - CS4362A

#### 6.8.2 Revision ID (REV) [Read Only]

000 - Revision A

001 - Revision B

Function:

This read-only register can be used to identify the model and revision number of the device.

## 7. FILTER PLOTS

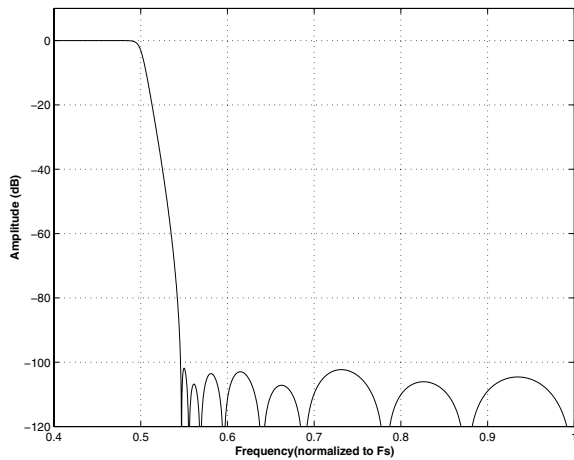


Figure 20. Single-Speed (fast) Stopband Rejection

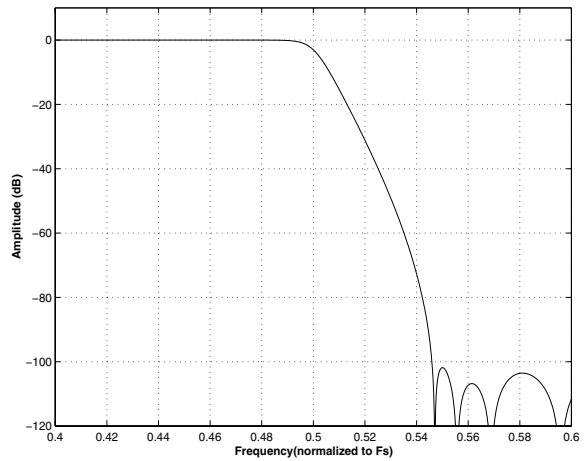


Figure 21. Single-Speed (fast) Transition Band

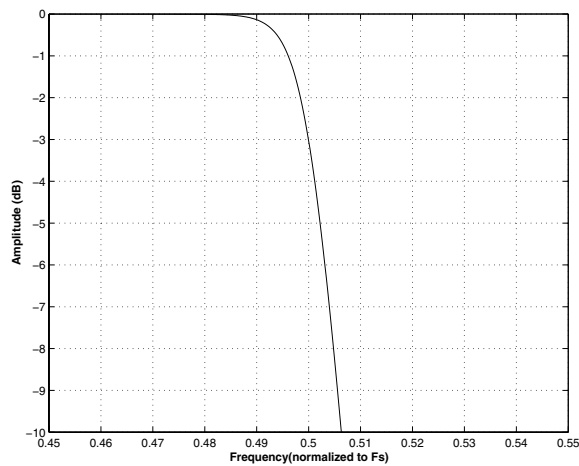


Figure 22. Single-Speed (fast) Transition Band (detail)

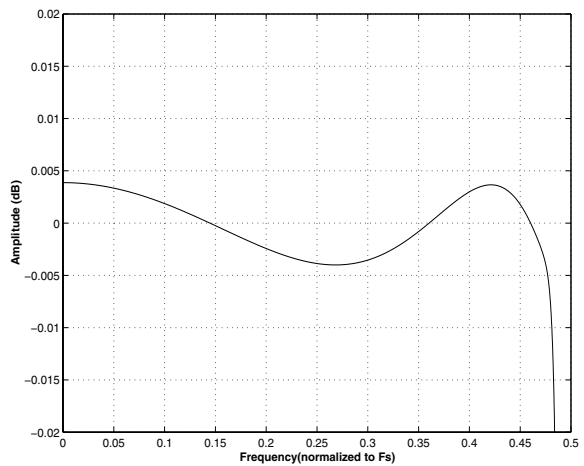


Figure 23. Single-Speed (fast) Passband Ripple

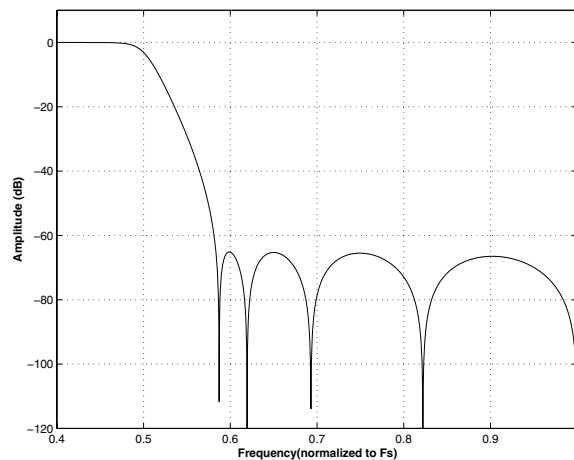


Figure 24. Single-Speed (slow) Stopband Rejection

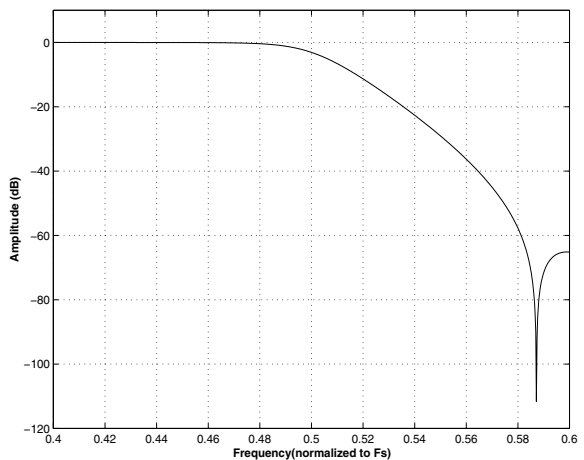
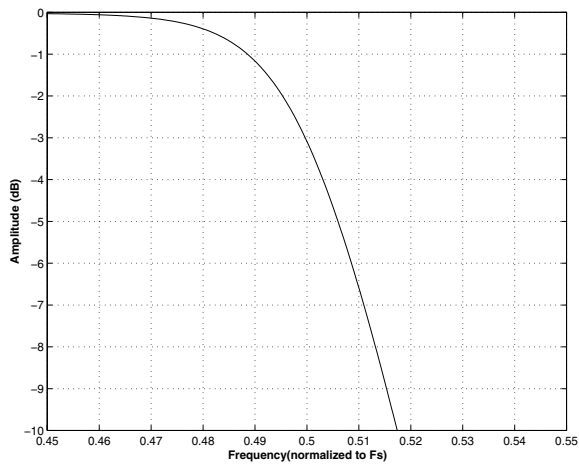
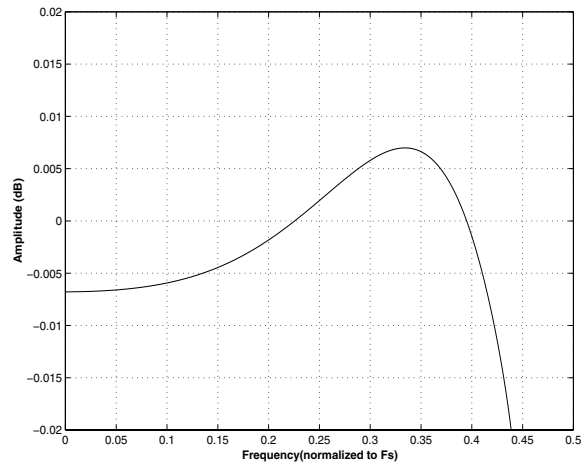
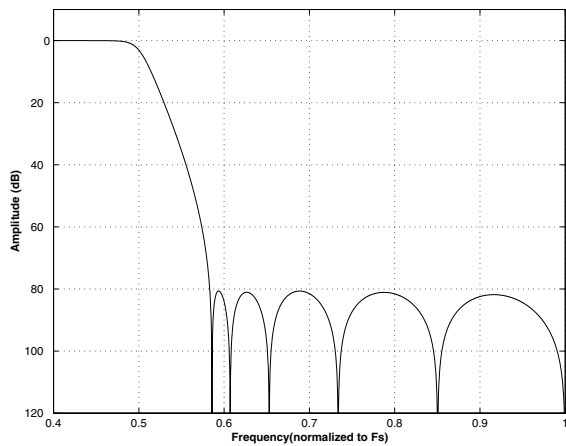
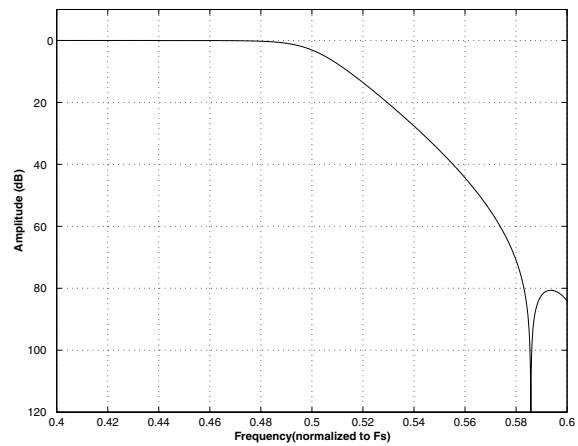
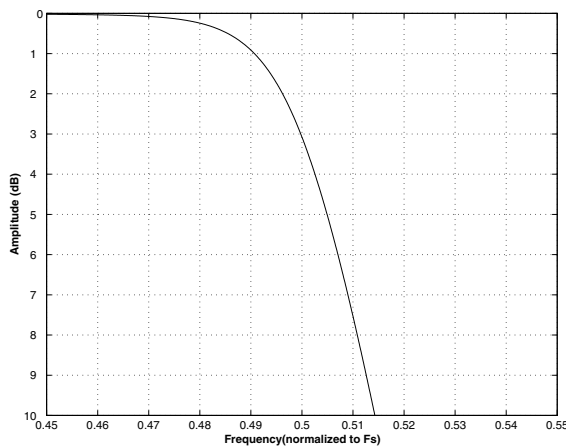
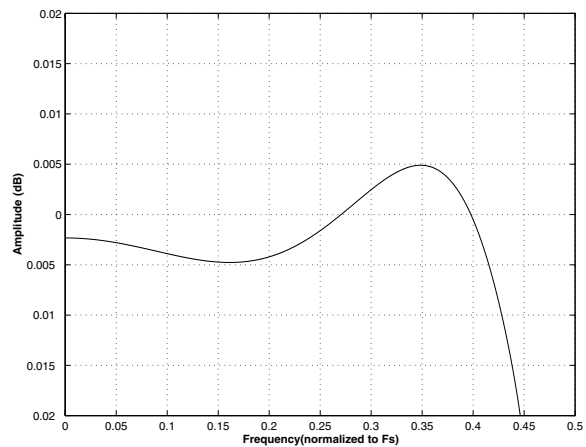
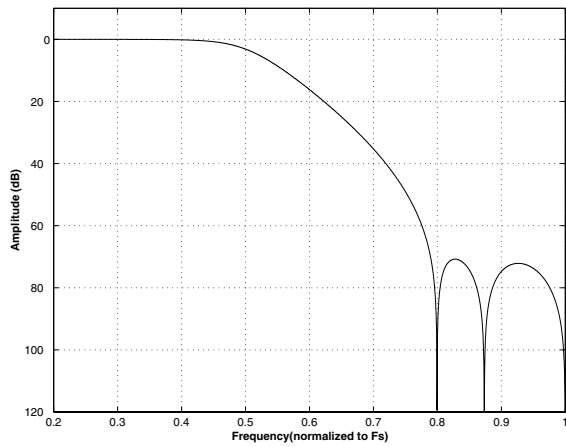
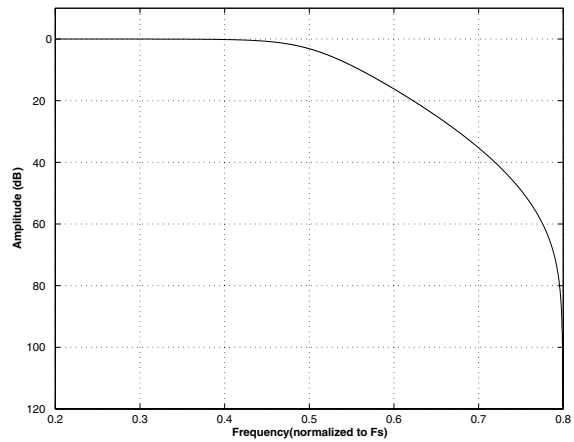
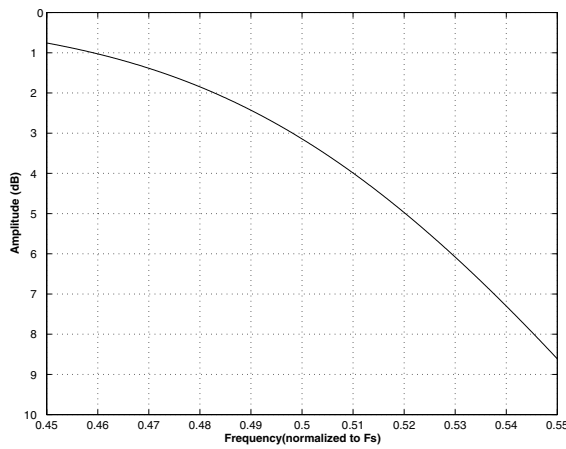
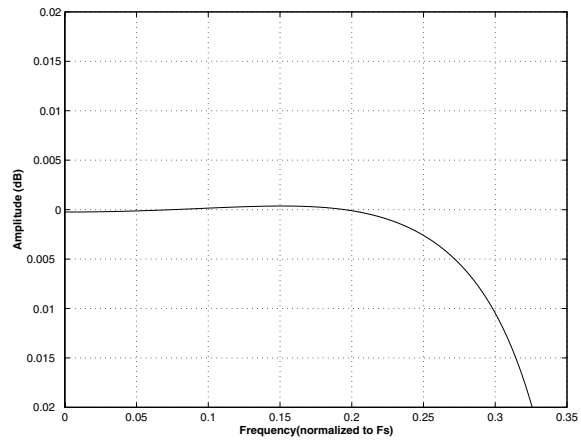
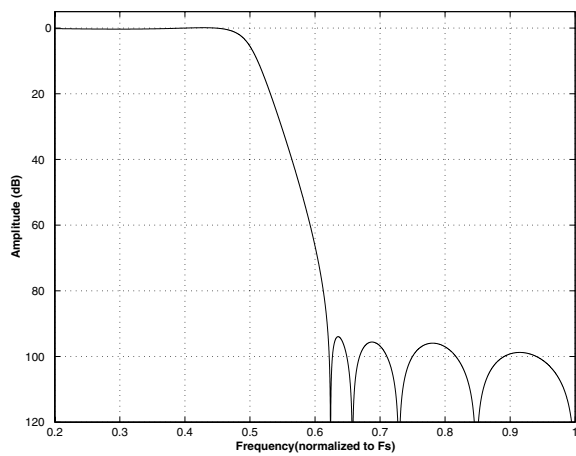
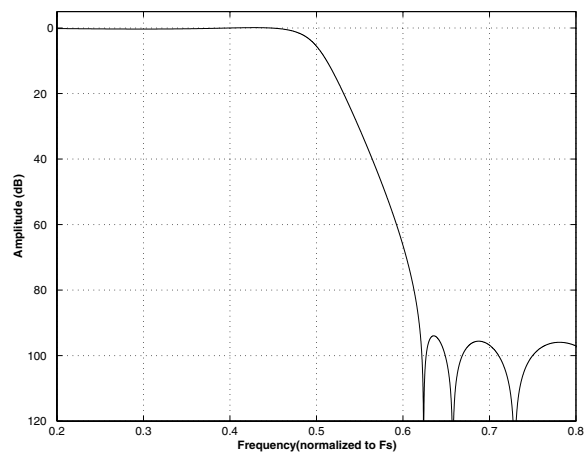
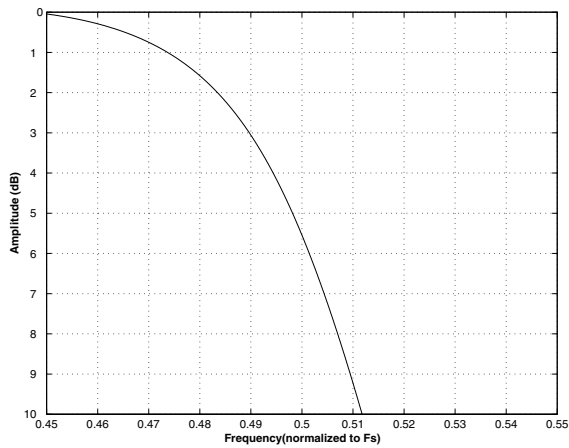
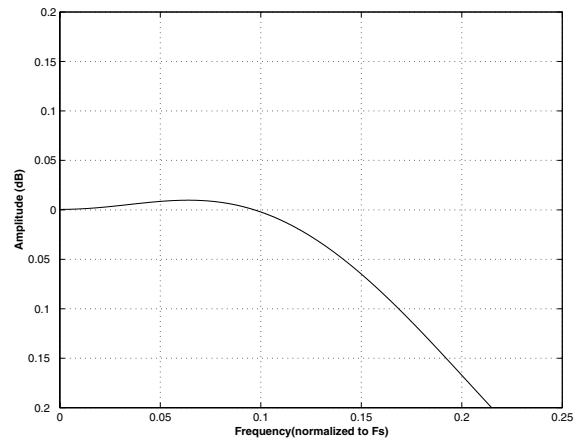
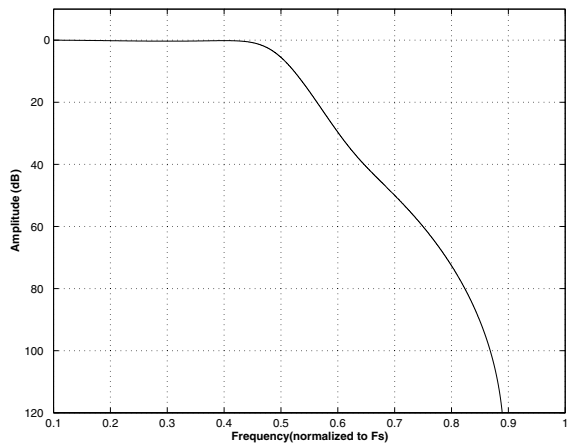
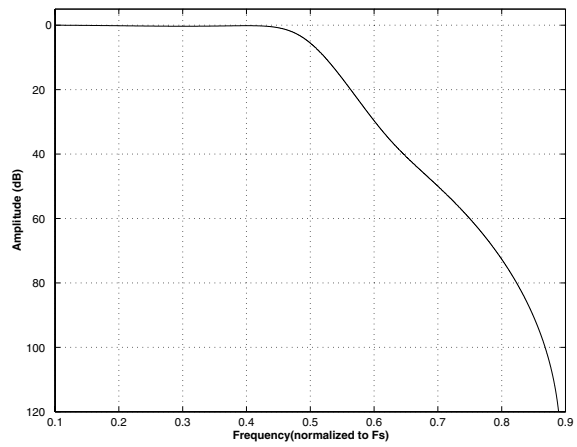
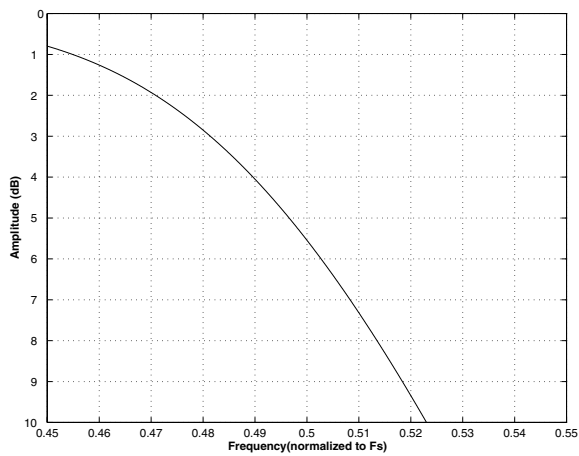
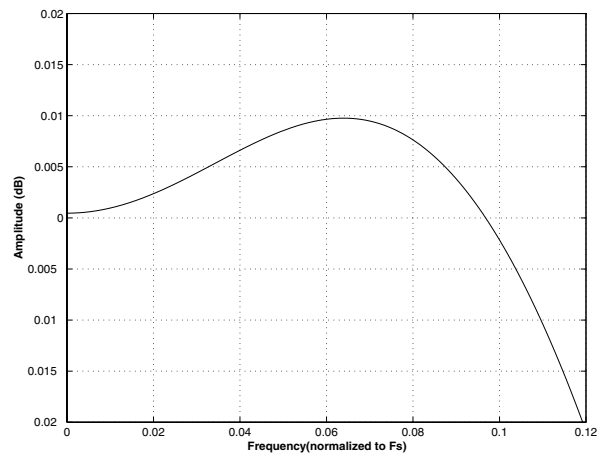


Figure 25. Single-Speed (slow) Transition Band


**Figure 26. Single-Speed (slow) Transition Band (detail)**

**Figure 27. Single-Speed (slow) Passband Ripple**

**Figure 28. Double-Speed (fast) Stopband Rejection**

**Figure 29. Double-Speed (fast) Transition Band**

**Figure 30. Double-Speed (fast) Transition Band (detail)**

**Figure 31. Double-Speed (fast) Passband Ripple**


**Figure 32. Double-Speed (slow) Stopband Rejection**

**Figure 33. Double-Speed (slow) Transition Band**

**Figure 34. Double-Speed (slow) Transition Band (detail)**

**Figure 35. Double-Speed (slow) Passband Ripple**

**Figure 36. Quad-Speed (fast) Stopband Rejection**

**Figure 37. Quad-Speed (fast) Transition Band**


**Figure 38. Quad-Speed (fast) Transition Band (detail)**

**Figure 39. Quad-Speed (fast) Passband Ripple**

**Figure 40. Quad-Speed (slow) Stopband Rejection**

**Figure 41. Quad-Speed (slow) Transition Band**

**Figure 42. Quad-Speed (slow) Transition Band (detail)**

**Figure 43. Quad-Speed (slow) Passband Ripple**

## 8. PARAMETER DEFINITIONS

### **Total Harmonic Distortion + Noise (THD+N)**

The ratio of the rms value of the signal to the rms sum of all other spectral components over the specified bandwidth (typically 10 Hz to 20 kHz), including distortion components. Expressed in decibels.

### **Dynamic Range**

The ratio of the full-scale rms value of the signal to the rms sum of all other spectral components over the specified bandwidth. Dynamic range is a signal-to-noise measurement over the specified bandwidth made with a -60 dBFS signal. 60 dB is then added to the resulting measurement to refer the measurement to full scale. This technique ensures that the distortion components are below the noise level and do not affect the measurement. This measurement technique has been accepted by the Audio Engineering Society, AES17-1991, and the Electronic Industries Association of Japan, EIAJ CP-307.

### **Interchannel Isolation**

A measure of crosstalk between the left and right channels. Measured for each channel at the converter's output with all zeros to the input under test and a full-scale signal applied to the other channel. Units in decibels.

### **Interchannel Gain Mismatch**

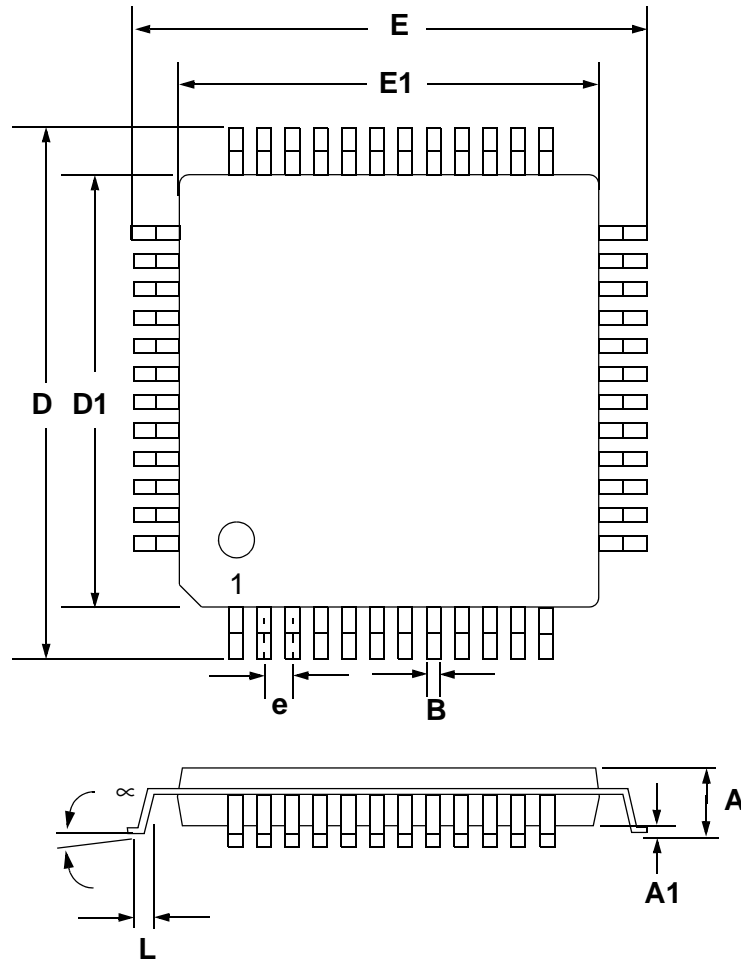
The gain difference between left and right channels. Units in decibels.

### **Gain Error**

The deviation from the nominal full-scale analog output for a full-scale digital input.

### **Gain Drift**

The change in gain value with temperature. Units in ppm/°C.

**9. PACKAGE DIMENSIONS**
**48L LQFP PACKAGE DRAWING**


DIM	INCHES			MILLIMETERS		
	MIN	NOM	MAX	MIN	NOM	MAX
A	---	0.055	0.063	---	1.40	1.60
A1	0.002	0.004	0.006	0.05	0.10	0.15
B	0.007	0.009	0.011	0.17	0.22	0.27
D	0.343	0.354	0.366	8.70	9.0 BSC	9.30
D1	0.272	0.28	0.280	6.90	7.0 BSC	7.10
E	0.343	0.354	0.366	8.70	9.0 BSC	9.30
E1	0.272	0.28	0.280	6.90	7.0 BSC	7.10
e*	0.016	0.020	0.024	0.40	0.50 BSC	0.60
L	0.018	0.24	0.030	0.45	0.60	0.75
μ	0.000°	4°	7.000°	0.00°	4°	7.00°

\* Nominal pin pitch is 0.50 mm  
 Controlling dimension is mm.  
 JEDEC Designation: MS022

## 10. ORDERING INFORMATION

Product	Description	Package	Pb-Free	Grade	Temp Range	Container	Order #
CS4362A	114 dB, 192 kHz 6-channel D/A Converter	48-pin LQFP	YES	Commercial	-40°C to +85°C	Tray	CS4362A-CQZ
						Tape & Reel	CS4362A-CQZR
				Automotive	-40°C to +105°C	Tray	CS4362A-DQZ
						Tape & Reel	CS4362A-DQZR
CDB4362A	CS4362A Evaluation Board		-	-	-	-	CDB4362A

## 11. REFERENCES

1. *How to Achieve Optimum Performance from Delta-Sigma A/D & D/A Converters*, by Steven Harris. Paper presented at the 93rd Convention of the Audio Engineering Society, October 1992.
2. CDB4362A data sheet, available at <http://www.cirrus.com>.
3. *Design Notes for a 2-Pole Filter with Differential Input*, by Steven Green. Cirrus Logic Application Note AN48.
4. *The I<sup>2</sup>C Bus Specification: Version 2.0*, Philips Semiconductors, December 1998  
<http://www.semiconductors.philips.com>.



## 12. REVISION HISTORY

Release	Changes
PP1	Updated output impedance spec in <a href="#">"DAC Analog Characteristics - Automotive (-DQZ)"</a> on page 10. Improved interchannel isolation spec in <a href="#">"DAC Analog Characteristics - Automotive (-DQZ)"</a> on page 10.
PP2	Corrected package type.
F1	Corrected register description in <a href="#">"DAC Pair Disable (DACx_DIS)"</a> on page 33. Added note to <a href="#">"Digital Interface Format (DIF)"</a> on page 34. Added PCM mode format changeable in reset only to <a href="#">"Mode Select"</a> on page 21. Updated ambient operating temperature range for Commercial and Automotive grade. Updated <a href="#">"DAC Analog Characteristics - Commercial (-CQZ)"</a> on page 9. Updated <a href="#">"DAC Analog Characteristics - Automotive (-DQZ)"</a> on page 10. Updated <a href="#">"Power and Thermal Characteristics"</a> on page 11. Updated <a href="#">"Digital Characteristics"</a> on page 14. Updated Legal Information under <a href="#">"IMPORTANT NOTICE"</a> on page 50
F2	Updated MUTE <sub>C</sub> pin description in <a href="#">"Pin Description"</a> on page 6. Updated <a href="#">"Mute Control"</a> on page 27. Updated <a href="#">"Mute<sub>C</sub> Polarity (MUTE<sub>C</sub>+/-)"</a> on page 36.

---

## Contacting Cirrus Logic Support

For all product questions and inquiries, contact a Cirrus Logic Sales Representative.

To find the one nearest you, go to [www.cirrus.com](http://www.cirrus.com).

---

### IMPORTANT NOTICE

Cirrus Logic, Inc. and its subsidiaries ("Cirrus") believe that the information contained in this document is accurate and reliable. However, the information is subject to change without notice and is provided "AS IS" without warranty of any kind (express or implied). Customers are advised to obtain the latest version of relevant information to verify, before placing orders, that information being relied on is current and complete. All products are sold subject to the terms and conditions of sale supplied at the time of order acknowledgment, including those pertaining to warranty, indemnification, and limitation of liability. No responsibility is assumed by Cirrus for the use of this information, including use of this information as the basis for manufacture or sale of any items, or for infringement of patents or other rights of third parties. This document is the property of Cirrus and by furnishing this information, Cirrus grants no license, express or implied under any patents, mask work rights, copyrights, trademarks, trade secrets or other intellectual property rights. Cirrus owns the copyrights associated with the information contained herein and gives consent for copies to be made of the information only for use within your organization with respect to Cirrus integrated circuits or other products of Cirrus. This consent does not extend to other copying such as copying for general distribution, advertising or promotional purposes, or for creating any work for resale.

CERTAIN APPLICATIONS USING SEMICONDUCTOR PRODUCTS MAY INVOLVE POTENTIAL RISKS OF DEATH, PERSONAL INJURY, OR SEVERE PROPERTY OR ENVIRONMENTAL DAMAGE ("CRITICAL APPLICATIONS"). CIRRUS PRODUCTS ARE NOT DESIGNED, AUTHORIZED OR WARRANTED FOR USE IN PRODUCTS SURGICALLY IMPLANTED INTO THE BODY, AUTOMOTIVE SAFETY OR SECURITY DEVICES, LIFE SUPPORT PRODUCTS OR OTHER CRITICAL APPLICATIONS. INCLUSION OF CIRRUS PRODUCTS IN SUCH APPLICATIONS IS UNDERSTOOD TO BE FULLY AT THE CUSTOMER'S RISK AND CIRRUS DISCLAIMS AND MAKES NO WARRANTY, EXPRESS, STATUTORY OR IMPLIED, INCLUDING THE IMPLIED WARRANTIES OF MERCHANTABILITY AND FITNESS FOR PARTICULAR PURPOSE, WITH REGARD TO ANY CIRRUS PRODUCT THAT IS USED IN SUCH A MANNER. IF THE CUSTOMER OR CUSTOMER'S CUSTOMER USES OR PERMITS THE USE OF CIRRUS PRODUCTS IN CRITICAL APPLICATIONS, CUSTOMER AGREES, BY SUCH USE, TO FULLY INDEMNIFY CIRRUS, ITS OFFICERS, DIRECTORS, EMPLOYEES, DISTRIBUTORS AND OTHER AGENTS FROM ANY AND ALL LIABILITY, INCLUDING ATTORNEYS' FEES AND COSTS, THAT MAY RESULT FROM OR ARISE IN CONNECTION WITH THESE USES.

Cirrus Logic, Cirrus, and the Cirrus Logic logo designs are trademarks of Cirrus Logic, Inc. All other brand and product names in this document may be trademarks or service marks of their respective owners.

I<sup>2</sup>C is a registered trademark of Philips Semiconductor.

SPI is a trademark of Motorola, Inc.

Direct Stream Digital is a registered trademark of Sony Kabushiki Kaisha TA Sony Corporation.

DSD is a trademark of Sony Kabushiki Kaisha TA Sony Corporation