

SKKT 72, SKKH 72, SKKT 72B



SEMIPACK® 1

Thyristor / Diode Modules

SKKT 72
SKKH 72
SKKT 72B

Features

- Heat transfer through aluminium oxide ceramic isolated metal baseplate
- Hard soldered joints for high reliability
- UL recognized, file no. E 63 532

Typical Applications*

- DC motor control (e. g. for machine tools)
- AC motor soft starters
- Temperature control (e. g. for ovens, chemical processes)
- Professional light dimming (studios, theaters)

1) See the assembly instructions

V_{RSM} V	V_{RRM}, V_{DRM} V	$I_{TRMS} = 125 \text{ A}$ (maximum value for continuous operation) $I_{TAV} = 70 \text{ A}$ (sin. 180; $T_c = 85 \text{ °C}$)		
		SKKT 72/08E	SKKT 72B08E	SKKH 72/08E
900	800	SKKT 72/08E	SKKT 72B08E	SKKH 72/08E
1300	1200	SKKT 72/12E	SKKT 72B12E	SKKH 72/12E
1500	1400	SKKT 72/14E	SKKT 72B14E	SKKH 72/14E
1700	1600	SKKT 72/16E	SKKT 72B16E	SKKH 72/16E
1900	1800	SKKT 72/18E	SKKT 72B18E	SKKH 72/18E

Symbol	Conditions	Values	Units
I_{TAV}	sin. 180; $T_c = 85 \text{ (100) °C}$;	70 (50)	A
I_D	P3/180; $T_a = 45 \text{ °C}$; B2 / B6	62 / 75	A
	P3/180F; $T_a = 35 \text{ °C}$; B2 / B6	115 / 145	A
I_{RMS}	P3/180F; $T_a = 35 \text{ °C}$; W1 / W3	155 / 3 * 115	A
I_{TSM}	$T_{vj} = 25 \text{ °C}$; 10 ms	1600	A
	$T_{vj} = 125 \text{ °C}$; 10 ms	1450	A
i^2t	$T_{vj} = 25 \text{ °C}$; 8,3 ... 10 ms	13000	A ² s
	$T_{vj} = 125 \text{ °C}$; 8,3 ... 10 ms	10500	A ² s
V_T	$T_{vj} = 25 \text{ °C}$; $I_T = 300 \text{ A}$	max. 1,9	V
$V_{T(TO)}$	$T_{vj} = 125 \text{ °C}$	max. 0,9	V
r_T	$T_{vj} = 125 \text{ °C}$	max. 3,5	mΩ
I_{DD}, I_{RD}	$T_{vj} = 125 \text{ °C}$; $V_{RD} = V_{RRM}$; $V_{DD} = V_{DRM}$	max. 20	mA
t_{gd}	$T_{vj} = 25 \text{ °C}$; $I_G = 1 \text{ A}$; $di_G/dt = 1 \text{ A}/\mu\text{s}$	1	μs
t_{gr}	$V_D = 0,67 * V_{DRM}$	1	μs
$(di/dt)_{cr}$	$T_{vj} = 125 \text{ °C}$	max. 150	A/μs
$(dv/dt)_{cr}$	$T_{vj} = 125 \text{ °C}$	max. 1000	V/μs
t_q	$T_{vj} = 125 \text{ °C}$	80	μs
I_H	$T_{vj} = 25 \text{ °C}$; typ. / max.	150 / 250	mA
I_L	$T_{vj} = 25 \text{ °C}$; $R_G = 33 \text{ Ω}$; typ. / max.	300 / 600	mA
V_{GT}	$T_{vj} = 25 \text{ °C}$; d.c.	min. 3	V
I_{GT}	$T_{vj} = 25 \text{ °C}$; d.c.	min. 150	mA
V_{GD}	$T_{vj} = 125 \text{ °C}$; d.c.	max. 0,25	V
I_{GD}	$T_{vj} = 125 \text{ °C}$; d.c.	max. 6	mA
$R_{th(j-c)}$	cont.; per thyristor / per module	0,35 / 0,18	K/W
$R_{th(j-c)}$	sin. 180; per thyristor / per module	0,37 / 0,19	K/W
$R_{th(j-c)}$	rec. 120; per thyristor / per module	0,39 / 0,2	K/W
$R_{th(c-s)}$	per thyristor / per module	0,2 / 0,1	K/W
T_{vj}		- 40 ... + 125	°C
T_{stg}		- 40 ... + 125	°C
V_{isol}	a. c. 50 Hz; r.m.s.; 1 s / 1 min.	3600 / 3000	V~
M_s	to heatsink	5 ± 15 % ¹⁾	Nm
M_t	to terminals	3 ± 15 %	Nm
a		5 * 9,81	m/s ²
m	approx.	95	g
Case	SKKT	A 46	
	SKKT ...B	A 48	
	SKKH	A 47	

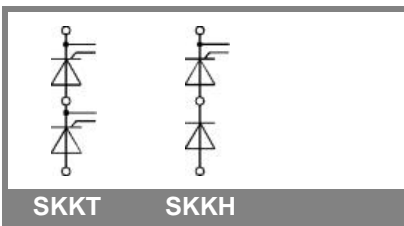

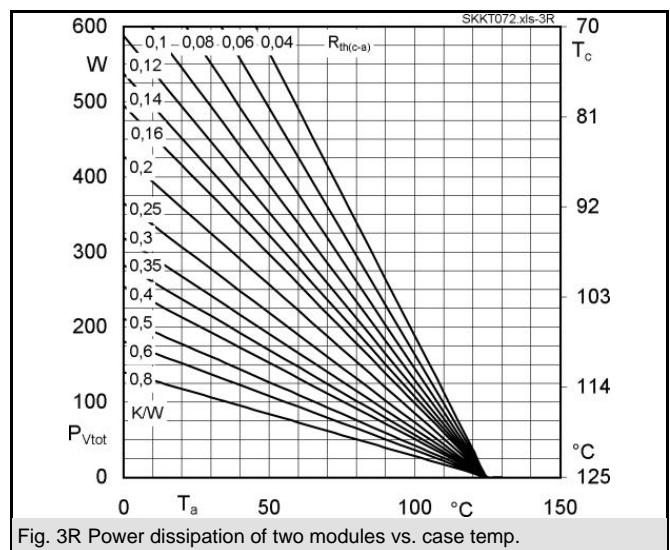
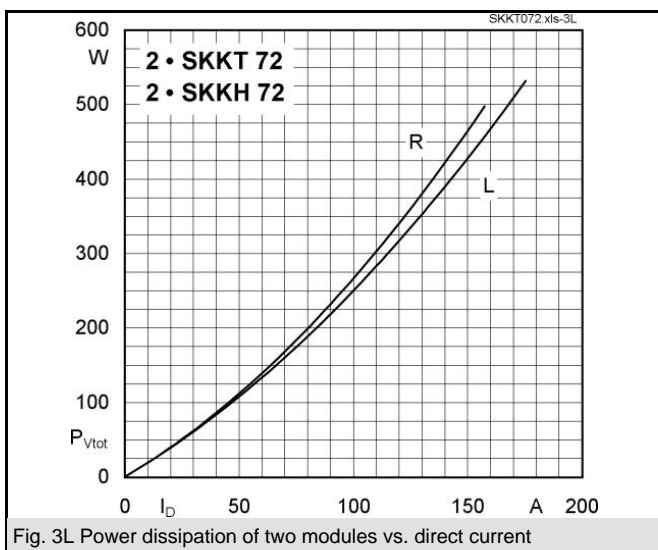
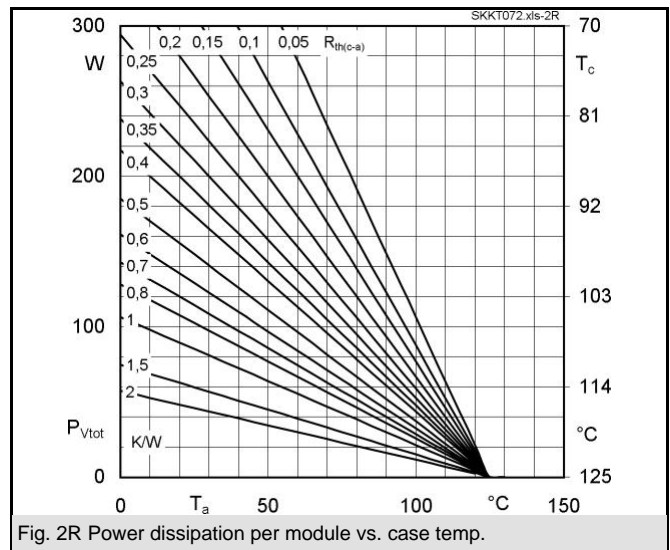
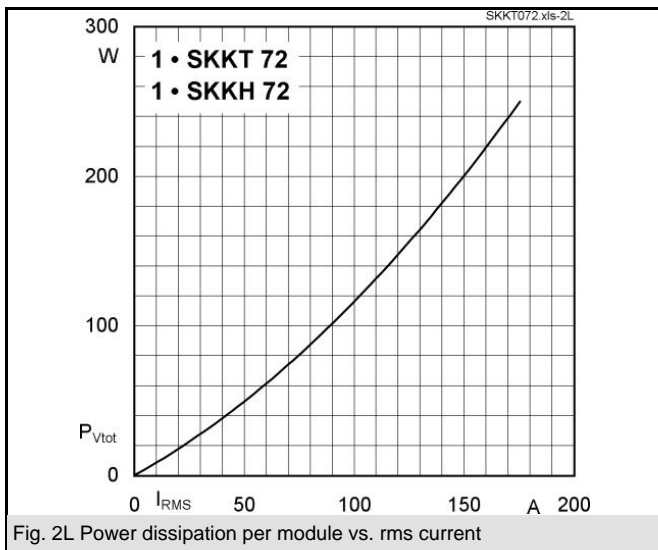
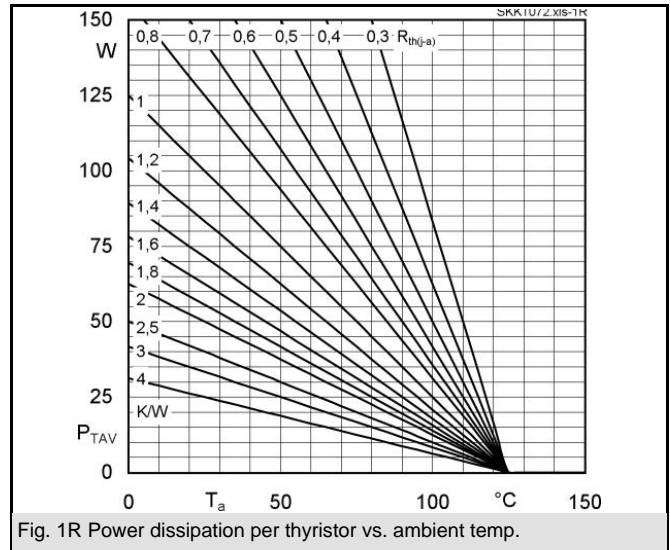
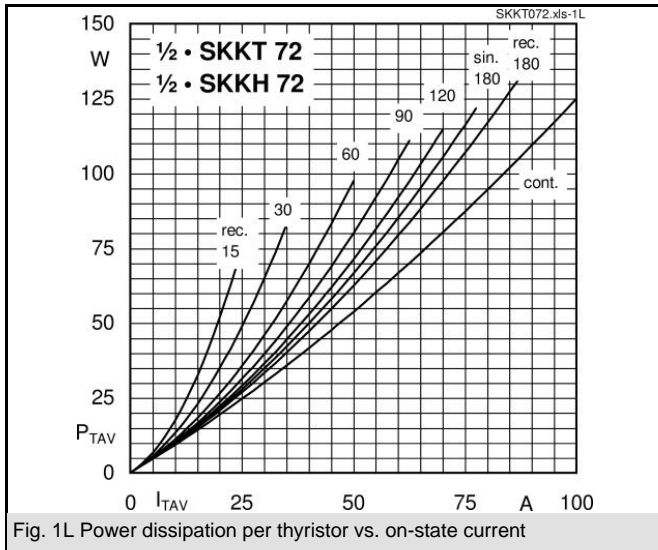

SKKT 72, SKKH 72, SKKT 72B

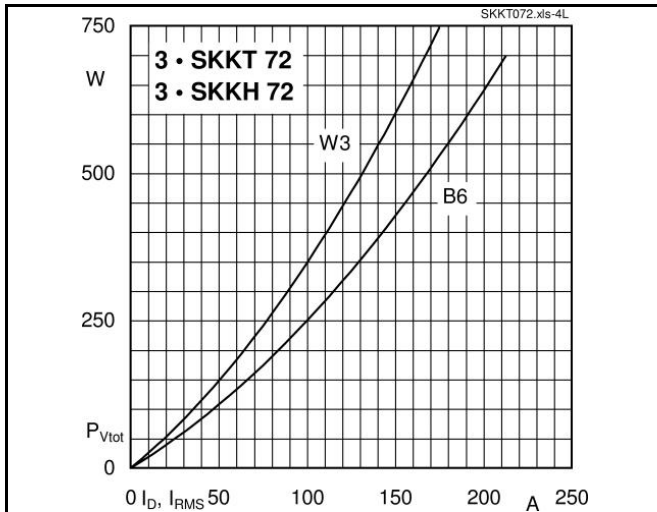

Fig. 4L Power dissipation of three modules vs. direct and rms current

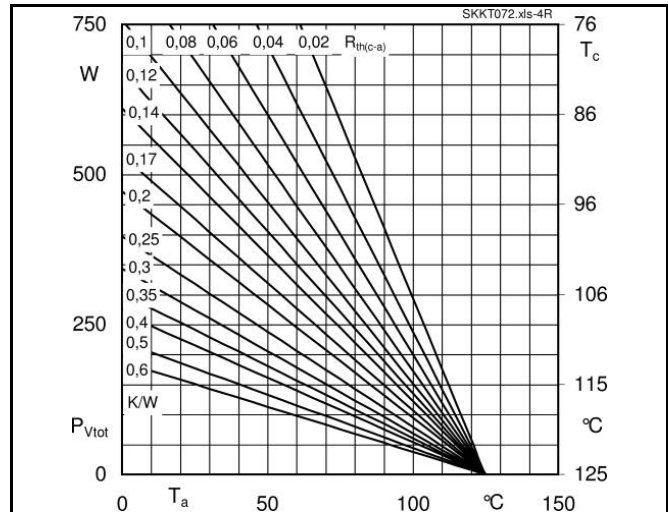

Fig. 4R Power dissipation of three modules vs. case temp.

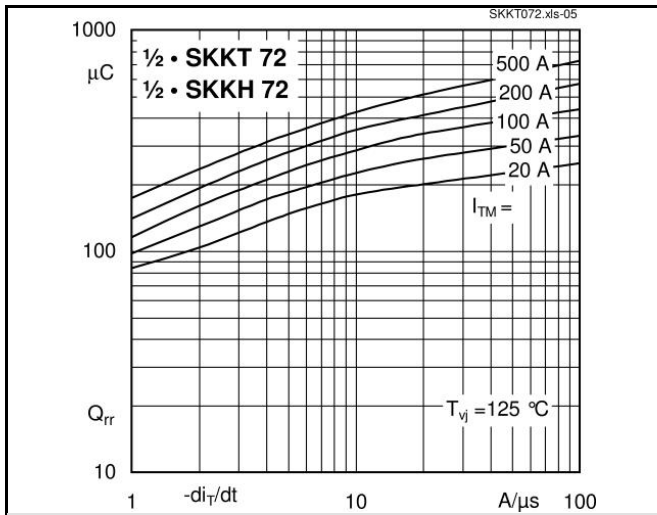

Fig. 5 Recovered charge vs. current decrease

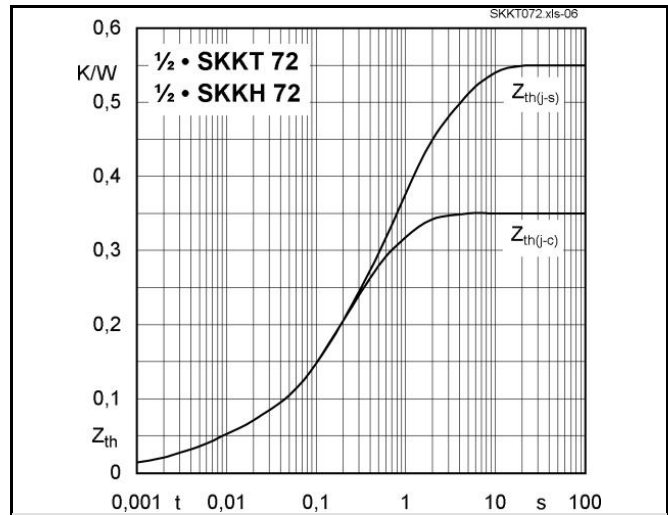

Fig. 6 Transient thermal impedance vs. time

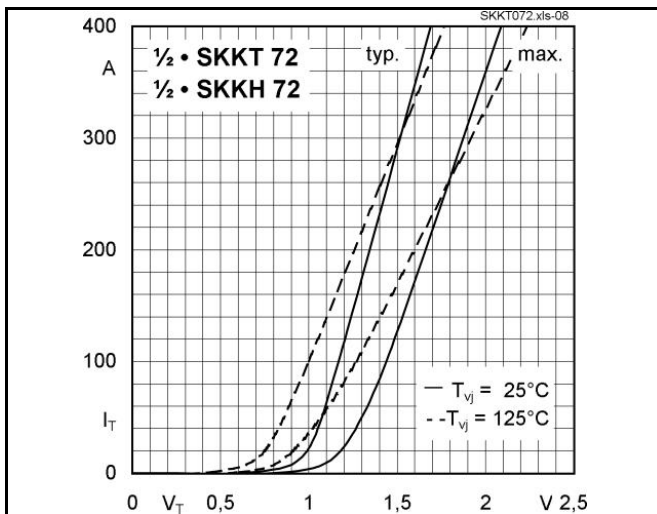

Fig. 7 On-state characteristics

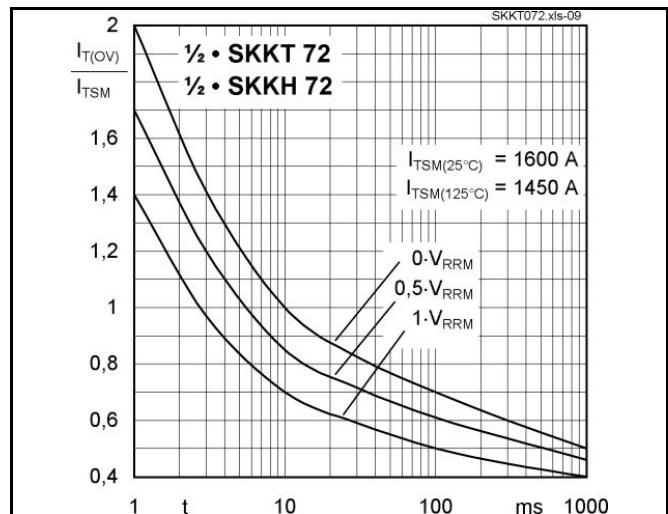
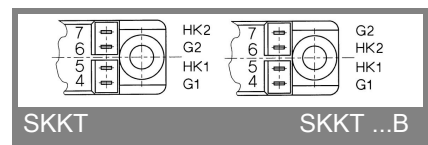
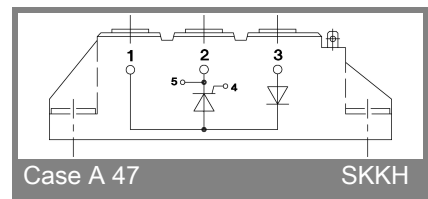
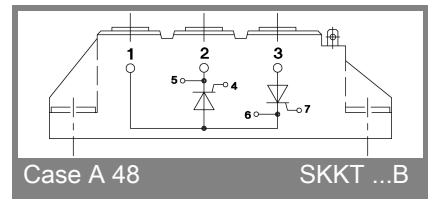
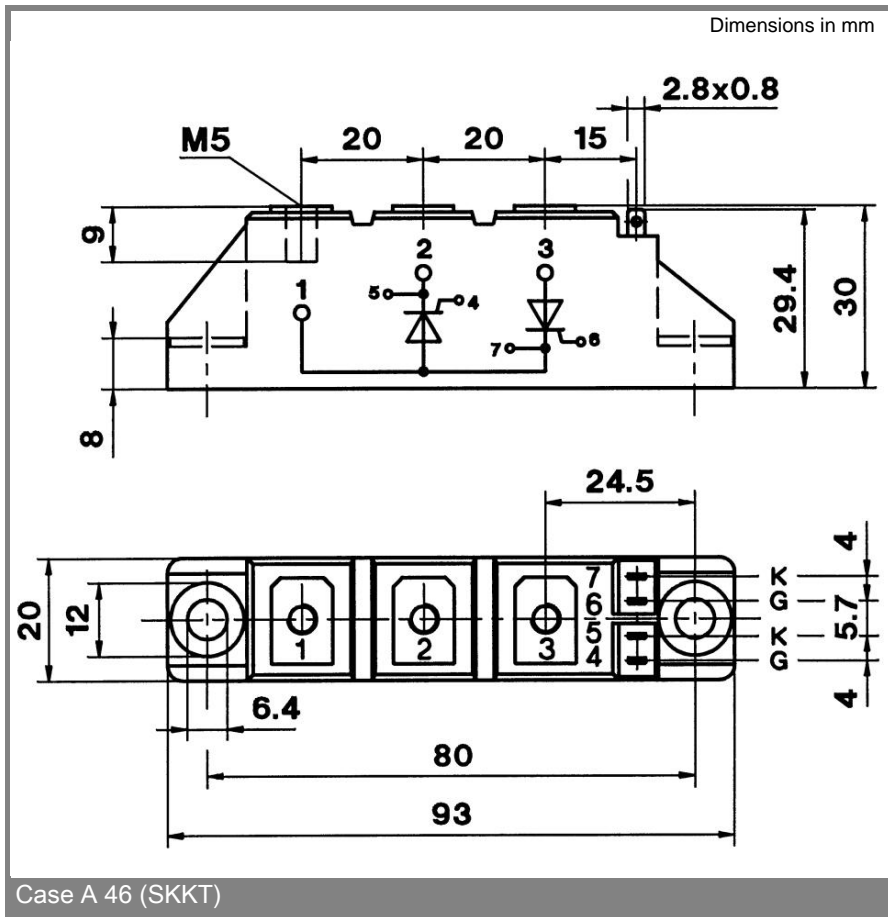
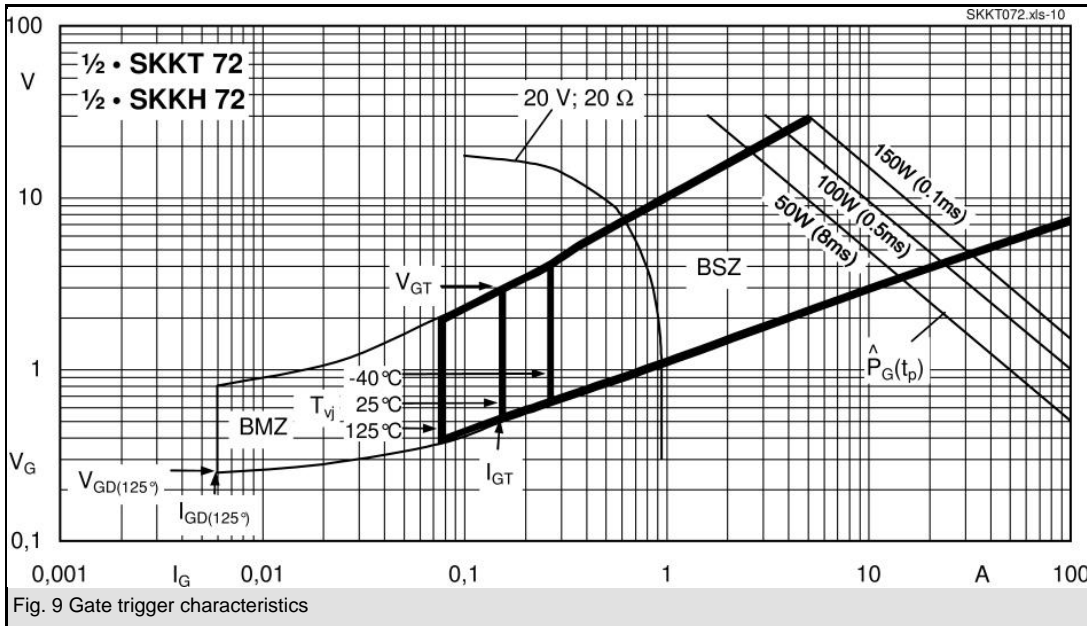

Fig. 8 Surge overload current vs. time



* The specifications of our components may not be considered as an assurance of component characteristics. Components have to be tested for the respective application. Adjustments may be necessary. The use of SEMIKRON products in life support appliances and systems is subject to prior specification and written approval by SEMIKRON. We therefore strongly recommend prior consultation of our personal.