

MITSUBISHI FAST RECOVERY DIODE MODULES

RM200HA-20F,-24F

HIGH SPEED SWITCHING USE
INSULATED TYPE

RM200HA-20F,-24F



- **Idc** DC current **200A**
- **VRRM** Repetitive peak reverse voltage
..... **1000/1200V**
- **trr** Reverse recovery time **0.8μs**
- **Insulated Type**
- **UL Recognized**

Yellow Card No. E80276 (N)
File No. E80271

APPLICATION

Free wheel use, Welders

OUTLINE DRAWING & CIRCUIT DIAGRAM

Dimensions in mm

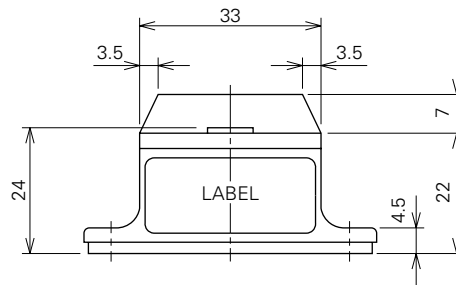
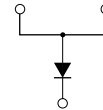
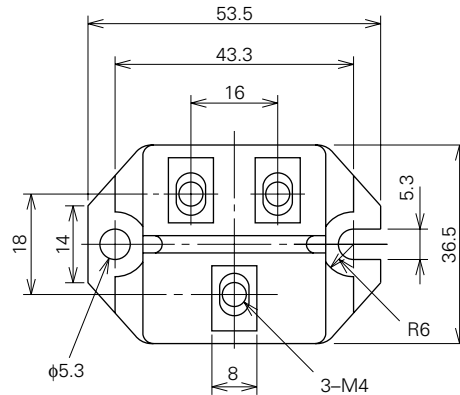

Feb.1999



<http://store.iic.cc/>

RM200HA-20F,-24F

HIGH SPEED SWITCHING USE
INSULATED TYPE

ABSOLUTE MAXIMUM RATINGS (T_j=25°C)

Symbol	Parameter	Voltage class		Unit
		20	24	
V _{RRM}	Repetitive peak reverse voltage	1000	1200	V
V _{DRM}	Non-repetitive peak reverse voltage	1100	1350	V
V _{R (DC)}	Reverse DC voltage	800	960	V

Symbol	Parameter	Conditions	Ratings	Unit
I _{DC}	DC output current	Resistive load, T _c =75°C	200	A
I _{FSM}	Surge (non-repetitive) forward current	One half cycle at 60Hz, peak value	4000	A
I ² _t	I ² _t for fusing	Value for one cycle of surge current	6.7 × 10 ⁴	A ² s
T _j	Junction temperature		-40~150	°C
T _{stg}	Storage temperature		-40~125	°C
V _{iso}	Isolation voltage	Charged part to case	2500	V
—	Mounting torque	Main terminal screw M4	0.98~1.47	N·m
			10~15	kg·cm
		Mounting screw M5	1.47~1.96	N·m
			15~20	kg·cm
—	Weight	Typical value	90	g

ELECTRICAL CHARACTERISTICS

Symbol	Parameter	Test conditions	Limits			Unit
			Min.	Typ.	Max.	
I _{RRM}	Repetitive reverse current	T _j =150°C, V _{RRM} applied	—	—	40	mA
V _{FM}	Forward voltage	T _j =25°C, I _{FM} =200A, instantaneous meas.	—	—	1.5	V
t _{rr}	Reverse recovery time	I _{FM} =200A, di/dt=-400A/μs, V _R =600V, T _j =150°C	—	—	0.8	μs
Q _{rr}	Reverse recovery charge		—	—	130	μC
R _{th (j-c)}	Thermal resistance	Junction to case	—	—	0.25	°C/W
R _{th (c-f)}	Contact thermal resistance	Case to fin, conductive grease applied	—	—	0.15	°C/W

RM200HA-20F,-24F

HIGH SPEED SWITCHING USE
INSULATED TYPE

PERFORMANCE CURVE

MAXIMUM FORWARD CHARACTERISTIC

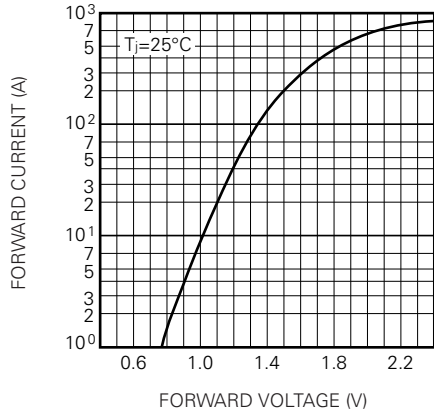

MAXIMUM TRANSIENT THERMAL IMPEDANCE (JUNCTION TO CASE)

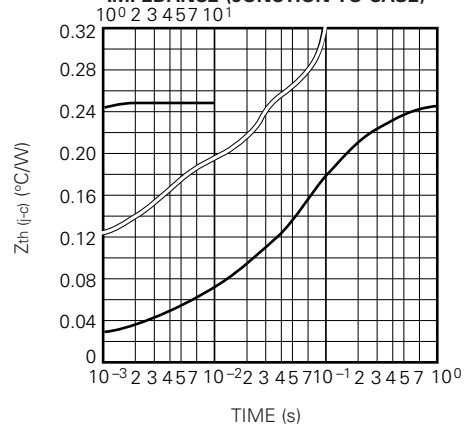

RATED SURGE (NON-REPETITIVE) FORWARD CURRENT

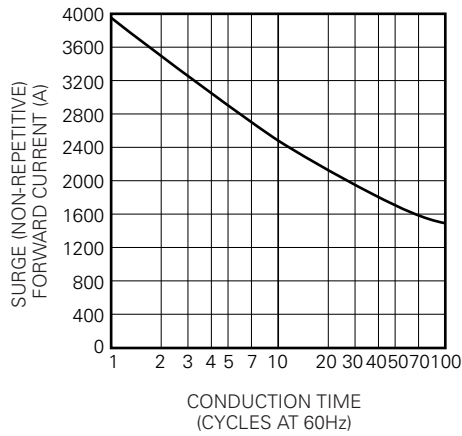

REVERSE RECOVERY CHARACTERISTICS VS. FORWARD CURRENT (TYPICAL)

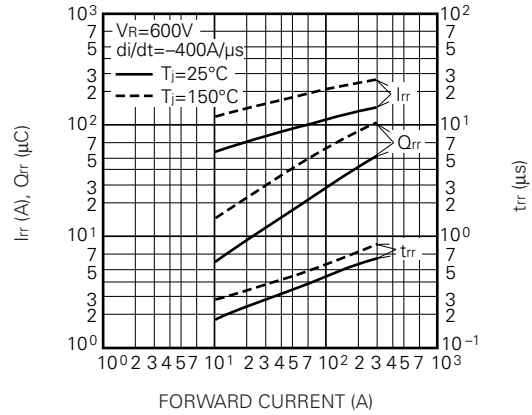

REVERSE RECOVERY CHARACTERISTICS VS. -di/dt (TYPICAL)

