

TOSHIBA INTEGRATED IGBT MODULE SILICON N CHANNEL IGBT

MIG30J906H, MIG30J906HA

HIGH POWER SWITCHING APPLICATIONS

MOTOR CONTROL APPLICATIONS

- Integrates Inverter, Converter and Brake Power Circuits and Thermistor in One Package.
- Output (Inverter Stage) : 3 ϕ 30A/600V IGBT
- Input (Converter Stage) : 3 ϕ 30A/800V Silicon Rectifier
- The Electrodes are Isolated from Case.
- Outline
 - MIG30J906H : 2-108E3A
 - MIG30J906HA : 2-108E4A
- Weight : 190g

EQUIVALENT CIRCUIT

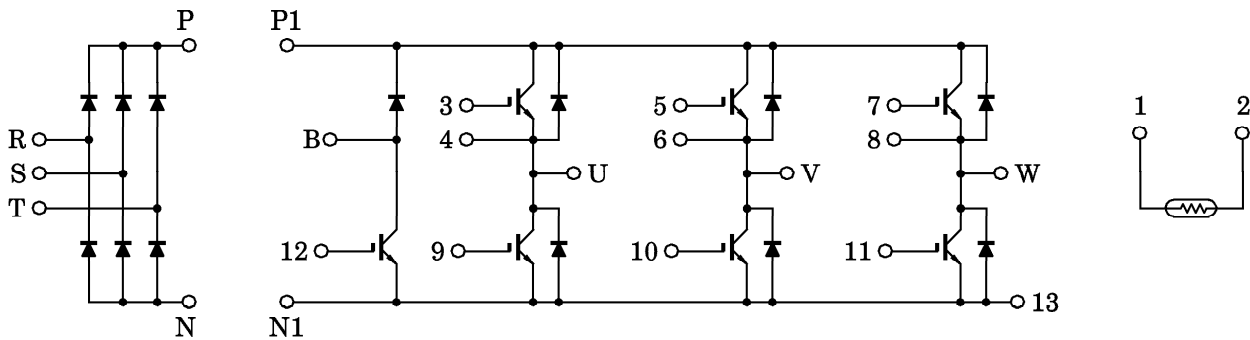

961001EAA2

● TOSHIBA is continually working to improve the quality and the reliability of its products. Nevertheless, semiconductor devices in general can malfunction or fail due to their inherent electrical sensitivity and vulnerability to physical stress. It is the responsibility of the buyer, when utilizing TOSHIBA products, to observe standards of safety, and to avoid situations in which a malfunction or failure of a TOSHIBA product could cause loss of human life, bodily injury or damage to property. In developing your designs, please ensure that TOSHIBA products are used within specified operating ranges as set forth in the most recent products specifications. Also, please keep in mind the precautions and conditions set forth in the TOSHIBA Semiconductor Reliability Handbook.

● The information contained herein is presented only as a guide for the applications of our products. No responsibility is assumed by TOSHIBA CORPORATION for any infringements of intellectual property or other rights of the third parties which may result from its use. No license is granted by implication or otherwise under any intellectual property or other rights of TOSHIBA CORPORATION or others.

● The information contained herein is subject to change without notice.

Package Dimension

Unit : mm

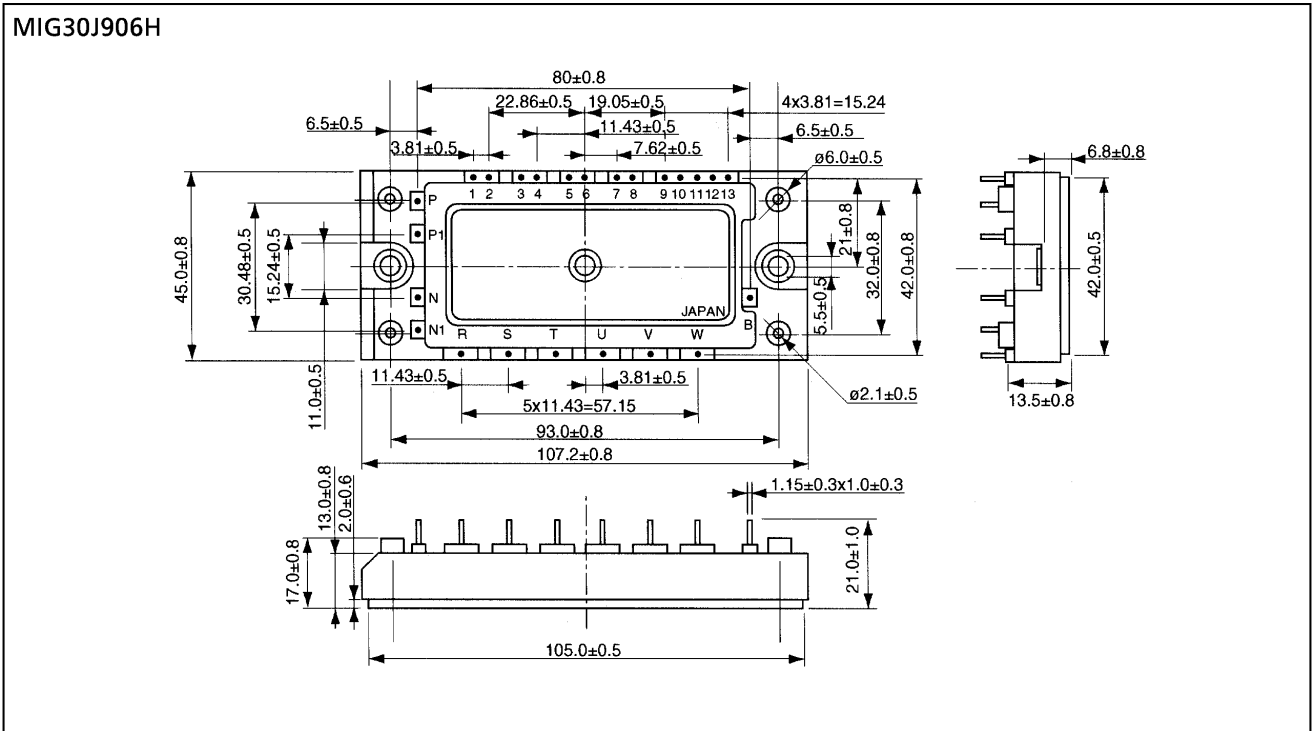

2-108E3A

Unit : mm

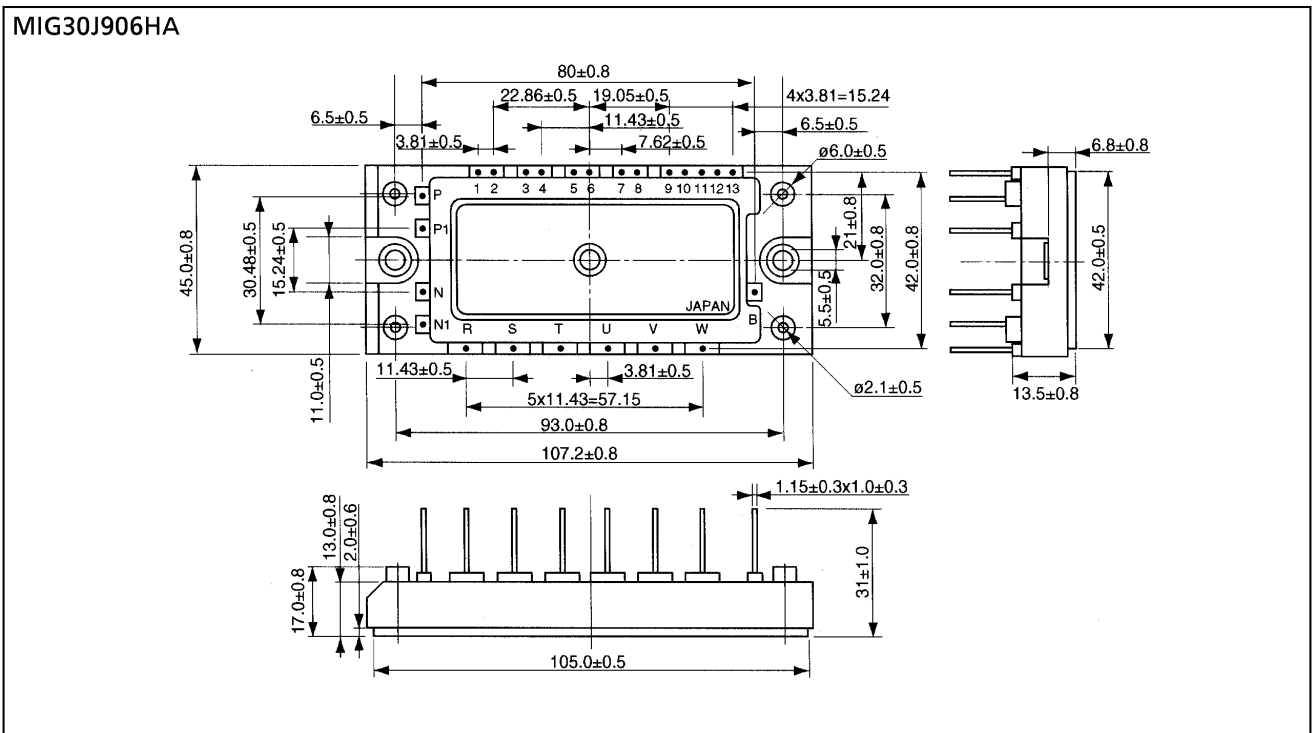

2-108E4A

MAXIMUM RATINGS (Ta = 25°C)

STAGE		CHARACTERISTIC		SYMBOL	RATING	UNIT	
Inverter	Collector-Emitter Voltage			V _{CES}	600	V	
	Gate-Emitter Voltage			V _{GES}	± 20	V	
	Collector Current	DC	I _C	35 / 30	A	(25°C / 40°C)	
		1ms	I _{CP}	70 / 60	A		
	Forward Current	DC	I _F	30	A	(25°C / 40°C)	
		1ms	I _{FM}	60	A		
Collector Power Dissipation (T _c = 25°C)			P _C	125	W		
Converter	Repetitive Peak Reverse Voltage			V _R RM	800	V	
	Average Output Rectified Current			I _O	30	A	
	Peak One Cycle Surge Forward Current (50Hz, Non-Repetitive)			I _F SM	400	A	
Brake	IGBT	Collector-Emitter Voltage		V _{CES}	600	V	
		Gate-Emitter Voltage		V _{GES}	± 20	V	
		Collector Current	DC	I _C	35 / 30	A	(25°C / 40°C)
			1ms	I _{CP}	70 / 60	A	
	Collector Power Dissipation (T _c = 25°C)			P _C	125	W	
	FWD	Reverse Voltage			V _R	600	V
		Forward Current	DC	I _F	30	A	
			1ms	I _{FM}	60	A	
Module	Junction Temperature			T _j	150	°C	
	Storage Temperature Range			T _{stg}	-40~125	°C	
	Isolation Voltage			V _{Isol}	2500 (AC 1 minute)	V	
	Screw Torque			—	6	N·m	

ELECTRICAL CHARACTERISTICS (Ta = 25°C)

a. Inverter stage

CHARACTERISTIC		SYMBOL	TEST CONDITION	MIN.	TYP.	MAX.	UNIT
Gate Leakage Current		I_{GES}	$V_{GE} = \pm 20V, V_{CE} = 0$	—	—	±500	nA
Collector Cut-Off Current		I_{CES}	$V_{CE} = 600V, V_{GE} = 0$	—	—	1.0	mA
Gate-Emitter Cut-Off Voltage		$V_{GE} (off)$	$I_C = 3mA, V_{CE} = 5V$	5.0	—	8.0	V
Collector-Emitter Saturation Voltage		$V_{CE} (sat)$	$I_C = 30A$	—	2.1	2.7	V
			$V_{GE} = 15V$				
Input Capacitance		C_{ies}	$V_{CE} = 10V, V_{GE} = 0, f = 1MHz$	—	—	—	pF
Switching Time	Rise Time	t_r	$V_{CC} = 300V$ $I_C = 30A$ $V_{GE} = \pm 15V$ $R_G = 43\Omega$ (Note 1)	—	0.10	0.20	μs
	Turn-On Time	t_{on}		—	0.25	0.50	
	Fall Time	t_f		—	0.15	0.30	
	Turn-Off Time	t_{off}		—	0.50	0.80	
Forward Voltage		V_F	$I_F = 30A, V_{GE} = 0$	—	2.0	2.8	V
Reverse Recovery Time		t_{rr}	$I_F = 30A, V_{GE} = -10V$ $di / dt = 100A / \mu s$	—	0.08	0.15	μs
Thermal Resistance		$R_{th(j-c)}$	Transistor	—	—	1.0	$^\circ C / W$
			Diode	—	—	2.6	

b. Converter stage

CHARACTERISTIC		SYMBOL	TEST CONDITION	MIN.	TYP.	MAX.	UNIT
Repetitive Peak Reverse Current		I_{RRM}	$V_{RRM} = 800V$	—	—	50	μA
Peak Forward Voltage		V_{FM}	$I_{FM} = 30A$	—	1.05	1.20	V
Peak One Cycle Surge Forward Current		I_{FSM}	50Hz sine-half-wave	400	—	—	A
Thermal Resistance		$R_{th(j-c)}$	—	—	—	1.56	$^\circ C / W$

c. Brake stage

CHARACTERISTIC		SYMBOL	TEST CONDITION	MIN.	TYP.	MAX.	UNIT
Gate Leakage Current		I_{GES}	$V_{GE} = \pm 20V, V_{CE} = 0$	—	—	± 500	nA
Collector Cut-Off Current		I_{CES}	$V_{CE} = 600V, V_{GE} = 0$	—	—	1.0	mA
Reverse Current		I_R	$V_R = 600V$	—	—	1.0	mA
Gate-Emitter Cut-Off Voltage		$V_{GE} (off)$	$I_C = 3mA, V_{CE} = 5V$	5.0	—	8.0	V
Collector-Emitter Saturation Voltage		$V_{CE} (sat)$	$I_C = 30A$	—	2.1	2.7	V
			$V_{GE} = 15V$	—	2.2	2.8	
Input Capacitance		C_{ies}	$V_{CE} = 10V, V_{GE} = 0, f = 1MHz$	—	—	—	pF
Switching Time	Rise Time	t_r	$V_{CC} = 300V$ $I_C = 30A$ $V_{GE} = \pm 15V$ $R_G = 43\Omega$ (Note 1)	—	0.10	0.20	μs
	Turn-On Time	t_{on}		—	0.25	0.50	
	Fall Time	t_f		—	0.15	0.30	
	Turn-Off Time	t_{off}		—	0.50	0.80	
Forward Voltage		V_F	$I_F = 30A, V_{GE} = 0$	—	2.0	2.8	V
Thermal Resistance		$R_{th(j-c)}$	Transistor	—	—	1.0	$^{\circ}C/W$
			Diode	—	—	2.6	

d. Thermistor

CHARACTERISTIC	SYMBOL	TEST CONDITION	MIN.	TYP.	MAX.	UNIT
Zero-power Resistance	R_{25}	$I_{TM} = 0.2mA, T_c = 25^{\circ}C$	17.31	20	23.14	k Ω
B Value	$B_{25/85}$	$T_c = 25^{\circ}C / T_c = 85^{\circ}C$	—	3760	—	K

(Note 1) Switching Time Test Circuit & Timing Chart

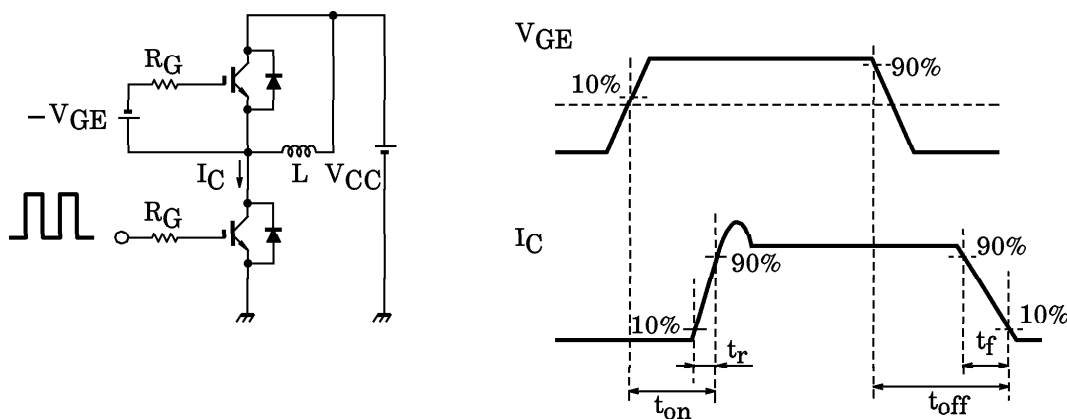

a. Inverter stage / c. Brake stage

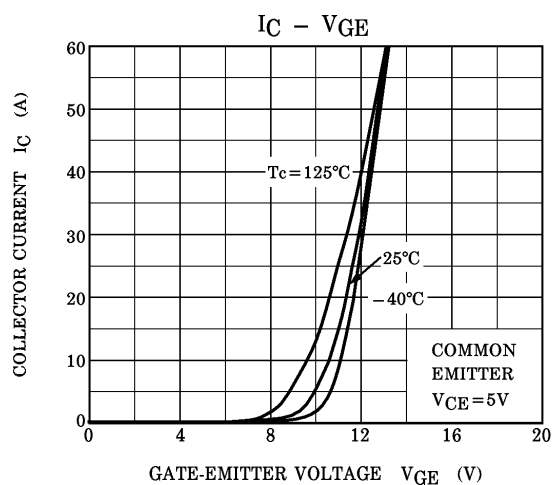
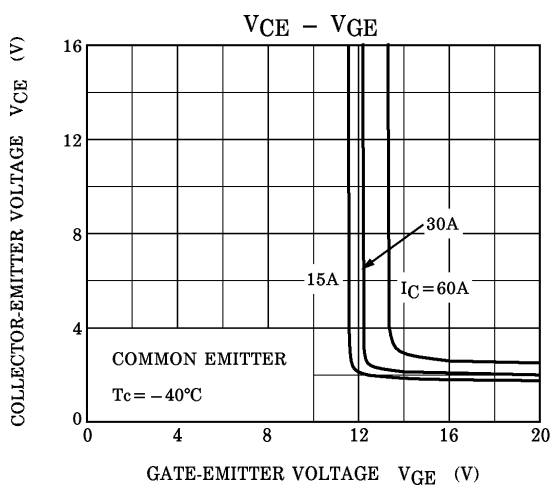
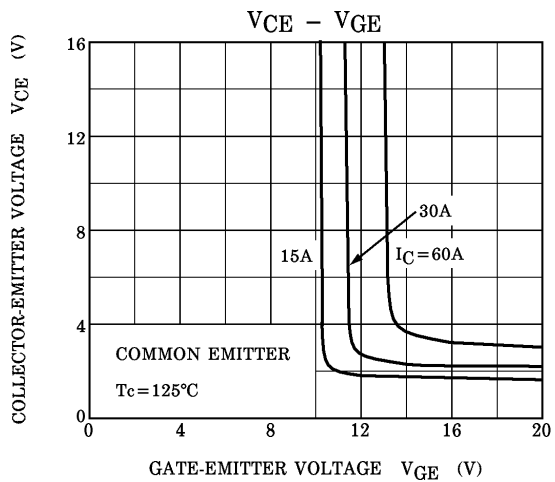
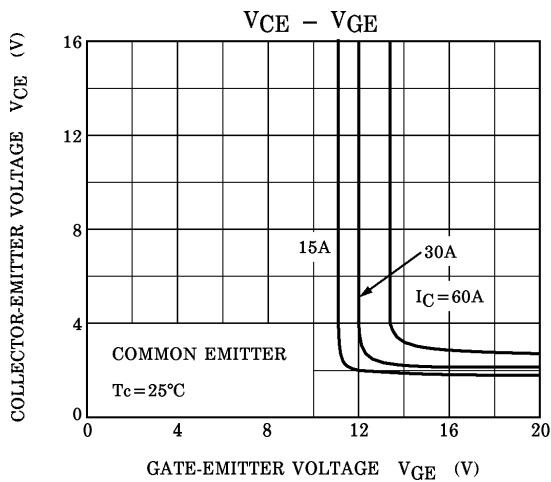
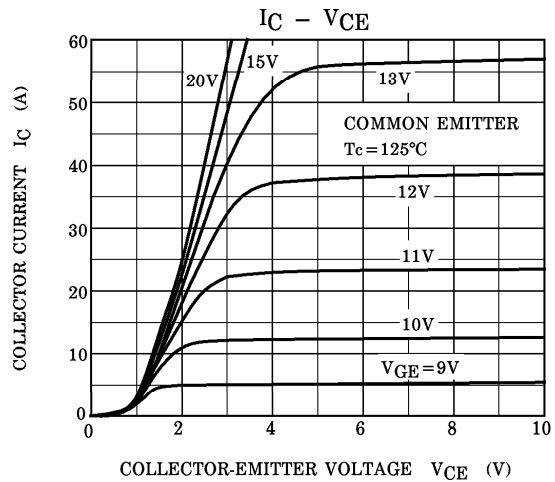
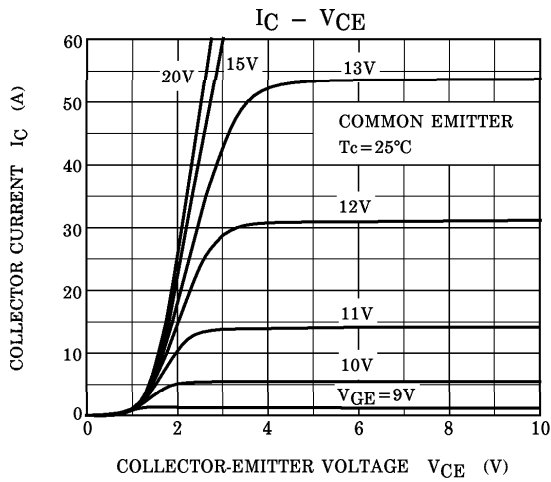

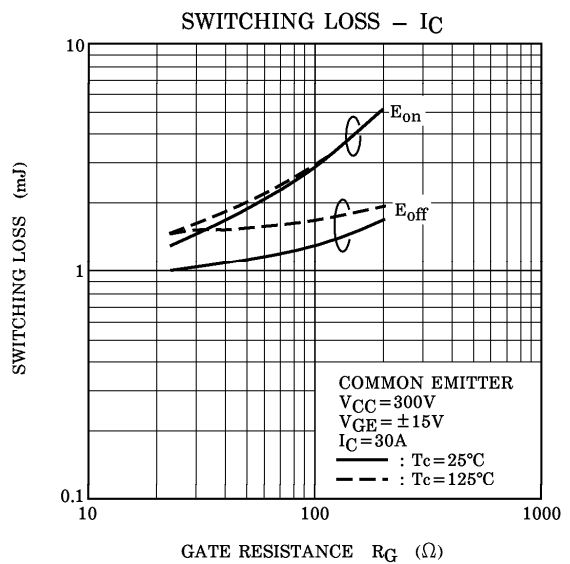
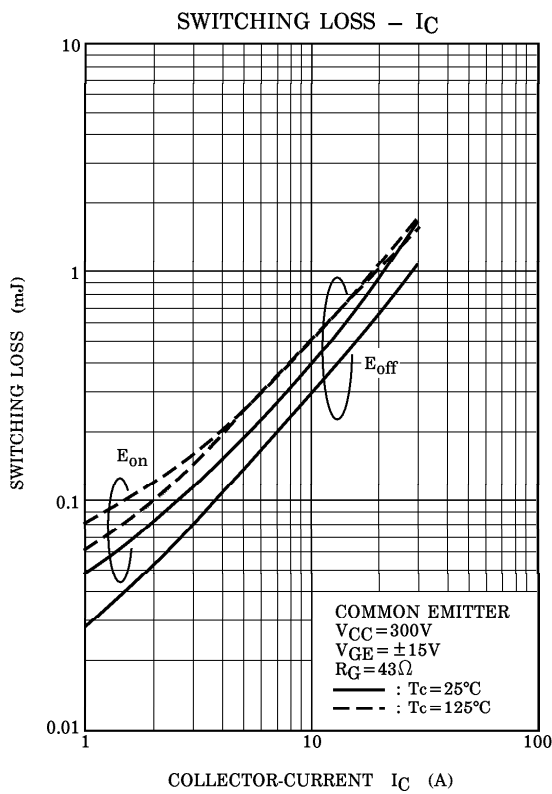
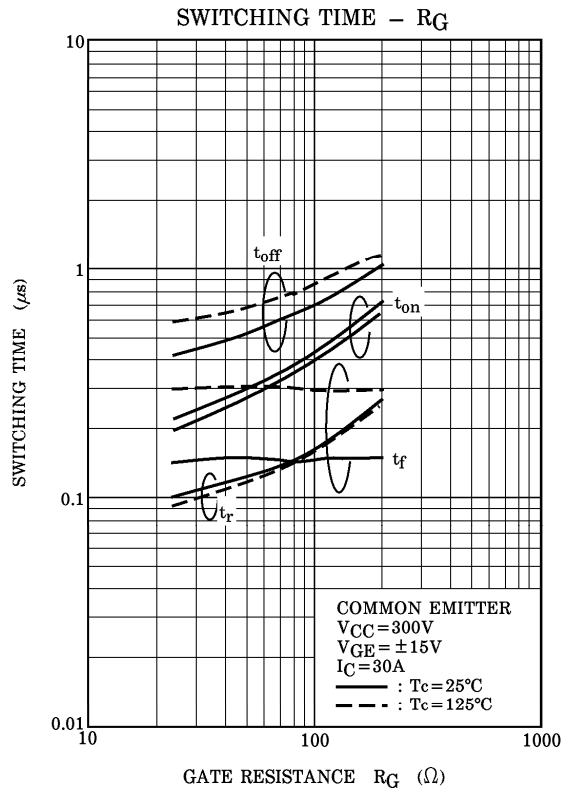
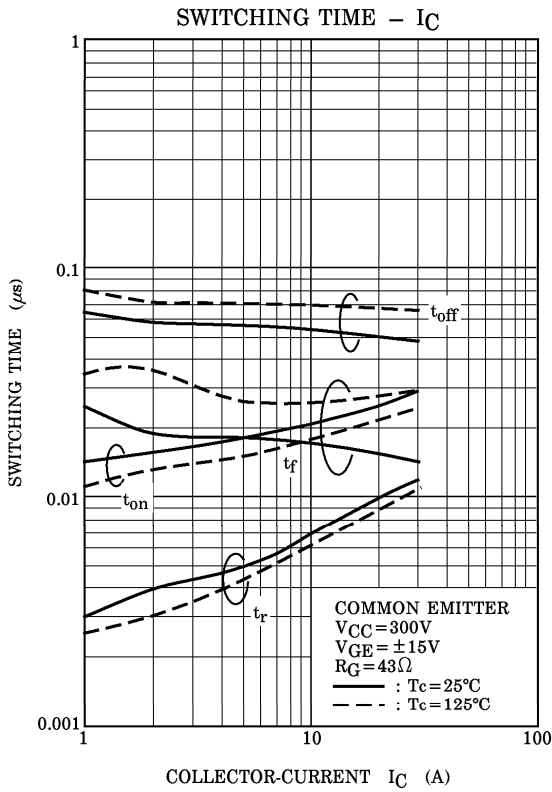

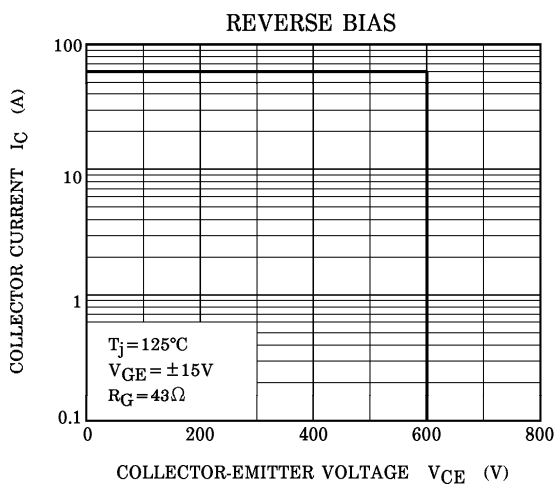
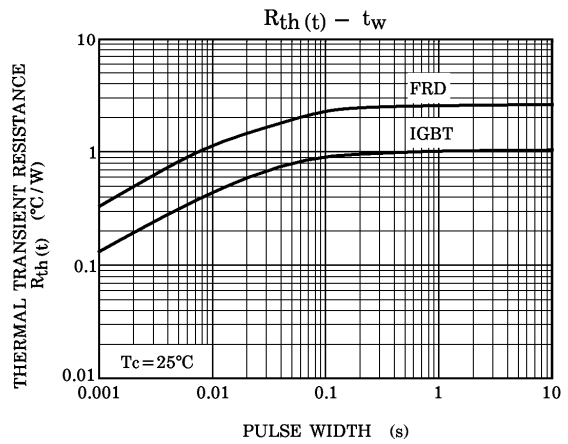
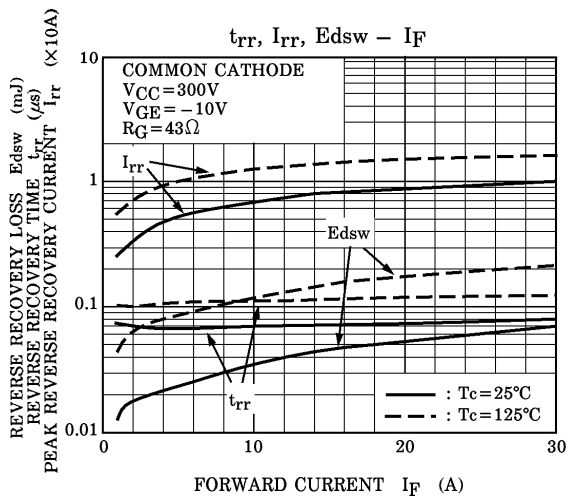
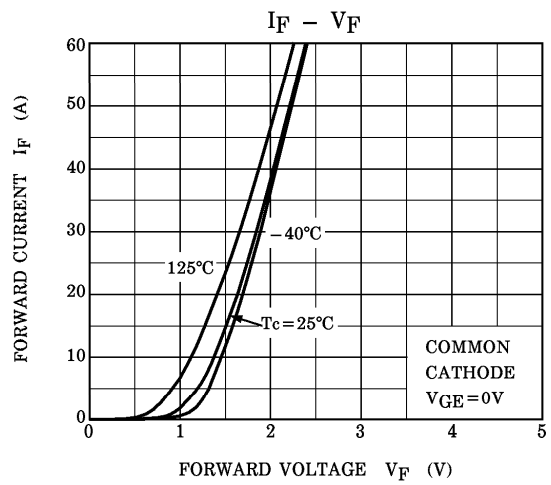
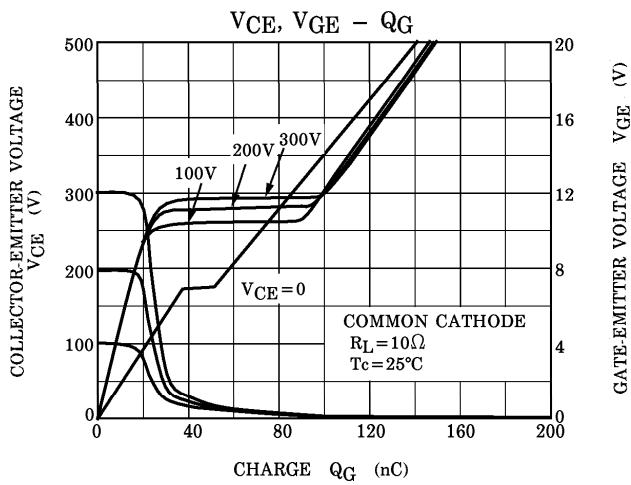

b. Converter stage

