

THYRISTOR/ DIODE and THYRISTOR/ THYRISTOR

ADD-A-pak™ GEN V Power Modules

Features

- High Voltage
- Industrial Standard Package
- Thick Al metal die and double stick bonding
- Thick copper baseplate
- UL E78996 approved
- 3500V_{RMS} isolating voltage

Benefits

- Up to 1600V
- Full compatible TO-240AA
- High Surge capability
- Easy Mounting on heatsink
- Al₂O₃ DBC insulator
- Heatsink grounded

27 A

Mechanical Description

The Generation V of Add-A-pak module combine the excellent thermal performance obtained by the usage of Direct Bonded Copper substrate with superior mechanical ruggedness, thanks to the insertion of a solid Copper baseplate at the bottom side of the device.

The Cu baseplate allow an easier mounting on the majority of heatsink with increased tolerance of surface roughness and improve thermal spread.

The Generation V of AAP module is manufactured without hard mold, eliminating in this way any possible direct stress on the leads.

The electrical terminals are secured against axial pull-out: they are fixed to the module housing via a click-stop feature already tested and proved as reliable on other IR modules.

Electrical Description

These modules are intended for general purpose high voltage applications such as high voltage regulated power supplies, lighting circuits, temperature and motor speed control circuits, UPS and battery charger.

Major Ratings and Characteristics

Parameters	IRK.26	Units
$I_{T(AV)}$ or $I_{F(AV)}$ @ 85°C	27	A
$I_{O(RMS)}$ (*)	60	A
I_{TSM} @ 50Hz	400	A
I_{FSM} @ 60Hz	420	A
i^2t @ 50Hz	800	A ² s
@ 60Hz	730	A ² s
$i^2\sqrt{t}$	8000	A ² √s
V_{RRM} range	400 to 1600	V
T_{STG}	-40 to 125	°C
T_J	-40 to 125	°C

(*) As AC switch.



IRK.26 Series

Bulletin I27130 rev. G 10/02

International
IR Rectifier

ELECTRICAL SPECIFICATIONS

Voltage Ratings

Type number	Voltage Code	V_{RRM} , maximum repetitive peak reverse voltage V	V_{RSM} , maximum non-repetitive peak reverse voltage V	V_{DRM} , max. repetitive peak off-state voltage, gate open circuit V	I_{RRM} I_{DRM} 125°C mA
IRK.26	04	400	500	400	15
	06	600	700	600	
	08	800	900	800	
	10	1000	1100	1000	
	12	1200	1300	1200	
	14	1400	1500	1400	
	16	1600	1700	1600	

On-state Conduction

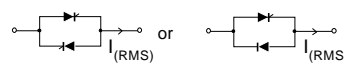
Parameters	IRK.26	Units	Conditions		
$I_{T(AV)}$ Max. average on-state current (Thyristors)	27	A	180° conduction, half sine wave, $T_C = 85^\circ\text{C}$		
$I_{F(AV)}$ Max. average forward current (Diodes)	27				
$I_{O(RMS)}$ Max. continuous RMS on-state current. As AC switch	60				
I_{TSM} Max. peak, one cycle or non-repetitive on-state I_{FSM} or forward current	400				Sinusoidal half wave, Initial $T_J = T_J \text{ max.}$
	420				
	335				
	350				
	470				
	490				
I^2t Max. I^2t for fusing	800	A ² s	Initial $T_J = T_J \text{ max.}$		
	730				
	560				
	510				
	1100				
	1000				
$I^2\sqrt{t}$ Max. $I^2\sqrt{t}$ for fusing (1)	8000	A ² √s	$t = 0.1$ to 10ms , no voltage reappl. $T_J = T_J \text{ max}$		
$V_{T(TO)}$ Max. value of threshold voltage (2)	0.92	V	Low level (3)	$T_J = T_J \text{ max}$	
	0.95		High level (4)		
r_t Max. value of on-state slope resistance (2)	12.11	mΩ	Low level (3)	$T_J = T_J \text{ max}$	
	11.82		High level (4)		
V_{TM} Max. peak on-state or V_{FM} forward voltage	1.95	V	$I_{TM} = \pi \times I_{T(AV)}$	$T_J = 25^\circ\text{C}$	
			$I_{FM} = \pi \times I_{F(AV)}$		
di/dt Max. non-repetitive rate of rise of turned on current	150	A/μs	$T_J = 25^\circ\text{C}$, from $0.67 V_{DRM}$, $I_{TM} = \pi \times I_{T(AV)}$, $I_g = 500\text{mA}$, $t_r < 0.5 \mu\text{s}$, $t_p > 6 \mu\text{s}$		
I_H Max. holding current	200	mA	$T_J = 25^\circ\text{C}$, anode supply = 6V, resistive load, gate open circuit		
I_L Max. latching current	400		$T_J = 25^\circ\text{C}$, anode supply = 6V, resistive load		

(1) I^2t for time $t_x = I^2t \times \sqrt{t_x}$

(2) Average power = $V_{T(TO)} \times I_{T(AV)} + r_t \times (I_{T(RMS)})^2$

(3) $16.7\% \times \pi \times I_{AV} < I < \pi \times I_{AV}$

(4) $I > \pi \times I_{AV}$

Triggering

Parameters	IRK.26	Units	Conditions	
P_{GM} Max. peak gate power	10	W		
$P_{G(AV)}$ Max. average gate power	2.5			
I_{GM} Max. peak gate current	2.5	A		
$-V_{GM}$ Max. peak negative gate voltage	10	V	Anode supply = 6V resistive load	
V_{GT} Max. gate voltage required to trigger	4.0			$T_J = -40^\circ\text{C}$
	2.5			$T_J = 25^\circ\text{C}$
	1.7	$T_J = 125^\circ\text{C}$		
I_{GT} Max. gate current required to trigger	270	mA	Anode supply = 6V resistive load	
	150			$T_J = -40^\circ\text{C}$
	80			$T_J = 25^\circ\text{C}$
V_{GD} Max. gate voltage that will not trigger	0.25	V	$T_J = 125^\circ\text{C}$, rated V_{DRM} applied	
I_{GD} Max. gate current that will not trigger	6	mA	$T_J = 125^\circ\text{C}$, rated V_{DRM} applied	

Blocking

Parameters	IRK.26	Units	Conditions
I_{RRM} Max. peak reverse and off-state leakage current at V_{RRM} , V_{DRM}	15	mA	$T_J = 125^\circ\text{C}$, gate open circuit
V_{INS} RMS isolation voltage	2500 (1 min) 3500 (1 sec)	V	50 Hz, circuit to base, all terminals shorted
dv/dt Max. critical rate of rise	500	V/ μs	$T_J = 125^\circ\text{C}$, linear to $0.67 V_{DRM}$

(5) Available with dv/dt = 1000V/ μs , to complete code add S90 i.e. IRKT26/16AS90.

Thermal and Mechanical Specifications

Parameters	IRK.26	Units	Conditions
T_J Junction operating temperature range	- 40 to 125	°C	
T_{stg} Storage temp. range	- 40 to 125		
R_{thJC} Max. internal thermal resistance, junction to case	0.31	K/W	Per module, DC operation
R_{thCS} Typical thermal resistance case to heatsink	0.1		Mounting surface flat, smooth and greased
T Mounting torque $\pm 10\%$ to heatsink busbar	5	Nm	A mounting compound is recommended and the torque should be rechecked after a period of 3 hours to allow for the spread of the compound
	3		
wt Approximate weight	110 (4)	gr (oz)	
Case style	TO-240AA		JEDEC

ΔR Conduction (per Junction)

(The following table shows the increment of thermal resistance R_{thJC} when devices operate at different conduction angles than DC)

Devices	Sine half wave conduction					Rect. wave conduction					Units
	180°	120°	90°	60°	30°	180°	120°	90°	60°	30°	
IRK.26	0.23	0.27	0.34	0.48	0.73	0.17	0.28	0.36	0.49	0.73	°C/W

IRK.26 Series

Bulletin I27130 rev. G 10/02

Ordering Information Table

Device Code	IRK	T	26	/	16	A	S90
	①	②	③		④	⑤	⑥

1	-	Module type	
2	-	Circuit configuration (See Circuit Configuration table below)	
3	-	Current code **	** Available with no auxiliary cathode. To specify change: 26 to 27
4	-	Voltage code (See Voltage Ratings table)	
5	-	A : Gen V	
6	-	dv/dt code: S90 = dv/dt 1000 V/μs No letter = dv/dt 500 V/μs	e.g. : IRKT27/16A etc.

IRK.27 types
With no auxiliary cathode

Outline Table

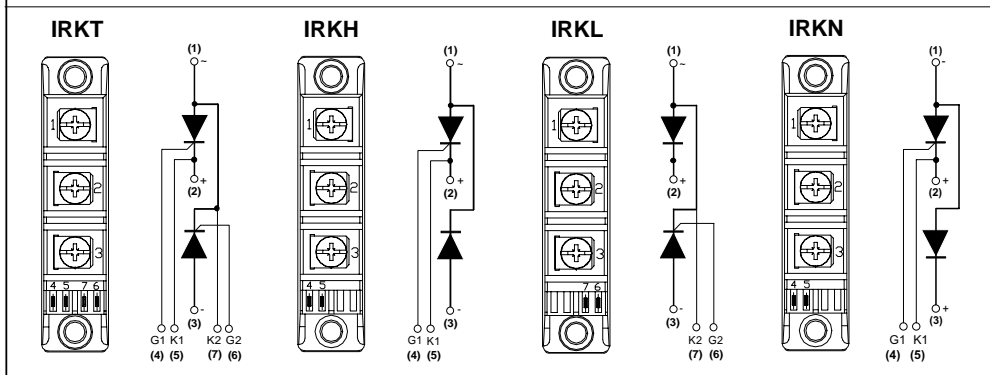
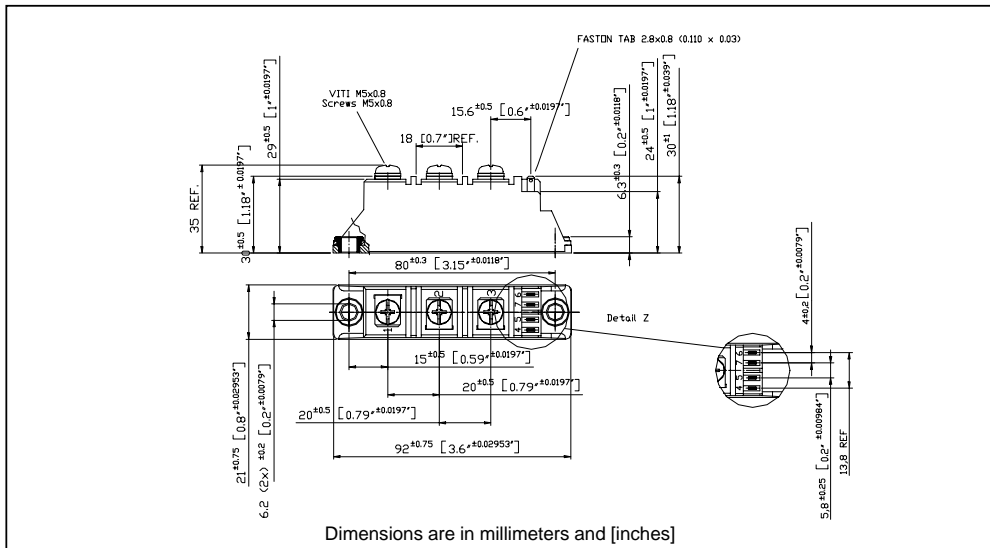

NOTE: To order the Optional Hardware see Bulletin I27900

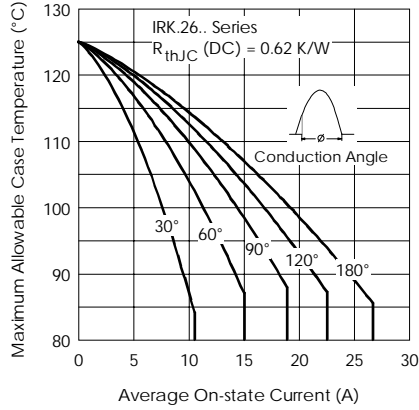

Fig. 1 - Current Ratings Characteristics

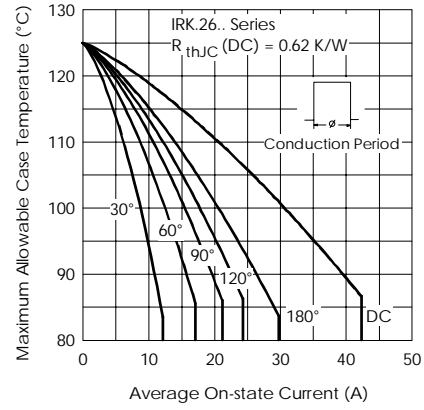

Fig. 2 - Current Ratings Characteristics

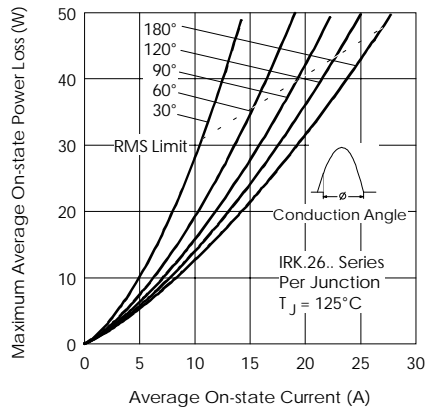

Fig. 3 - On-state Power Loss Characteristics

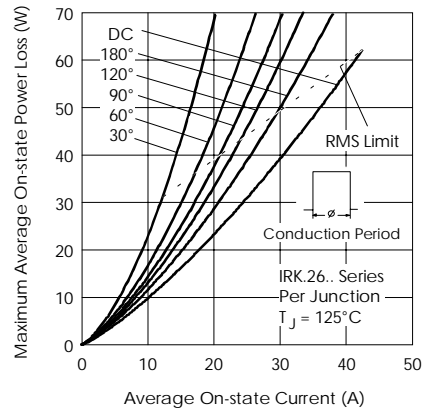

Fig. 4 - On-state Power Loss Characteristics

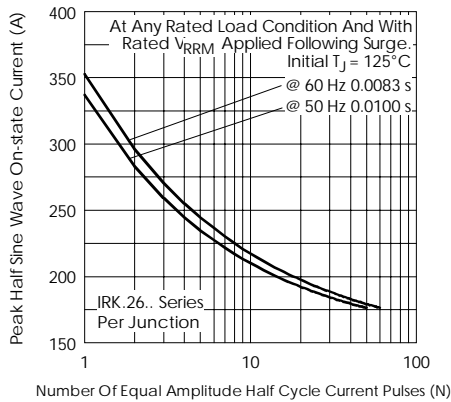

Fig. 5 - Maximum Non-Repetitive Surge Current

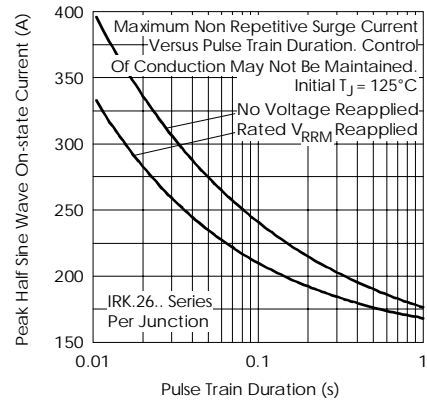

Fig. 6 - Maximum Non-Repetitive Surge Current

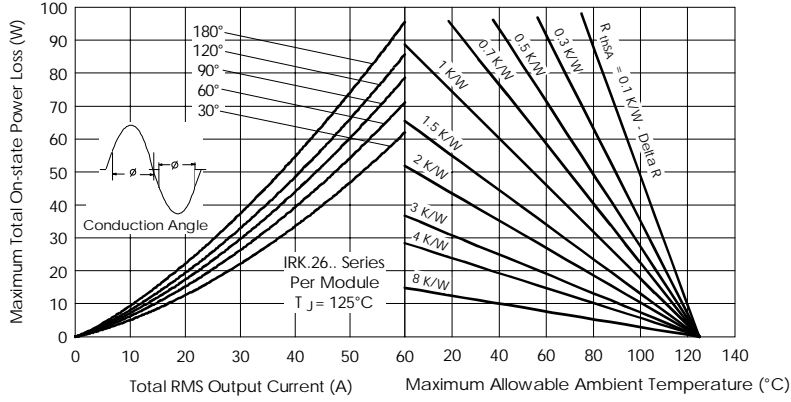

Fig. 7 - On-state Power Loss Characteristics

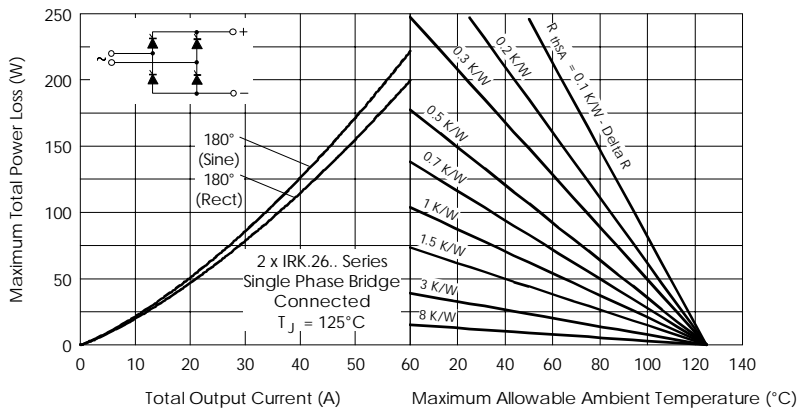

Fig. 8 - On-state Power Loss Characteristics

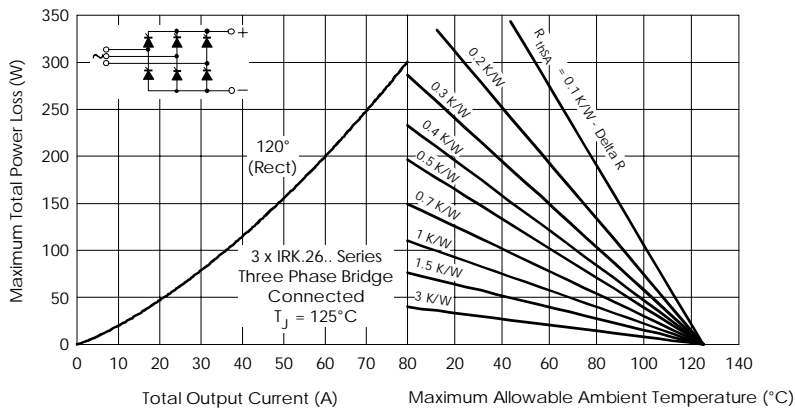

Fig. 9 - On-state Power Loss Characteristics

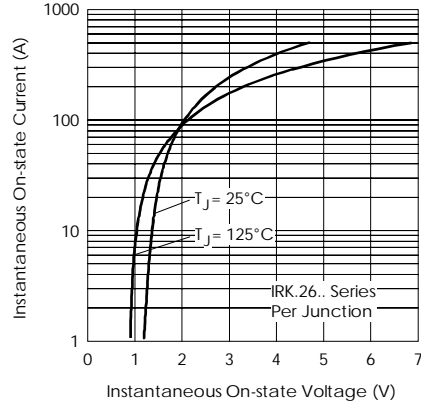

Fig. 10 - On-state Voltage Drop Characteristics

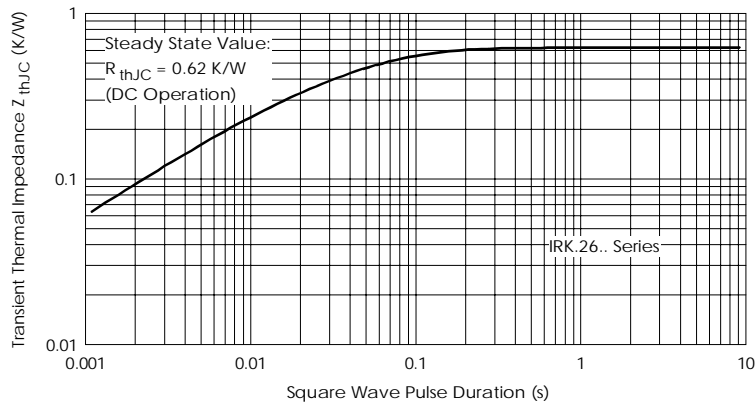

Fig. 11 - Thermal Impedance Z_{thJC} Characteristics

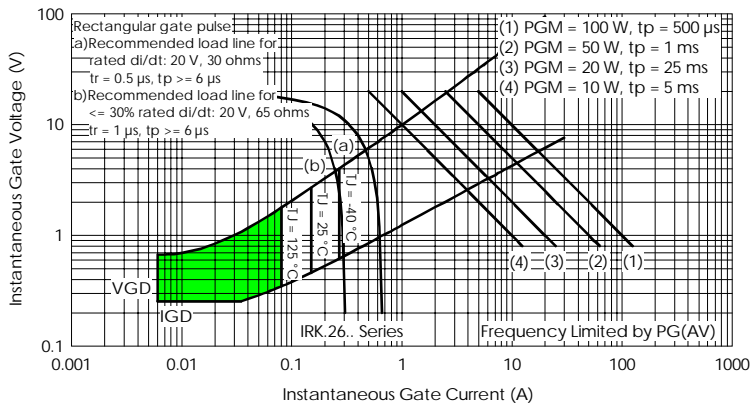

Fig. 12- Gate Characteristics

IRK.26 Series

Bulletin I27130 rev. G 10/02

International
IOR Rectifier

Data and specifications subject to change without notice.
This product has been designed and qualified for Industrial Level.
Qualification Standards can be found on IR's Web site.

International
IOR Rectifier

IR WORLD HEADQUARTERS: 233 Kansas St., El Segundo, California 90245, USA Tel: (310) 252-7105
TAC Fax: (310) 252-7309
Visit us at www.irf.com for sales contact information. 10/02