

# 6MBI100S-120

IGBT Modules

## IGBT MODULE ( S series) 1200V / 100A 6 in one-package

### ■ Features

- Compact package
- P.C.board mount
- Low  $V_{CE(sat)}$

### ■ Applications

- Inverter for motor drive
- AC and DC servo drive amplifier
- Uninterruptible power supply
- Industrial machines, such as welding machines

### ■ Maximum ratings and characteristics

#### ● Absolute maximum ratings ( $T_c=25^\circ\text{C}$ unless otherwise specified)

Item	Symbol	Rating	Unit	
Collector-Emitter voltage	$V_{CES}$	1200	V	
Gate-Emitter voltage	$V_{GES}$	$\pm 20$	V	
Collector current	Continuous	$T_c=25^\circ\text{C}$	150	A
		$T_c=80^\circ\text{C}$	100	
	1ms	$T_c=25^\circ\text{C}$	300	A
		$T_c=80^\circ\text{C}$	200	
	1ms	-Ic	100	A
	-Ic pulse	200	A	
Max. power dissipation (1 device)	$P_c$	700	W	
Operating temperature	$T_j$	+150	$^\circ\text{C}$	
Storage temperature	$T_{stg}$	-40 to +125	$^\circ\text{C}$	
Isolation voltage	$V_{is}$	AC 2500 (1min.)	V	
Screw torque	Mounting *1	3.5	N·m	

\*1 : Recommendable value : 2.5 to 3.5 N·m (M5)

#### ● Electrical characteristics ( $T_j=25^\circ\text{C}$ unless otherwise specified)

Item	Symbol	Characteristics			Conditions	Unit
		Min.	Typ.	Max.		
Zero gate voltage collector current	$I_{CES}$	-	-	1.0	$V_{GE}=0\text{V}$ , $V_{CE}=1200\text{V}$	mA
Gate-Emitter leakage current	$I_{GES}$	-	-	0.2	$V_{CE}=0\text{V}$ , $V_{GE}=\pm 20\text{V}$	$\mu\text{A}$
Gate-Emitter threshold voltage	$V_{GE(th)}$	5.5	7.2	8.5	$V_{CE}=20\text{V}$ , $I_c=100\text{mA}$	V
Collector-Emitter saturation voltage	$V_{CE(sat)}$	-	2.3	2.6	$T_j=25^\circ\text{C}$ , $V_{GE}=15\text{V}$ , $I_c=100\text{A}$	V
		-	2.8	-	$T_j=125^\circ\text{C}$	
Input capacitance	$C_{ies}$	-	12000	-	$V_{GE}=0\text{V}$	pF
Output capacitance	$C_{oes}$	-	2500	-	$V_{CE}=10\text{V}$	
Reverse transfer capacitance	$C_{res}$	-	2200	-	$f=1\text{MHz}$	
Turn-on time	$t_{on}$	-	0.35	1.2	$V_{CC}=600\text{V}$ $I_c=100\text{A}$ $V_{GE}=\pm 15\text{V}$ $R_G=12\Omega$	$\mu\text{s}$
	$t_r$	-	0.25	0.6		
	$t_{r(i)}$	-	0.1	-		
Turn-off time	$t_{off}$	-	0.45	1.0		
	$t_f$	-	0.08	0.3		
Diode forward on voltage	$V_F$	-	2.5	3.3	$T_j=25^\circ\text{C}$ , $I_F=100\text{A}$ , $V_{GE}=0\text{V}$	V
		-	2.0	-	$T_j=125^\circ\text{C}$	
Reverse recovery time	$t_{rr}$	-	-	0.35	$I_F=100\text{A}$	$\mu\text{s}$

#### ● Thermal resistance characteristics

Item	Symbol	Characteristics			Conditions	Unit
		Min.	Typ.	Max.		
Thermal resistance	$R_{th(j-c)}$	-	-	0.18	IGBT	$^\circ\text{C/W}$
	$R_{th(j-c)}$	-	-	0.36	FWD	$^\circ\text{C/W}$
	$R_{th(c-f)*2}$	-	0.05	-	the base to cooling fin	$^\circ\text{C/W}$

\*2 : This is the value which is defined mounting on the additional cooling fin with thermal compound

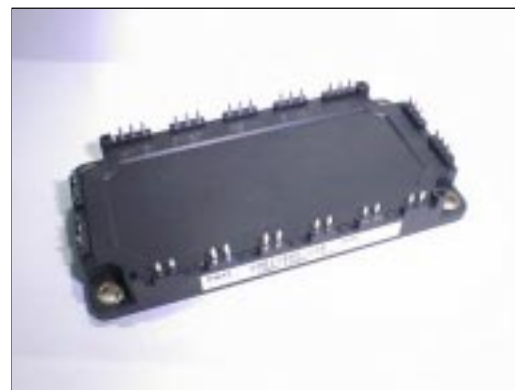

### ■ Equivalent Circuit Schematic

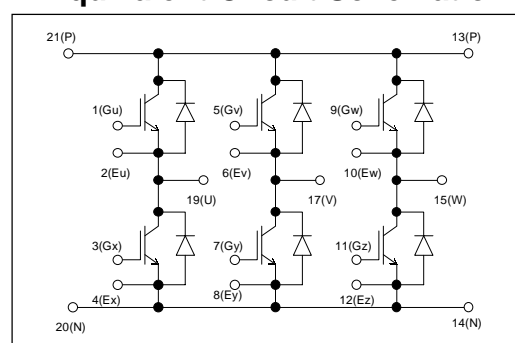

Characteristics

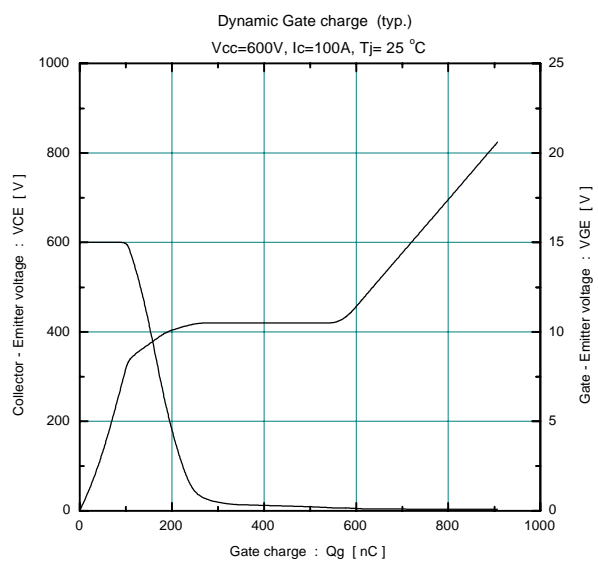
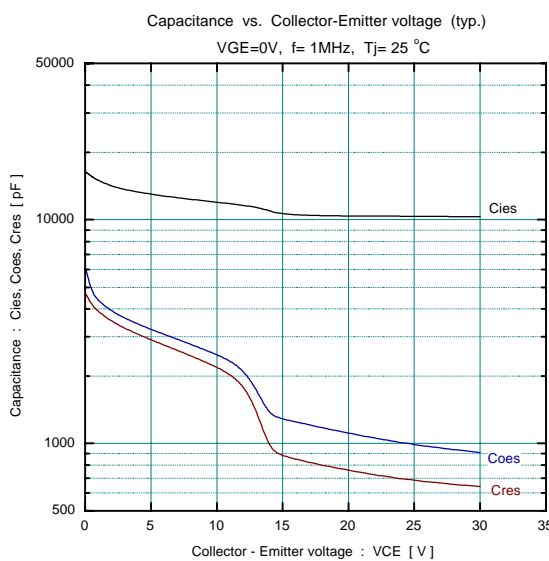
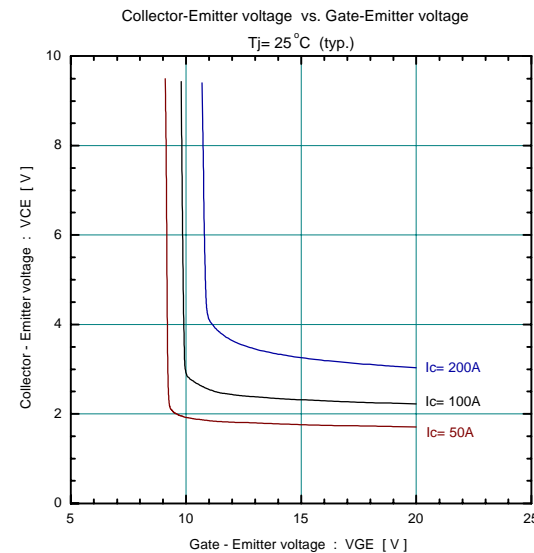
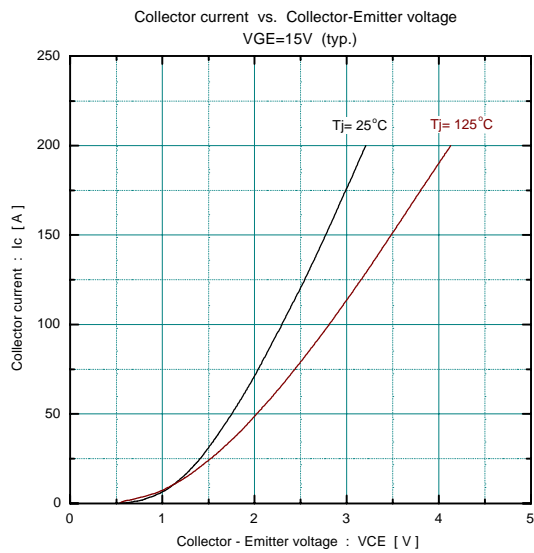
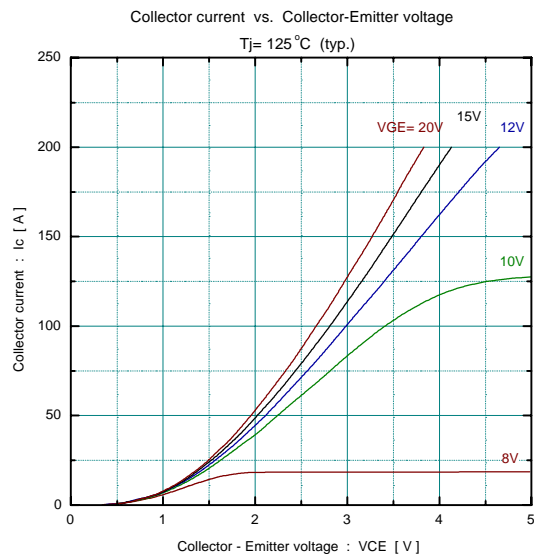
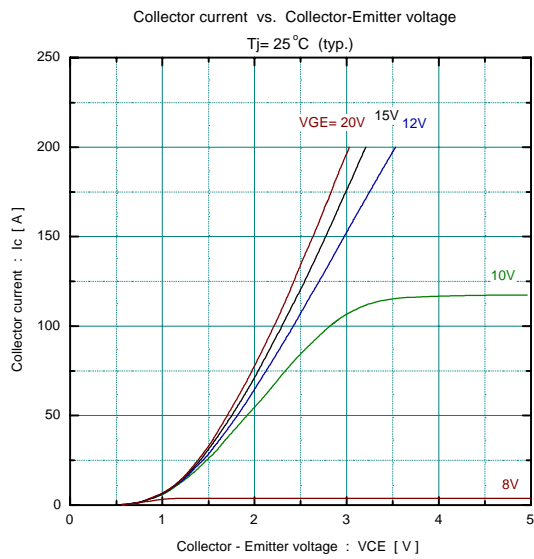

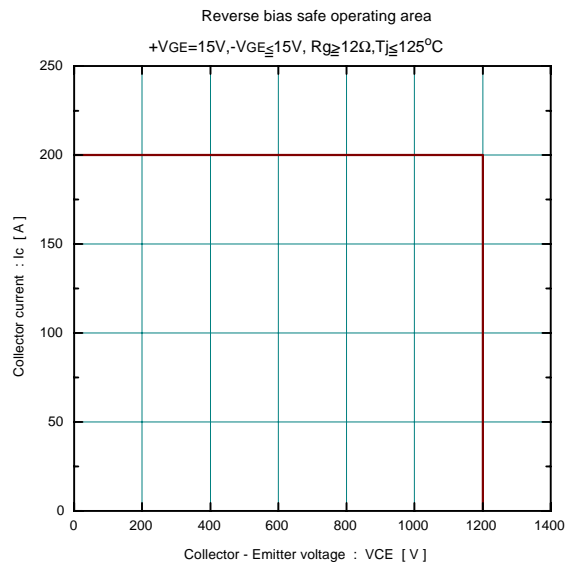
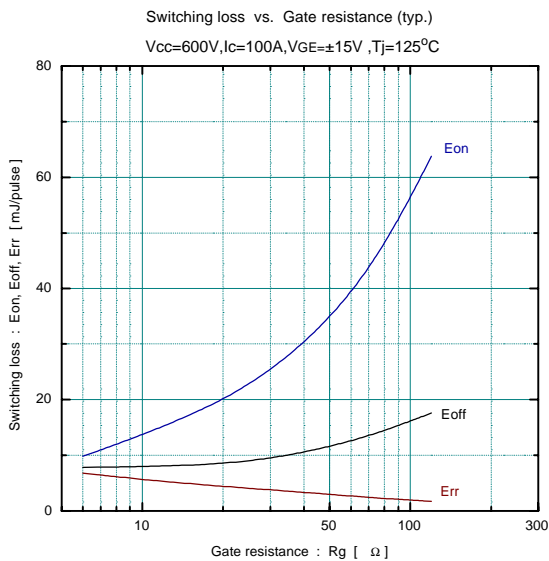
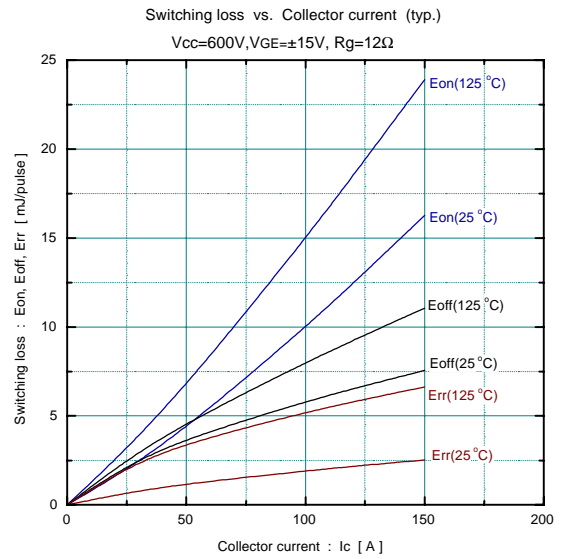
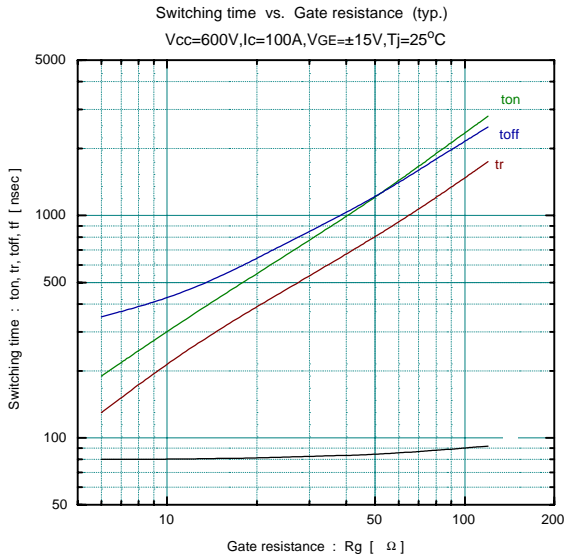
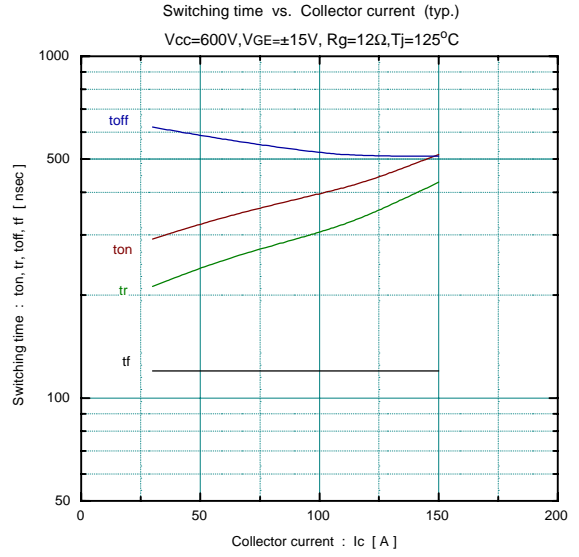
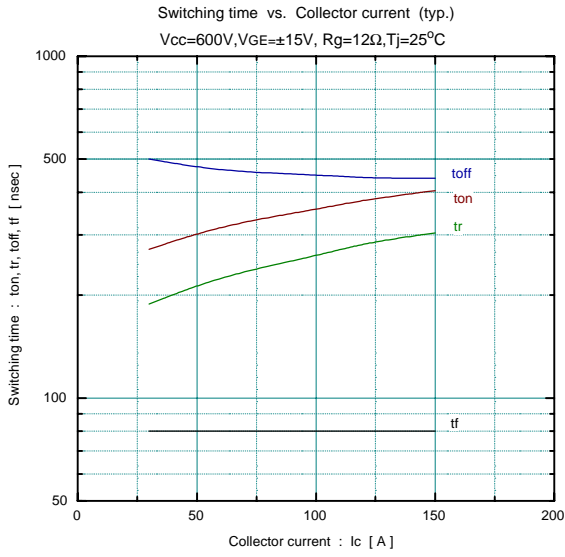

Forward current vs. Forward on voltage (typ.)

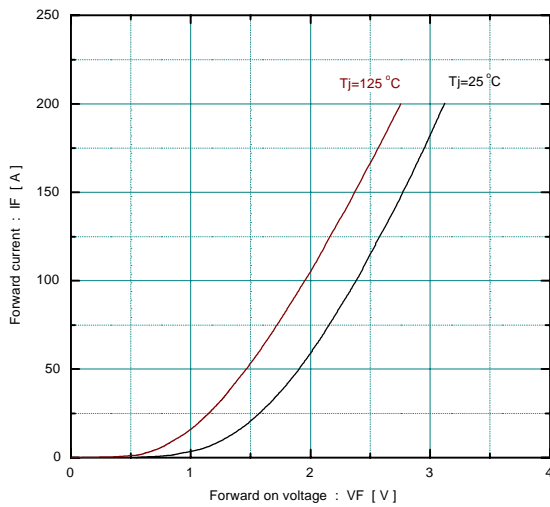

Reverse recovery characteristics (typ.)

Vcc=600V, VGE=±15V, Rg=12Ω

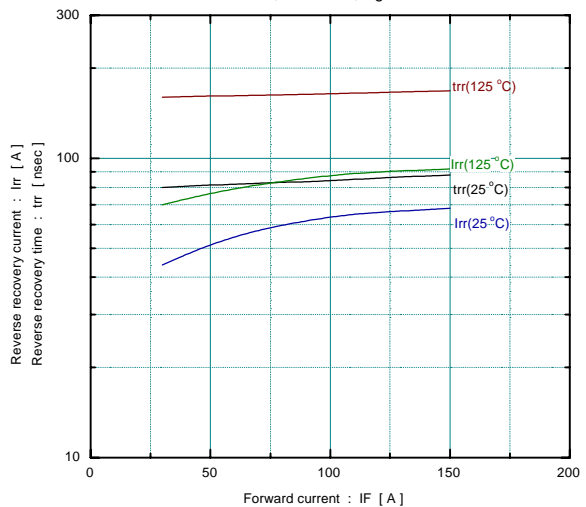

Transient thermal resistance

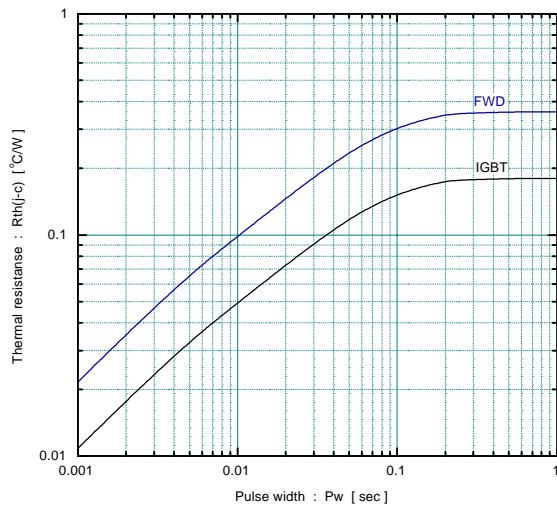

■ Outline Drawings, mm

