

IEC Appliance Inlet C14 with Filter, Fuseholder 2-pole, Line Switch 2-pole

Standard- or Medical-Filter



Aluminum



Nickel plated steel



Description

- Panel Mount:
Screw-on mounting from front side
- 4 Functions:
Appliance Inlet Protection class I, Line Switch 2-pole, Fuseholder for fuse-links 5 x 20 mm 2-pole, Line filter in standard and medical version
- Quick connect terminals 6.3 x 0.8 mm

Approvals

- VDE Certificate Number: 40004665
- UL File Number: E72928

Characteristics

- Compact design with optimal shielding
- All single elements are already wired
- Plug removal necessary for fuse-link replacement
If the power entry module is installed as normal, it is not possible to touch any live parts with the test-finger according to IEC60529
Fuse drawer meets requirements of medical standard IEC/EN 60601-1
The fuseholder is accessible from the equipment front
- With EMC-shield
- Qualified for use in equipment according IEC/EN 60950

Other versions on request

- Medical version M80

References

Weblinks

[pdf](#), [html](#), [General Product Information](#), [Approvals](#), [RoHS](#), [CHINA-RoHS](#), [Mating Connectors](#), [e-Store](#), [SCHURTER-Stock-Check](#), [Distributor-Stock-Check](#), [Accessories](#)

Technical Data

| | |
|---------------------------|---|
| Ratings IEC | 1 - 10A @ Ta 40 °C / 250VAC; 50Hz |
| Ratings UL/CSA | 1 - 10A @ Ta 40 °C / 125VAC; 60Hz |
| Leakage Current | standard < 0.25 mA (250 V / 60Hz) medical < 5 µA (250 V / 60 Hz) |
| Dielectric Strength | > 1.7 kVDC between L-N > 2.7 kVDC between L/N-PE Test voltage (2 sec) |
| Allowable Operation Temp. | -25 °C to 85 °C |
| Climatic Category | 25/085/21 acc. to IEC 60068-1 |
| Degree of Protection | from front side IP 40 acc. to IEC 60529 |
| Protection Class | Suitable for appliances with protection class 1 acc. to IEC 61140 |
| Terminal | Quick connect terminals 6.3 x 0.8 mm |
| Panel Thickness s | Screw: max 8 mm Mounting screw torque max 0.5 Nm |
| Material: Housing | Thermoplastic, black, UL 94V-0 |

| | |
|-----------------------------------|---|
| Appliance-Inlet/-Outlet | C14 acc. to IEC/EN 60320-1, UL 498, CSA C22.2 no. 42 (for cold conditions) pin-temperature 70 °C, 10A, Protection Class 1 |
| Fuseholder | 2-pole, Shocksafe category PC2 acc. to IEC 60127-6, for fuse-links 5 x 20 mm |
| Rated Power Acceptance @ Ta 23 °C | 5 x 20: 1.6W (2-pole) |
| Power Acceptance @ Ta > 23°C | Admissible power acceptance at higher ambient temperature see derating curves |
| Line Switch | Rocker switch 2-pole, non-illuminated, acc. to IEC 61058-1 Technical details |
| Line Filter | Standard and Medical Version, IEC 60939, IEC 60601-1, UL 1283, UL 544, EN 133 200, CSA C22.2 no. 8 Technical details |
| MTBF | > 1'700'000h acc. to MIL-HB-217 F |

Dimensions

Case 45

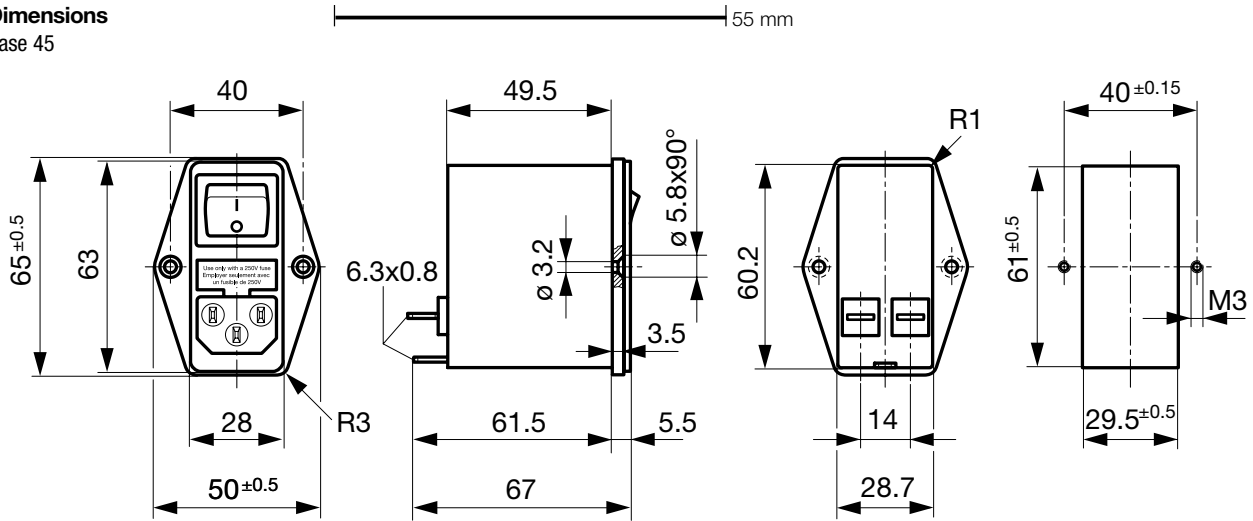

Case 50

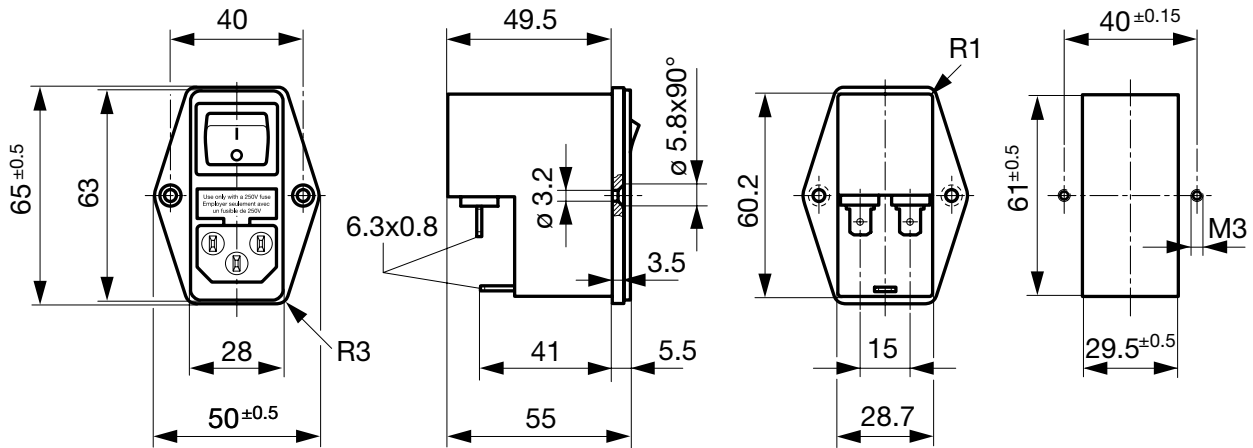

Technical Data of Filter-Components

| Rated Current [A] | Filter-Type | Inductances L [mH] | Capacitance CX [nF] | Capacitance CY [nF] | R [MΩ] |
|-------------------|----------------------|--------------------|---------------------|---------------------|--------|
| 1 | Standard Version | 2 x 10 | 68 | 2.2 | 1 |
| 2 | Standard Version | 2 x 4 | 68 | 2.2 | 1 |
| 4 | Standard Version | 2 x 1.5 | 68 | 2.2 | 1 |
| 6 | Standard Version | 2 x 0.8 | 68 | 2.2 | 1 |
| 10 | Standard Version | 2 x 0.3 | 68 | 2.2 | 1 |
| 1 | Medical Version (M5) | 2 x 10 | 68 | - | 1 |
| 2 | Medical Version (M5) | 2 x 4 | 68 | - | 1 |
| 4 | Medical Version (M5) | 2 x 1.5 | 68 | - | 1 |
| 6 | Medical Version (M5) | 2 x 0.8 | 68 | - | 1 |
| 10 | Medical Version (M5) | 2 x 0.3 | 68 | - | 1 |

Diagrams

Standard version

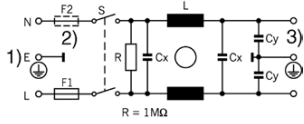

- 1) Line
- 2) only FKI
- 3) Load

Medical version

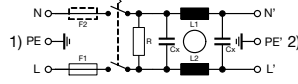

- 1) Line
- 2) Load

Derating Curves

2-pole

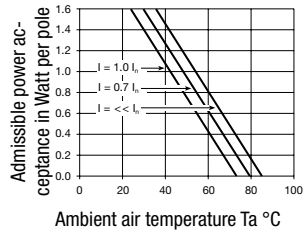

Attenuation Loss

Standard version

--- differential mode ____ common mode

1 A

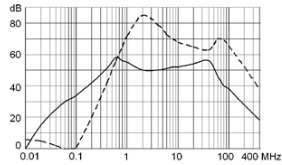

2 A

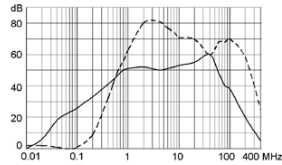

4 A

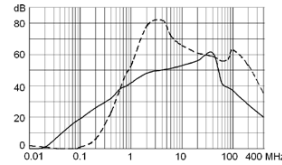

6 A

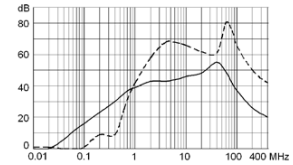

10 A

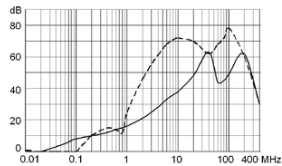

Medical version (M5)

1 A

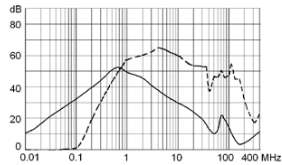

2 A

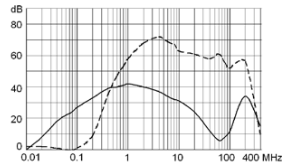

4 A

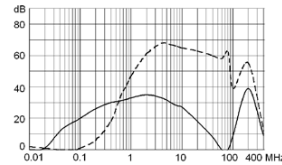

6 A

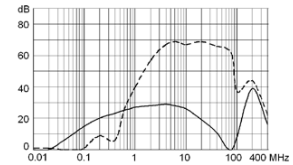

10 A

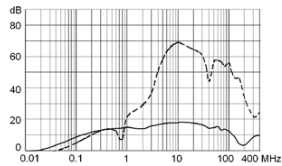

Variants

Socket and fuse drawer included

| Type | Rated Current [A] | Filter-Type | Fuseholder | Line Switch | Housing | Material: Housing | Comment | Order Number |
|------|-------------------|----------------------|------------|-------------|---------|---------------------|---------|--------------|
| FKI | 1 | Standard Version | 2-pole | 2-pole | 45 | Aluminum | - | 4304.4061 |
| FKI | 2 | Standard Version | 2-pole | 2-pole | 45 | Aluminum | - | 4304.4062 |
| FKI | 4 | Standard Version | 2-pole | 2-pole | 45 | Aluminum | - | 4304.4063 |
| FKI | 6 | Standard Version | 2-pole | 2-pole | 45 | Aluminum | - | 4304.4064 |
| FKI | 10 | Standard Version | 2-pole | 2-pole | 45 | Aluminum | - | 4304.4065 |
| FKI | 1 | Medical Version (M5) | 2-pole | 2-pole | 45 | Aluminum | - | 4304.4091 |
| FKI | 2 | Medical Version (M5) | 2-pole | 2-pole | 45 | Aluminum | - | 4304.4092 |
| FKI | 4 | Medical Version (M5) | 2-pole | 2-pole | 45 | Aluminum | - | 4304.4092 |
| FKI | 6 | Medical Version (M5) | 2-pole | 2-pole | 45 | Aluminum | - | 4304.4094 |
| FKI | 10 | Medical Version (M5) | 2-pole | 2-pole | 45 | Aluminum | - | 4304.4095 |
| FKI | 1 | Standard Version | 2-pole | 2-pole | 50 | Nickel plated steel | - | 4304.4021 |
| FKI | 2 | Standard Version | 2-pole | 2-pole | 50 | Nickel plated steel | - | 4304.4022 |
| FKI | 4 | Standard Version | 2-pole | 2-pole | 50 | Nickel plated steel | - | 4304.4023 |
| FKI | 6 | Standard Version | 2-pole | 2-pole | 50 | Nickel plated steel | - | 4304.4024 |
| FKI | 10 | Standard Version | 2-pole | 2-pole | 50 | Nickel plated steel | - | 4304.4025 |
| FKI | 1 | Medical Version (M5) | 2-pole | 2-pole | 50 | Nickel plated steel | - | 4304.4066 |
| FKI | 2 | Medical Version (M5) | 2-pole | 2-pole | 50 | Nickel plated steel | - | 4304.4067 |
| FKI | 4 | Medical Version (M5) | 2-pole | 2-pole | 50 | Nickel plated steel | - | 4304.4068 |
| FKI | 6 | Medical Version (M5) | 2-pole | 2-pole | 50 | Nickel plated steel | - | 4304.4069 |
| FKI | 10 | Medical Version (M5) | 2-pole | 2-pole | 50 | Nickel plated steel | - | 4304.4070 |

Packaging unit 10 Pcs

Accessories

Description

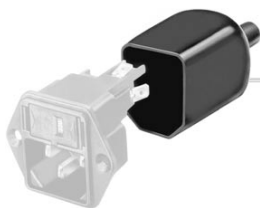
Assorted Covers
Rear Cover

0859.0074

Mating Outlets/Connectors

Category / Description

Appliance Outlet Overview complete



| | |
|---|------|
| IEC Appliance Outlet F, Screw-on Mounting, Front Side, Solder Terminal | 4787 |
| IEC Appliance Outlet F, Snap-in Mounting, Front Side, Solder or Quick-connect Terminal | 4788 |
| IEC Appliance Outlet F or H, Screw-on Mounting, Front Side, Solder, PCB or Quick-connect Terminal | 5091 |
| IEC Appliance Outlet F or H, Screw-on Mounting, Front Side, Solder or Quick-connect Terminal | 5092 |

Appliance Outlet further types to FKI

Connector Overview complete



| | |
|--|--------|
| IEC Connector C15, Rewireable, Straight | 0101 |
| IEC Connector C15A, Rewireable, Straight | 0102 |
| IEC Connector C15A, Rewireable, Straight | 0102-G |
| IEC Connector C15A, Rewireable, Angled | 0112 |
| IEC Connector C13, Rewireable, Angled | 4012 |

Connector further types to FKI

...

Category / Description



[Power Cord Overview complete](#)

| | |
|---|------|
| Power Cord with IEC Connector C13, Angled | 0311 |
| Power Cord with IEC Connector C13, Angled | 3011 |
| Power Cord with IEC Connector C13, Angled | 3012 |
| Power Cord with IEC Connector C13, Angled | 3013 |
| Power Cord with IEC Connector C13 | 3020 |
| Power Cord further types to FKI | ... |