

IEC Appliance Inlet C14 with Filter, Fuseholder 1-pole, Line Switch 2-pole

Standard- or Medical-Filter



Aluminum



Nickel plated steel

**Description**

- Panel Mount:
Screw-on mounting from front side
- 4 Functions:
Appliance Inlet Protection class I, Line Switch 2-pole, Fuseholder for fuse-links 5 x 20 mm 1-pole, Line-filter in standard version
- Quick connect terminals 6.3 x 0.8 mm

Approvals

- VDE Certificate Number: 40004665
- UL File Number: E72928

Characteristics

- Compact design with optimal shielding
- All single elements are already wired
- Plug removal necessary for fuse-link replacement
If the power entry module is installed as normal, it is not possible to touch any live parts with the test-finger according to IEC60529
Fuse drawer meets requirements of medical standard IEC/EN 60601-1
The fuseholder is accessible from the equipment front
- With EMC-shield
- Qualified for use in equipment according IEC/EN 60950

Other versions on request

- Medical version M80

References**Weblinks**

[pdf](#), [html](#), [General Product Information](#), [Approvals](#), [RoHS](#), [CHINA-RoHS](#), [Mating Connectors](#), [e-Store](#), [SCHURTER-Stock-Check](#), [Distributor-Stock-Check](#), [Accessories](#)

Technical Data

Ratings IEC	1 - 10A @ Ta 40 °C / 250VAC; 50Hz
Ratings UL/CSA	1 - 10A @ Ta 40 °C / 125VAC; 60Hz
Leakage Current	standard < 0.25mA (250V / 60Hz)
Dielectric Strength	> 1.7 kVDC between L-N > 2.7 kVDC between L/N-PE Test voltage (2 sec)
Allowable Operation Temp.	-25 °C to 85 °C
Climatic Category	25/085/21 acc. to IEC 60068-1
Degree of Protection	from front side IP 40 acc. to IEC 60529
Protection Class	Suitable for appliances with protection class 1 acc. to IEC 61140
Terminal	Quick connect terminals 6.3 x 0.8 mm
Panel Thickness s	Screw: max 8 mm Mounting screw torque max 0.5 Nm
Material: Housing	Thermoplastic, black, UL 94V-0

Appliance-Inlet/-Outlet	C14 acc. to IEC/EN 60320-1, UL 498, CSA C22.2 no. 42 (for cold conditions) pin-temperature 70 °C, 10A, Protection Class 1
Fuseholder	1-pole, Shocksafe category PC2 acc. to IEC 60127-6, for fuse-links 5 x 20 mm
Rated Power Acceptance @ Ta 23 °C	5 x 20: 1.6W (1 pole)
Power Acceptance @ Ta > 23°C	Admissible power acceptance at higher ambient temperature see derating curves
Line Switch	Rocker switch 2-pole, non-illuminated, acc. to IEC 61058-1 Technical details
Line Filter	Standard Version, IEC 60939, IEC 60601-1, UL 1283, UL 544, EN 133 200, CSA C22.2 no. 8 Technical details
MTBF	> 1'700'000h acc. to MIL-HB-217 F

Dimensions

Case 45

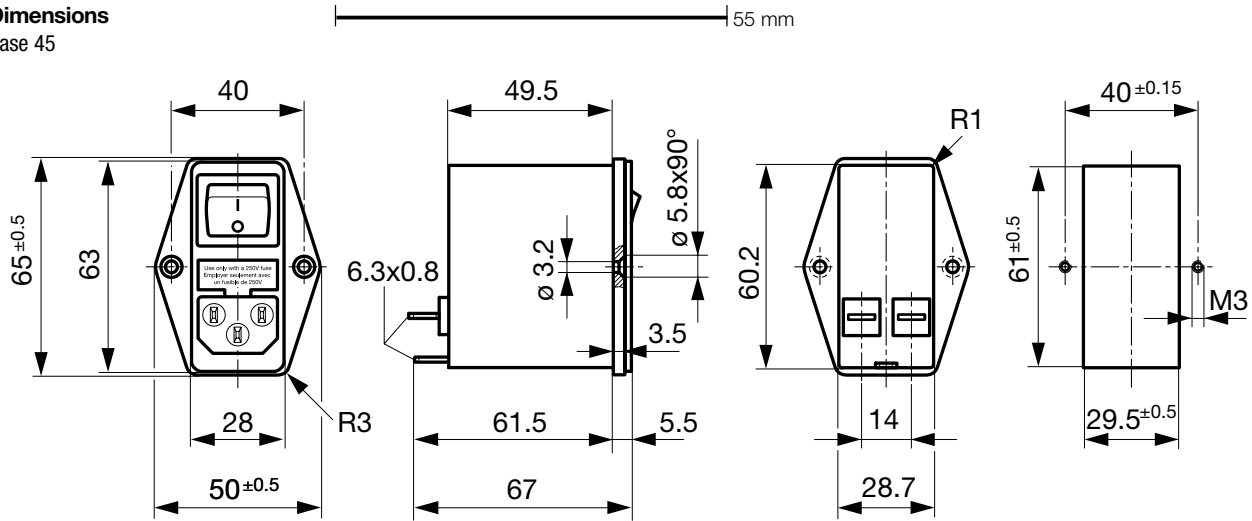

Case 50

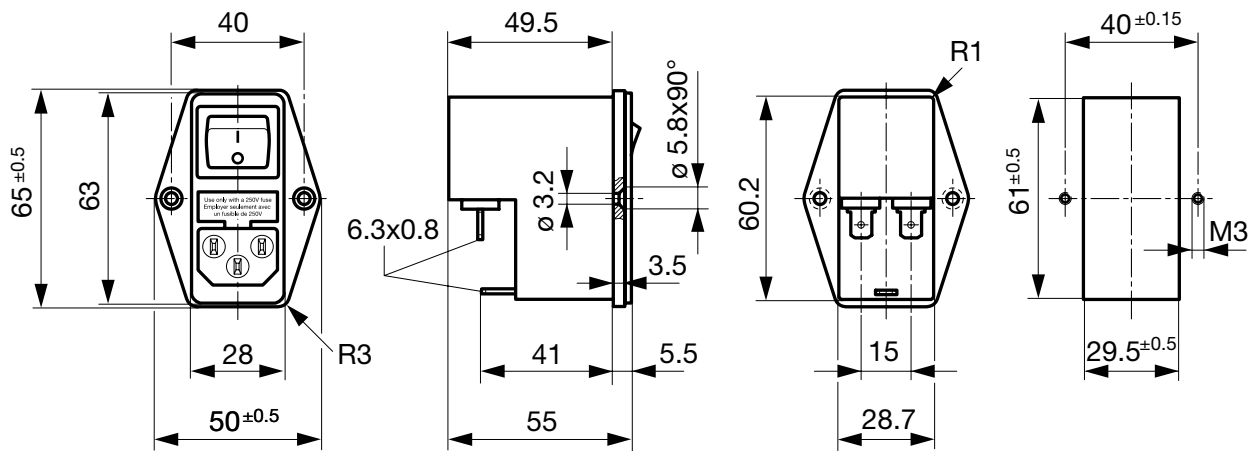

Technical Data of Filter-Components

Rated Current [A]	Filter-Type	Inductances L [mH]	Capacitance CX [nF]	Capacitance CY [nF]	R [MΩ]
1	Standard Version	2 x 10	68	2.2	1
2	Standard Version	2 x 4	68	2.2	1
4	Standard Version	2 x 1.5	68	2.2	1
6	Standard Version	2 x 0.8	68	2.2	1
10	Standard Version	2 x 0.3	68	2.2	1
1	Medical Version (M5)	2 x 10	68	-	1
2	Medical Version (M5)	2 x 4	68	-	1
4	Medical Version (M5)	2 x 1.5	68	-	1
6	Medical Version (M5)	2 x 0.8	68	-	1
10	Medical Version (M5)	2 x 0.3	68	-	1

Diagrams

Standard version

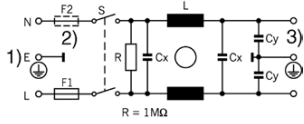

- 1) Line
- 2) only FKI
- 3) Load

Medical version

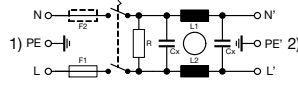

- 1) Line
- 2) Load

Derating Curves

1-pole

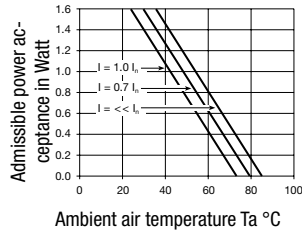

Attenuation Loss

Standard version

--- differential mode ____ common mode

1 A

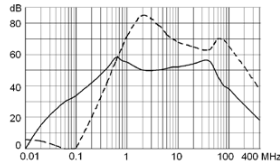

2 A

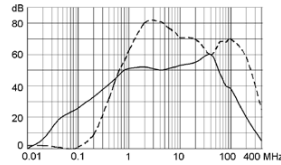

4 A

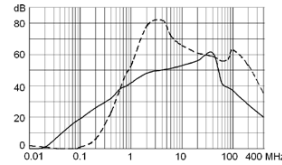

6 A

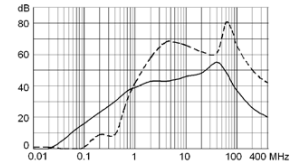

10 A

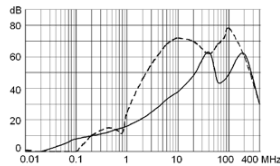

Medical version (M5)

1 A

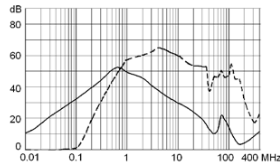

2 A

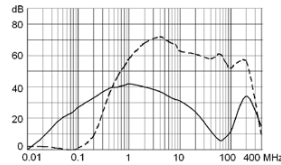

4 A

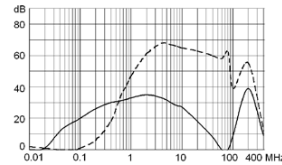

6 A

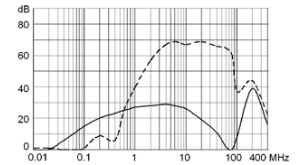

10 A

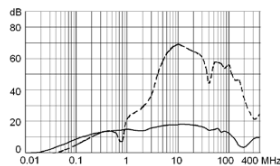

Variants

Socket and fuse drawer included

Type	Rated Current [A]	Filter-Type	Fuseholder	Line Switch	Housing	Material: Housing	Comment	Order Number
FKH	1	Standard Version	1-pole	2-pole	45	Aluminum	-	4304.4041
FKH	2	Standard Version	1-pole	2-pole	45	Aluminum	-	4304.4042
FKH	4	Standard Version	1-pole	2-pole	45	Aluminum	-	4304.4043
FKH	6	Standard Version	1-pole	2-pole	45	Aluminum	-	4304.4044
FKH	10	Standard Version	1-pole	2-pole	45	Aluminum	-	4304.4045
FKH	1	Medical Version (M5)	1-pole	2-pole	45	Aluminum	-	4304.4046
FKH	2	Medical Version (M5)	1-pole	2-pole	45	Aluminum	-	4304.4047
FKH	4	Medical Version (M5)	1-pole	2-pole	45	Aluminum	-	4304.4048
FKH	6	Medical Version (M5)	1-pole	2-pole	45	Aluminum	-	4304.4049
FKH	10	Medical Version (M5)	1-pole	2-pole	45	Aluminum	-	4304.4050
FKH	1	Standard Version	1-pole	2-pole	50	Nickel plated steel	-	4304.4001
FKH	2	Standard Version	1-pole	2-pole	50	Nickel plated steel	-	4304.4002
FKH	4	Standard Version	1-pole	2-pole	50	Nickel plated steel	-	4304.4003
FKH	6	Standard Version	1-pole	2-pole	50	Nickel plated steel	-	4304.4004
FKH	10	Standard Version	1-pole	2-pole	50	Nickel plated steel	-	4304.4005

Packaging unit 10 Pcs

Accessories

Description

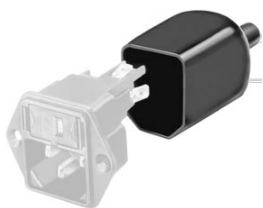

Assorted Covers
Rear Cover

Mating Outlets/Connectors

Category / Description

Appliance Outlet Overview complete



IEC Appliance Outlet F, Screw-on Mounting, Front Side, Solder Terminal	4787
IEC Appliance Outlet F, Snap-in Mounting, Front Side, Solder or Quick-connect Terminal	4788
IEC Appliance Outlet F or H, Screw-on Mounting, Front Side, Solder, PCB or Quick-connect Terminal	5091
IEC Appliance Outlet F or H, Screw-on Mounting, Front Side, Solder or Quick-connect Terminal	5092

[Appliance Outlet further types to FKH](#)

Connector Overview complete



IEC Connector C15, Rewireable, Straight	0101
IEC Connector C15A, Rewireable, Straight	0102
IEC Connector C15A, Rewireable, Straight	0102-G
IEC Connector C15A, Rewireable, Angled	0112
IEC Connector C13, Rewireable, Angled	4012

[Connector further types to FKH](#)

...

Category / Description

[Power Cord Overview complete](#)

Power Cord with IEC Connector C13, Angled	0311
Power Cord with IEC Connector C13, Angled	3011
Power Cord with IEC Connector C13, Angled	3012
Power Cord with IEC Connector C13, Angled	3013
Power Cord with IEC Connector C13	3020
Power Cord further types to FKH	...