

## FEATURES

- SHIELDED POWER INDUCTOR
- HIGH CURRENT, SMALL SIZE (UP TO 7 AMPS)
- SURFACE MOUNTABLE CONSTRUCTION
- HIGH INDUCTANCE (UP TO 10,000 $\mu$ H)
- TAPED AND REELED FOR AUTOMATIC INSERTION
- FOR USE IN DC/DC CONVERTERS

**RoHS Compliant**  
includes all homogeneous materials

\*See Part Number System for Details

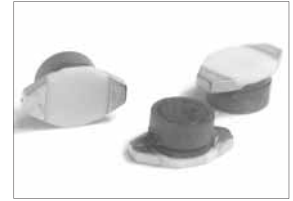

## CHARACTERISTICS

Case Size	NPIS16R	NPIS22R	NPIS30R	NPIS31R	NPIS52R
Inductance Range	1 ~ 10000 $\mu$ H	2.2 ~ 1000 $\mu$ H	2.2 ~ 470 $\mu$ H	1.0 ~ 390 $\mu$ H	10 ~ 1000 $\mu$ H
Temperature Range	-40°C ~ +125°C				
Temperature Rise at Irms	+30°C max.	+40°C max.			
Inductance Change at Isat	-30% typical (NPIS16R), -10% typical (All Other Case Sizes)				
Inductance Tolerance	10% (K), 15% (L), 20% (M)				
Resistance to Solder Heat	260°C for 10 seconds				

## DIMENSIONS (mm)

Series	A	B	C	D	E	F	G	H	I
NPIS16R	4.45 Max	6.6 Max	2.92 Max	1.02 $\pm$ 0.2	1.27 $\pm$ 0.2	4.32 $\pm$ 0.3	4.06	3.56	1.4
NPIS22R	8.00 $\pm$ 0.2	10.5 $\pm$ 0.2	5.0 $\pm$ 0.3	2.1 $\pm$ 0.2	2.0 $\pm$ 0.2	6.0 $\pm$ 0.3	5.7	2.2	2.4
NPIS30R	10.0 $\pm$ 0.2	12.7 $\pm$ 0.2	3.0 $\pm$ 0.3	2.4 $\pm$ 0.2	2.2 $\pm$ 0.2	7.6 $\pm$ 0.3	7.3	2.8	3.0
NPIS31R	10.0 $\pm$ 0.2	12.7 $\pm$ 0.2	5.0 $\pm$ 0.3	2.4 $\pm$ 0.2	2.2 $\pm$ 0.2	7.6 $\pm$ 0.3	7.3	2.8	3.0
NPIS52R	15.0 $\pm$ 0.3	18.4 $\pm$ 0.3	7.0 $\pm$ 0.5	2.4 $\pm$ 0.2	2.2 $\pm$ 0.2	13.3 $\pm$ 0.3	12.7	2.8	3.0

### NPIS16R

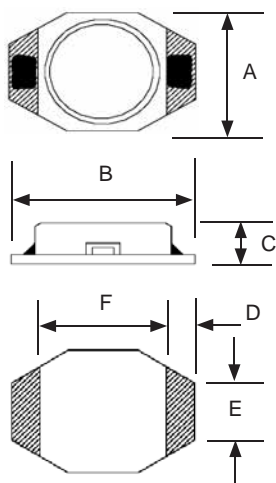

### NPIS22R, 30W, 31R AND 52R

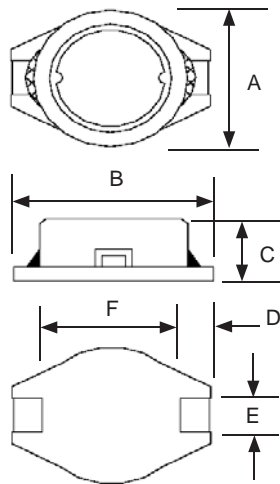

### REFLOW SOLDERING PROFILE

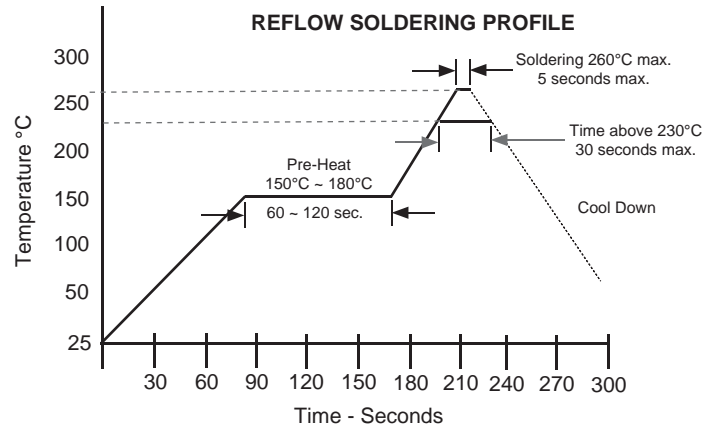

### LAND PATTERN

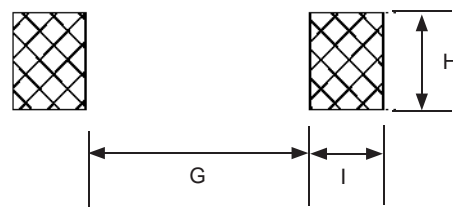

## PART NUMBER SYSTEM

NPIS 22 R 102 K TR F

Termination Finish:  
F = Pb-free/RoHS Compliant (100%Sn)

Packaging: TR = Tape & Reel

Inductance Tolerance Code: K=10%, L=15% M= $\pm$ 20%

Inductance Code ( $\mu$ H): 1st two digits are significant,  
3rd digit is multiplier for values from 10 $\mu$ H and up.

Construction Code (see drawing for details)

Size Code (see table for details)

Series



Part Number	STANDARD VALUES - CASE SIZE 16 (4.45 x 6.6 x 2.92mm)				Test Frequency
	Inductance Value (µH)	SRF (Typical) MHz	DC Resistance (Ω)	DC Current Isat/Irms (Amps)	
NPIS16R1R0MTRF	1.0±20%	250	0.040	3.0	100KHz
NPIS16R1R5MTRF	1.5±20%	125	0.045	2.3	
NPIS16R2R2MTRF	2.2±20%	120	0.050	1.8	
NPIS16R3R3MTRF	3.3±20%	120	0.055	1.6	
NPIS16R4R7MTRF	4.7±20%	105	0.060	1.4	
NPIS16R6R8MTRF	6.8±20%	50	0.065	1.2	
NPIS16R100MTRF	10±20%	38	0.075	1.0	
NPIS16R150MTRF	15±20%	33	0.090	0.80	
NPIS16R220MTRF	22±20%	25	0.110	0.70	
NPIS16R330MTRF	33±20%	20	0.190	0.60	
NPIS16R470MTRF	47±20%	20	0.230	0.50	
NPIS16R680MTRF	68±20%	15	0.290	0.40	
NPIS16R101MTRF	100±20%	10	0.480	0.30	
NPIS16R151MTRF	150±20%	9.0	0.590	0.26	
NPIS16R221MTRF	220±20%	6.0	0.770	0.22	
NPIS16R331MTRF	330±20%	5.0	1.40	0.20	
NPIS16R471MTRF	470±20%	4.0	1.80	0.19	
NPIS16R681MTRF	680±20%	3.0	2.20	0.16	
NPIS16R102MTRF	1000±20%	2.0	3.40	0.15	
NPIS16R152MTRF	1500±20%	2.0	4.20	0.12	
NPIS16R222MTRF	2200±20%	2.0	8.50	0.10	
NPIS16R332MTRF	3300±20%	1.0	11.0	0.08	
NPIS16R472MTRF	4700±20%	1.0	13.9	0.06	
NPIS16R682MTRF	6800±20%	1.0	25.0	0.04	
NPIS16R103MTRF	10000±20%	0.8	32.8	0.02	

Maximum +30°C temperature rise at Irms. Typical -30% inductance change at Isat.



Part Number	STANDARD VALUES - CASE SIZE 22 (8.0 x 10.5 x 5.0mm)					Test Frequency
	Inductance Value (μH)	SRF (Typical) MHz	DC Resistance (Ω)	DC Current I <sub>rms</sub> (Amps)	DC Current I <sub>sat</sub> (Amps)	
NPIS22R2R2MTRF	2.2 ± 20%	75.0	0.040	2.50	6.0	100KHz
NPIS22R3R9MTRF	3.9 ± 20%	50.0	0.055	2.10	4.5	
NPIS22R5R6MTRF	5.6 ± 20%	40.0	0.065	1.95	4.0	
NPIS22R8R2MTRF	8.2 ± 20%	32.0	0.080	1.75	3.0	
NPIS22R100MTRF	10 ± 20%	28.0	0.100	1.50	2.5	
NPIS22R120MTRF	12 ± 20%	24.0	0.120	1.40	2.0	
NPIS22R150MTRF	15 ± 20%	22.0	0.140	1.30	1.8	
NPIS22R180LTRF	18 ± 15%	19.0	0.160	1.20	1.6	
NPIS22R220LTRF	22 ± 15%	17.0	0.180	1.10	1.5	
NPIS22R270LTRF	27 ± 15%	15.5	0.200	1.00	1.4	
NPIS22R330LTRF	33 ± 15%	13.5	0.240	0.92	1.3	
NPIS22R390LTRF	39 ± 15%	12.0	0.260	0.84	1.0	
NPIS22R470LTRF	47 ± 15%	10.50	0.280	0.75	0.90	
NPIS22R560KTRF	56 ± 10%	9.50	0.380	0.68	0.80	
NPIS22R680KTRF	68 ± 10%	9.00	0.440	0.60	0.70	
NPIS22R820KTRF	82 ± 10%	8.50	0.550	0.54	0.60	
NPIS22R101KTRF	100 ± 10%	7.50	0.600	0.50	0.50	
NPIS22R121KTRF	120 ± 10%	7.00	0.750	0.45	0.45	
NPIS22R151KTRF	150 ± 10%	6.50	0.900	0.40	0.40	
NPIS22R181KTRF	180 ± 10%	4.80	1.05	0.35	0.37	
NPIS22R221KTRF	220 ± 10%	4.50	1.18	0.30	0.35	
NPIS22R271KTRF	270 ± 10%	4.20	1.40	0.27	0.32	
NPIS22R331KTRF	330 ± 10%	3.80	1.80	0.24	0.30	
NPIS22R391KTRF	390 ± 10%	3.60	2.10	0.22	0.28	
NPIS22R471KTRF	470 ± 10%	3.50	2.25	0.20	0.26	
NPIS22R561KTRF	560 ± 20%	3.00	3.00	0.18	0.25	
NPIS22R681KTRF	680 ± 20%	2.80	3.40	0.17	0.23	
NPIS22R821KTRF	820 ± 20%	2.50	4.00	0.16	0.22	
NPIS22R102KTRF	1000 ± 20%	2.20	5.00	0.15	0.20	

Maximum +40°C temperature rise at I<sub>rms</sub>. Typical -10% inductance change at I<sub>sat</sub>.

Part Number	STANDARD VALUES - CASE SIZE 30 (10.0 x 12.7 x 3.0mm)					Test Frequency
	Inductance Value (μH)	SRF (Typical) MHz	DC Resistance (Ω)	DC Current I <sub>rms</sub> (Amps)	DC Current I <sub>sat</sub> (Amps)	
NPIS30R2R2MTRF	2.2 ± 20%	90	0.045	3.50	4.20	100KHz
NPIS30R3R0MTRF	3.0 ± 20%	70	0.062	3.00	3.60	
NPIS30R3R9MTRF	3.0 ± 20%	60	0.070	2.80	3.40	
NPIS30R4R7MTRF	4.7 ± 20%	50	0.078	2.50	3.00	
NPIS30R6R8MTRF	6.8 ± 20%	50	0.100	2.20	2.60	
NPIS30R100MTRF	10 ± 20%	38	0.145	2.00	2.20	
NPIS30R120MTRF	12 ± 20%	29	0.185	1.75	2.00	
NPIS30R150MTRF	15 ± 20%	30	0.200	1.50	1.80	
NPIS30R180MTRF	18 ± 20%	25	0.270	1.40	1.60	
NPIS30R220MTRF	22 ± 20%	22	0.300	1.30	1.50	
NPIS30R270MTRF	27 ± 20%	18	0.400	1.20	1.30	
NPIS30R330MTRF	33 ± 20%	17	0.450	1.10	1.20	
NPIS30R390MTRF	39 ± 20%	17	0.560	0.95	1.10	
NPIS30R470MTRF	47 ± 20%	15	0.650	0.80	1.05	
NPIS30R560MTRF	56 ± 20%	14	0.680	0.75	1.00	
NPIS30R680MTRF	68 ± 20%	12	0.800	0.70	0.90	
NPIS30R820MTRF	82. ± 20%	11	1.20	0.65	0.85	
NPIS30R101MTRF	100 ± 20%	9.5	1.40	0.60	0.80	
NPIS30R121MTRF	120.± 20%	8.5	1.52	0.55	0.70	
NPIS30R151MTRF	150 ± 20%	8	1.80	0.50	0.65	
NPIS30R181MTRF	180 ± 20%	7	2.20	0.45	0.60	
NPIS30R221MTRF	220 ± 20%	6.5	2.20	0.40	0.50	
NPIS30R271LTRF	270 ± 15%	5.5	3.10	0.35	0.45	
NPIS30R331LTRF	330 ± 15%	5.2	3.60	0.30	0.40	
NPIS30R391LTRF	390 ± 15%	5	4.60	0.25	0.35	
NPIS30R471LTRF	470 ± 15%	4.5	5.10	0.20	0.30	

Maximum +40°C temperature rise at I<sub>rms</sub>. Typical -10% inductance change at I<sub>sat</sub>.



Part Number	STANDARD VALUES - CASE SIZE 31 (10.0 x 12.7 x 5.0mm)					
	Inductance Value (µH)	SRF (Typical) MHz	DC Resistance (Ω)	DC Current Irms (Amps)	DC Current Isat (Amps)	Test Frequency
NPIS31R1R0MTRF	1.0 ± 20%	130	0.021	5.00	5.6	100KHz
NPIS31R1R5MTRF	1.5 ± 20%	110	0.022	4.50	5.2	
NPIS31R2R2MTRF	2.2 ± 20%	90	0.027	3.10	5.0	
NPIS31R3R0MTRF	3.0 ± 20%	65	0.030	2.90	3.9	
NPIS31R4R7MTRF	4.7 ± 20%	50	0.040	2.50	3.2	
NPIS31R6R8MTRF	6.8 ± 20%	30	0.055	2.20	2.8	
NPIS31R100MTRF	10 ± 22%	28	0.065	2.00	2.4	
NPIS31R120MTRF	12 ± 22%	25	0.080	1.80	2.2	
NPIS31R150MTRF	15 ± 22%	20	0.085	1.70	2.0	
NPIS31R180LTRF	18 ± 15%	19	0.090	1.60	1.8	
NPIS31R220LTRF	22 ± 15%	18	0.100	1.40	1.6	
NPIS31R270LTRF	27 ± 15%	16	0.120	1.30	1.5	
NPIS31R330LTRF	33 ± 15%	14	0.160	1.20	1.4	
NPIS31R390LTRF	39 ± 15%	12	0.180	1.05	1.2	
NPIS31R470LTRF	47 ± 15%	11	0.190	1.00	1.0	
NPIS31R560LTRF	56 ± 15%	10	0.210	0.90	0.95	
NPIS31R680LTRF	68 ± 15%	9.0	0.340	0.82	0.90	
NPIS31R820LTRF	82 ± 15%	8.0	0.380	0.75	0.85	
NPIS31R101KTRF	100 ± 10%	7.5	0.420	0.68	0.80	
NPIS31R121KTRF	120 ± 10%	7.0	0.460	0.60	0.70	
NPIS31R151KTRF	150 ± 10%	6.3	0.520	0.55	0.60	
NPIS31R181KTRF	180 ± 10%	5.5	0.700	0.50	0.65	
NPIS31R221KTRF	220 ± 10%	5.0	0.800	0.45	0.50	
NPIS31R271KTRF	270 ± 10%	4.5	1.10	0.40	0.45	
NPIS31R331KTRF	330 ± 10%	4.0	1.20	0.35	0.40	
NPIS31R391KTRF	390 ± 10%	3.3	1.40	0.33	0.35	

Maximum +40°C temperature rise at Irms. Typical -10% inductance change at Isat.

Part Number	STANDARD VALUES - CASE SIZE 52 (15.0 x 18.4 x 7.0mm)					
	Inductance Value (µH)	SRF (Typical) MHz	DC Resistance (Ω)	DC Current Irms (Amps)	DC Current Isat (Amps)	Test Frequency
NPIS52R100MTRF	10 ± 20%	20	0.030	4.00	7.0	100KHz
NPIS52R150MTRF	15 ± 20%	17	0.035	3.60	6.2	
NPIS52R220MTRF	22 ± 20%	15	0.045	3.15	5.0	
NPIS52R330MTRF	33 ± 20%	10	0.060	2.80	4.2	
NPIS52R470MTRF	47 ± 20%	8.5	0.080	2.45	3.5	
NPIS52R680MTRF	68 ± 20%	6.5	0.115	2.00	3.0	
NPIS52R101MTRF	100 ± 20%	5.5	0.180	1.70	2.4	
NPIS52R151MTRF	150 ± 20%	5.0	0.220	1.35	2.0	
NPIS52R221MTRF	220 ± +0%	4.0	0.320	1.15	1.6	
NPIS52R331MTRF	330 ± 20%	3.0	0.500	0.90	1.3	
NPIS52R471MTRF	470 ± 20%	2.5	0.750	0.75	1.1	
NPIS52R681MTRF	680 ± 20%	2.3	1.10	0.65	0.90	
NPIS52R102MTRF	1000 ±20%	1.9	1.50	0.55	0.75	

Maximum +40°C temperature rise at Irms. Typical -10% inductance change at Isat.



Case Size	TAPE DIMENSIONS					
	Ao	Bo	Ko	Co	W	Po
NPIS16R	6.7	4.6	3.2	4.25	12.0	8.0
NPIS22R	11.0	8.5	3.2	11.50	24.0	16.0
NPIS30R	13.2	9.5	3.2	10.25	24.0	12.0
NPIS31R	13.2	9.5	5.4	10.25	24.0	12.0
NPIS52R	18.7	15.4	7.3	14.25	32.0	20.0

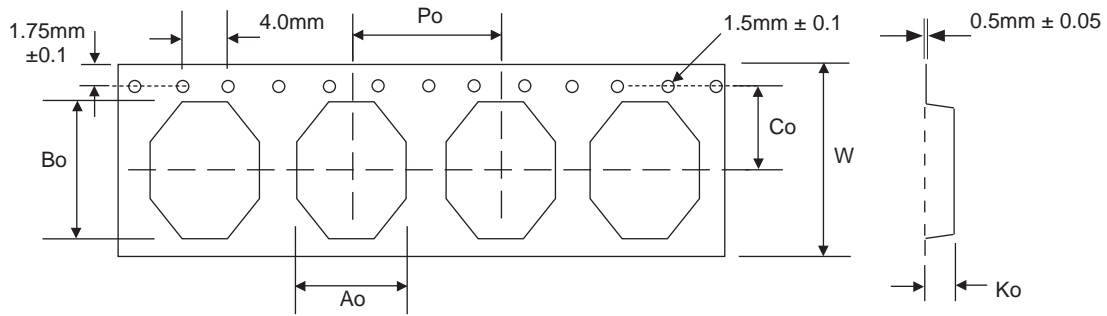

Tape Width	REEL DIMENSIONS (mm)			
	A(mm)	B(mm)	C(mm)	D(mm)
16mm	$16.5 \pm 0.1$	$100 \pm 1$	$13 \pm 0.5$	330
24mm	$24.5 \pm 0.1$			
32mm	$32.5 \pm 0.1$			

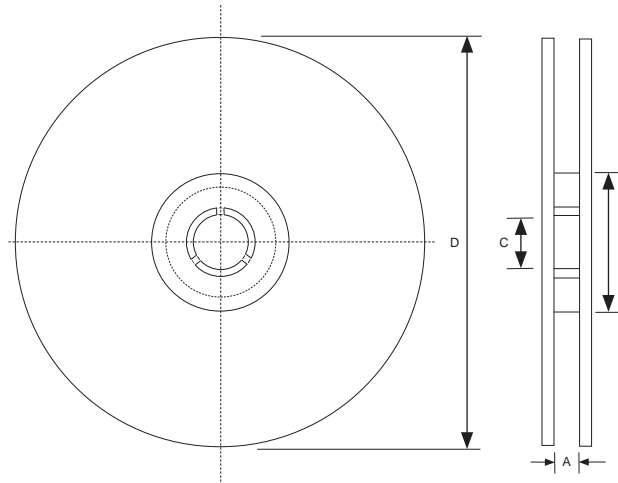

Size	REEL QUANTITY PER CASE SIZE				
	NPIS16R	NPIS22R	NPIS30R	NPIS31R	NPIS52R
Quantity per reel	2500	1000	1000	500	250
Tape Width	16mm	24mm	24mm	24mm	32mm

