

Overview

The KEMET T491 Series, designed specifically for today's highly automated surface mount processes and equipment, is the leading choice for surface mount designs. The T491 combines KEMET's proven solid tantalum technology, acclaimed and respected throughout the world, with the latest in materials, processes and automation, resulting in unsurpassed total performance and value.

This product meets or exceeds the requirements of EIA standard 535BAAC. The physical outline and dimensions of this series conform to this global standard. Five low profile case sizes are available in the T491 Series. The R/2012-12, S/3216-12 and T/3528-12 case sizes have a maximum height of 1.2 mm. The U/6032-15 size has a maximum height of 1.5 mm, and the V/7343-20 has a maximum height of 2.0 mm.

The T491 standard terminations are 100% matte tin and provide excellent wetting characteristics and compatibility with today's surface mount solder systems. Tin/lead (Sn/Pb) terminations are available upon request for any part number. Gold-plated terminations are also available for use with conductive epoxy attachment processes. The symmetrical terminations offer total compliancy to provide the thermal and mechanical stress relief required with today's technology. Lead frame attachments to the tantalum pellet are made via a microprocessor-controlled welding operation, and a high temperature silver epoxy adhesive system.

Standard packaging of these devices is tape and reel in accordance with EIA 481-D. This system provides perfect compatibility with all tape-fed placement units.

Benefits

- Meets or Exceeds EIA Standard 535BAAC
 - Taped and Reeled per EIA 481-D
 - Symmetrical, Compliant Terminations
 - Optical Gold-Plated Terminations
 - Laser-marked Case
 - 100% Surge current test on C, D, E, U, V, X sizes
 - Halogen Free Epoxy
 - Capacitance 0.1 μ F to 1000 μ F
 - Tolerance \pm 10%, \pm 20%
 - Voltage 2.5-50 VDC
 - Extended Range Values
 - Low Profile Case Sizes
 - RoHS Compliance & Lead Free Terminations
- (See www.kemet.com for transition information)
- Operating Temperature: -55°C to +125°C

Applications

Typical applications include decoupling and filtering in industrial and automotive end applications such as DC/DC converters, portable electronics, telecommunications, and control units.



Environmental Compliance

RoHS Compliant (6/6)* according to Directive 2002/95/EC

*When ordered with 100% Sn Solder

SPICE

For a detailed analysis of specific part numbers, please visit kemet.com for a free download of KEMET's SPICE software. The KEMET SPICE program is freeware intended to aid design engineers in analyzing the performance of these capacitors over frequency, temperature, ripple, and DC bias conditions.

Ordering Information

T	491	X	157	K	020	A	T	
Capacitor Class	Series	Case Size	Capacitance Code (pF)	Capacitance Tolerance	Voltage	Failure Rate/Design	Lead Material	Packaging (C-Spec)
T = Tantalum	Industrial	A = 3216-18 B = 3528-21 C = 6032-28 D = 7343-31 E = 7260-38 R = 2012-12 S = 3216-12 T = 3528-12 U = 6032-15 V = 7343-20 X = 7343-43	First two digits represent significant figures. Third digit specifies number of zeros.	K = ±10% M = ±20%	2R5 = 2.5V 003 = 3V 004 = 4V 006 = 6.3V 010 = 10V 016 = 16V 020 = 20V 025 = 25V 035 = 35V 050 = 50V	A = N/A	T = 100% Matte Tin (Sn) Plated* H = Standard Solder Coated (SnPb 5% Pb minimum) G = Gold Plated (A, B, C, D, X only) N = Non-Magnetic 100% Tin (Sn) M = Non-Magnetic (SnPb)	Blank = 7" Reel 7280 = 13" Reel

Performance Characteristics

Item	Performance Characteristics
Operating Temperature	-55°C to 125°C
Rated Capacitance Range	0.1µF–1000µF @ 120 Hz/25°C
Capacitance Tolerance	K Tolerance (10%), M Tolerance (20%)
Rated Voltage Range	2.5V–50V
DF(120Hz)	Refer to Part Number Electrical Specification Table
ESR (100kHz)	Refer to Part Number Electrical Specification Table
Leakage Current	≤ 0.01CV (µA) at Rated Voltage after 5 minutes

Qualification

Test	Condition	Characteristics					
Endurance	85°C @ Rated Voltage, 2,000 Hours 125°C @ 2/3 Rated Voltage, 2,000 Hours	ΔC/C	Within ± 10% of initial value				
		DF	Within initial limits				
		DCL	Within 1.25 x initial limit				
		ESR	Within initial limits				
Storage Life	125°C @ 0 Volts, 2,000 Hours	ΔC/C	Within ± 10% of initial value				
		DF	Within initial limits				
		DCL	Within 1.25 x initial limit				
		ESR	Within initial limits				
Thermal Shock	MIL-Std-202, Method 107, Condition B, mounted, -55°C to 125° C, 1000 cycles	ΔC/C	Within ± 5% of initial value				
		DF	Within initial limits				
		DCL	Within 1.25 x initial limit				
		ESR	Within initial limits				
Temperature Stability	Extreme temperature exposure at a succession of continuous steps at +25°C, -55°C, +25°C, +85°C, +125°C, +25°C.	+25°C	-55°C	+85°C	+125°C		
		ΔC/C	IL*	±10%	±10%	±20%	
		DF	IL	IL	1.5 x IL	1.5 x IL	
		DCL	IL	n/a	10 x IL	12 x IL	
		Surge Voltage	25°C and 85°C, 1.32 x Rated Voltage 1000 cycles (125°C, 1.2 x Rated Voltage).	ΔC/C	Within ± 5% of initial value		
				DF	Within initial limits		
DCL	Within initial limits						
ESR	Within initial limits						
Mechanical Shock/Vibration	MIL-STD-202, Meth. 213, Cond. I, 100G Peak MIL-STD-202, Meth. 204, Cond. D, 10Hz to 2000Hz, 20G Peak	ΔC/C	Within ±10% of initial value				
		DF	Within initial limits				
		DCL	Within initial limits				

*IL = Initial limit

Certification

KEMET's Internal Qualification Plan for this Tantalum series of capacitors follows AEC-Q200 guidelines. Standard catalog part types ordered without a specific automotive designator, i.e., suffix AUTO or four digit customer specific designator (C SPEC), are not considered KEMET Automotive Grade Tantalum capacitors.

Electrical Characteristics

ESR vs. Frequency

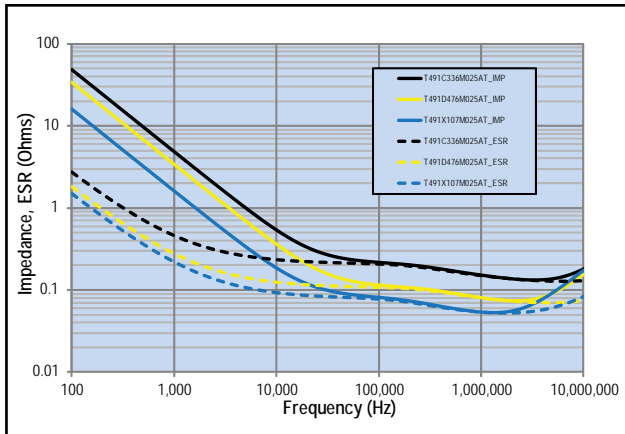

Capacitance vs. Frequency

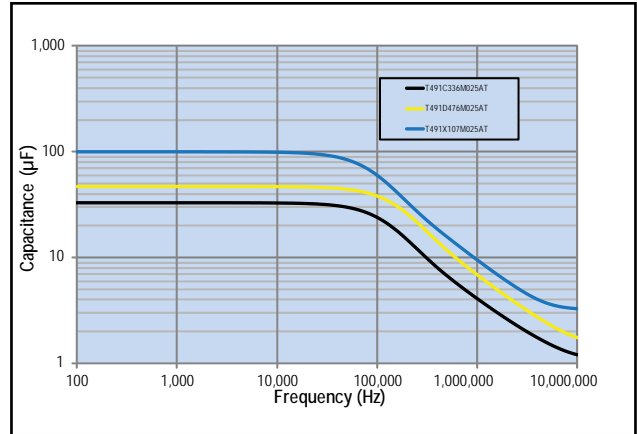

Dimensions – Millimeters (Inches)

Metric will govern

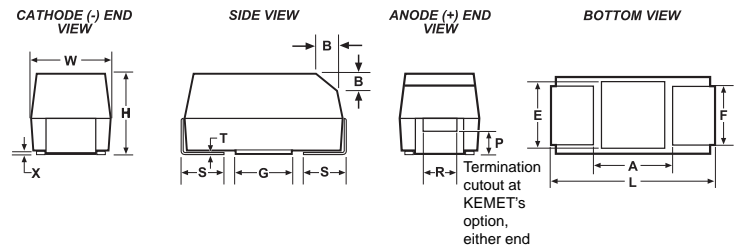

Case Size		Component												
KEMET	EIA	L*	W*	H*	F* ±0.1 ±(.004)	S* ±0.3 ±(.012)	B* ±0.15 (Ref) ±.006	X (Ref)	P (Ref)	R (Ref)	T (Ref)	A (Min)	G (Ref)	E (Ref)
A	3216-18	3.2 ± 0.2 (.126 ± .008)	1.6 ± 0.2 (.063 ± .008)	1.6 ± 0.2 (.063 ± .008)	1.2 (.047)	0.8 (.031)	0.4 (.016)	0.10 ± 0.10 (.004 ± .004)	0.4 (.016)	0.4 (.016)	0.13 (.005)	1.4 (.055)	1.1 (.043)	1.3 (.051)
B	3528-21	3.5 ± 0.2 (.138 ± .008)	2.8 ± 0.2 (.110 ± .008)	1.9 ± 0.2 (.075 ± .008)	2.2 (.087)	0.8 (.031)	0.4 (.016)	0.10 ± 0.10 (.004 ± .004)	0.5 (.020)	1.0 (.039)	0.13 (.005)	2.1 (.083)	1.8 (.071)	2.2 (.087)
C	6032-28	6.0 ± 0.3 (.236 ± .03)	3.2 ± 0.3 (.126 ± .012)	2.5 ± 0.3 (.098 ± .012)	2.2 (.087)	1.3 (.051)	0.5 (.020)	0.10 ± 0.10 (.004 ± .004)	0.9 (.035)	1.0 (.039)	0.13 (.005)	3.1 (.122)	2.8 (.110)	2.4 (.094)
D	7343-31	7.3 ± 0.3 (.287 ± .012)	4.3 ± 0.3 (.169 ± .012)	2.8 ± 0.3 (.110 ± .012)	2.4 (.094)	1.3 (.051)	0.5 (.020)	0.10 ± 0.10 (.004 ± .004)	0.9 (.035)	1.0 (.039)	0.13 (.005)	3.8 (.150)	3.5 (.138)	3.5 (.138)
X	7343-43	7.3 ± 0.3 (.287 ± .012)	4.3 ± 0.3 (.169 ± .012)	4.0 ± 0.3 (.157 ± .012)	2.4 (.094)	1.3 (.051)	0.5 (.020)	0.10 ± 0.10 (.004 ± .004)	1.7 (.067)	1.0 (.039)	0.13 (.005)	3.8 (.150)	3.5 (.138)	3.5 (.138)
E	7260-38	7.3 ± 0.3 (.287 ± .012)	6.0 ± 0.3 (.236 ± .012)	3.6 ± 0.2 (.142 ± .008)	4.1 (.161)	1.3 (.051)	0.5 (.020)	0.10 ± 0.10 (.004 ± .004)	0.9 (.035)	1.0 (.039)	0.13 (.005)	0.13 (.005)	3.5 (.138)	3.5 (.138)
R	2012-12	2.0 ± 0.2 (.079 ± .008)	1.3 ± 0.2 (.051 ± .008)	1.2 (.047)	0.9 (.035)	0.5 (.020)	n/a	0.05 (.002)	n/a	n/a	0.13 (.005)	0.8 (.031)	0.5 (.020)	0.8 (.031)
S	3216-12	3.2 ± 0.2 (.126 ± .008)	1.6 ± 0.2 (.063 ± .008)	1.2 (.047)	1.2 (.047)	0.8 (.031)	n/a	0.05 (.002)	n/a	n/a	0.13 (.005)	1.4 (.055)	1.1 (.043)	1.3 (.051)
T	3528-12	3.5 ± 0.2 (.138 ± .008)	2.8 ± 0.2 (.110 ± .008)	1.2 (.047)	2.2 (.087)	0.8 (.031)	n/a	0.05 (.002)	n/a	n/a	0.13 (.005)	2.1 (.083)	1.8 (.071)	2.2 (.087)
U	6032-15	6.0 ± 0.3 (.236 ± .012)	3.2 ± 0.2 (.110 ± .008)	3.2 ± 0.2	2.2 (.087)	1.3 (.051)	n/a	0.05 (.002)	n/a	n/a	0.13 (.005)	3.1 (.122)	2.8 (.110)	2.4 (.094)
V	7343-20	7.3 ± 0.3 (.287 ± .012)	4.3 ± 0.3 (.169 ± .012)	2.0 (.079)	2.4 (.094)	1.3 (.051)	n/a	0.05 (.002)	n/a	n/a	0.13 (.005)	3.8 (.150)	3.5 (.138)	3.5 (.138)

Notes: (Ref) – Dimensions provided for reference only. No dimensions are provided for B, P or R because low profile cases do not have a bevel or a notch.

* MIL-C-55365/8 specified dimensions

Table 1 – Ratings & Part Number Reference

Rated Voltage	Rated Cap	Case Code/ Case Size	KEMET Part Number	DC Leakage		DF	ESR	Maximum Allowable Ripple Current			Moisture Sensitivity
				μAmps +20°C	+20°C 120Hz			+20°C 100kHz	+25°C 100kHz	+85°C 100kHz	
85°C	120Hz	KEMET/EIA	(See below for part options)	max/5min	% Max	Ohms	mAmps	mAmps	mAmps	Temp≤260°C	
VDC	μF			J-STD-020D							
2.5	100	T/3528-12	T491T107(1)2R5A(2)	2.5	24.0	3.9	134	121	54	1	
2.5	220	D/7343-31	T491D227(1)2R5A(2)	5.5	8.0	0.3	707	636	283	1	
3	33	A/3216-18	T491A336(1)003A(2)	1.0	6.0	4.0	137	123	55	1	
4	3.3	A/3216-18	T491A335(1)004A(2)	0.1	6.0	8.0	97	87	39	1	
4	4.7	A/3216-18	T491A475(1)004A(2)	0.2	6.0	8.0	97	87	39	1	
4	6.8	A/3216-18	T491A685(1)004A(2)	0.3	6.0	6.0	112	101	45	1	
4	6.8	S/3216-12	T491S685(1)004A(2)	0.3	6.0	15.0	63	57	25	1	
4	10	B/3528-21	T491B106(1)004A(2)	0.4	6.0	3.5	156	140	62	1	
4	10	A/3216-18	T491A106(1)004A(2)	0.4	6.0	6.0	112	101	45	1	
4	10	S/3216-12	T491S106(1)004A(2)	0.4	6.0	15.0	63	57	25	1	
4	10	R/2012-12	T491R106(1)004A(2)	0.4	8.0	10.0	50	45	20	1	
4	15	B/3528-21	T491B156(1)004A(2)	0.6	6.0	3.5	156	140	62	1	
4	15	A/3216-18	T491A156(1)004A(2)	0.6	6.0	4.0	137	123	55	1	
4	15	T/3528-12	T491T156(1)004A(2)	0.6	6.0	5.0	118	106	47	1	
4	15	S/3216-12	T491S156(1)004A(2)	0.6	10.0	15.0	63	57	25	1	
4	22	C/6032-28	T491C226(1)004A(2)	0.9	6.0	1.8	247	222	99	1	
4	22	B/3528-21	T491B226(1)004A(2)	0.9	6.0	3.5	156	140	62	1	
4	22	A/3216-18	T491A226(1)004A(2)	0.9	6.0	4.0	137	123	55	1	
4	22	T/3528-12	T491T226(1)004A(2)	0.9	6.0	5.0	118	106	47	1	
4	22	S/3216-12	T491S226(1)004A(2)	0.9	10.0	10.0	77	69	31	1	
4	33	C/6032-28	T491C336(1)004A(2)	1.3	6.0	1.8	247	222	99	1	
4	33	U/6032-15	T491U336(1)004A(2)	1.3	6.0	1.8	224	202	90	1	
4	33	B/3528-21	T491B336(1)004A(2)	1.3	6.0	3.5	156	140	62	1	
4	33	A/3216-18	T491A336(1)004A(2)	1.3	6.0	4.0	137	123	55	1	
4	33	T/3528-12	T491T336(1)004A(2)	1.3	8.0	5.0	118	106	47	1	
4	47	C/6032-28	T491C476(1)004A(2)	1.9	6.0	1.8	247	222	99	1	
4	47	U/6032-15	T491U476(1)004A(2)	1.9	6.0	1.8	224	202	90	1	
4	47	B/3528-21	T491B476(1)004A(2)	1.9	6.0	3.0	168	151	67	1	
4	47	A/3216-18	T491A476(M)004A(2)	1.9	12.0	2.5	173	156	69	1	
4	47	T/3528-12	T491T476(M)004A(2)	1.9	12.0	6.0	108	97	43	1	
4	68	D/7343-31	T491D686(1)004A(2)	2.7	6.0	0.8	433	390	173	1	
4	68	C/6032-28	T491C686(1)004A(2)	2.7	6.0	1.6	262	236	105	1	
4	68	U/6032-15	T491U686(1)004A(2)	2.7	6.0	1.8	224	202	90	1	
4	68	B/3528-21	T491B686(1)004A(2)	2.7	6.0	3.5	156	140	62	1	
4	68	A/3216-18	T491A686(1)004A(2)	2.7	30.0	4.0	137	123	55	1	
4	100	D/7343-31	T491D107(1)004A(2)	4.0	8.0	0.8	433	390	173	1	
4	100	C/6032-28	T491C107(1)004A(2)	4.0	8.0	1.2	303	273	121	1	
4	100	U/6032-15	T491U107(1)004A(2)	4.0	10.0	1.8	224	202	90	1	
4	100	B/3528-21	T491B107(M)004A(2)	4.0	8.0	0.9	307	276	123	1	
4	100	A/3216-18	T491A107(M)004A(2)	4.0	30.0	4.0	137	123	55	1	
4	100	T/3528-12	T491T107(M)004A(2)	4.0	30.0	5.0	118	106	47	1	
4	150	D/7343-31	T491D157(1)004A(2)	6.0	8.0	0.8	433	390	173	1	
4	150	U/6032-15	T491U157(1)004AT	6.0	8.0	1.3	263	237	105	1	
4	150	V/7343-20	T491V157(1)004A(2)	6.0	8.0	0.7	423	381	169	1	
4	150	C/6032-28	T491C157(1)004A(2)	6.0	8.0	1.2	303	273	121	1	
4	150	B/3528-21	T491B157(M)004A(2)	6.0	12.0	2.0	206	185	82	1	
VDC	μF	KEMET/EIA	(See below for part options)	max/5min	% Max	Ohms	mAmps	mAmps	mAmps	J-STD-020D	
85°C	120Hz			μAmps +20°C	+20°C 120Hz	+20°C 100kHz	+25°C 100kHz	+85°C 100kHz	+125°C 100kHz	Temp≤260°C	
Rated Voltage	Rated Cap	Case Code/ Case Size	KEMET Part Number	DC Leakage	DF	ESR	Maximum Allowable Ripple Current			Moisture Sensitivity	

1) To complete KEMET part number, insert M for ± 20% or K for ± 10%. Designates Capacitance tolerance.

2) To complete KEMET part number, insert T = 100% Matte Tin (Sn) Plated, G = Gold Plated, H = Standard Solder coated (SnPb 5% Pb minimum). Designates Termination Finish.

Refer to Ordering Information for additional detail.

Higher voltage ratings and tighter tolerance product including ESR may be substituted within the same size at KEMET's option. Voltage substitution will be marked with the higher voltage rating. Substitutions can include better than series.

Table 1 – Ratings & Part Number Reference con't

Rated Voltage	Rated Cap	Case Code/ Case Size	KEMET Part Number	DC Leakage		DF	ESR	Maximum Allowable Ripple Current			Moisture Sensitivity
				μAmps +20°C	+20°C 120Hz			+20°C 100kHz	+25°C 100kHz	+85°C 100kHz	
VDC	μF	KEMET/EIA	(See below for part options)	max/5min	% Max	Ohms	mAmps	mAmps	mAmps	J-STD-020D	
4	220	V/7343-20	T491V227(1)004A(2)	8.8	8.0	0.7	423	381	169	1	
4	220	B/3528-21	T491B227(M)004A(2)	8.8	18.0	0.5	412	371	165	1	
4	220	C/6032-28	T491C227(1)004AT	8.8	15.0	1.2	303	273	121	1	
4	220	D/7343-31	T491D227(1)004AT	8.8	8.0	0.8	433	390	173	1	
4	220	W/7343-15	T491W227(1)004AT	8.8	8.0	0.8	474	427	190	1	
4	330	D/7343-31	T491D337(1)004A(2)	13.2	8.0	0.7	463	417	185	1	
4	330	V/7343-20	T491V337(1)004A(2)	13.2	12.0	0.7	423	381	169	1	
4	330	C/6032-28	T491C337(1)004A(2)	13.2	10.0	0.9	350	315	140	1	
4	330	X/7343-43	T491X337(1)004AT	13.2	8.0	0.8	454	409	182	1	
4	470	X/7343-43	T491X477(1)004A(2)	18.8	8.0	0.5	574	517	230	1	
4	470	D/7343-31	T491D477(1)004A(2)	18.8	8.0	0.8	433	390	173	1	
4	680	X/7343-43	T491X687(1)004A(2)	27.2	12.0	0.5	574	517	230	1	
4	680	D/7343-31	T491D687(1)004A(2)	27.2	12.0	0.5	548	493	219	1	
4	1000	X/7343-43	T491X108(1)004A(2)	40.0	12.0	0.5	574	517	230	1	
4	1000	E/7260-38	T491E108(M)004A(2)	40.0	15.0	0.2	1000	900	400	1	
6.3	2.2	R/2012-12	T491R225(1)006A(2)	0.1	6.0	25.0	32	29	13	1	
6.3	2.2	A/3216-18	T491A225(1)006A(2)	0.1	6.0	8.0	97	87	39	1	
6.3	3.3	A/3216-18	T491A335(1)006A(2)	0.2	6.0	8.0	97	87	39	1	
6.3	4.7	A/3216-18	T491A475(1)006A(2)	0.3	6.0	6.0	112	101	45	1	
6.3	4.7	S/3216-12	T491S475(1)006A(2)	0.3	6.0	15.0	63	57	25	1	
6.3	6.8	B/3528-21	T491B685(1)006A(2)	0.4	6.0	3.5	156	140	62	1	
6.3	6.8	A/3216-18	T491A685(1)006A(2)	0.4	6.0	6.0	112	101	45	1	
6.3	6.8	S/3216-12	T491S685(1)006A(2)	0.4	6.0	15.0	63	57	25	1	
6.3	6.8	R/2012-12	T491R685(1)006A(2)	0.4	8.0	15.0	41	37	16	1	
6.3	10	B/3528-21	T491B106(1)006A(2)	0.6	6.0	3.5	156	140	62	1	
6.3	10	A/3216-18	T491A106(1)006A(2)	0.6	6.0	4.0	137	123	55	1	
6.3	10	T/3528-12	T491T106(1)006A(2)	0.6	6.0	5.0	118	106	47	1	
6.3	10	S/3216-12	T491S106(1)006A(2)	0.6	10.0	15.0	63	57	25	1	
6.3	10	R/2012-12	T491R106(1)006A(2)	0.6	8.0	10.0	50	45	20	1	
6.3	15	C/6032-28	T491C156(1)006A(2)	0.9	6.0	1.8	247	222	99	1	
6.3	15	B/3528-21	T491B156(1)006A(2)	0.9	6.0	3.5	156	140	62	1	
6.3	15	A/3216-18	T491A156(1)006A(2)	0.9	6.0	3.5	146	131	58	1	
6.3	15	T/3528-12	T491T156(1)006A(2)	0.9	6.0	5.0	118	106	47	1	
6.3	15	S/3216-12	T491S156(1)006A(2)	0.9	15.0	10.0	77	69	31	1	
6.3	22	C/6032-28	T491C226(1)006A(2)	1.4	6.0	1.8	247	222	99	1	
6.3	22	U/6032-15	T491U226(1)006A(2)	1.4	6.0	1.8	224	202	90	1	
6.3	22	B/3528-21	T491B226(1)006A(2)	1.4	6.0	3.5	156	140	62	1	
6.3	22	A/3216-18	T491A226(1)006A(2)	1.4	6.0	4.0	137	123	55	1	
6.3	22	T/3528-12	T491T226(1)006A(2)	1.4	8.0	5.0	118	106	47	1	
6.3	33	C/6032-28	T491C336(1)006A(2)	2.1	6.0	1.8	247	222	99	1	
6.3	33	U/6032-15	T491U336(1)006A(2)	2.1	6.0	1.8	224	202	90	1	
6.3	33	B/3528-21	T491B336(1)006A(2)	2.1	6.0	3.0	168	151	67	1	
6.3	33	A/3216-18	T491A336(1)006A(2)	2.1	12.0	2.5	173	156	69	1	
6.3	33	T/3528-12	T491T336(1)006A(2)	2.1	12.0	6.0	108	97	43	1	
6.3	47	D/7343-31	T491D476(1)006A(2)	3.0	6.0	0.8	433	390	173	1	
6.3	47	C/6032-28	T491C476(1)006A(2)	3.0	6.0	1.6	262	236	105	1	
6.3	47	U/6032-15	T491U476(1)006A(2)	3.0	6.0	1.8	224	202	90	1	
VDC	μF	KEMET/EIA	(See below for part options)	max/5min	% Max	Ohms	mAmps	mAmps	mAmps	J-STD-020D	
85°C	120Hz			μAmps +20°C	+20°C 120Hz	+20°C 100kHz	+25°C 100kHz	+85°C 100kHz	+125°C 100kHz	Temp≤260°C	
Rated Voltage	Rated Cap	Case Code/ Case Size	KEMET Part Number	DC Leakage	DF	ESR	Maximum Allowable Ripple Current			Moisture Sensitivity	

1) To complete KEMET part number, insert M for ± 20% or K for ± 10%. Designates Capacitance tolerance.

2) To complete KEMET part number, insert T = 100% Matte Tin (Sn) Plated, G = Gold Plated, H = Standard Solder coated (SnPb 5% Pb minimum). Designates Termination Finish.

Refer to Ordering Information for additional detail.

Higher voltage ratings and tighter tolerance product including ESR may be substituted within the same size at KEMET's option. Voltage substitution will be marked with the higher voltage rating. Substitutions can include better than series.

Table 1 – Ratings & Part Number Reference con't

Rated Voltage	Rated Cap	Case Code/ Case Size	KEMET Part Number	DC Leakage		DF	ESR	Maximum Allowable Ripple Current			Moisture Sensitivity
				μAmps +20°C	+20°C 120Hz			+20°C 100kHz	+25°C 100kHz	+85°C 100kHz	
85°C	120Hz	KEMET/EIA	(See below for part options)	max/5min	% Max	Ohms	mAmps	mAmps	mAmps	Temp≤260°C	
VDC	μF			J-STD-020D							
6.3	47	V/7343-20	T491V476(1)006AT	3.0	6.0	0.7	423	381	169	1	
6.3	47	B/3528-21	T491B476(1)006A(2)	3.0	6.0	2.0	206	185	82	1	
6.3	47	A/3216-18	T491A476(M)006A(2)	3.0	12.0	3.5	146	131	58	1	
6.3	47	T/3528-12	T491T476(1)006A(2)	3.0	24.0	4.4	126	113	50	1	
6.3	68	D/7343-31	T491D686(1)006A(2)	4.3	6.0	0.8	433	390	173	1	
6.3	68	C/6032-28	T491C686(1)006A(2)	4.3	6.0	1.2	303	273	121	1	
6.3	68	U/6032-15	T491U686(1)006A(2)	4.3	10.0	1.8	224	202	90	1	
6.3	68	V/7343-20	T491V686(1)006AT	4.3	6.0	0.7	423	381	169	1	
6.3	68	B/3528-21	T491B686(1)006A(2)	4.3	8.0	0.9	307	276	123	1	
6.3	68	A/3216-18	T491A686(1)006A(2)	4.3	30.0	4.0	137	123	55	1	
6.3	100	D/7343-31	T491D107(1)006A(2)	6.3	8.0	0.8	433	390	173	1	
6.3	100	V/7343-20	T491V107(1)006A(2)	6.3	8.0	0.7	423	381	169	1	
6.3	100	C/6032-28	T491C107(1)006A(2)	6.3	8.0	0.9	350	315	140	1	
6.3	100	M/3528-15	T491M107(1)006AT	6.3	20.0	1.0	346	311	138	1	
6.3	100	U/6032-15	T491U107(1)006A(2)	6.3	10.0	1.8	224	202	90	1	
6.3	100	B/3528-21	T491B107(1)006A(2)	6.3	15.0	3.0	168	151	67	1	
6.3	150	D/7343-31	T491D157(1)006A(2)	9.5	8.0	0.7	463	417	185	1	
6.3	150	C/6032-28	T491C157(1)006A(2)	9.5	8.0	1.2	303	273	121	1	
6.3	150	V/7343-20	T491V157(1)006A(2)	9.5	8.0	0.7	423	381	169	1	
6.3	150	U/6032-15	T491U157(1)006AT	9.5	8.0	0.6	387	348	155	1	
6.3	150	W/7343-15	T491W157(1)006AT	9.5	8.0	0.8	474	427	190	1	
6.3	220	X/7343-43	T491X227(1)006A(2)	13.9	8.0	0.7	486	437	194	1	
6.3	220	D/7343-31	T491D227(1)006A(2)	13.9	8.0	0.7	463	417	185	1	
6.3	220	C/6032-28	T491C227(M)006A(2)	13.9	10.0	1.2	303	273	121	1	
6.3	220	V/7343-20	T491V227(1)006A(2)	13.9	12.0	0.7	423	381	169	1	
6.3	220	W/7343-15	T491W227(1)006AT	13.9	8.0	0.8	474	427	190	1	
6.3	330	V/7343-20	T491V337(1)006AT	20.8	8.0	0.7	423	381	169	1	
6.3	330	X/7343-43	T491X337(1)006A(2)	20.8	8.0	0.4	642	578	257	1	
6.3	330	D/7343-31	T491D337(1)006A(2)	20.8	8.0	0.4	612	551	245	1	
6.3	330	E/7260-38	T491E337(1)006A(2)	20.8	8.0	0.5	632	569	253	1	
6.3	470	X/7343-43	T491X477(1)006A(2)	29.6	10.0	0.4	642	578	257	1	
6.3	470	D/7343-31	T491D477(M)006A(2)	29.6	12.0	0.4	612	551	245	1	
6.3	470	E/7260-38	T491E477(1)006A(2)	29.6	10.0	0.4	707	636	283	1	
6.3	680	X/7343-43	T491X687(1)006A(2)	42.8	15.0	0.6	524	472	210	1	
6.3	680	E/7260-38	T491E687(M)006A(2)	42.8	12.0	0.5	632	569	253	1	
6.3	1000	X/7343-43	T491X108(1)006AT	63.0	15.0	0.6	524	472	210	1	
10	1.5	A/3216-18	T491A155(1)010A(2)	0.2	6.0	8.0	97	87	39	1	
10	2.2	B/3528-21	T491B225(1)010A(2)	0.2	6.0	3.5	156	140	62	1	
10	2.2	A/3216-18	T491A225(1)010A(2)	0.2	6.0	8.0	97	87	39	1	
10	3.3	A/3216-18	T491A335(1)010A(2)	0.3	6.0	6.0	112	101	45	1	
10	3.3	S/3216-12	T491S335(1)010A(2)	0.3	6.0	15.0	63	57	25	1	
10	3.3	R/2012-12	T491R335(1)010A(2)	0.3	8.0	15.0	41	37	16	1	
10	4.7	B/3528-21	T491B475(1)010A(2)	0.5	6.0	3.5	156	140	62	1	
10	4.7	A/3216-18	T491A475(1)010A(2)	0.5	6.0	5.0	122	110	49	1	
10	4.7	S/3216-12	T491S475(1)010A(2)	0.5	6.0	15.0	63	57	25	1	
10	4.7	R/2012-12	T491R475(1)010A(2)	0.5	8.0	10.0	50	45	20	1	
10	6.8	B/3528-21	T491B685(1)010A(2)	0.7	6.0	3.5	156	140	62	1	
VDC	μF	KEMET/EIA	(See below for part options)	max/5min	% Max	Ohms	mAmps	mAmps	mAmps	J-STD-020D	
85°C	120Hz			μAmps +20°C	+20°C 120Hz	+20°C 100kHz	+25°C 100kHz	+85°C 100kHz	+125°C 100kHz	Temp≤260°C	
Rated Voltage	Rated Cap	Case Code/ Case Size	KEMET Part Number	DC Leakage	DF	ESR	Maximum Allowable Ripple Current			Moisture Sensitivity	

1) To complete KEMET part number, insert M for ± 20% or K for ± 10%. Designates Capacitance tolerance.

2) To complete KEMET part number, insert T = 100% Matte Tin (Sn) Plated, G = Gold Plated, H = Standard Solder coated (SnPb 5% Pb minimum). Designates Termination Finish.

Refer to Ordering Information for additional detail.

Higher voltage ratings and tighter tolerance product including ESR may be substituted within the same size at KEMET's option. Voltage substitution will be marked with the higher voltage rating. Substitutions can include better than series.

Table 1 – Ratings & Part Number Reference con't

Rated Voltage	Rated Cap	Case Code/ Case Size	KEMET Part Number	DC Leakage			ESR	Maximum Allowable Ripple Current			Moisture Sensitivity
				μAmps +20°C	+20°C 120Hz	+20°C 100kHz		+25°C 100kHz	+85°C 100kHz	+125°C 100kHz	
85°C	120Hz	KEMET/EIA	(See below for part options)	max/5min	% Max	Ohms	mAmps	mAmps	mAmps	Temp≤260°C	
VDC	μF			J-STD-020D							
10	6.8	A/3216-18	T491A685(1)010A(2)	0.7	6.0	4.0	137	123	55	1	
10	6.8	T/3528-12	T491T685(1)010A(2)	0.7	6.0	5.0	118	106	47	1	
10	6.8	S/3216-12	T491S685(1)010A(2)	0.7	10.0	15.0	63	57	25	1	
10	10	C/6032-28	T491C106(1)010A(2)	1.0	6.0	1.8	247	222	99	1	
10	10	B/3528-21	T491B106(1)010A(2)	1.0	6.0	3.5	156	140	62	1	
10	10	A/3216-18	T491A106(1)010A(2)	1.0	6.0	4.0	137	123	55	1	
10	10	T/3528-12	T491T106(1)010A(2)	1.0	6.0	5.0	118	106	47	1	
10	10	S/3216-12	T491S106(1)010A(2)	1.0	10.0	15.0	63	57	25	1	
10	10	R/2012-12	T491R106(1)010A(2)	1.0	24.0	30.0	29	26	12	1	
10	15	C/6032-28	T491C156(1)010A(2)	1.5	6.0	1.8	247	222	99	1	
10	15	U/6032-15	T491U156(1)010A(2)	1.5	6.0	1.8	224	202	90	1	
10	15	B/3528-21	T491B156(1)010A(2)	1.5	6.0	2.8	174	157	70	1	
10	15	A/3216-18	T491A156(1)010A(2)	1.5	8.0	6.0	112	101	45	1	
10	15	T/3528-12	T491T156(1)010A(2)	1.5	8.0	5.0	118	106	47	1	
10	22	C/6032-28	T491C226(1)010A(2)	2.2	6.0	1.8	247	222	99	1	
10	22	U/6032-15	T491U226(1)010A(2)	2.2	6.0	1.8	224	202	90	1	
10	22	B/3528-21	T491B226(1)010A(2)	2.2	6.0	2.4	188	169	75	1	
10	22	A/3216-18	T491A226(M)010A(2)	2.2	10.0	6.0	112	101	45	1	
10	22	T/3528-12	T491T226(1)010A(2)	2.2	12.0	8.0	94	85	38	1	
10	33	D/7343-31	T491D336(1)010A(2)	3.3	6.0	0.8	433	390	173	1	
10	33	V/7343-20	T491V336(1)010A(2)	3.3	6.0	0.7	423	381	169	1	
10	33	C/6032-28	T491C336(1)010A(2)	3.3	6.0	1.6	262	236	105	1	
10	33	U/6032-15	T491U336(1)010A(2)	3.3	6.0	1.8	224	202	90	1	
10	33	B/3528-21	T491B336(1)010A(2)	3.3	6.0	1.8	217	195	87	1	
10	33	T/3528-12	T491T336(1)010A(2)	3.3	24.0	5.0	118	106	47	1	
10	33	A/3216-18	T491A336(1)010A(2)	3.3	15.0	6.0	112	101	45	1	
10	47	D/7343-31	T491D476(1)010A(2)	4.7	6.0	0.8	433	390	173	1	
10	47	V/7343-20	T491V476(1)010A(2)	4.7	6.0	0.7	423	381	169	1	
10	47	C/6032-28	T491C476(1)010A(2)	4.7	6.0	1.2	303	273	121	1	
10	47	U/6032-15	T491U476(1)010A(2)	4.7	10.0	2.2	202	182	81	1	
10	47	B/3528-21	T491B476(1)010A(2)	4.7	8.0	1.0	292	263	117	1	
10	68	D/7343-31	T491D686(1)010A(2)	6.8	6.0	0.8	433	390	173	1	
10	68	V/7343-20	T491V686(1)010A(2)	6.8	6.0	0.7	423	381	169	1	
10	68	C/6032-28	T491C686(1)010A(2)	6.8	6.0	1.2	303	273	121	1	
10	68	W/7343-15	T491W686(1)010AT	6.8	6.0	1.2	387	348	155	1	
10	68	U/6032-15	T491U686(1)010A(2)	6.8	10.0	1.8	224	202	90	1	
10	68	B/3528-21	T491B686(M)010A(2)	6.8	10.0	3.0	168	151	67	1	
10	100	D/7343-31	T491D107(1)010A(2)	10.0	8.0	0.7	463	417	185	1	
10	100	U/6032-15	T491U107(1)010AT	10.0	8.0	0.7	359	323	144	1	
10	100	W/7343-15	T491W107(1)010AT	10.0	8.0	0.8	474	427	190	1	
10	100	C/6032-28	T491C107(1)010A(2)	10.0	8.0	1.2	303	273	121	1	
10	100	V/7343-20	T491V107(1)010A(2)	10.0	8.0	0.7	423	381	169	1	
10	150	X/7343-43	T491X157(1)010A(2)	15.0	8.0	0.7	486	437	194	1	
10	150	D/7343-31	T491D157(1)010A(2)	15.0	8.0	0.7	463	417	185	1	
10	150	C/6032-28	T491C157(1)010A(2)	15.0	10.0	0.9	350	315	140	1	
10	150	V/7343-20	T491V157(1)010A(2)	15.0	8.0	0.7	423	381	169	1	
10	220	X/7343-43	T491X227(1)010A(2)	22.0	8.0	0.5	574	517	230	1	
10	220	D/7343-31	T491D227(1)010A(2)	22.0	8.0	0.5	548	493	219	1	
VDC	μF	KEMET/EIA	(See below for part options)	max/5min	% Max	Ohms	mAmps	mAmps	mAmps	J-STD-020D	
85°C	120Hz			μAmps +20°C	+20°C 120Hz	+20°C 100kHz	+25°C 100kHz	+85°C 100kHz	+125°C 100kHz	Temp≤260°C	
Rated Voltage	Rated Cap	Case Code/ Case Size	KEMET Part Number	DC Leakage	DF	ESR	Maximum Allowable Ripple Current			Moisture Sensitivity	

1) To complete KEMET part number, insert M for ± 20% or K for ± 10%. Designates Capacitance tolerance.

2) To complete KEMET part number, insert T = 100% Matte Tin (Sn) Plated, G = Gold Plated, H = Standard Solder coated (SnPb 5% Pb minimum). Designates Termination Finish.

Refer to Ordering Information for additional detail.

Higher voltage ratings and tighter tolerance product including ESR may be substituted within the same size at KEMET's option. Voltage substitution will be marked with the higher voltage rating. Substitutions can include better than series.

Table 1 – Ratings & Part Number Reference con't

Rated Voltage	Rated Cap	Case Code/ Case Size	KEMET Part Number	DC Leakage		DF	ESR	Maximum Allowable Ripple Current			Moisture Sensitivity
				μAmps +20°C	+20°C 120Hz			+20°C 100kHz	+25°C 100kHz	+85°C 100kHz	
85°C	120Hz	KEMET/EIA	(See below for part options)	max/5min	% Max	Ohms	mAmps	mAmps	mAmps	Temp≤260°C	
VDC	μF			J-STD-020D							
10	330	D/7343-31	T491D337(M)010A(2)	33.0	10.0	0.5	548	493	219	1	
10	330	X/7343-43	T491X337(1)010A(2)	33.0	10.0	0.5	574	517	230	1	
10	330	E/7260-38	T491E337(1)010A(2)	33.0	10.0	0.5	632	569	253	1	
10	470	X/7343-43	T491X477(M)010A(2)	47.0	10.0	0.2	908	817	363	1	
10	470	E/7260-38	T491E477(M)010A(2)	47.0	12.0	0.5	632	569	253	1	
16	1	A/3216-18	T491A105(1)016A(2)	0.2	4.0	10.0	87	78	35	1	
16	1.5	A/3216-18	T491A155(1)016A(2)	0.2	6.0	8.0	97	87	39	1	
16	2.2	A/3216-18	T491A225(1)016A(2)	0.4	6.0	6.0	112	101	45	1	
16	2.2	S/3216-12	T491S225(1)016A(2)	0.4	6.0	15.0	63	57	25	1	
16	2.2	R/2012-12	T491R225(1)016A(2)	0.4	8.0	25.0	32	29	13	1	
16	3.3	B/3528-21	T491B335(1)016A(2)	0.5	6.0	3.5	156	140	62	1	
16	3.3	A/3216-18	T491A335(1)016A(2)	0.5	6.0	5.0	122	110	49	1	
16	4.7	C/6032-28	T491C475(1)016A(2)	0.8	6.0	2.4	214	193	86	1	
16	4.7	B/3528-21	T491B475(1)016A(2)	0.8	6.0	3.5	156	140	62	1	
16	4.7	A/3216-18	T491A475(1)016A(2)	0.8	6.0	4.0	137	123	55	1	
16	4.7	T/3528-12	T491T475(1)016A(2)	0.8	6.0	5.0	118	106	47	1	
16	6.8	C/6032-28	T491C685(1)016A(2)	1.1	6.0	1.9	241	217	96	1	
16	6.8	B/3528-21	T491B685(1)016A(2)	1.1	6.0	2.5	184	166	74	1	
16	6.8	A/3216-18	T491A685(1)016A(2)	1.1	6.0	3.5	146	131	58	1	
16	10	C/6032-28	T491C106(1)016A(2)	1.6	6.0	1.8	247	222	99	1	
16	10	U/6032-15	T491U106(1)016A(2)	1.6	6.0	1.8	224	202	90	1	
16	10	B/3528-21	T491B106(1)016A(2)	1.6	6.0	2.8	174	157	70	1	
16	10	A/3216-18	T491A106(1)016A(2)	1.6	8.0	7.0	104	94	42	1	
16	10	T/3528-12	T491T106(1)016A(2)	1.6	8.0	8.0	94	85	38	1	
16	15	C/6032-28	T491C156(1)016A(2)	2.4	6.0	1.8	247	222	99	1	
16	15	U/6032-15	T491U156(1)016A(2)	2.4	6.0	1.8	224	202	90	1	
16	15	B/3528-21	T491B156(1)016A(2)	2.4	6.0	2.5	184	166	74	1	
16	15	A/3216-18	T491A156(1)016A(2)	2.4	8.0	3.5	146	131	58	1	
16	22	D/7343-31	T491D226(1)016A(2)	3.5	6.0	0.8	433	390	173	1	
16	22	C/6032-28	T491C226(1)016A(2)	3.5	6.0	1.6	262	236	105	1	
16	22	U/6032-15	T491U226(1)016A(2)	3.5	10.0	3.0	173	156	69	1	
16	22	B/3528-21	T491B226(1)016A(2)	3.5	6.0	2.2	197	177	79	1	
16	33	D/7343-31	T491D336(1)016A(2)	5.3	6.0	0.8	433	390	173	1	
16	33	C/6032-28	T491C336(1)016A(2)	5.3	6.0	1.2	303	273	121	1	
16	33	U/6032-15	T491U336(1)016A(2)	5.3	12.0	3.0	173	156	69	1	
16	33	B/3528-21	T491B336(1)016A(2)	5.3	8.0	2.1	201	181	80	1	
16	47	D/7343-31	T491D476(1)016A(2)	7.5	6.0	0.8	433	390	173	1	
16	47	V/7343-20	T491V476(1)016A(2)	7.5	6.0	0.7	423	381	169	1	
16	47	C/6032-28	T491C476(1)016A(2)	7.5	6.0	1.2	303	273	121	1	
16	68	V/7343-20	T491V686(1)016A(2)	10.9	6.0	0.7	423	381	169	1	
16	68	C/6032-28	T491C686(1)016AT	10.9	6.0	1.2	303	273	121	1	
16	68	W/7343-15	T491W686(1)016AT	10.9	6.0	0.8	474	427	190	1	
16	68	D/7343-31	T491D686(1)016A(2)	10.9	6.0	0.7	463	417	185	1	
16	68	C/6032-28	T491C686(1)016A(2)	10.9	12.0	1.2	303	273	121	1	
16	100	X/7343-43	T491X107(1)016A(2)	16.0	8.0	0.7	486	437	194	1	
16	100	C/6032-28	T491C107(1)016AT	16.0	10.0	1.0	332	299	133	1	
16	100	V/7343-20	T491V107(1)016A(2)	16.0	12.0	0.7	423	381	169	1	
VDC	μF	KEMET/EIA	(See below for part options)	max/5min	% Max	Ohms	mAmps	mAmps	mAmps	J-STD-020D	
85°C	120Hz			μAmps +20°C	+20°C 120Hz	+20°C 100kHz	+25°C 100kHz	+85°C 100kHz	+125°C 100kHz	Temp≤260°C	
Rated Voltage	Rated Cap	Case Code/ Case Size	KEMET Part Number	DC Leakage	DF	ESR	Maximum Allowable Ripple Current			Moisture Sensitivity	

1) To complete KEMET part number, insert M for ± 20% or K for ± 10%. Designates Capacitance tolerance.

2) To complete KEMET part number, insert T = 100% Matte Tin (Sn) Plated, G = Gold Plated, H = Standard Solder coated (SnPb 5% Pb minimum). Designates Termination Finish.

Refer to Ordering Information for additional detail.

Higher voltage ratings and tighter tolerance product including ESR may be substituted within the same size at KEMET's option. Voltage substitution will be marked with the higher voltage rating. Substitutions can include better than series.

Table 1 – Ratings & Part Number Reference con't

Rated Voltage	Rated Cap	Case Code/ Case Size	KEMET Part Number	DC Leakage		DF	ESR	Maximum Allowable Ripple Current			Moisture Sensitivity
				μAmps +20°C	+20°C 120Hz			+20°C 100kHz	+25°C 100kHz	+85°C 100kHz	
85°C	120Hz	KEMET/EIA	(See below for part options)	max/5min	% Max	Ohms	mAmps	mAmps	mAmps	Temp≤260°C	
VDC	μF			J-STD-020D							
16	100	D/7343-31	T491D107(1)016A(2)	16.0	8.0	0.7	463	417	185	1	
16	150	X/7343-43	T491X157(1)016A(2)	24.0	8.0	0.5	574	517	230	1	
16	150	D/7343-31	T491D157(1)016A(2)	24.0	12.0	0.7	463	417	185	1	
16	220	X/7343-43	T491X227(1)016A(2)	35.2	10.0	0.5	574	517	230	1	
16	220	D/7343-31	T491D227(1)016AT	35.2	15.0	0.9	408	367	163	1	
16	220	E/7260-38	T491E227(1)016A(2)	35.2	7.2	0.9	471	424	188	1	
20	0.47	R/2012-12	T491R474(1)020A(2)	0.1	4.0	35.0	27	24	11	1	
20	0.68	A/3216-18	T491A684(1)020A(2)	0.1	4.0	12.0	79	71	32	1	
20	1	A/3216-18	T491A105(1)020A(2)	0.2	4.0	9.0	91	82	36	1	
20	1	S/3216-12	T491S105(1)020A(2)	0.2	6.0	18.0	58	52	23	1	
20	1	R/2012-12	T491R105(1)020A(2)	0.2	6.0	20.0	35	32	14	1	
20	1.5	A/3216-18	T491A155(1)020A(2)	0.3	6.0	6.5	107	96	43	1	
20	1.5	S/3216-12	T491S155(1)020A(2)	0.3	6.0	15.0	63	57	25	1	
20	2.2	B/3528-21	T491B225(1)020A(2)	0.4	6.0	3.5	156	140	62	1	
20	2.2	A/3216-18	T491A225(1)020A(2)	0.4	0.6	7.0	104	94	42	1	
20	2.2	R/2012-12	T491R225(1)020A(2)	0.4	8.0	8.0	56	50	22	1	
20	3.3	B/3528-21	T491B335(1)020A(2)	0.7	6.0	3.0	168	151	67	1	
20	3.3	A/3216-18	T491A335(1)020A(2)	0.7	6.0	4.5	129	116	52	1	
20	3.3	T/3528-12	T491T335(1)020A(2)	0.7	6.0	5.0	118	106	47	1	
20	4.7	C/6032-28	T491C475(1)020A(2)	0.9	6.0	2.4	214	193	86	1	
20	4.7	B/3528-21	T491B475(1)020A(2)	0.9	6.0	3.0	168	151	67	1	
20	4.7	A/3216-18	T491A475(1)020A(2)	0.9	6.0	4.0	137	123	55	1	
20	6.8	C/6032-28	T491C685(1)020A(2)	1.4	6.0	1.9	241	217	96	1	
20	6.8	U/6032-15	T491U685(1)020A(2)	1.4	6.0	1.9	218	196	87	1	
20	6.8	B/3528-21	T491B685(1)020A(2)	1.4	6.0	2.5	184	166	74	1	
20	6.8	A/3216-18	T491A685(M)020A(2)	1.4	8.0	6.0	112	101	45	1	
20	10	C/6032-28	T491C106(1)020A(2)	2.0	6.0	1.8	247	222	99	1	
20	10	U/6032-15	T491U106(1)020A(2)	2.0	6.0	1.8	224	202	90	1	
20	10	B/3528-21	T491B106(1)020A(2)	2.0	6.0	2.1	201	181	80	1	
20	10	A/3216-18	T491A106(M)020A(2)	2.0	10.0	5.0	122	110	49	1	
20	15	D/7343-31	T491D156(1)020A(2)	3.0	6.0	1.0	387	348	155	1	
20	15	B/3528-21	T491B156(1)020AT	3.0	6.0	2.5	184	166	74	1	
20	15	C/6032-28	T491C156(1)020A(2)	3.0	6.0	1.7	254	229	102	1	
20	22	D/7343-31	T491D226(1)020A(2)	4.4	6.0	0.8	433	390	173	1	
20	22	V/7343-20	T491V226(1)020A(2)	4.4	6.0	0.7	423	381	169	1	
20	22	C/6032-28	T491C226(1)020A(2)	4.4	6.0	1.2	303	273	121	1	
20	22	B/3528-21	T491B226(1)020A(2)	4.4	8.0	4.0	146	131	58	1	
20	33	D/7343-31	T491D336(1)020A(2)	6.6	6.0	0.8	433	390	173	1	
20	33	C/6032-28	T491C336(M)020A(2)	6.6	6.0	1.2	303	273	121	1	
20	33	V/7343-20	T491V336(1)020A(2)	6.6	8.0	0.7	423	381	169	1	
20	33	B/3528-21	T491B336(M)020A(2)	6.6	10.0	4.0	146	131	58	1	
20	47	C/6032-28	T491C476(M)020A(2)	9.4	10.0	0.9	350	315	140	1	
20	47	X/7343-43	T491X476(1)020AT	9.4	6.0	0.8	454	409	182	1	
20	47	D/7343-31	T491D476(1)020A(2)	9.4	6.0	0.7	463	417	185	1	
20	68	X/7343-43	T491X686(1)020A(2)	13.6	6.0	0.7	486	437	194	1	
20	68	D/7343-31	T491D686(1)020A(2)	13.6	8.0	0.7	463	417	185	1	
20	100	X/7343-43	T491X107(1)020A(2)	20.0	8.0	0.5	574	517	230	1	
VDC	μF	KEMET/EIA	(See below for part options)	max/5min	% Max	Ohms	mAmps	mAmps	mAmps	J-STD-020D	
85°C	120Hz			μAmps +20°C	+20°C 120Hz	+20°C 100kHz	+25°C 100kHz	+85°C 100kHz	+125°C 100kHz	Temp≤260°C	
Rated Voltage	Rated Cap	Case Code/ Case Size	KEMET Part Number	DC Leakage	DF	ESR	Maximum Allowable Ripple Current			Moisture Sensitivity	

1) To complete KEMET part number, insert M for ± 20% or K for ± 10%. Designates Capacitance tolerance.

2) To complete KEMET part number, insert T = 100% Matte Tin (Sn) Plated, G = Gold Plated, H = Standard Solder coated (SnPb 5% Pb minimum). Designates Termination Finish.

Refer to Ordering Information for additional detail.

Higher voltage ratings and tighter tolerance product including ESR may be substituted within the same size at KEMET's option. Voltage substitution will be marked with the higher voltage rating. Substitutions can include better than series.

Table 1 – Ratings & Part Number Reference con't

Rated Voltage	Rated Cap	Case Code/ Case Size	KEMET Part Number	DC Leakage		DF	ESR	Maximum Allowable Ripple Current			Moisture Sensitivity
				μAmps +20°C	+20°C 120Hz			+20°C 100kHz	+25°C 100kHz	+85°C 100kHz	
85°C	120Hz	KEMET/EIA	(See below for part options)	max/5min	% Max	Ohms	mAmps	mAmps	mAmps	Temp≤260°C	
VDC	μF			J-STD-020D							
20	100	D/7343-31	T491D107(1)020AT	20.0	8.0	0.9	408	367	163	1	
20	100	E/7260-38	T491E107(1)020A(2)	20.0	8.0	0.5	632	569	253	1	
20	150	X/7343-43	T491X157(1)020A(2)	30.0	10.0	0.5	574	517	230	1	
25	0.33	A/3216-18	T491A334(1)025A(2)	0.1	4.0	15.0	71	64	28	1	
25	0.47	A/3216-18	T491A474(1)025A(2)	0.1	4.0	14.0	73	66	29	1	
25	0.68	A/3216-18	T491A684(1)025A(2)	0.2	4.0	10.0	87	78	35	1	
25	1	B/3528-21	T491B105(1)025A(2)	0.3	4.0	5.0	130	117	52	1	
25	1	A/3216-18	T491A105(1)025A(2)	0.3	4.0	8.0	97	87	39	1	
25	1	S/3216-12	T491S105(1)025A(2)	0.3	6.0	18.0	58	52	23	1	
25	1.5	B/3528-21	T491B155(1)025A(2)	0.4	6.0	5.0	130	117	52	1	
25	1.5	A/3216-18	T491A155(1)025A(2)	0.4	6.0	7.5	100	90	40	1	
25	1.5	R/2012-12	T491R155(1)025A(2)	0.4	8.0	8.0	56	50	22	1	
25	2.2	C/6032-28	T491C225(1)025A(2)	0.6	6.0	3.5	177	159	71	1	
25	2.2	A/3216-18	T491A225(1)025A(2)	0.6	6.0	7.0	104	94	42	1	
25	2.2	B/3528-21	T491B225(1)025A(2)	0.6	6.0	4.5	137	123	55	1	
25	3.3	C/6032-28	T491C335(1)025A(2)	0.8	6.0	2.5	210	189	84	1	
25	3.3	A/3216-18	T491A335(1)025A(2)	0.8	6.0	7.0	104	94	42	1	
25	3.3	B/3528-21	T491B335(1)025A(2)	0.8	6.0	3.5	156	140	62	1	
25	4.7	C/6032-28	T491C475(1)025A(2)	1.2	6.0	2.4	214	193	86	1	
25	4.7	B/3528-21	T491B475(1)025A(2)	1.2	6.0	1.5	238	214	95	1	
25	4.7	A/3216-18	T491A475(M)025A(2)	1.2	8.0	6.0	112	101	45	1	
25	6.8	C/6032-28	T491C685(1)025A(2)	1.7	6.0	1.9	241	217	96	1	
25	6.8	D/7343-31	T491D685(1)025AT	1.7	6.0	1.8	289	260	116	1	
25	6.8	B/3528-21	T491B685(1)025A(2)	1.7	8.0	2.8	174	157	70	1	
25	10	D/7343-31	T491D106(1)025A(2)	2.5	6.0	1.0	387	348	155	1	
25	10	C/6032-28	T491C106(1)025A(2)	2.5	6.0	1.5	271	244	108	1	
25	10	B/3528-21	T491B106(1)025A(2)	2.5	8.0	3.0	168	151	67	1	
25	15	D/7343-31	T491D156(1)025A(2)	3.8	6.0	1.0	387	348	155	1	
25	15	V/7343-20	T491V156(1)025AT	3.8	6.0	1.0	354	319	142	1	
25	15	C/6032-28	T491C156(1)025A(2)	3.8	6.0	1.5	271	244	108	1	
25	15	B/3528-21	T491B156(1)025A(2)	3.8	8.0	4.0	146	131	58	1	
25	22	D/7343-31	T491D226(1)025A(2)	5.5	6.0	0.8	433	390	173	1	
25	22	C/6032-28	T491C226(1)025A(2)	5.5	6.0	1.4	280	252	112	1	
25	22	V/7343-20	T491V226(1)025A(2)	5.5	6.0	0.7	423	381	169	1	
25	33	X/7343-43	T491X336(1)025A(2)	8.3	6.0	0.7	486	437	194	1	
25	33	D/7343-31	T491D336(1)025A(2)	8.3	6.0	0.7	463	417	185	1	
25	33	C/6032-28	T491C336(1)025A(2)	8.3	10.0	1.2	303	273	121	1	
25	47	X/7343-43	T491X476(1)025A(2)	11.8	6.0	0.7	486	437	194	1	
25	47	D/7343-31	T491D476(1)025A(2)	11.8	10.0	0.7	463	417	185	1	
25	68	X/7343-43	T491X686(M)025A(2)	17.0	8.0	0.7	486	437	194	1	
25	68	D/7343-31	T491D686(M)025A(2)	17.0	10.0	0.7	463	417	185	1	
25	100	X/7343-43	T491X107(1)025A(2)	25.0	8.0	0.3	742	668	297	1	
35	0.1	A/3216-18	T491A104(1)035A(2)	0.0	4.0	20.0	61	55	24	1	
35	0.15	A/3216-18	T491A154(1)035A(2)	0.1	4.0	19.0	63	57	25	1	
35	0.22	A/3216-18	T491A224(1)035A(2)	0.1	4.0	18.0	65	59	26	1	
35	0.33	A/3216-18	T491A334(1)035A(2)	0.1	4.0	15.0	71	64	28	1	
VDC	μF	KEMET/EIA	(See below for part options)	max/5min	% Max	Ohms	mAmps	mAmps	mAmps	J-STD-020D	
85°C	120Hz			μAmps +20°C	+20°C 120Hz	+20°C 100kHz	+25°C 100kHz	+85°C 100kHz	+125°C 100kHz	Temp≤260°C	
Rated Voltage	Rated Cap	Case Code/ Case Size	KEMET Part Number	DC Leakage	DF	ESR	Maximum Allowable Ripple Current			Moisture Sensitivity	

1) To complete KEMET part number, insert M for ± 20% or K for ± 10%. Designates Capacitance tolerance.

2) To complete KEMET part number, insert T = 100% Matte Tin (Sn) Plated, G = Gold Plated, H = Standard Solder coated (SnPb 5% Pb minimum). Designates Termination Finish.

Refer to Ordering Information for additional detail.

Higher voltage ratings and tighter tolerance product including ESR may be substituted within the same size at KEMET's option. Voltage substitution will be marked with the higher voltage rating. Substitutions can include better than series.

Table 1 – Ratings & Part Number Reference con't

Rated Voltage	Rated Cap	Case Code/ Case Size	KEMET Part Number	DC Leakage		DF	ESR	Maximum Allowable Ripple Current			Moisture Sensitivity
				μAmps +20°C	+20°C 120Hz			+25°C 100kHz	+85°C 100kHz	+125°C 100kHz	
85°C	120Hz	KEMET/EIA	(See below for part options)	max/5min	% Max	Ohms	mAmps	mAmps	mAmps	Temp≤260°C	
VDC	μF			J-STD-020D							
35	0.47	B/3528-21	T491B474(1)035A(2)	0.2	4.0	8.0	103	93	41	1	
35	0.47	A/3216-18	T491A474(1)035A(2)	0.2	4.0	12.0	79	71	32	1	
35	0.68	B/3528-21	T491B684(1)035A(2)	0.2	4.0	6.5	114	103	46	1	
35	0.68	A/3216-18	T491A684(1)035A(2)	0.2	4.0	8.0	97	87	39	1	
35	1	B/3528-21	T491B105(1)035A(2)	0.4	4.0	5.0	130	117	52	1	
35	1	A/3216-18	T491A105(1)035A(2)	0.4	4.0	7.5	100	90	40	1	
35	1.5	C/6032-28	T491C155(1)035A(2)	0.5	6.0	4.5	156	140	62	1	
35	1.5	B/3528-21	T491B155(1)035A(2)	0.5	6.0	5.0	130	117	52	1	
35	2.2	C/6032-28	T491C225(1)035A(2)	0.8	6.0	3.5	177	159	71	1	
35	2.2	A/3216-18	T491A225(1)035AT	0.8	6.0	4.5	129	116	52	1	
35	2.2	B/3528-21	T491B225(1)035A(2)	0.8	6.0	4.0	146	131	58	1	
35	3.3	C/6032-28	T491C335(1)035A(2)	1.2	6.0	2.5	210	189	84	1	
35	3.3	B/3528-21	T491B335(1)035A(2)	1.2	6.0	3.5	156	140	62	1	
35	4.7	D/7343-31	T491D475(1)035A(2)	1.6	6.0	1.5	316	284	126	1	
35	4.7	B/3528-21	T491B475(1)035AT	1.6	6.0	3.1	166	149	66	1	
35	4.7	C/6032-28	T491C475(1)035A(2)	1.6	6.0	2.2	224	202	90	1	
35	6.8	D/7343-31	T491D685(1)035A(2)	2.4	6.0	1.3	340	306	136	1	
35	6.8	V/7343-20	T491V685(1)035AT	2.4	6.0	1.2	323	291	129	1	
35	6.8	C/6032-28	T491C685(1)035A(2)	2.4	6.0	1.8	247	222	99	1	
35	10	D/7343-31	T491D106(1)035A(2)	3.5	6.0	1.0	387	348	155	1	
35	10	C/6032-28	T491C106(M)035A(2)	3.5	6.0	1.6	262	236	105	1	
35	10	V/7343-20	T491V106(1)035A(2)	3.5	6.0	2.0	250	225	100	1	
35	15	X/7343-43	T491X156(1)035A(2)	5.3	6.0	0.9	428	385	171	1	
35	15	C/6032-28	T491C156(1)035AT	5.3	6.0	1.4	280	252	112	1	
35	15	D/7343-31	T491D156(1)035A(2)	5.3	6.0	0.8	433	390	173	1	
35	22	X/7343-43	T491X226(1)035A(2)	7.7	6.0	0.7	486	437	194	1	
35	22	D/7343-31	T491D226(1)035A(2)	7.7	6.0	0.7	463	417	185	1	
35	33	X/7343-43	T491X336(1)035A(2)	11.6	6.0	0.6	524	472	210	1	
35	47	X/7343-43	T491X476(1)035A(2)	16.5	8.0	0.6	524	472	210	1	
35	47	E/7260-38	T491E476(1)035A(2)	16.5	10.0	0.5	632	569	253	1	
50	0.1	A/3216-18	T491A104(1)050A(2)	0.1	4.0	20.0	61	55	24	1	
50	0.15	B/3528-21	T491B154(1)050A(2)	0.1	4.0	16.0	73	66	29	1	
50	0.15	A/3216-18	T491A154(1)050A(2)	0.1	4.0	15.0	71	64	28	1	
50	0.22	B/3528-21	T491B224(1)050A(2)	0.1	4.0	14.0	78	70	31	1	
50	0.22	A/3216-18	T491A224(1)050AT	0.1	4.0	18.0	65	59	26	1	
50	0.33	B/3528-21	T491B334(1)050A(2)	0.2	4.0	10.0	92	83	37	1	
50	0.47	C/6032-28	T491C474(1)050A(2)	0.2	4.0	8.0	117	105	47	1	
50	0.47	B/3528-21	T491B474(1)050A(2)	0.2	4.0	9.0	97	87	39	1	
50	0.68	C/6032-28	T491C684(1)050A(2)	0.3	4.0	7.0	125	113	50	1	
50	0.68	B/3528-21	T491B684(1)050A(2)	0.3	4.0	8.0	103	93	41	1	
50	1	C/6032-28	T491C105(1)050A(2)	0.5	4.0	5.5	141	127	56	1	
50	1	B/3528-21	T491B105(1)050A(2)	0.5	6.0	6.0	119	107	48	1	
50	1	V/7343-20	T491V105(1)050A(2)	0.5	4.0	6.0	144	130	58	1	
50	1.5	D/7343-31	T491D155(1)050A(2)	0.8	6.0	3.5	207	186	83	1	
50	1.5	C/6032-28	T491C155(1)050A(2)	0.8	6.0	4.5	156	140	62	1	
50	2.2	D/7343-31	T491D225(1)050A(2)	1.1	6.0	2.5	245	221	98	1	
50	2.2	C/6032-28	T491C225(1)050A(2)	1.1	6.0	3.0	191	172	76	1	
VDC	μF	KEMET/EIA	(See below for part options)	max/5min	% Max	Ohms	mAmps	mAmps	mAmps	J-STD-020D	
85°C	120Hz			μAmps +20°C	+20°C 120Hz	+20°C 100kHz	+25°C 100kHz	+85°C 100kHz	+125°C 100kHz	Temp≤260°C	
Rated Voltage	Rated Cap	Case Code/ Case Size	KEMET Part Number	DC Leakage	DF	ESR	Maximum Allowable Ripple Current			Moisture Sensitivity	

1) To complete KEMET part number, insert M for ± 20% or K for ± 10%. Designates Capacitance tolerance.

2) To complete KEMET part number, insert T = 100% Matte Tin (Sn) Plated, G = Gold Plated, H = Standard Solder coated (SnPb 5% Pb minimum). Designates Termination Finish.

Refer to Ordering Information for additional detail.

Higher voltage ratings and tighter tolerance product including ESR may be substituted within the same size at KEMET's option. Voltage substitution will be marked with the higher voltage rating. Substitutions can include better than series.

Table 1 – Ratings & Part Number Reference con't

Rated Voltage	Rated Cap	Case Code/ Case Size	KEMET Part Number	DC Leakage		DF	ESR	Maximum Allowable Ripple Current			Moisture Sensitivity
				μ Amps +20°C	+20°C 120Hz			+25°C 100kHz	+85°C 100kHz	+125°C 100kHz	
VDC	μ F	KEMET/EIA	(See below for part options)	max/5min	% Max	Ohms	mAmps	mAmps	mAmps	J-STD-020D	
50	3.3			C/6032-28	T491C335(1)050AT	1.7	6.0	2.5	210	189	84
50	3.3	D/7343-31	T491D335(1)050A(2)	1.7	6.0	2.0	274	247	110	1	
50	4.7	D/7343-31	T491D475(1)050A(2)	2.4	6.0	1.4	327	294	131	1	
50	6.8	X/7343-43	T491X685(1)050A(2)	3.4	6.0	1.0	406	365	162	1	
50	6.8	D/7343-31	T491D685(1)050A(2)	3.4	6.0	1.0	387	348	155	1	
50	10	X/7343-43	T491X106(M)050A(2)	5.0	6.0	0.7	486	437	194	1	
50	10	D/7343-31	T491D106(1)050A(2)	5.0	6.0	0.8	433	390	173	1	
50	15	X/7343-43	T491X156(1)050A(2)	7.5	8.0	0.7	486	437	194	1	
50	22	X/7343-43	T491X226(1)050A(2)	11.0	10.0	0.6	524	472	210	1	
VDC	μ F	KEMET/EIA	(See below for part options)	max/5min	% Max	Ohms	mAmps	mAmps	mAmps	J-STD-020D	
85°C	120Hz			μ Amps +20°C	+20°C 120Hz	+20°C 100kHz	+25°C 100kHz	+85°C 100kHz	+125°C 100kHz	Temp \leq 260°C	
Rated Voltage	Rated Cap	Case Code/ Case Size	KEMET Part Number	DC Leakage	DF	ESR	Maximum Allowable Ripple Current			Moisture Sensitivity	

1) To complete KEMET part number, insert M for \pm 20% or K for \pm 10%. Designates Capacitance tolerance.

(2) To complete KEMET part number, insert T = 100% Matte Tin (Sn) Plated, G = Gold Plated, H = Standard Solder coated (SnPb 5% Pb minimum).

Designates Termination Finish.

Refer to Ordering Information for additional detail.

Higher voltage ratings and tighter tolerance product including ESR may be substituted within the same size at KEMET's option. Voltage substitution will be marked with the higher voltage rating. Substitutions can include better than series.

Recommended Voltage Derating Guidelines

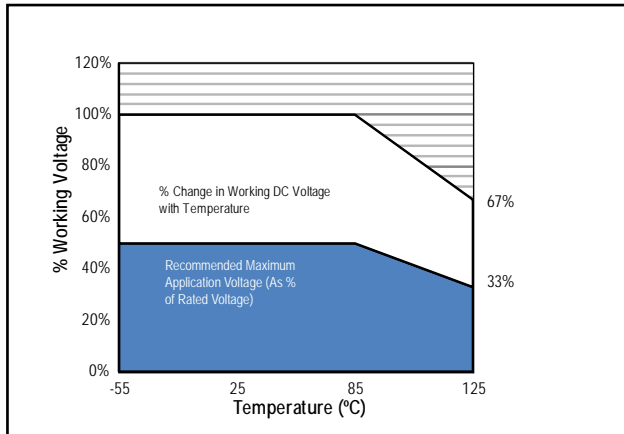

Ripple Current/Ripple Voltage

Case Code		Maximum Power Dissipation (Pmax) mWatts @ 25°C w/+20°C Rise
KEMET	EIA	
A	3216-18	75
B	3528-21	85
C	6032-28	110
D	7343-31	150
X	7343-43	165
E	7260-38	200
R	2012-12	25
S	3216-12	60
T	3528-12	70
U	6032-15	90
V	7343-20	125
T510X	7343-43	270
T510E	7260-38	285

Temperature Compensation Multipliers for Maximum Power Dissipation		
≤25°C	85°C	125°C
1.00	0.90	0.40

T = Environmental Temperature

Using the P max of the device, the maximum allowable rms ripple current or voltage may be determined.

$$I(max) = \sqrt{P_{max}/R}$$

$$E(max) = \sqrt{P_{max} \cdot R}$$

I = rms ripple current (amperes)

E = rms ripple voltage (volts)

*P*_{max} = maximum power dissipation (watts)

R = ESR at specified frequency (ohms)

Reverse Voltage

Solid tantalum capacitors are polar devices and may be permanently damaged or destroyed if connected with the wrong polarity. The positive terminal is identified on the capacitor body by a stripe plus in some cases a beveled edge. A small degree of transient reverse voltage is permissible for short periods per the table. The capacitors should not be operated continuously in reverse mode, even within these limits.

Temperature	Permissible Transient Reverse Voltage
25°C	15% of Rated Voltage
85°C	5% of Rated Voltage
125°C	1% of Rated Voltage

Table 2 – Land Dimensions/Courtyard

KEMET	Metric Size Code	Density Level A: Maximum (Most) Land Protrusion (mm)					Density Level B: Median (Nominal) Land Protrusion (mm)					Density Level C: Minimum (Least) Land Protrusion (mm)				
		Case	EIA	X	Y	C	V1	V2	X	Y	C	V1	V2	X	Y	C
A	3216-18	1.35	2.15	1.45	6.10	2.80	1.25	1.75	1.35	5.00	2.30	1.15	1.35	1.25	4.10	2.00
B	3528-21	2.35	2.15	1.45	6.10	4.00	2.25	1.75	1.35	5.00	3.50	2.15	1.35	1.25	4.10	3.20
C	6032-28	2.35	2.65	2.60	8.90	4.40	2.25	2.25	2.50	7.80	3.90	2.15	1.85	2.40	6.90	3.60
D	7343-31	2.55	3.75	2.70	10.20	5.50	2.45	3.35	2.60	9.10	5.00	2.35	2.95	2.50	8.20	4.70
E ¹	7260-38	4.25	2.65	3.20	10.10	7.20	4.15	2.25	3.30	9.40	6.70	4.05	1.85	3.00	8.10	6.40
R	2012-12	1.05	1.80	1.00	4.80	2.40	0.95	1.45	0.90	3.80	1.90	0.85	1.05	0.80	2.90	1.60
S ²	3216-12	1.35	2.15	1.45	6.10	2.80	1.25	1.75	1.35	5.00	2.30	1.15	1.35	1.25	4.10	2.00
T	3528-12	2.35	2.15	1.45	6.10	4.00	2.25	1.75	1.35	5.00	3.50	2.15	1.35	1.25	4.10	3.20
U	6032-15	2.55	3.75	2.70	10.20	5.50	2.45	3.35	2.60	9.10	5.00	2.35	2.95	2.50	8.20	4.70
V	7343-20	2.55	3.75	2.70	10.20	5.50	2.45	3.35	2.60	9.10	5.00	2.35	2.95	2.50	8.20	4.70
X ¹	7343-43	2.55	3.75	2.70	10.20	5.50	2.45	3.35	2.60	9.10	5.00	2.35	2.95	2.50	8.20	4.70

Density Level A: For low-density product applications. Recommended for wave solder applications and provides a wider process window for reflow solder processes.

Density Level B: For products with a moderate level of component density. Provides a robust solder attachment condition for reflow solder processes.

Density Level C: For high component density product applications. Before adapting the minimum land pattern variations the user should perform qualification testing based on the conditions outlined in IPC standard 7351 (IPC-7351).

¹ Height of these chips may create problems in wave soldering.

² Land pattern geometry is too small for silkscreen outline.

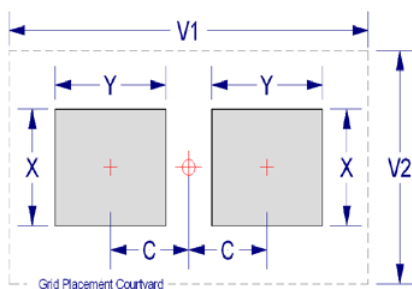

Soldering Process

KEMET's families of surface mount capacitors are compatible with wave (single or dual), convection, IR or vapor phase reflow techniques. Preheating of these components is recommended to avoid extreme thermal stress. KEMET's recommended profile conditions for convection and IR reflow reflect the profile conditions of the IPC/J-STD-020D standard for moisture sensitivity testing. The devices can safely withstand a maximum of three reflow passes at these conditions.

Note that although the X/7343-43 case size can withstand wave soldering, the tall profile (4.3 mm maximum) dictates care in wave process development.

Hand soldering should be performed with care due to the difficulty in process control. If performed, care should be taken to avoid contact of the soldering iron to the molded case. The iron should be used to heat the solder pad, applying solder between the pad and the termination, until reflow occurs. Once reflow occurs, the iron should be removed immediately. "Wiping" the edges of a chip and heating the top surface is not recommended.

During typical reflow operations, a slight darkening of the gold-colored epoxy may be observed. This slight darkening is normal and is not harmful to the product. Marking permanency is not affected by this change.

Profile Feature	SnPb Assembly	Pb-Free Assembly
Preheat/Soak		
Temperature Min (T_{Smin})	100°C	150°C
Temperature Max (T_{Smax})	150°C	200°C
Time (t_s) from T_{Smin} to T_{Smax}	60–120 sec	60–120 sec
Ramp-up Rate (T_L to T_p)	3°C/sec max	3°C/sec max
Liquidous Temperature (T_L)	183°C	217°C
Time Above Liquidous (t_L)	60–150 sec	60–150 sec
Peak Temperature (T_p)	220°C* 235°C**	250°C* 260°C**
Time within 5°C of Max Peak Temperature (t_p)	20 sec max	30 sec max
Ramp-down Rate (T_p to T_L)	6°C/sec max	6°C/sec max
Time 25°C to Peak Temperature	6 minutes max	8 minutes max

Note: All temperatures refer to the center of the package, measured on the package body surface that is facing up during assembly reflow.

*Case Size D, E, P, Y and X

**Case Size A, B, C, H, I, K, M, R, S, T, U, V, W and Z

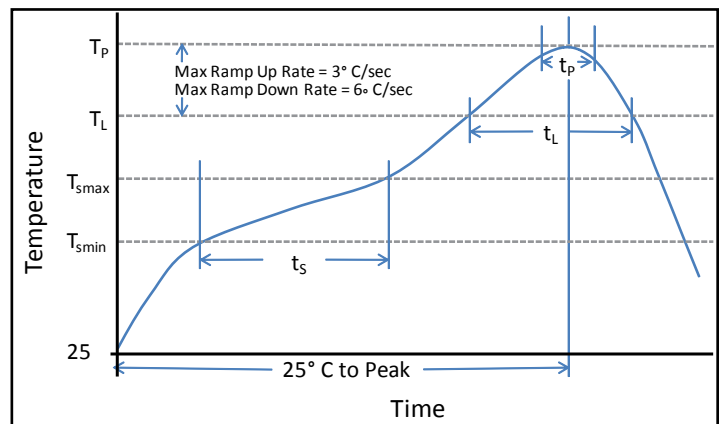

Construction

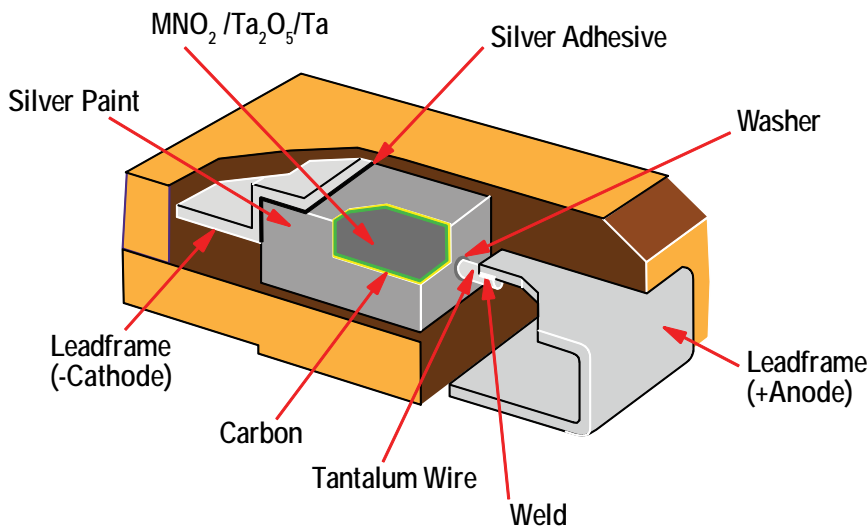

Capacitor Marking

C, D, X Case Sizes

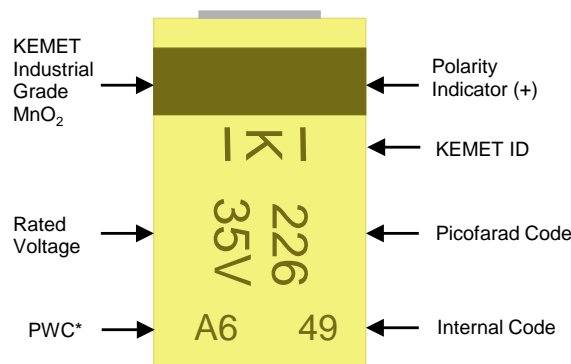
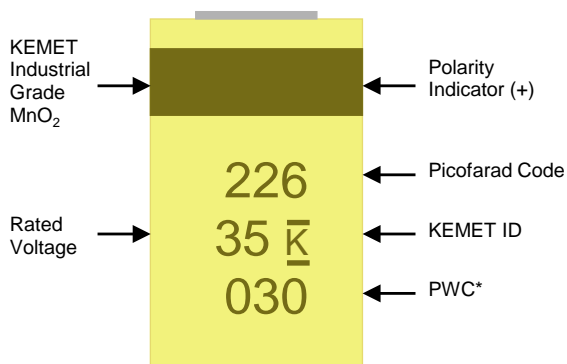

* 030 = 30th week of 2010

PWC*		
Year	Month	
V = 2008	1 = Jan	7 = Jul
W = 2008	2 = Feb	8 = Aug
X = 2009	3 = Mar	9 = Spt
A = 2010	4 = Apr	O = Oct
B = 2011	5 = May	N = Nov
C = 2012	6 = Jun	D = Dec

Storage

Tantalum chip capacitors should be stored in normal working environments. While the chips themselves are quite robust in other environments, solderability will be degraded by exposure to high temperatures, high humidity, corrosive atmospheres, and long term storage. In addition, packaging materials will be degraded by high temperature - reels may soften or warp, and tape peel force may increase. KEMET recommends that maximum storage temperature not exceed 40°C, and maximum storage humidity not exceed 60% relative humidity. In addition, temperature fluctuations should be minimized to avoid condensation on the parts, and atmospheres should be free of chlorine and sulphur bearing compounds. For optimized solderability, chip stock should be used promptly, preferably within three years of receipt.

Tape & Reel Packaging Information

KEMET's Molded Tantalum and Aluminum Chip Capacitor families are packaged in 8 mm and 12 mm plastic tape on 7" and 13" reels, in accordance with EIA Standard 481-D: Taping of Surface Mount Components for Automatic Handling. This packaging system is compatible with all tape fed automatic pick and place systems.

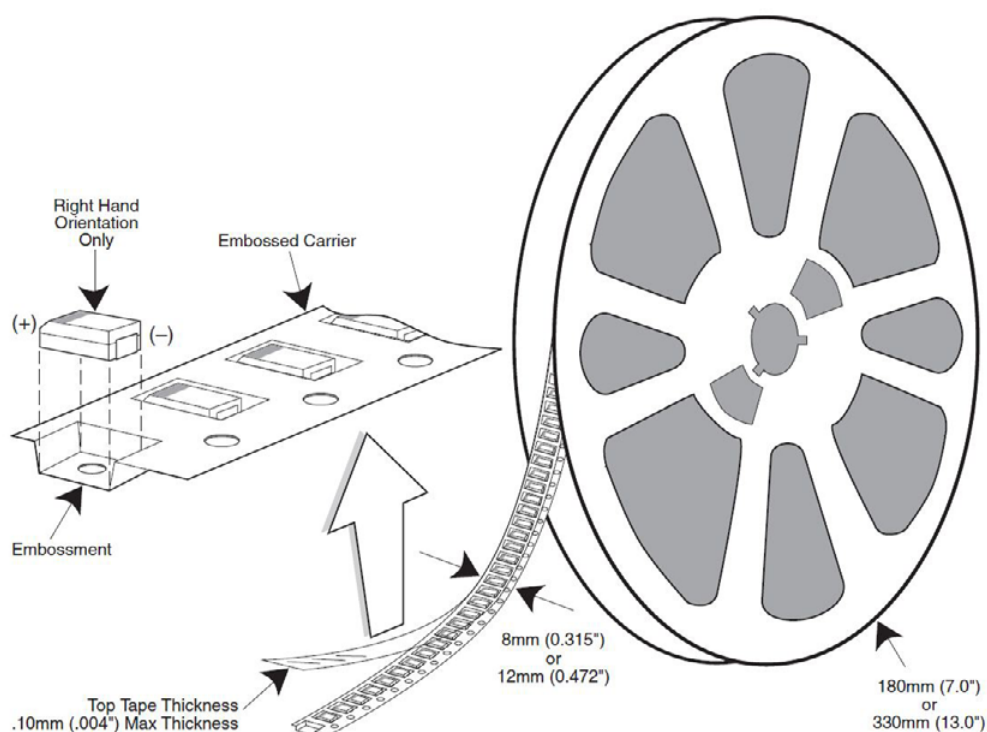

Table 3 – Packaging Quantity

Case Code		Tape Width-mm	7" Reel*	13" Reel*
KEMET	EIA			
R	2012-12	8	2,500	10,000
I	3216-10	8	3,000	12,000
S	3216-12	8	2,500	10,000
T	3528-12	8	2,500	10,000
M	3528-15	8	2,000	8,000
U	6032-15	12	1,000	5,000
L	6032-19	12	1,000	5,000
W	7343-15	12	1,000	3,000
Z	7343-17	12	1,000	3,000
V	7343-20	12	1,000	3,000
A	3216-18	8	2,000	9,000
B	3528-21	8	2,000	8,000
C	6032-28	12	500	3,000
D	7343-31	12	500	2,500
Y	7343-40	12	500	2,000
X	7343-43	12	500	2,000
E	7260-38	12	500	2,000

* No c-spec required for 7" reel packaging. C-7280 required for 13" reel packaging.

Figure 1 – Embossed (Plastic) Carrier Tape Dimensions

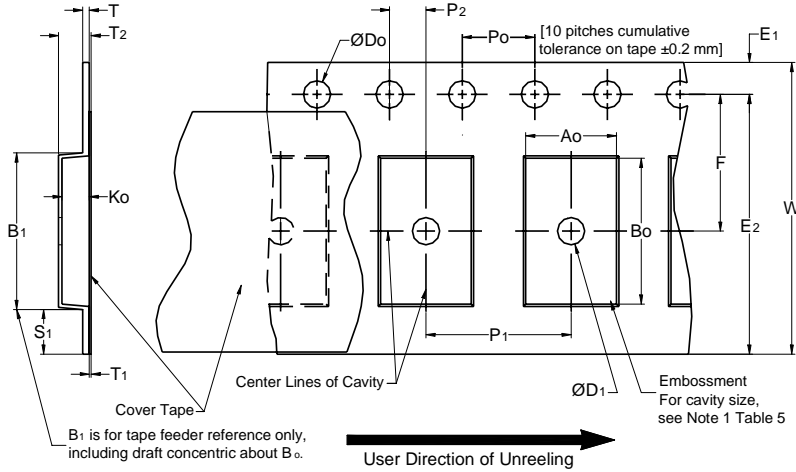

Table 4 – Embossed (Plastic) Carrier Tape Dimensions

Metric will govern

Constant Dimensions — Millimeters (Inches)									
Tape Size	D ₀	D ₁ Min. Note 1	E ₁	P ₀	P ₂	R Ref. Note 2	S ₁ Min. Note 3	T Max.	T ₁ Max.
8mm	1.5 +0.10/-0.0 (0.059 +0.004/-0.0)	1.0 (0.039)	1.75 ± 0.10 (0.069 ± 0.004)	4.0 ± 0.10 (0.157 ± 0.004)	2.0 ± 0.05 (0.079 ± 0.002)	25.0 (0.984)	0.600 (0.024)	0.600 (0.024)	0.100 (0.004)
12mm		1.5 (0.059)				30 (1.181)			
16mm									
Variable Dimensions — Millimeters (Inches)									
Tape Size	Pitch	B ₁ Max. Note 4	E ₂ Min.	F	P ₁	T ₂ Max	W Max	A ₀ , B ₀ & K ₀	
8mm	Single (4mm)	4.35 (0.171)	6.25 (0.246)	3.5 ± 0.05 (0.138 ± 0.002)	4.0 ± 0.10 (0.157 ± 0.004)	2.5 (0.098)	8.3 (0.327)	Note 5	
12mm	Single (4mm) & Double (8mm)	8.2 (0.323)	10.25 (0.404)	5.5 ± 0.05 (0.217 ± 0.002)	8.0 ± 0.10 (0.315 ± 0.004)	4.6 (0.181)	12.3 (0.484)		
16mm	Triple (12mm)	12.1 (0.476)	14.25 (0.561)	5.5 ± 0.05 (0.217 ± 0.002)	8.0 ± 0.10 (0.315 ± 0.004)	4.6 (0.181)	16.3 (0.642)		

1. The embossment hole location shall be measured from the sprocket hole controlling the location of the embossment. Dimensions of embossment location and hole location shall be applied independent of each other.
2. The tape with or without components shall pass around R without damage (see Figure 5).
3. If S₁ < 1.0 mm, there may not be enough area for cover tape to be properly applied (see EIA Document 481 paragraph 4.3 (b)).
4. B₁ dimension is a reference dimension for tape feeder clearance only.
5. The cavity defined by A₀, B₀ and K₀ shall surround the component with sufficient clearance that:
 - (a) the component does not protrude above the top surface of the carrier tape.
 - (b) the component can be removed from the cavity in a vertical direction without mechanical restriction, after the top cover tape has been removed.
 - (c) rotation of the component is limited to 20° maximum for 8 and 12mm tapes and 10° maximum for 16mm tapes (see Figure 3).
 - (d) lateral movement of the component is restricted to 0.5 mm maximum for 8mm and 12mm wide tape and to 1.0mm maximum for 16mm tape (see Figure 4).
 - (e) see Addendum in EIA Document 481 for standards relating to more precise taping requirements.

Packaging Information Performance Notes

1. **Cover Tape Break Force:** 1.0 Kg minimum.
2. **Cover Tape Peel Strength:** The total peel strength of the cover tape from the carrier tape shall be:

Tape Width	Peel Strength
8mm	0.1 Newton to 1.0 Newton (10gf to 100gf)
12mm & 16mm	0.1 Newton to 1.3 Newton (10gf to 130gf)

The direction of the pull shall be opposite the direction of the carrier tape travel. The pull angle of the carrier tape shall be 165° to 180° from the plane of the carrier tape. During peeling, the carrier and/or cover tape shall be pulled at a velocity of 300±10 mm/minute.

3. **Labeling:** Bar code labeling (standard or custom) shall be on the side of the reel opposite the sprocket holes. Refer to EIA-556 and EIA-624.

Figure 2 – Maximum Component Rotation

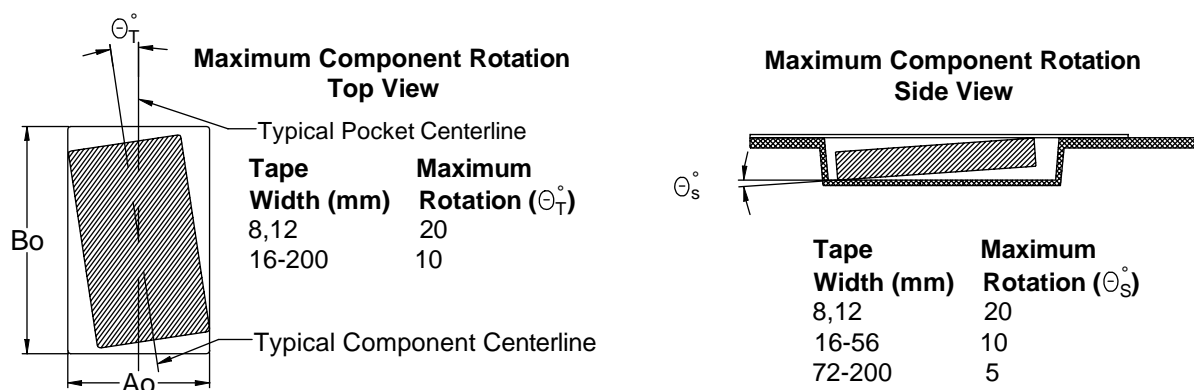

Figure 3 – Maximum Lateral Movement

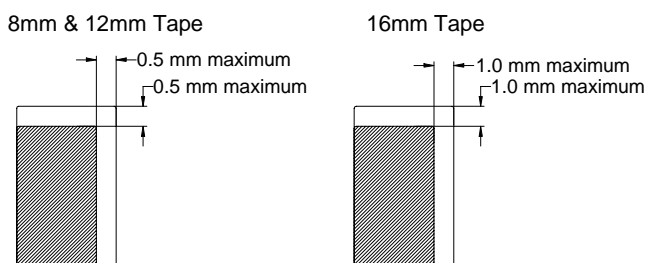

Figure 4 – Bending Radius

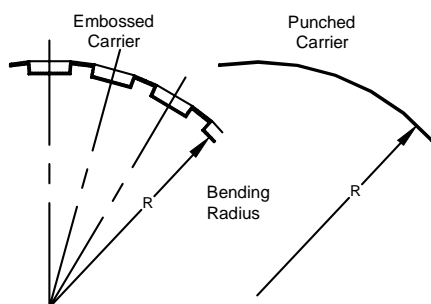
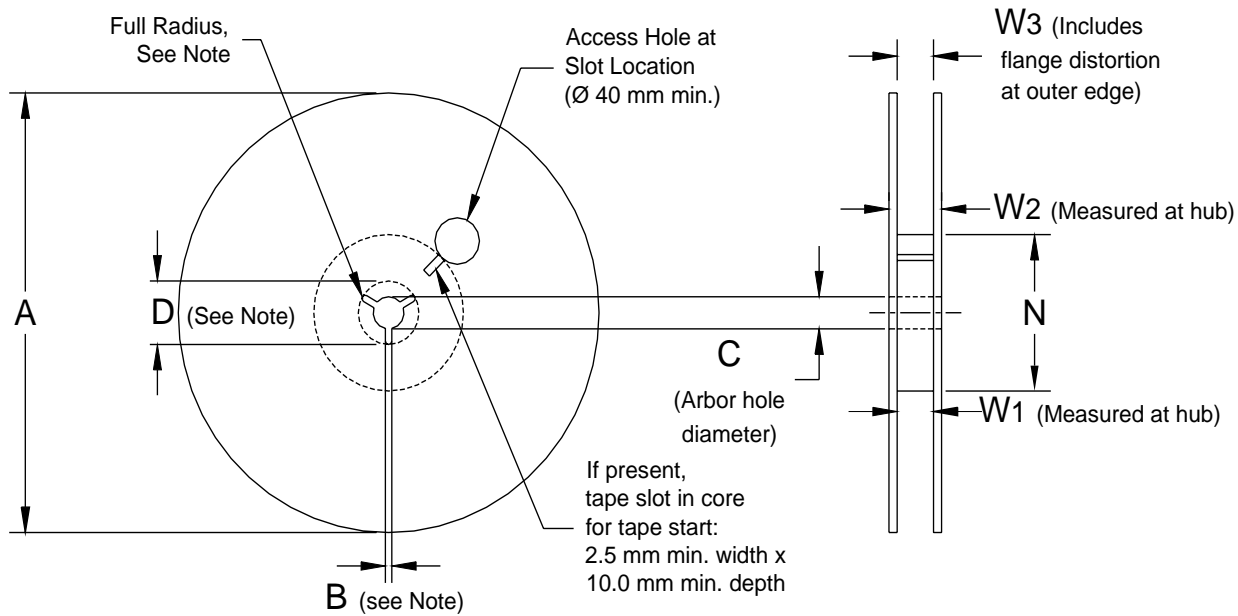

Figure 5 – Reel Dimensions



Note: Drive spokes optional; if used, dimensions B and D shall apply.

Table 5 – Reel Dimensions

Metric will govern

Constant Dimensions — Millimeters (Inches)				
Tape Size	A	B Min	C	D Min
8mm	178 ± 0.20 (7.008 ± 0.008)	1.5 (0.059)	13.0 +0.5/-0.2 (0.521 +0.02/-0.008)	20.2 (0.795)
12mm	or			
16mm	330 ± 0.20 (13.000 ± 0.008)			
Variable Dimensions — Millimeters (Inches)				
Tape Size	N Min	W ₁	W ₂ Max	W ₃
8mm	50 (1.969)	8.4 +1.5/-0.0 (0.331 +0.059/-0.0)	14.4 (0.567)	Shall accommodate tape width without interference
12mm		12.4 +2.0/-0.0 (0.488 +0.078/-0.0)	18.4 (0.724)	
16mm		16.4 +2.0/-0.0 (0.646 +0.078/-0.0)	22.4 (0.882)	

Figure 6 – Tape Leader & Trailer Dimensions

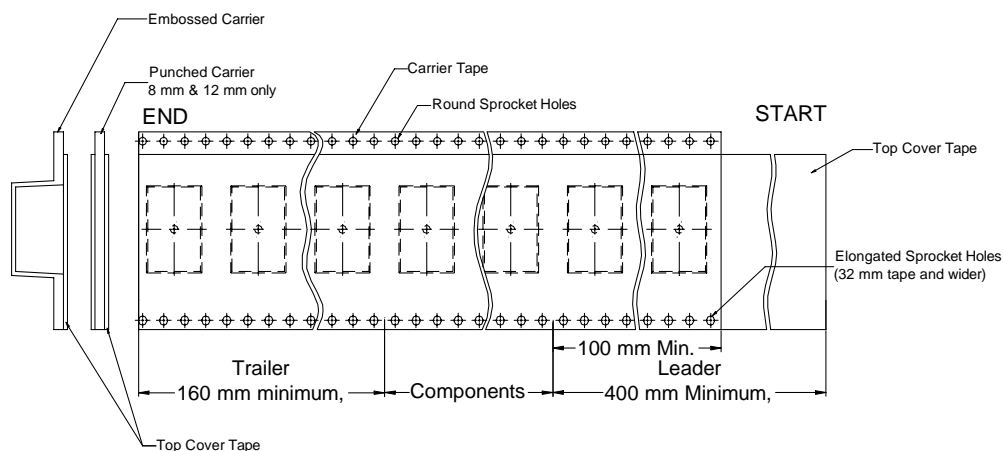
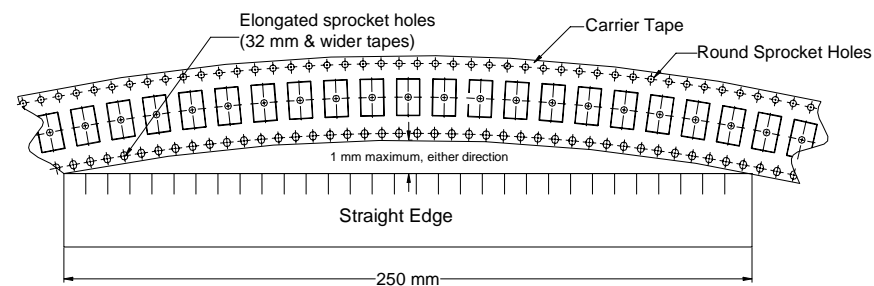

Figure 7 – Maximum Camber



KEMET Corporation World Headquarters

2835 KEMET Way
Simpsonville, SC 29681

Mailing Address:
P.O. Box 5928
Greenville, SC 29606

www.kemet.com
Tel: 864-963-6300
Fax: 864-963-6521

Corporate Offices

Fort Lauderdale, FL
Tel: 954-766-2800

North America

Southeast

Lake Mary, FL
Tel: 407-855-8886

Northeast

Wilmington, MA
Tel: 978-658-1663

West Chester, PA
Tel: 610-692-4642

Central

Schaumburg, IL
Tel: 847-882-3590

Carmel, IN
Tel: 317-706-6742

West

Milpitas, CA
Tel: 408-433-9950

Mexico

Zapopan, Jalisco
Tel: 52-33-3123-2141

Europe

Southern Europe

Geneva, Switzerland
Tel: 41-22-715-0100

Paris, France
Tel: 33-1-4646-1009

Sasso Marconi, Italy
Tel: 39-051-939111

Milan, Italy
Tel: 39-02-57518176

Rome, Italy
Tel: 39-06-23231718

Madrid, Spain
Tel: 34-91-804-4303

Central Europe

Landsberg, Germany
Tel: 49-8191-3350800

Dortmund, Germany
Tel: 49-2307-3619672

Kwidzyn, Poland
Tel: 48-55-279-7025

Northern Europe

Bishop's Stortford, United Kingdom
Tel: 44-1279-757201

Weymouth, United Kingdom
Tel: 44-1305-830747

Coatbridge, Scotland
Tel: 44-1236-434455

Färjestaden, Sweden
Tel: 46-485-563934

Espoo, Finland
Tel: 358-9-5406-5000

Asia

Northeast Asia

Hong Kong
Tel: 852-2305-1168

Shenzhen, China
Tel: 86-755-2518-1306

Beijing, China
Tel: 86-10-5829-1711

Shanghai, China
Tel: 86-21-6447-0707

Taipei, Taiwan
Tel: 886-2-27528585

Southeast Asia

Singapore
Tel: 65-6586-1900

Penang, Malaysia
Tel: 60-4-6430200

Bangalore, India
Tel: 91-806-53-76817

Note: KEMET reserves the right to modify minor details of internal and external construction at any time in the interest of product improvement. KEMET does not assume any responsibility for infringement that might result from the use of KEMET Capacitors in potential circuit designs. KEMET is a registered trademark of KEMET Electronics Corporation.

Other KEMET Resources

Tools	
Resource	Location
Configure A Part: CapEdge	http://capacitoredge.kemet.com
SPICE & FIT Software	http://www.kemet.com/spice
Search Our FAQs: KnowledgeEdge	http://www.kemet.com/keask

Product Information	
Resource	Location
Products	http://www.kemet.com/products
Technical Resources (Including Soldering Techniques)	http://www.kemet.com/technicalpapers
RoHS Statement	http://www.kemet.com/rohs
Quality Documents	http://www.kemet.com/qualitydocuments

Product Request	
Resource	Location
Sample Request	http://www.kemet.com/sample
Engineering Kit Request	http://www.kemet.com/kits

Contact	
Resource	Location
Website	www.kemet.com
Contact Us	http://www.kemet.com/contact
Investor Relations	http://www.kemet.com/ir
Call Us	1-877-MyKEMET
Twitter	http://twitter.com/kemetcapacitors

Disclaimer

All product specifications, statements, information and data (collectively, the "Information") are subject to change without notice.

All Information given herein is believed to be accurate and reliable, but is presented without guarantee, warranty, or responsibility of any kind, expressed or implied.

Statements of suitability for certain applications are based on our knowledge of typical operating conditions for such applications, but are not intended to constitute – and we specifically disclaim – any warranty concerning suitability for a specific customer application or use. This Information is intended for use only by customers who have the requisite experience and capability to determine the correct products for their application. Any technical advice inferred from this Information or otherwise provided by us with reference to the use of our products is given gratis, and we assume no obligation or liability for the advice given or results obtained.

Although we design and manufacture our products to the most stringent quality and safety standards, given the current state of the art, isolated component failures may still occur. Accordingly, customer applications which require a high degree of reliability or safety should employ suitable designs or other safeguards (such as installation of protective circuitry or redundancies) in order to ensure that the failure of an electrical component does not result in a risk of personal injury or property damage.

Although all product-related warnings, cautions and notes must be observed, the customer should not assume that all safety measures are indicated or that other measures may not be required.

