

The Best Relayion



W11 Relay



108-98010
Rev. C
EC-JM00-0009-03
ECOC: JM10
1. Aug. 04

1 pole PCB relay, non-polarized,
Through Hole Type (THT)

Relay types: Non-latching, 1 coil
Terminal assignments symmetrical or assymetrical
5- or 6-pin version

Features

- Multi purpose relay
- Small size permitting high packing density
- 1 changeover contact (1 form C / SPDT)
- 200 mW and 450 mW coils
- 1 A and 3 A contacts
- High shock resistance of 30 g
- Ambient temperature for sensitive version up to 85°C
- Immersion cleanable

Typical applications

- Security devices
- Electric door openers
- Duplex intercommunication systems
- Measurement and controls



UL 508

File No. E111441

European Directive conformance:

W11 relay product conformance according to:

- Directive 2000/53/EC: ELV (End of Life of Vehicles)
- Directive 2002/95/EC: ROHS (Restrictions of the use of certain hazardous substances in electrical and electronic equipment)

Compliance is evidenced by written declaration from all raw material suppliers.

Tyco Electronics AXICOM only has responsibility for the proper processing of these materials.

Confirmation is valid for date codes \geq 0401

Dimension drawing (in mm)

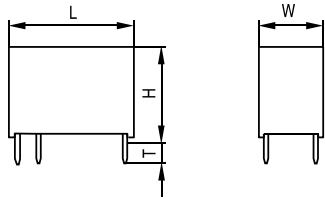

V23101-Dxxx-Xxxx		
	mm	inch
L	15.5 ± 0.1	0.610 ± 0.004
W	10.5 ± 0.1	0.413 ± 0.004
H	11.5 - 0.2	0.453 - 0.008
T	3.5 - 0.2	0.138 - 0.008

Mounting hole layout

View on to the component side of the PCB

Version: 6 pins

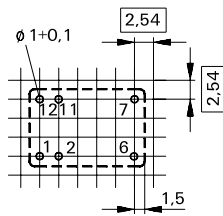

Version: 5 pins (without pin no. 6)

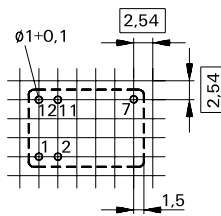

Terminal assignment

Relay - top view

6 pin version with symmetrical coil assignment
V23101-D0 xxx -A xxx

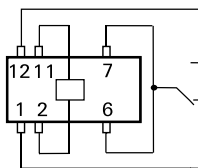

5 pin version with symmetrical coil assignment
V23101-D1 xxx -A xxx

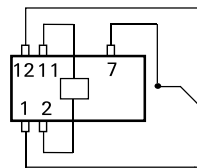

6 pin version with asymmetrical coil assignment
V23101-D0 xxx -B xxx

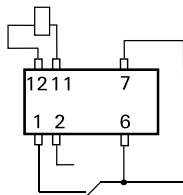

5 pin version with asymmetrical coil assignment
V23101-D1 xxx -B xxx

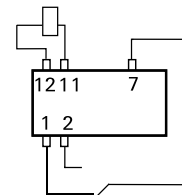

Coil Data (values at 23°C)				Ordering Information			
Nominal voltage U_{nom}	Operate/set voltage range		Release/ reset voltage Minimum	Coil power	Coil Resistance	Relay code	Tyco part number
	Minimum voltage U_{min}	Maximum voltage U_{max}					
Vdc	Vdc	Vdc	Vdc	mW	$\Omega / \pm 10\%$		
6 pin version with symmetrical coil assignment, 450 mW nom. Power consumption, AgPd+Au contacts							
1.5	1.3	2.6	0.15	375	6	V23101-D0001-A201	0-1393779-1
3	2.1	4.7	0.30	450	20	V23101-D0002-A201	0-1393779-3
5	3.5	7.9	0.50	446	56	V23101-D0003-A201	0-1393779-5
6	4.2	9.5	0.60	450	80	V23101-D0004-A201	0-1393779-8
9	6.3	14.2	0.90	450	180	V23101-D0005-A201	1-1393779-1
12	8.4	19.0	1.20	450	320	V23101-D0006-A201	1-1393779-3
24	16.8	38.0	2.40	450	1280	V23101-D0007-A201	1-1393779-8
6 pin version with asymmetrical coil assignment, 450 mW nom. Power consumption, AgPd+Au contacts							
1.5	1.3	2.6	0.15	375	6	V23101-D0001-B201	0-1393779-2
3	2.1	4.7	0.30	450	20	V23101-D0002-B201	0-1393779-4
5	3.5	7.9	0.50	446	56	V23101-D0003-B201	0-1393779-6
6	4.2	9.5	0.60	450	80	V23101-D0004-B201	1-1393779-0
9	6.3	14.2	0.90	450	180	V23101-D0005-B201	1-1393779-2
12	8.4	19.0	1.20	450	320	V23101-D0006-B201	1-1393779-6
24	16.8	38.0	2.40	450	1280	V23101-D0007-B201	2-1393779-0
6 pin version with symmetrical coil assignment, 450 mW nom. Power consumption, AgNi contacts							
12	8.4	19.0	0.20	450	320	V23101-D0006-A301	4-1419172-4
6 pin version with asymmetrical coil assignment, 450 mW nom. Power consumption, AgNi contacts							
5	3.5	7.9	0.50	446	56	V23101-D0003-B301	0-1393779-7
12	8.4	19.0	1.20	450	320	V23101-D0006-B301	1-1393779-7
24	16.8	38.0	2.40	450	1280	V23101-D0007-B301	2-1393779-1
6 pin version with symmetrical coil assignment, 450 mW nom. Power consumption, AgNi+Au contacts							
5	3.5	7.9	0.50	446	56	V23101-D0003-A401	0-1422028-2
12	8.4	19.0	1.20	450	320	V23101-D0006-A401	0-1422028-3
24	16.8	38.0	2.40	450	1280	V23101-D0007-A401	0-1422028-5
6 pin version with asymmetrical coil assignment, 450 mW nom. Power consumption, AgNi+Au contacts							
12	8.4	19.0	1.20	450	320	V23101-D0006-B401	0-1422028-4
24	16.8	38.0	2.40	450	1280	V23101-D0007-B401	0-1422028-6
5 pin version with symmetrical coil assignment, 450 mW nom. Power consumption, AgPd+Au contacts							
12	8.4	19.0	1.20	450	320	V23101-D1006-A201	4-1393779-1
5 pin version with asymmetrical coil assignment, 450 mW nom. Power consumption, AgPd+Au contacts							
5	3.5	7.9	0.50	446	56	V23101-D1003-B201	4-1393779-0
12	8.4	19.0	1.20	450	320	V23101-D1006-B201	4-1393779-2
24	16.8	38.0	2.40	450	1280	V23101-D1007-B201	0-1413012-1
5 pin version with symmetrical coil assignment, 450 mW nom. Power consumption, AgNi+Au contacts							
12	8.4	19.0	1.20	450	320	V23101-D1006-A401	1-1422028-2
5 pin version with asymmetrical coil assignment, 450 mW nom. Power consumption, AgNi+Au contacts							
12	8.4	19.0	1.20	450	320	V23101-D1006-B401	1-1422028-3
6 pin version with symmetrical coil assignment, 200 mW nom. Power consumption, AgPd+Au contacts							
1.5	1.1	3.6	0.15	188	12	V23101-D0101-A201	2-1393779-2
3	2.3	7.1	0.30	200	45	V23101-D0102-A201	2-1393779-4
5	3.8	11.6	0.50	208	120	V23101-D0103-A201	2-1393779-6
6	4.5	14.2	0.60	200	180	V23101-D0104-A201	2-1393779-8
9	6.8	21.2	0.90	203	400	V23101-D0105-A201	3-1393779-0
12	9.0	28.0	1.20	206	700	V23101-D0106-A201	3-1393779-2
24	18.0	56.0	2.40	206	2800	V23101-D0107-A201	3-1393779-5
18	13.5	33.0	1.80	200	1620	V23101-D0108-A201	3-1393779-9

Coil Data (values at 23 °C)				Ordering Information			
Nominal voltage U_{nom}	Operate/set voltage range		Release/ reset voltage Minimum	Coil power	Coil Resistance	Relay code	Tyco part number
	Minimum voltage U_{min}	Maximum voltage U_{max}					
Vdc	Vdc	Vdc	Vdc	mW	$\Omega / \pm 10\%$		

6 pin version with asymmetrical coil assignment, 200 mW nom. Power consumption, AgPd+Au contacts

1.5	1.1	3.6	0.15	188	12	V23101-D0101-B201	2-1393779-3
3	2.3	7.1	0.30	200	45	V23101-D0102-B201	2-1393779-5
5	3.8	11.6	0.50	208	120	V23101-D0103-B201	2-1393779-7
6	4.5	14.2	0.60	200	180	V23101-D0104-B201	2-1393779-9
9	6.8	21.2	0.90	203	400	V23101-D0105-B201	3-1393779-1
12	9.0	28.0	1.20	206	700	V23101-D0106-B201	3-1393779-3
24	18.0	56.0	2.40	206	2800	V23101-D0107-B201	3-1393779-8

6 pin version with symmetrical coil assignment, 200 mW nom. Power consumption, AgNi contacts

12	9.0	28.0	1.20	206	700	V23101-D0006-A301	0-1422037-2
24	18.0	56.0	2.40	206	2800	V23101-D0007-A301	3-1393779-7

6 pin version with asymmetrical coil assignment, 200 mW nom. Power consumption, AgNi contacts

12	9.0	28.0	1.20	206	700	V23101-D0106-B301	3-1393779-4
----	-----	------	------	-----	-----	-------------------	-------------

6 pin version with symmetrical coil assignment, 200 mW nom. Power consumption, AgNi+Au contacts

5	3.8	11.6	0.50	208	120	V23101-D0103-A401	0-1422028-7
12	9.0	28.0	1.20	203	700	V23101-D0106-A401	0-1422028-8
24	18.0	56.0	2.40	206	2800	V23101-D0107-A401	0-1422028-9
18	13.5	33.0	1.80	200	1620	V23101-D0108-A401	1-1422028-1

6 pin version with asymmetrical coil assignment, 200 mW nom. Power consumption, AgNi+Au contacts

24	18.0	56.0	2.40	206	2800	V23101-D0107-B401	1-1422028-0
----	------	------	------	-----	------	-------------------	-------------

5 pin version with symmetrical coil assignment, 200 mW nom. Power consumption, AgPd+Au contacts

12	9.0	28.0	1.20	203	700	V23101-D1106-A201	4-1393779-3
24	18.0	56.0	2.40	206	2800	V23101-D1107-A201	4-1393779-6

5 pin version with asymmetrical coil assignment, 200 mW nom. Power consumption, AgPd+Au contacts

12	9.0	28.0	1.20	203	700	V23101-D1106-B201	4-1393779-4
24	18.0	56.0	2.40	206	2800	V23101-D1107-B201	4-1393779-7

5 pin version with asymmetrical coil assignment, 200 mW nom. Power consumption, AgNi contacts

12	9.0	28.0	1.20	203	700	V23101-D1106-B301	4-1393779-5
----	-----	------	------	-----	-----	-------------------	-------------

5 pin version with symmetrical coil assignment, 200 mW nom. Power consumption, AgNi+Au contacts

12	9.0	28.0	1.20	203	700	V23101-D1106-A401	1-1422028-4
----	-----	------	------	-----	-----	-------------------	-------------

5 pin version with asymmetrical coil assignment, 200 mW nom. Power consumption, AgNi+Au contacts

12	9.0	28.0	1.20	203	700	V23101-D1106-B401	1-1422028-5
----	-----	------	------	-----	-----	-------------------	-------------

Coil operating range

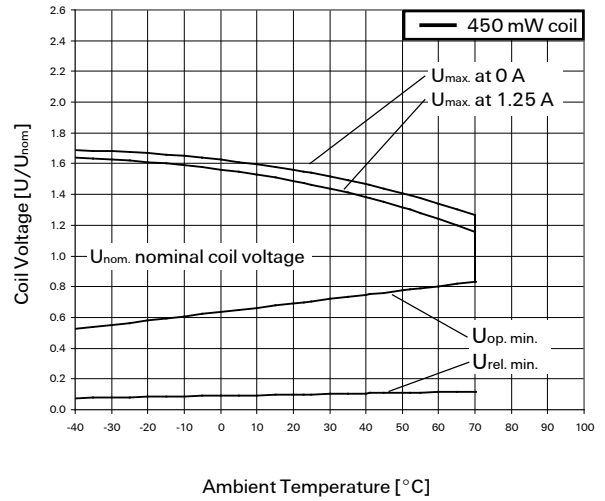
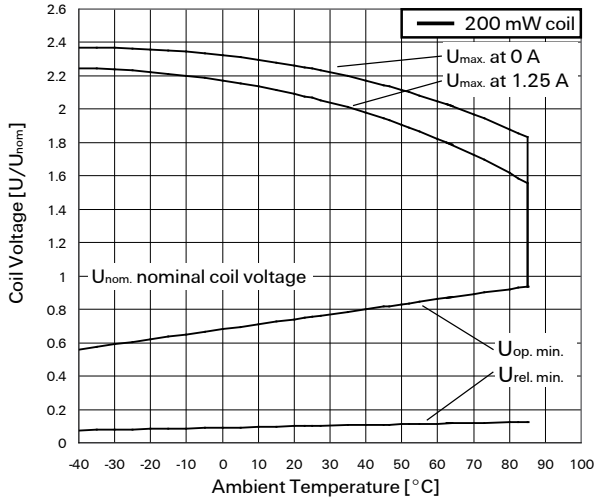

Ordering Code

V 2 3 1 0 1

Identification of the Relay W11 - 1 changeover contact

Pin version

D0 = Standard 6 pins
D1 = 5-pin version (without pin no. 6)

Coil number

Standard version
001 = 1.5 V nominal voltage
002 = 3 V
003 = 5 V
004 = 6 V
005 = 9 V
006 = 12 V
007 = 24 V

Sensitive version
101 = 1.5 V nominal voltage
102 = 3 V
103 = 5 V
104 = 6 V
105 = 9 V
106 = 12 V
107 = 24 V

Contact / material

A = Symmetrical coil assignment
B = Asymmetrical coil assignment

201 = AgPd, gold plated
301 = AgNi
401 = AgNi, gold plated

Ordering example: V23101-D0104-B401

Small relay W11 - 1 changeover contact, standard pin version (6 pins), sensitive version, coil 6 V nominal voltage, terminal assignment B, contact material AgNi, gold plated.

Note:

Special designs can be carried out to customer specifications. Please contact your local representative.

Contact Data

Number of contacts and type	1 changeover contact	
Contact assembly	single contacts	
Contact material	AgPd, gold plated AgNi, gold plated	AgNi
Limiting continuous current at max. ambient temperature	1.25 A	3 A
Maximum switching current (see load limit diagram)	1.25 A	3 A
Maximum switching voltage	120 Vdc 125 Vac	120 Vdc 125 Vac
Maximum switching capacity	30 W / 62.5 VA	72 W / 360 VA
Thermoelectric potential	< 10 μ V	< 10 μ V
Initial contact resistance / measuring condition: 10 mA / 20 mV	100 m Ω	100 m Ω
Electrical endurance		
standard:		
at 24 Vdc / 1.25 A	3 x 10 ⁵	
at 24 Vdc / 3 A		2 x 10 ⁵
at 120 Vac / 1.25 A	1.5 x 10 ⁵	
at 120 Vac / 3 A		4 x 10 ⁵
sensitive:		
at 24 Vdc / 1.25 A	2 x 10 ⁵	
at 24 Vdc / 3 A		1 x 10 ⁵
at 120 Vac / 1.25 A	1 x 10 ⁵	
at 120 Vac / 3 A		3 x 10 ⁵
Mechanical endurance	typ. 10 ⁷ operations	

Max. DC load breaking capacity

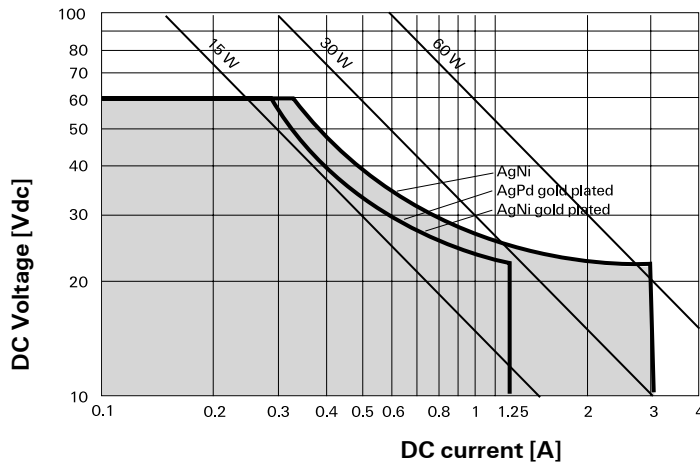

Insulation

Insulation resistance at 500 VDC	> 10 ⁹ Ω
Dielectric test voltage (1 min)	
between coil and contacts	1000 Vrms
between open contacts	750 Vrms

High Frequency Data

Capacitance	
between coil and contacts	max. 10 pF
between open contacts	max. 2 pF

General data

Operate time at U_{nom} typ. / max.	5 ms / 7 ms
Release time without diode in parallel, typ. / max.	3 ms / 5 ms
Release time with diode in parallel, typ. / max.	10 ms / 12 ms
Bounce time at closing contact, typ. / max.	1 ms / 2 ms NO contact 5 ms / 10 ms at NC contact
Maximum switching rate without load	20 operations/s
Ambient temperature	-40° C ... +70° C/85° C, standard / sensitive coil
Thermal resistance	< 125 K/W
Maximum permissible coil temperature	130° C
Vibration resistance (function)	10 G, 10 to 200 Hz
Shock resistance, half sinus, 11 ms	30 G (function) 100 G (damage)
Degree of protection	immersion cleanable, IP 67
Needle flame test	application time 20 s, burning time < 15 s
Mounting position	any
Processing information	Ultrasonic cleaning is not recommended
Weight (mass)	max. 4 g
Terminal coating	SnCu 0,7
Resistance to soldering heat	260° C / 10 s

All data refers to 23° C unless otherwise specified.

Packing

Dimensions in mm

Tube dimensions - 25 relays per tube, 625 relays per box

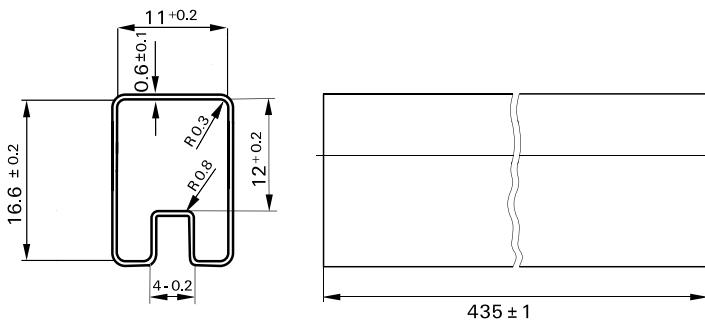

IM Relays

4th generation slim line – low profile polarized 2 c/o telecom relay with bifurcated contacts, available as non latching or latching relay with 1 coil. Nominal voltage range from 1.5... 24 V, coil power consumption of 140... 200 mW, latching relays with 1 coil 100 mW. The IM relay is available as through hole and surface mount type (J-Legs and Gull Wings) and capable to switch loads up to 60 W/62,5 VA. Dielectric strength fulfills the Bellcore requirements according GR 1089 (2,5 kV – 2 / 10 μ s) and FCC part 68 (1,5 kV – 10 / 160 μ s). The IM relay is CECC/IECQ approved and certified in accordance with IEC/EN 60950 and UL1950. Dimensions approx. 10 x 6 mm board space and 5.65 mm height.

P2 Relays

3rd generation polarized 2 c/o telecom relay with bifurcated contacts, available as non latching or latching relay with 1 or 2 coils. Nominal voltage range from 3 ... 24 V, coil power consumption 140 mW, latching relays with 1 coil 70 mW. The P2 relay is available as through hole or surface mount type and capable to switch currents up to 5 A. Dielectric strength fulfills the Bellcore requirements according GR 1089 (2,5 kV – 2 / 10 μ s) and FCC part 68 (1,5 kV – 10 / 160 μ s). Dimensions approx. 15 x 7,5 mm board space and 10 mm height.

FX Relays

3rd generation polarized 2 c/o telecom relay with bifurcated contacts, available as non latching or latching relay with 1 coil. Nominal voltage range from 3 ... 48 V, coil power consumption of 80 ... 260 mW for the high sensitive version, 140... 300 mW for the standard version, latching relays with 1 coil 100 mW. The FX2 relay is available as through hole type and capable to switch loads up to 60 W/62,5 VA. Dielectric strength fulfills the Bellcore requirements according GR 1089 (2,5 kV – 2 / 10 μ s) and FCC part 68 (1,5 kV – 10 / 160 μ s). The FX2 is CECC/IECQ approved and certified in accordance with IEC/EN 60950 and UL1950. Dimensions approx. 15 x 7,5 mm board space and 10,7 mm height.

FT2 / FU2 Relays

3rd generation non polarized, non latching 2 c/o telecom relay with bifurcated contacts. Nominal voltage range from 3 ... 48 V, coil power consumption 200 ... 300 mW. Most sensitive 48 V relay. Available as through hole and surface mount type. Dielectric strength fulfills the Bellcore requirements according GR 1089 (2,5 kV – 2 / 10 μ s) and FCC part 68 (1,5 kV – 10 / 160 μ s). The FT2/FU2 is CECC/IECQ approved and certified in accordance with IEC/EN 60950 and UL1950. Dimensions approx. 15 x 7,5 mm board space and 10 mm height.

FP2 Relays

3rd generation polarized 2 c/o telecom relay with bifurcated contacts, available as non latching or latching relay with 1 or 2 coils. Nominal voltage range from 3 ... 48 V, coil power consumption of 80 ... 260 mW for the high sensitive version, 140... 300 mW for the standard version, latching relays with 1 coil 100 mW. The FP2 relay is available as through hole type and capable to switch loads up to 30 W/62,5 VA. Dielectric strength fulfills FCC part 68 (1,5 kV – 10 / 160 μ s). The FP2 is CECC/IECQ approved. Dimensions approx. 14 x 9 mm board space and 5 mm height.

MT2 / MT4

2nd generation non polarized, non latching 2 c/o and 4 c/o telecom and signal relay with bifurcated contacts. Nominal voltage range from 4.5 ... 48 V, coil power consumption 150/200/300/400 and 550 mW, and 300 mW (MT4). Dielectric strength fulfills the requirements according FCC part 68 (1,5 kV – 10 / 160 μ s) for both

and the Bellcore requirements according GR 1089 (2,5 kV – 2 / 10 μ s) the MT4 only.

Dimensions MT2 approx. 20 x 10 mm board space and 11 mm height, MT4 approx. 20 x 15 mm board space and 11 mm height.

D2n Relays

2nd generation non polarized 2 c/o relay for telecom and various other applications. Nominal voltage range from 3 ... 48 V, coil power consumption from 150 ... 500 mW. The D2n relay is capable to switch currents up to 3 A. Dielectric strength fulfills the requirements according FCC part 68 (1,5 kV – 10 / 160 μ s). Dimensions approx. 20 x 10 mm board space and 11,5 mm height.

P1 Relays

Extremely sensitive, polarized 1 c/o relay with bifurcated contacts for a wide range of applications, available as non latching or latching relay with 1 or 2 coils. Nominal voltage range from 3 ... 24 V, coil power consumption 65 mW, latching relays with 1 coil 30 mW. The P1 relay is available as through hole or surface mount type and capable to switch currents up to 1 A. Dielectric strength fulfills the requirements according FCC part 68 (1,5 kV – 10 / 160 μ s). Dimensions approx. 13 x 7,6 mm board space and 7 mm height for THT or 8 mm height for SMT version.

W11 Relays

Low cost, non polarized 1 c/o relay for various applications. Nominal voltage range from 3 ... 24 V, coil power consumption 450 mW, sensitive versions 200 mW. The W11 relay is capable to switch currents up to 3 A. Dielectric strength 1000 Vrms. Dimensions approx. 15,6 x 10,6 mm board space and 11,5 mm height.

Reed Relays

High sensitive, non polarized relay for telecom and various other applications, available with 1 n/o, 2 n/o or 1 c/o contacts. Nominal voltage range from 5 ... 24 V, coil power consumption 50...280 mW for 1 n/o and 125 ... 280 mW for 2 n/o or 1 c/o versions. Reedrelays are available in DIP or SIL housing and capable to switch currents up to 0,5 A. Integrated diode and/or electrostatic shield optional. Dielectric strength 1500 Vdc. Dimensions approx. 19,3 x 7 mm board space and 5 ... 7,5 mm height for DIP or 19,8 x 5 mm board space and 7,8 mm height for SIL version.

Cradle Relays

Extremely reliable and mature relay family of 1st generation for various signal switching applications. Available as non polarized, polarized / latching and relay with AC coil. The benefit is the possibility of combining various contact sets from 1 up to 6 poles, single and bifurcated contacts, different contact materials with a coil voltage range from 1,5 Vdc to 220 Vac. Cradle relays are available as dust protected and hermetically sealed versions, with plug in or solder terminals and are capable to switch currents up to 5 A. Forcibly guided (linked) contact sets optional. Dielectric strength 500 Vrms. Dimensions from approx. 19 x 24 to 19x35 mm board space and 30 mm height.

Other Relays

We offer a variety of different relay families for maintenance and replacement purposes. These relays are up to 60 years old now, such as Card Relay SN (V23030 / V23031 series), Small General Purpose Relay (V23006 series), Small Polarized Relay (V23063 ... V23067 and V23163 ... V23167 series). Accessories like sockets, hold down springs, etc. optional.



Tyco Electronics AXICOM Ltd.
Seestrasse 295 - P.O. Box 220
CH-8804 Au-Wädenswil / Switzerland
Phone +41 1 782 9111
Fax +41 1 782 9080
E-mail: axicom@tycoelectronics.com



Tyco Electronics
Paulsternstrasse 26
D-13629 Berlin / Germany
Phone +49 30 386 38573
Fax +49 30 386 38575
E-mail: axicom@tycoelectronics.com



Tyco Electronics EC Trutnov s.r.o.
Komenského 821
CZ-541 01 Trutnov / Czech Republic
E-mail: axicom@tycoelectronics.com

Tyco Electronics Corporation
POB 3608,
Harrisburg, PA 17105, USA
Phone +001 800-522-6752