

## LMV712

# Low Power, Low Noise, High Output, RRIO Dual Operational Amplifier with Independent Shutdown

### General Description

The LMV712 duals are high performance BiCMOS operational amplifiers intended for applications requiring Rail-to-Rail inputs combined with speed and low noise. They offer a bandwidth of 5MHz and a slew rate of 5 V/ $\mu$ s and can handle capacitive loads of up to 200pF without oscillation.

The LMV712 offers two independent shutdown pins. This feature allows disabling of each device separately and reduces the supply current to less than 1 $\mu$ A typical. The output voltage rapidly ramps up smoothly with no glitch as the amplifier comes out of the shutdown mode.

The LMV712 with the shutdown feature is offered in space saving 10-Bump micro SMD and 10 pin Leadless Leadframe Package (LLP) packages. It is also offered in 10 lead MSOP package. These packages are designed to meet the demands of small size, low power, and low cost required by cellular phones and similar battery operated portable electronics.

### Features

(Typical Unless Otherwise Noted)

- 5 MHz GBP
- Slew rate 5 V/ $\mu$ s
- Low noise 20nV/ $\sqrt{\text{Hz}}$
- Supply current 1.22mA/channel
- $V_{OS} < 3\text{mV max.}$
- Low supply voltage 2.7V to 5V.
- Rail-to-Rail inputs and outputs.
- Unity gain stable.
- Small package: 10-Pin LLP, 10-Pin MSOP and 10-Bump micro SMD
- 1.5 $\mu$ A shutdown  $I_{CC}$
- 2.2 $\mu$ s turn on

### Applications

- Power amplifier control loop
- Cellular phones
- Portable equipment
- Wireless LAN
- Radio systems
- Cordless phones

### Typical Application Circuit

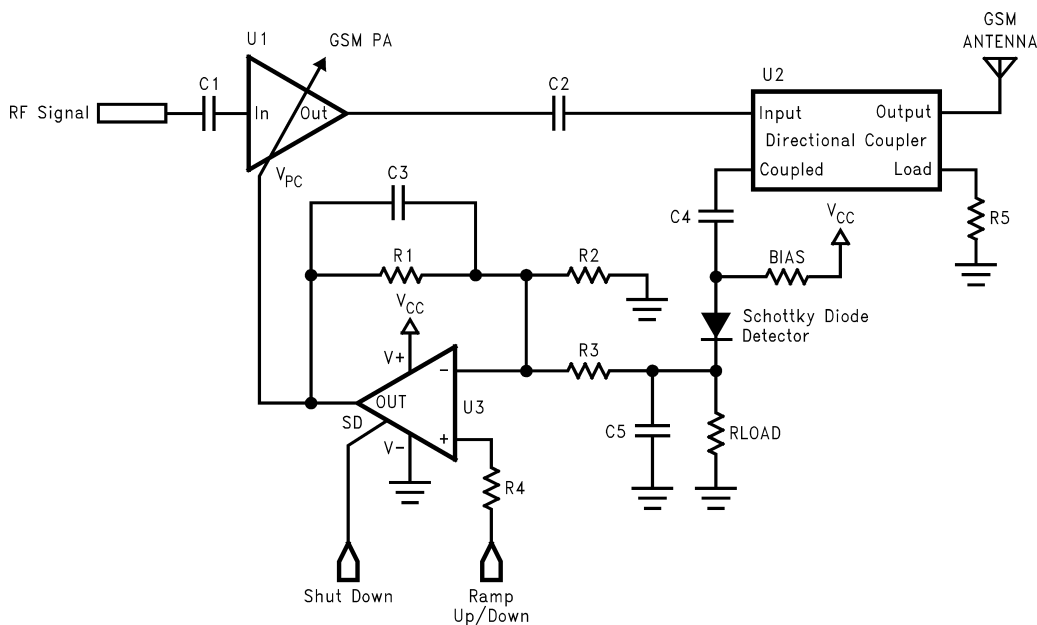

P.A. Control Loop

10137034

**Absolute Maximum Ratings** (Note 1)

If Military/Aerospace specified devices are required, please contact the National Semiconductor Sales Office/ Distributors for availability and specifications.

ESD Tolerance (Note 2)	
Human Body Model	1.5kV
Machine Model	150V
Differential Input Voltage	±Supply Voltage
Voltage at Input/Output Pin	(V <sup>+</sup> ) +0.4V to (V <sup>-</sup> ) -0.4V
Supply Voltage (V <sup>+</sup> - V <sup>-</sup> )	5.5V
Output Short Circuit V <sup>+</sup>	(Note 3)
Output Short Circuit V <sup>-</sup>	(Note 3)
Current at Input Pin	±10mA
Current at Output Pin	±50mA
Storage Temp Range	-65°C to 150°C

Mounting Temperature

Infrared or Convection (20 sec)

235°C

Junction Temperature T<sub>JMAX</sub> (Note 4)

150°C

**Recommended Operating Conditions** (Note 1)

Supply Voltage	2.7V to 5V
Temperature Range	-40°C ≤ T <sub>J</sub> ≤ 85°C
Thermal Resistance	
10-Pin MSOP	235°C/W
10-Pin LLP	53.4°C/W
10-Bump micro SMD	196°C/W

**2.7V Electrical Characteristics**

Unless otherwise specified, all limits guaranteed for V<sup>+</sup> = 2.7V, V<sup>-</sup> = 0V, V<sub>CM</sub> = 1.35V and T<sub>A</sub> = 25°C and R<sub>L</sub> > 1MΩ. **Boldface** limits apply at the temperature extremes.

Symbol	Parameter	Condition	Min (Note 6)	Typ (Note 5)	Max (Note 6)	Units	
V <sub>OS</sub>	Input Offset Voltage	V <sub>CM</sub> = 0.85V and V <sub>CM</sub> = 1.85V	MSOP LLP BL Packages		0.4	3	mV
					3	7	
					<b>3.2</b>		
					<b>9</b>		
I <sub>B</sub>	Input Bias Current			5.5	115 <b>130</b>	pA	
CMRR	Common Mode Rejection Ratio	0V ≤ V <sub>CM</sub> ≤ 2.7V	50 <b>45</b>	75		dB	
PSRR	Power Supply Rejection Ratio	2.7V ≤ V <sup>+</sup> ≤ 5V, V <sub>CM</sub> = 0.85V	70 <b>68</b>	90		dB	
		2.7V ≤ V <sup>+</sup> ≤ 5V, V <sub>CM</sub> = 1.85V	70 <b>68</b>	90		dB	
CMVR	Common Mode Voltage Range	For CMRR ≥ 50dB		-0.3	-0.2	V	
				2.9	3		
I <sub>SC</sub>	Output Short Circuit Current	Sourcing V <sub>O</sub> = 0V	15 <b>12</b>	25		mA	
		Sinking V <sub>O</sub> = 2.7V	25 <b>22</b>	50		mA	
V <sub>O</sub>	Output Swing	R <sub>L</sub> = 10kΩ to 1.35V	2.62 <b>2.60</b>	2.68		V	
					0.01	0.12 <b>0.15</b>	V
		R <sub>L</sub> = 600Ω to 1.35V	2.52 <b>2.50</b>	2.55		V	
					0.05	0.23 <b>0.30</b>	V
V <sub>O(SD)</sub>	Output Voltage in Shutdown			10	200	mV	
I <sub>S</sub>	Supply Current per Channel	On Mode		1.22	1.7 <b>1.9</b>	mA	
		Shutdown Mode		0.12	1.5 <b>2.0</b>	uA	

## 2.7V Electrical Characteristics

Unless otherwise specified, all limits guaranteed for  $V^+ = 2.7V$ ,  $V^- = 0V$ ,  $V_{CM} = 1.35V$  and  $T_A = 25^\circ C$  and  $R_L > 1M\Omega$ . **Boldface** limits apply at the temperature extremes. (Continued)

Symbol	Parameter	Condition	Min (Note 6)	Typ (Note 5)	Max (Note 6)	Units
$A_{VOL}$	Large Signal Voltage Gain	Sourcing $R_L = 10k\Omega$ $V_O = 1.35V$ to $2.3V$	80 <b>76</b>	115		dB
		Sinking $R_L = 10k\Omega$ $V_O = 0.4V$ to $1.35V$	80 <b>76</b>	113		dB
		Sourcing $R_L = 600\Omega$ $V_O = 1.35V$ to $2.2V$	80 <b>76</b>	97		dB
		Sinking $R_L = 600\Omega$ $V_O = 0.5V$ to $1.35V$	80 <b>76</b>	100		dB
$V_{SD}$	Shutdown Pin Voltage Range	On Mode	2.4 to 2.7	2.0 to 2.7		V
		Shutdown Mode	0 to 0.8	0 to 1		V
GBWP	Gain-Bandwidth Product			5		MHz
SR	Slew Rate	(Note 7)		5		V/ $\mu s$
$\phi_m$	Phase Margin			60		Deg
$e_n$	Input Referred Voltage Noise	$f = 1kHz$		20		nV/ $\sqrt{Hz}$
$T_{ON}$	Turn-On Time from Shutdown			2.2	4 <b>4.6</b>	$\mu s$
	Turn-On Time from Shutdown	micro SMD	6 <b>8</b>			$\mu s$

## 5V Electrical Characteristics

Unless otherwise specified, all limits guaranteed for  $V^+ = 5V$ ,  $V^- = 0V$ ,  $V_{CM} = 2.5V$  and  $T_A = 25^\circ C$  and  $R_L > 1M\Omega$ . **Boldface** limits apply at the temperature extremes.

Symbol	Parameter	Condition	Min (Note 6)	Typ (Note 5)	Max (Note 6)	Units	
$V_{OS}$	Input Offset Voltage	$V_{CM} = 0.85V$ and $V_{CM} = 1.85V$	MSOP LLP BL Packages		0.4	3 <b>3.2</b>	mV
			TL Package		3	7 <b>9</b>	
$I_B$	Input Bias Current			5.5	115 <b>130</b>	pA	
CMRR	Common Mode Rejection Ratio	$0V \leq V_{CM} \leq 5V$	50 <b>45</b>	80		dB	
PSRR	Power Supply Rejection Ratio	$2.7V \leq V^+ \leq 5V$ , $V_{CM} = 0.85V$	70 <b>68</b>	90		dB	
		$2.7V \leq V^+ \leq 5V$ , $V_{CM} = 1.85V$	70 <b>68</b>	90		dB	
CMVR	Common Mode Voltage Range	For CMRR $\geq 50dB$		-0.3	-0.2	V	
				5.2	5.3	V	
$I_{SC}$	Output Short Circuit Current	Sourcing $V_O = 0V$	20 <b>18</b>	35		mA	
		Sinking $V_O = 5V$	25 <b>21</b>	50		mA	

## 5V Electrical Characteristics (Continued)

Unless otherwise specified, all limits guaranteed for  $V^+ = 5V$ ,  $V^- = 0V$ ,  $V_{CM} = 2.5V$  and  $T_A = 25^\circ C$  and  $R_L > 1M\Omega$ . **Boldface** limits apply at the temperature extremes.

Symbol	Parameter	Condition	Min (Note 6)	Typ (Note 5)	Max (Note 6)	Units
$V_O$	Output Swing	$R_L = 10k\Omega$ to 2.5V	4.92	4.98		V
			<b>4.90</b>		0.01	0.12
		$R_L = 600\Omega$ to 2.5V	4.82	4.85		V
			<b>4.80</b>		0.05	0.23
				<b>0.30</b>	V	
$V_{O(SD)}$	Output Voltage in Shutdown			10	200	mV
$I_S$	Supply Current per Channel	On Mode		1.17	1.7	mA
		Shutdown Mode		0.12	1.5	<b>2.0</b>
$A_{VOL}$	Large Signal Voltage Gain	Sourcing $R_L = 10k\Omega$ $V_O = 2.5V$ to 4.6V	80	130		dB
		Sinking $R_L = 10k\Omega$ $V_O = 0.4V$ to 2.5V	80	130		dB
		Sourcing $R_L = 600\Omega$ $V_O = 2.5V$ to 4.6V	80	110		dB
		Sinking $R_L = 600\Omega$ $V_O = 0.4V$ to 2.5V	80	107		dB
$V_{SD}$	Shutdown Pin Voltage Range	On Mode	4.5 to 5	3.5 to 5		V
		Shutdown Mode	0 to 0.8	0 to 1.5		V
GBWP	Gain-Bandwidth Product			5		MHz
SR	Slew Rate	(Note 7)		5		V/ $\mu s$
$\phi_m$	Phase Margin			60		Deg
$e_n$	Input Referred Voltage Noise	$f = 1kHz$		20		nV/ $\sqrt{Hz}$
$T_{ON}$	Turn-On Time for Shutdown			1.6	4	$\mu s$
	Turn-On Time for Shutdown	micro SMD	6		<b>4.6</b>	$\mu s$
			<b>8</b>			$\mu s$

**Note 1:** Absolute Maximum Ratings indicate limits beyond which damage to the device may occur. Operating Ratings indicate conditions for which the device is intended to be functional, but specific performance is not guaranteed. For guaranteed specifications and the test conditions, see the Electrical Characteristics.

**Note 2:** Human Body Model is 1.5k $\Omega$  in series with 100pF. Machine Model is 0 $\Omega$  in series with 100pF.

**Note 3:** Shorting circuit output to either  $V^+$  or  $V^-$  will adversely affect reliability.

**Note 4:** The maximum power dissipation is a function of  $T_{J(MAX)}$ ,  $\theta_{JA}$  and  $T_A$ . The maximum allowable power dissipation at any ambient temperature is  $P_D = (T_{J(MAX)} - T_A) / \theta_{JA}$ . All numbers apply for packages soldered directly into a PC board.

**Note 5:** Typical values represent the most likely parametric norm.

**Note 6:** All limits are guaranteed by testing or statistical analysis.

**Note 7:** Number specified is the slower of the positive and negative slew rates.

# Typical Performance Characteristics

25°C.

Unless otherwise specified,  $V_S = +5V$ , single supply,  $T_A =$

Supply Current Per Channel vs. Supply Voltage

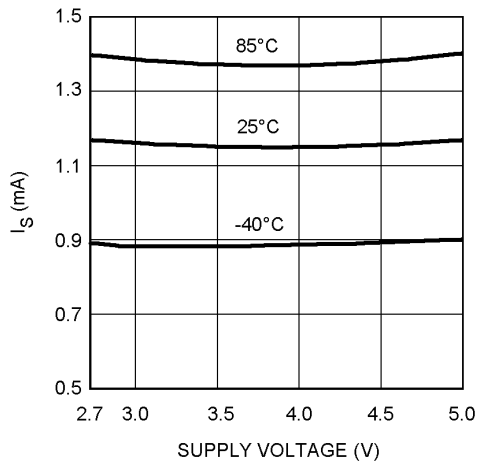

10137001

Supply Current vs. Supply Voltage (Shutdown)

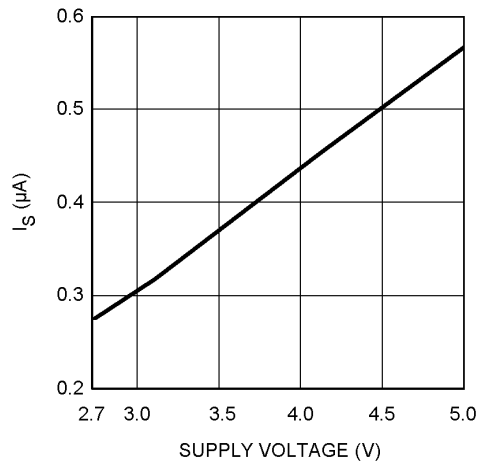

10137002

$V_{OS}$  vs.  $V_{CM}$

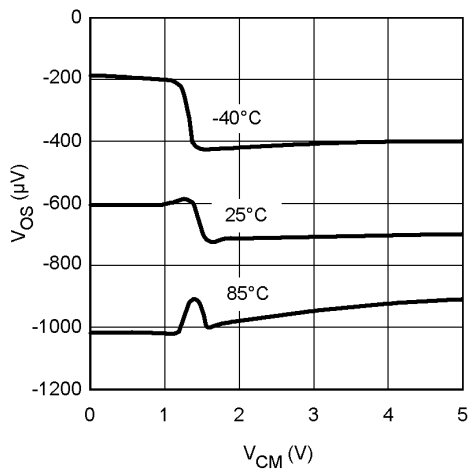

10137003

$I_B$  vs.  $V_{CM}$  Over Temp

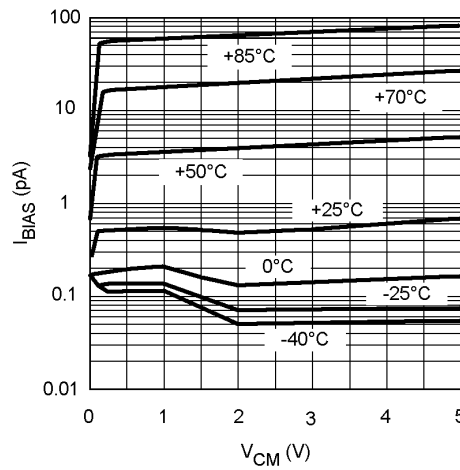

10137005

Output Positive Swing vs. Supply Voltage,  $R_L = 600\Omega$

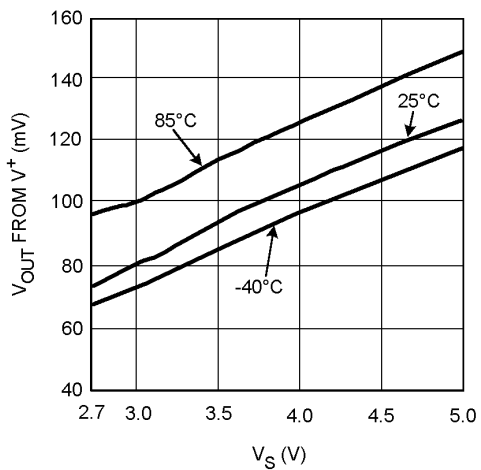

10137006

Output Negative Swing vs. Supply Voltage,  $R_L = 600\Omega$

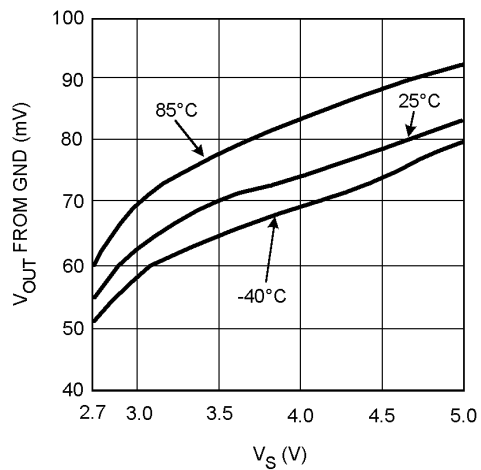

10137007

**Typical Performance Characteristics** Unless otherwise specified,  $V_S = +5V$ , single supply,  $T_A = 25^\circ C$ . (Continued)

**Sourcing Current vs. Output Voltage,  $V_S = 2.7V$**

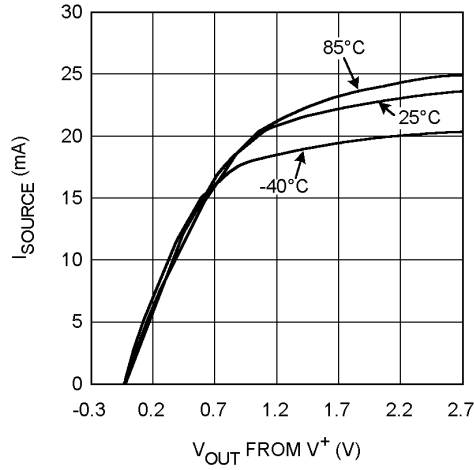

10137008

**Sourcing Current vs. Output Voltage,  $V_S = 5V$**

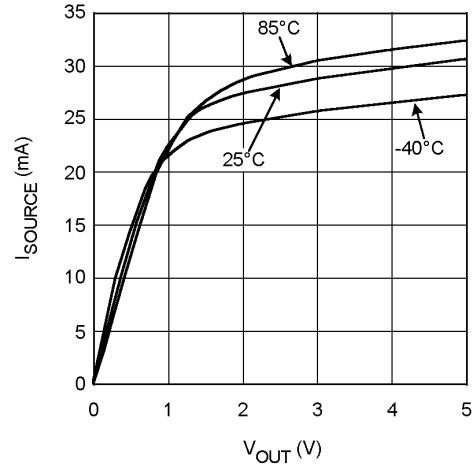

10137010

**Sinking Current vs. Output Voltage,  $V_S = 2.7V$**

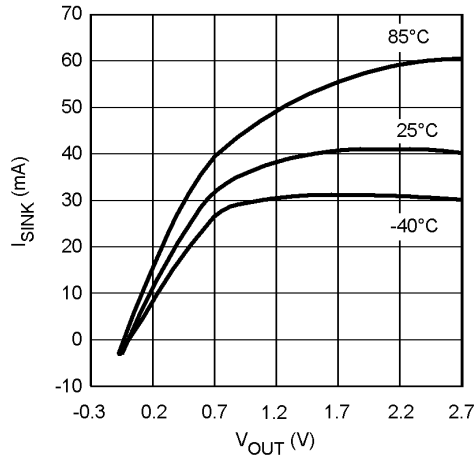

10137009

**Sinking Current vs. Output Voltage,  $V_S = 5V$**

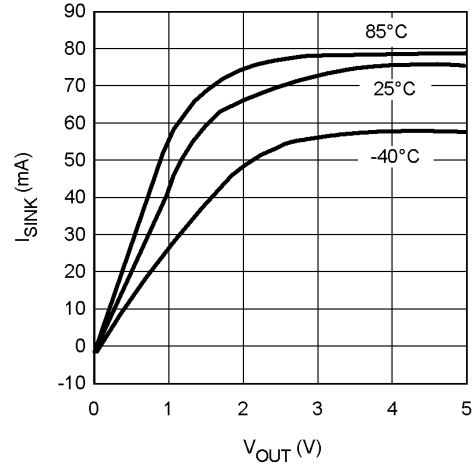

10137011

**PSRR vs. Frequency  $V_S = 2.7V$**

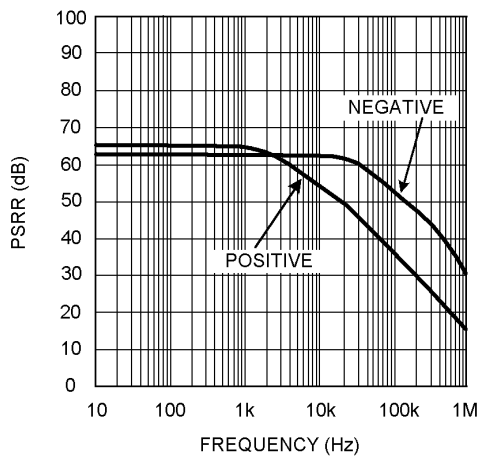

10137018

**PSRR vs. Frequency  $V_S = 5V$**

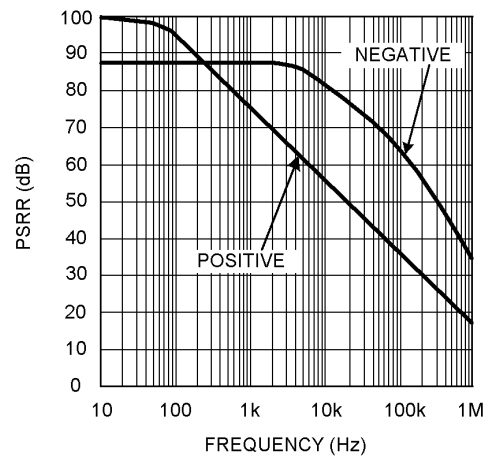

10137019

**Typical Performance Characteristics** Unless otherwise specified,  $V_S = +5V$ , single supply,  $T_A = 25^\circ C$ . (Continued)

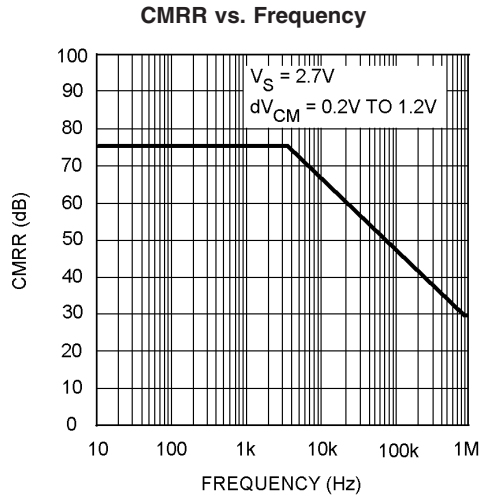

10137016

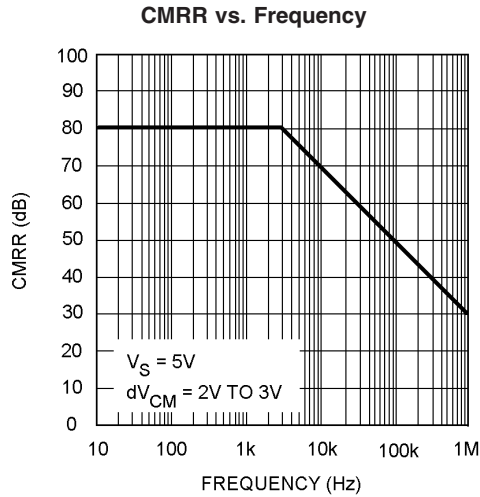

10137017

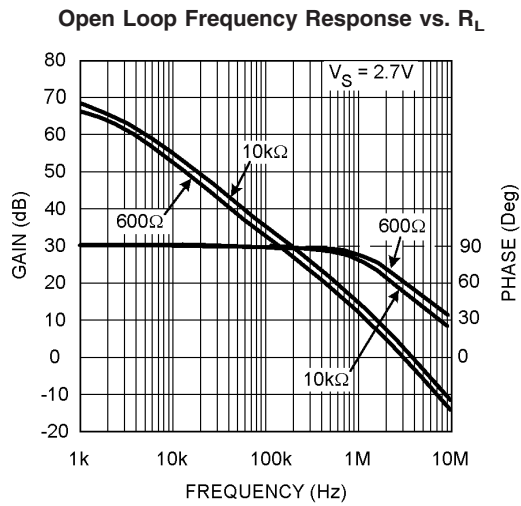

10137012

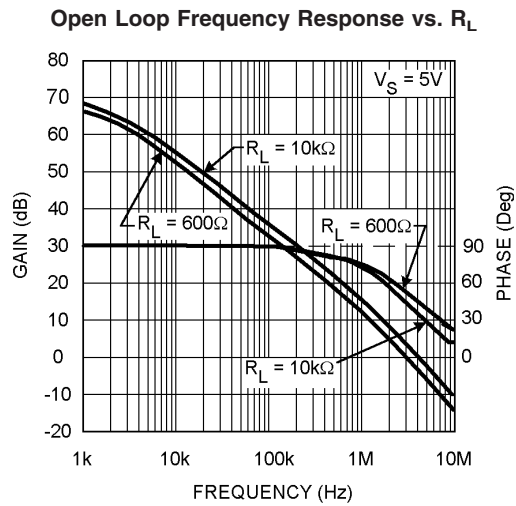

10137014

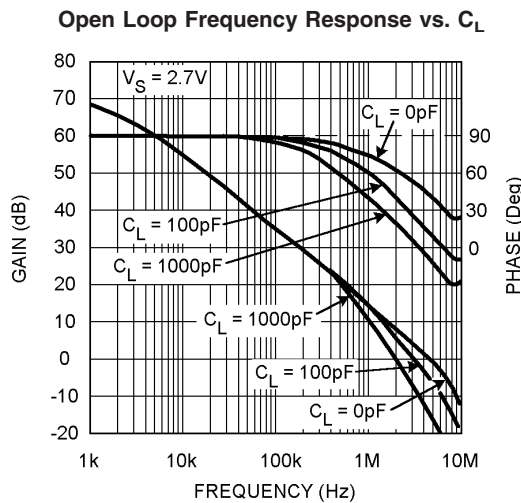

10137013

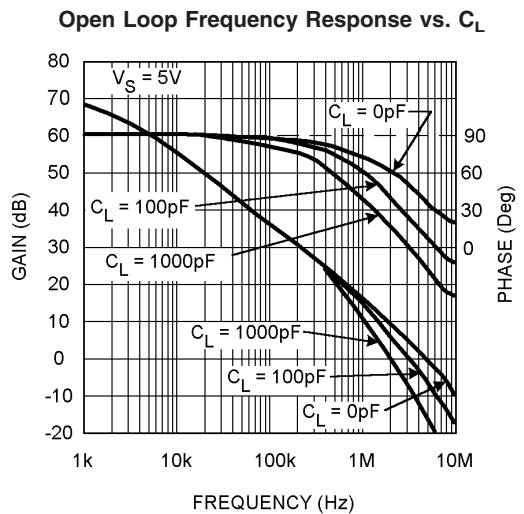

10137015

**Typical Performance Characteristics** Unless otherwise specified,  $V_S = +5V$ , single supply,  $T_A = 25^\circ C$ . (Continued)

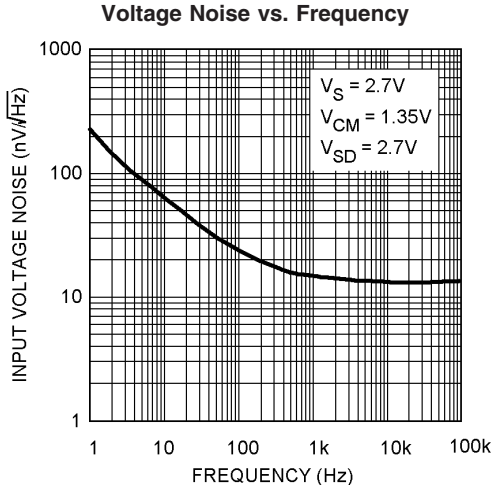

10137020

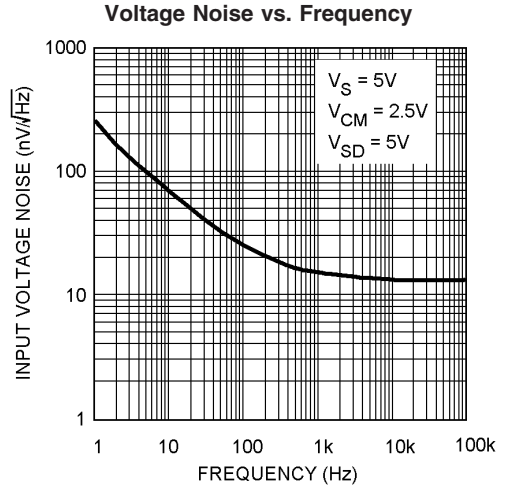

10137021

**Non-Inverting Large Signal Pulse Response,  $V_S = 2.7V$**

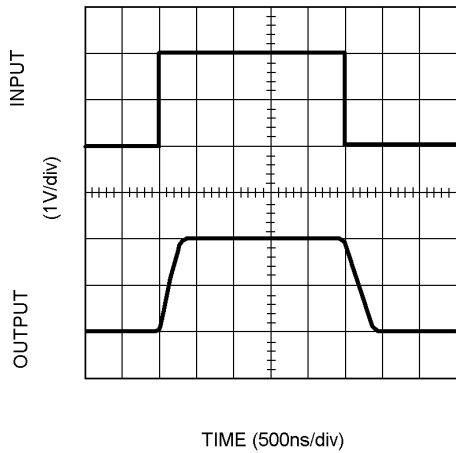

10137022

**Non-Inverting Large Signal Pulse Response,  $V_S = 5V$**

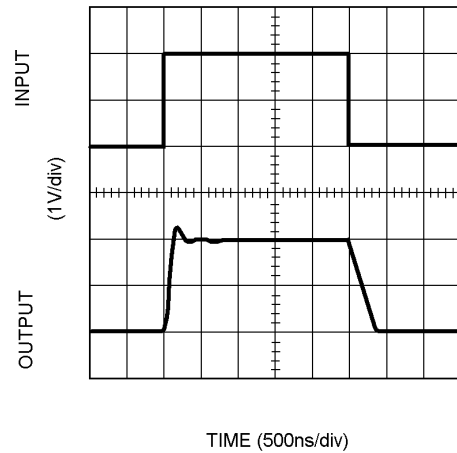

10137024

**Non-Inverting Small Signal Pulse Response,  $V_S = 2.7V$**

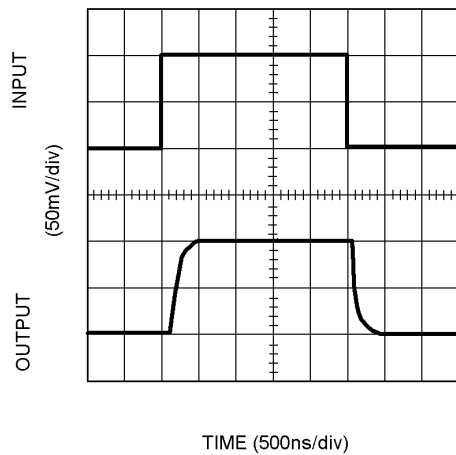

10137023

**Non-Inverting Small Signal Pulse Response,  $V_S = 5V$**

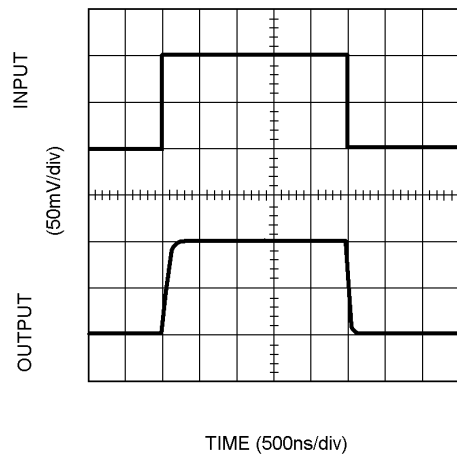

10137025



**Typical Performance Characteristics** Unless otherwise specified,  $V_S = +5V$ , single supply,  $T_A = 25^\circ C$ . (Continued)

**Inverting Large Signal Pulse Response,  $V_S = 2.7V$**

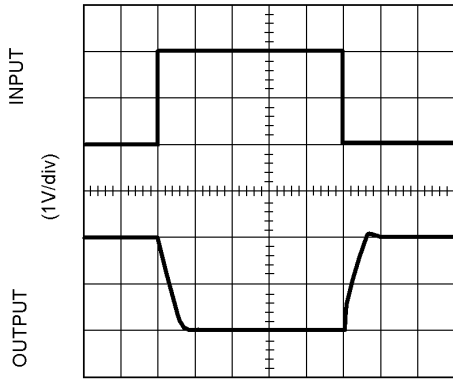

TIME (500ns/div)

10137026

**Inverting Large Signal Pulse Response,  $V_S = 5V$**

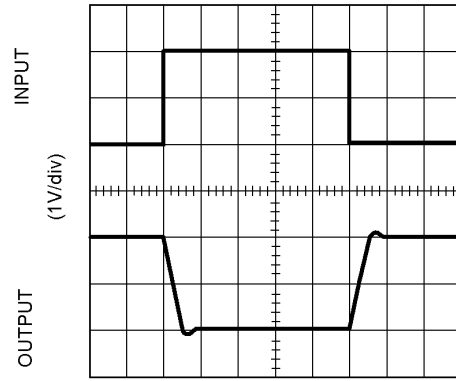

TIME (500ns/div)

10137028

**Inverting Small Signal Pulse Response,  $V_S = 2.7V$**

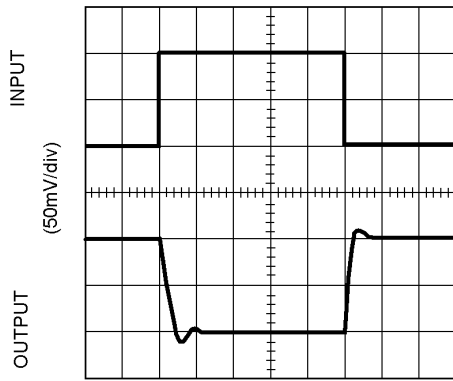

TIME (500ns/div)

10137027

**Inverting Small Signal Pulse Response  $V_S = 5V$**

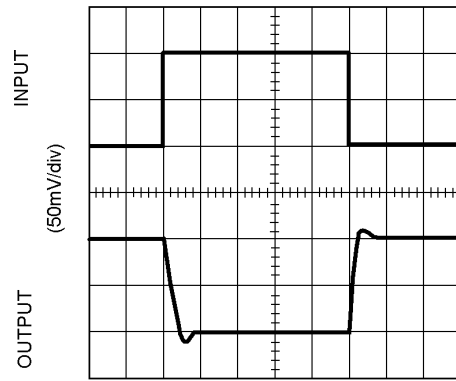

TIME (500ns/div)

10137029

**Turn on Time Response  $V_S = 5V$**

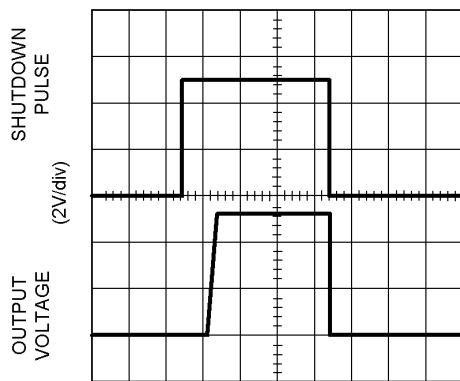

TIME (2µs/div)

10137030

**Input Common Mode Capacitance vs.  $V_{CM}$   $V_S = 5V$**

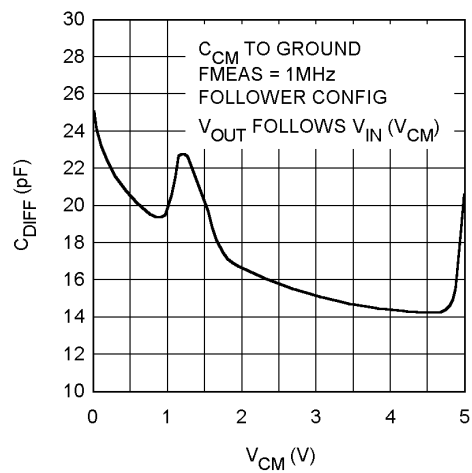

10137004

## Application Information

### Theory of Operation

The LMV712 dual op amp is derived from the LMV711 single op amp. *Figure 1* contains a simplified schematic of one channel of the LMV712.

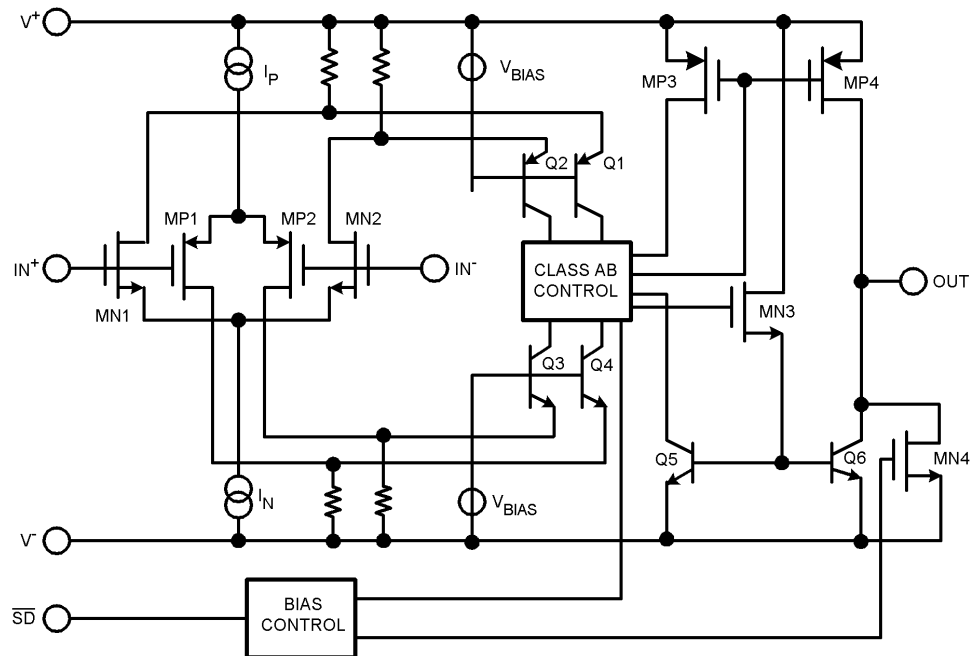

10137031

FIGURE 1.

Rail-to-Rail input is achieved by using in parallel, one NMOS differential pair (MN1 and MN2) and one PMOS differential pair (MP1 and MP2). When the common mode input voltage ( $V_{CM}$ ) is near  $V^+$ , the NMOS pair is on and the PMOS pair is off. When  $V_{CM}$  is near  $V^-$ , the NMOS pair is off and the PMOS pair is on. When  $V_{CM}$  is between  $V^+$  and  $V^-$ , internal logic decides how much current each differential pair will get. This special logic ensures stable and low distortion amplifier operation within the entire common mode voltage range.

Because both input stages have their own offset voltage ( $V_{OS}$ ) characteristic, the offset voltage of the LMV712 becomes a function of  $V_{CM}$ .  $V_{OS}$  has a crossover point at 1.4V above  $V^-$ . Refer to the " $V_{OS}$  vs.  $V_{CM}$ " curve in the Typical Performance Characteristics section. Caution should be taken in situations where input signal amplitude is comparable to  $V_{OS}$  value and/or the design requires high accuracy. In these situations, it is necessary for the input signal to avoid the crossover point.

The current coming out of the input differential pairs gets mirrored through two folded cascode stages (Q1, Q2, Q3, Q4) into the "class AB control" block. This circuitry generates voltage gain, defines the op amp's dominant pole and limits the maximum current flowing at the output stage. MN3 introduces a voltage level shift and acts as a high impedance to low impedance buffer.

The output stage is composed of a PMOS and a NPN transistor in a common source/emitter configuration, delivering a rail-to-rail output excursion.

The MN4 transistor ensures that the LMV712 output remains near  $V^-$  when the amplifier is in shutdown mode.

#### Shutdown Pin

The LMV712 offers independent shutdown pins for the dual amplifiers. When the shutdown pin is tied low, the respective amplifier shuts down and the supply current is reduced to less than 1 $\mu$ A. In shutdown mode, the amplifier's output level stays at  $V^-$ . In a 2.7V operation, when a voltage between 1.5V to 2.7V is applied to the shutdown pin, the amplifier is enabled. As the amplifier is coming out of the shutdown mode, the output waveform ramps up without any glitch. This is demonstrated in *Figure 2*.

## Application Information (Continued)

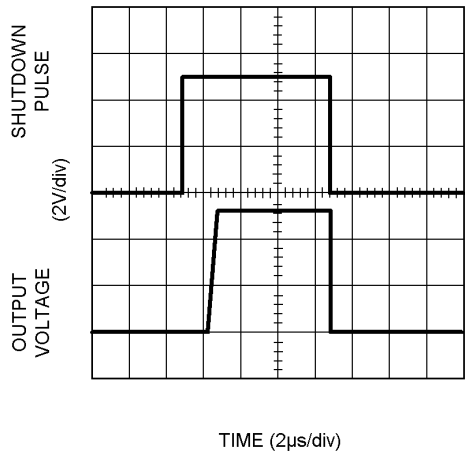

FIGURE 2.

A glitch-free output waveform is highly desirable in many applications, one of which is power amplifier control loops. In this application, the LMV712 is used to drive the power amplifier's power control. If the LMV712 did not have a smooth output ramp during turn on, it would directly cause the power amplifier to produce a glitch at its output. This adversely affects the performance of the system.

To enable the amplifier, the shutdown pin must be pulled high. It should not be left floating in the event that any leakage current may inadvertently turn off the amplifier.

### Printed Circuit Board Consideration

To properly bypass the power supply, several locations on a printed circuit board need to be considered. A  $6.8\mu\text{F}$  or greater tantalum capacitor should be placed at the point where the power supply for the amplifier is introduced onto the board. Another  $0.1\mu\text{F}$  ceramic capacitor should be placed as close as possible to the power supply pin of the amplifier. If the amplifier is operated in a single power supply, only the  $V^+$  pin needs to be bypassed with a  $0.1\mu\text{F}$  capacitor. If the amplifier is operated in a dual power supply, both  $V^+$  and  $V^-$  pins need to be bypassed.

It is good practice to use a ground plane on a printed circuit board to provide all components with a low inductive ground connection.

Surface mount components in 0805 size or smaller are recommended in the LMV712 application circuits. Designers can take advantage of the micro SMD, MSOP and LLP miniature sizes to condense board layout in order to save space and reduce stray capacitance.

### Capacitive Load Tolerance

The LMV712 can directly drive  $200\text{pF}$  in unity-gain without oscillation. The unity-gain follower is the most sensitive configuration to capacitive loading. Direct capacitive loading reduces the phase margin of amplifiers. The combination of the amplifier's output impedance and the capacitive load

induces phase lag. This results in either an under-damped pulse response or oscillation. To drive a heavier capacitive load, *Figure 3* can be used.

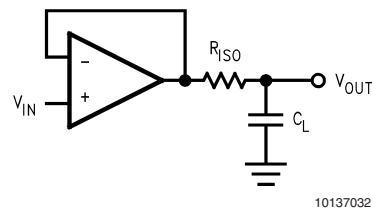

FIGURE 3.

In *Figure 3*, the isolation resistor  $R_{\text{ISO}}$  and the load capacitor  $C_L$  form a pole to increase stability by adding more phase margin to the overall system. The desired performance depends on the value of  $R_{\text{ISO}}$ . The bigger the  $R_{\text{ISO}}$  resistor value, the more stable  $V_{\text{OUT}}$  will be. But the DC accuracy is degraded when the  $R_{\text{ISO}}$  gets bigger. If there were a load resistor in *Figure 3*, the output voltage would be divided by  $R_{\text{ISO}}$  and the load resistor.

The circuit in *Figure 4* is an improvement to the one in *Figure 3* because it provides DC accuracy as well as AC stability. In this circuit,  $R_F$  provides the DC accuracy by using feed-forward techniques to connect  $V_{\text{IN}}$  to  $R_L$ .  $C_F$  and  $R_{\text{ISO}}$  serve to counteract the loss of phase margin by feeding the high frequency component of the output signal back to the amplifier's inverting input, thereby preserving phase margin in the overall feedback loop. Increased capacitive drive is possible by increasing the value of  $C_F$ . This in turn will slow down the pulse response.

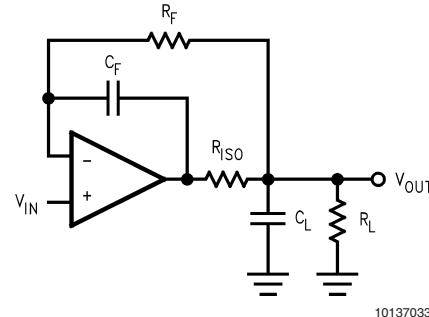
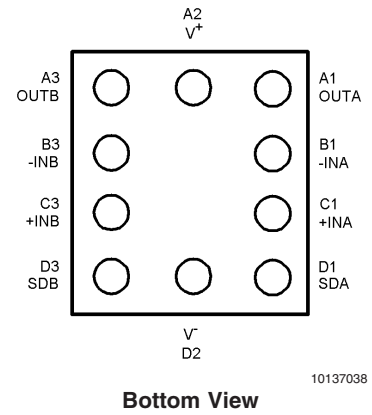
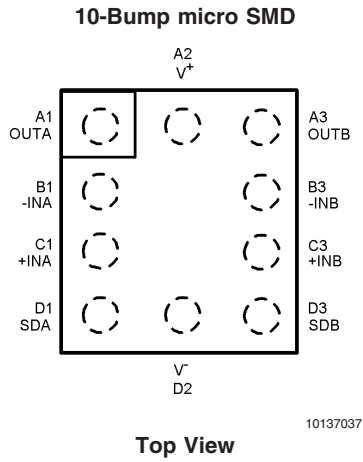
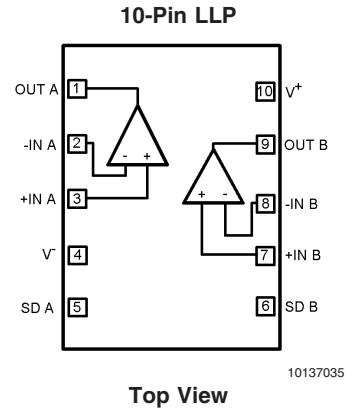
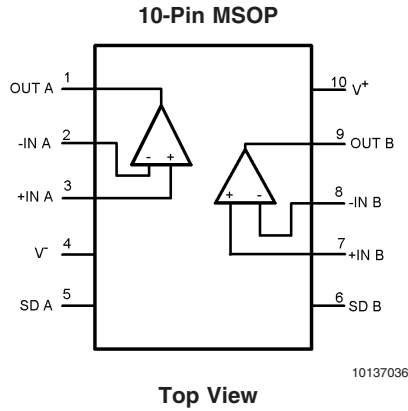

FIGURE 4.

### Latchup

CMOS devices tend to be susceptible to latchup due to their internal parasitic SCR (silicon controlled rectifier) effects. The input and output pins look similar to the gate of the SCR. There is a minimum current required to trigger the SCR gate lead. The LMV712 is designed to withstand  $150\text{mA}$  surge current on all the pins. Some resistive method should be used to isolate any capacitance from supplying excess current to the pins. In addition, like an SCR, there is a minimum holding current for any latchup mode. Limiting current to the supply pins will also inhibit latchup susceptibility.

## Connection Diagrams



## Ordering Information

Package	Part Number	Package Marking	Transport Media	NSC Drawing
10-Pin MSOP	LMV712MM	A61	1k Units Tape and Reel	MUB10A
	LMV712MMX		3.5k Units Tape and Reel	
10-Pin LLP	LMV712LD	A62	1k Units Tape and Reel	LDA10A
	LMV712LDX		4.5k Units Tape and Reel	
10-Bump micro SMD (PB)	LMV712BL	A76A	250 Units Tape and Reel	BLP10AAB 0.945mm thick
	LMV712BLX		3k Units Tape and Reel	
10-Bump micro SMD (NOPB)	LMV712TL	AU2A	250 Units Tape and Reel	TLP10BBA 0.600mm thick
	LMV712TLX		3k Units Tape and Reel	

**Physical Dimensions** inches (millimeters) unless otherwise noted

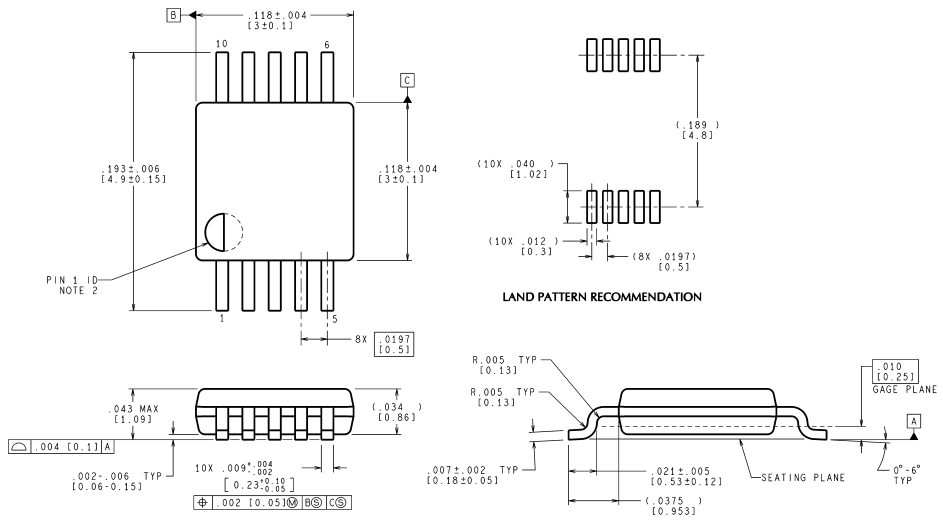

CONTROLLING DIMENSION IS INCH  
VALUES IN [ ] ARE MILLIMETERS  
DIMENSIONS IN ( ) FOR REFERENCE ONLY

MUB10A (Rev B)

**10-Pin MSOP  
NS Package Number MUB10A**

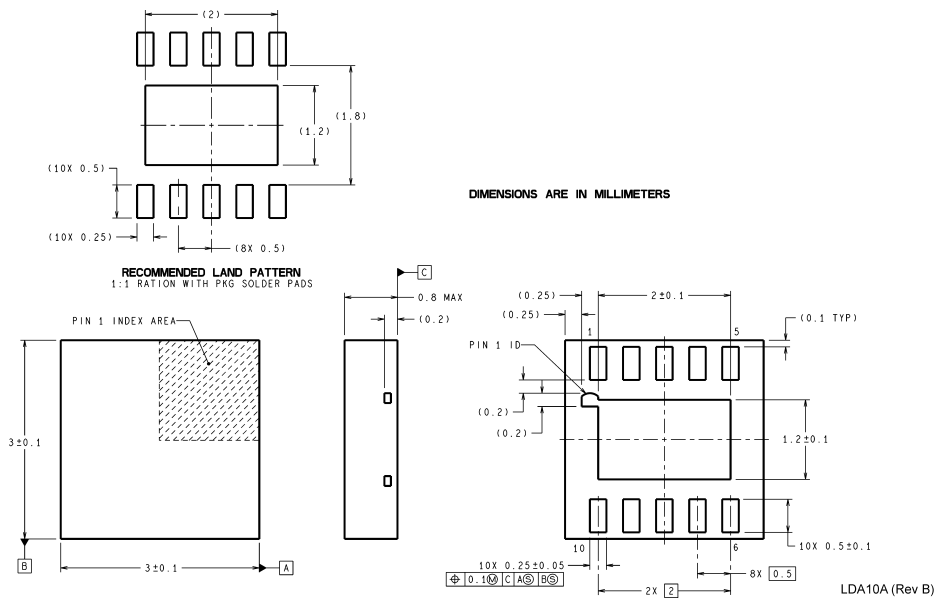

DIMENSIONS ARE IN MILLIMETERS

LDA10A (Rev B)

**10-Pin LLP  
NS Package Number LDA10A**

**Physical Dimensions** inches (millimeters) unless otherwise noted (Continued)

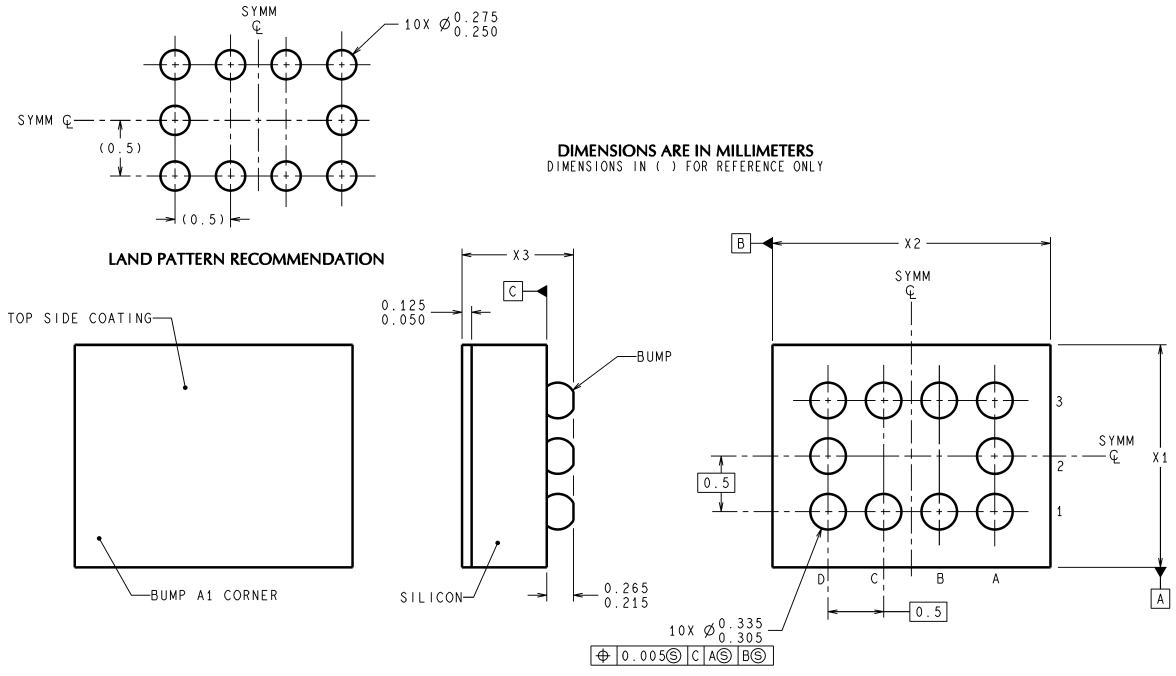

BLP10XXX (Rev D)

NOTES: UNLESS OTHERWISE SPECIFIED

1. EPOXY COATING
2. FOR SOLDER BUMP COMPOSITION. SEE "SOLDER INFORMATION" IN THE PACKAGING SECTION OF THE NATIONAL SEMICONDUCTOR WEB PAGE ([www.national.com](http://www.national.com))
3. RECOMMEND NON-SOLDER MASK DEFINED LANDING PAD.
4. PIN A1 IS ESTABLISHED BY LOWER LEFT CORNER WITH RESPECT TO TEXT ORIENTATION.
5. XXX IN DRAWING NUMBER REPRESENTS PACKAGE SIZE VARIATION WHERE X1 IS PACKAGE WIDTH, X2 IS PACKAGE LENGTH AND X3 IS PACKAGE HEIGHT.
6. REFERENCE JEDEC REGISTRATION MO-211, VARIATION BD.

**10-Bump micro SMD**  
**NS Package Number BLP10AAB**  
**X1 = 1.514 ± 0.030mm    X2 = 1.996 ± 0.030mm    X3 = 0.945 ± 0.100mm**

**Physical Dimensions** inches (millimeters) unless otherwise noted (Continued)

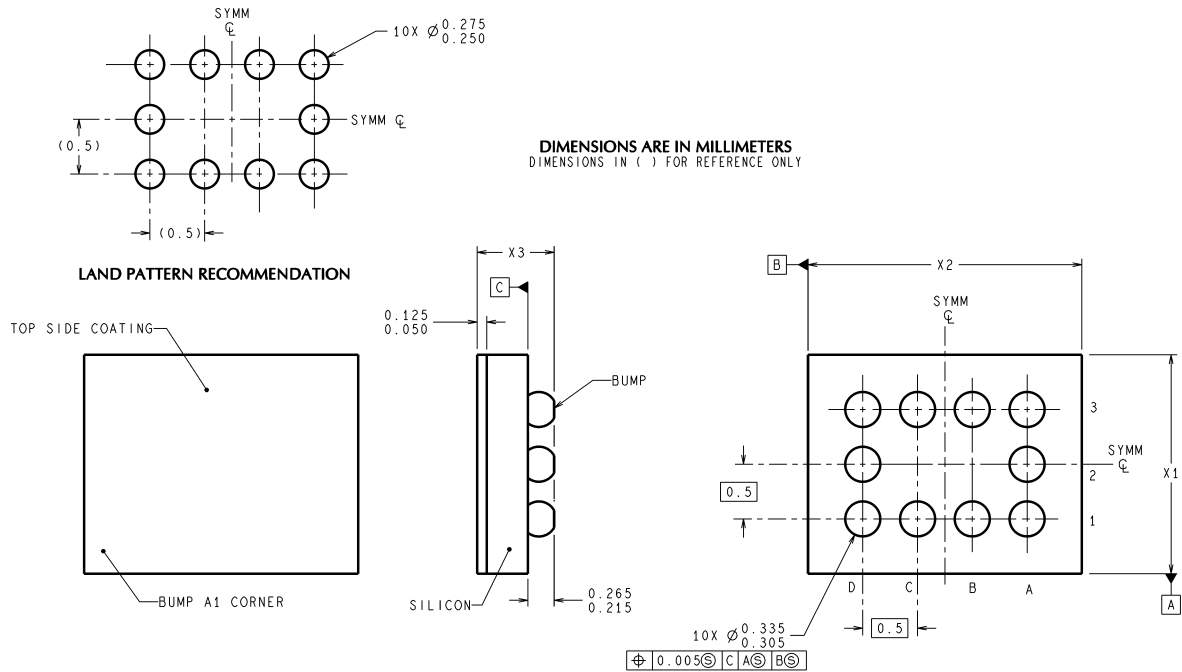

NOTES: UNLESS OTHERWISE SPECIFIED

1. EPOXY COATING
2. FOR SOLDER BUMP COMPOSITION. SEE "SOLDER INFORMATION" IN THE PACKAGING SECTION OF THE NATIONAL SEMICONDUCTOR WEB PAGE ([www.national.com](http://www.national.com))
3. RECOMMEND NON-SOLDER MASK DEFINED LANDING PAD.
4. PIN A1 IS ESTABLISHED BY LOWER LEFT CORNER WITH RESPECT TO TEXT ORIENTATION.
5. XXX IN DRAWING NUMBER REPRESENTS PACKAGE SIZE VARIATION WHERE X1 IS PACKAGE WIDTH, X2 IS PACKAGE LENGTH AND X3 IS PACKAGE HEIGHT.
6. REFERENCE JEDEC REGISTRATION MO-211, VARIATION BD.

**10-Bump micro SMD**  
**NS Package Number TLP10BBA**  
**X1 = 1.539 ±0.030mm    X2 = 2.022 ±0.030mm    X3 = 0.600 ±0.075mm**

National does not assume any responsibility for use of any circuitry described, no circuit patent licenses are implied and National reserves the right at any time without notice to change said circuitry and specifications.

For the most current product information visit us at [www.national.com](http://www.national.com).

**LIFE SUPPORT POLICY**

NATIONAL'S PRODUCTS ARE NOT AUTHORIZED FOR USE AS CRITICAL COMPONENTS IN LIFE SUPPORT DEVICES OR SYSTEMS WITHOUT THE EXPRESS WRITTEN APPROVAL OF THE PRESIDENT AND GENERAL COUNSEL OF NATIONAL SEMICONDUCTOR CORPORATION. As used herein:

1. Life support devices or systems are devices or systems which, (a) are intended for surgical implant into the body, or (b) support or sustain life, and whose failure to perform when properly used in accordance with instructions for use provided in the labeling, can be reasonably expected to result in a significant injury to the user.
2. A critical component is any component of a life support device or system whose failure to perform can be reasonably expected to cause the failure of the life support device or system, or to affect its safety or effectiveness.

**BANNED SUBSTANCE COMPLIANCE**

National Semiconductor manufactures products and uses packing materials that meet the provisions of the Customer Products Stewardship Specification (CSP-9-111C2) and the Banned Substances and Materials of Interest Specification (CSP-9-111S2) and contain no "Banned Substances" as defined in CSP-9-111S2.

Leadfree products are RoHS compliant.



**National Semiconductor**  
**Americas Customer Support Center**  
Email: [new.feedback@nsc.com](mailto:new.feedback@nsc.com)  
Tel: 1-800-272-9959

**National Semiconductor**  
**Europe Customer Support Center**  
Fax: +49 (0) 180-530 85 86  
Email: [europe.support@nsc.com](mailto:europe.support@nsc.com)  
Deutsch Tel: +49 (0) 69 9508 6208  
English Tel: +44 (0) 870 24 0 2171  
Français Tel: +33 (0) 1 41 91 8790

**National Semiconductor**  
**Asia Pacific Customer Support Center**  
Email: [ap.support@nsc.com](mailto:ap.support@nsc.com)

**National Semiconductor**  
**Japan Customer Support Center**  
Fax: 81-3-5639-7507  
Email: [jpn.feedback@nsc.com](mailto:jpn.feedback@nsc.com)

# LMV712 Low Power, Low Noise, High Output, RRIO Dual Operational Amplifier with Independent Shutdown

[www.national.com](http://www.national.com)

Tel: 81-3-5639-7560