

Chip Monolithic Ceramic Capacitors

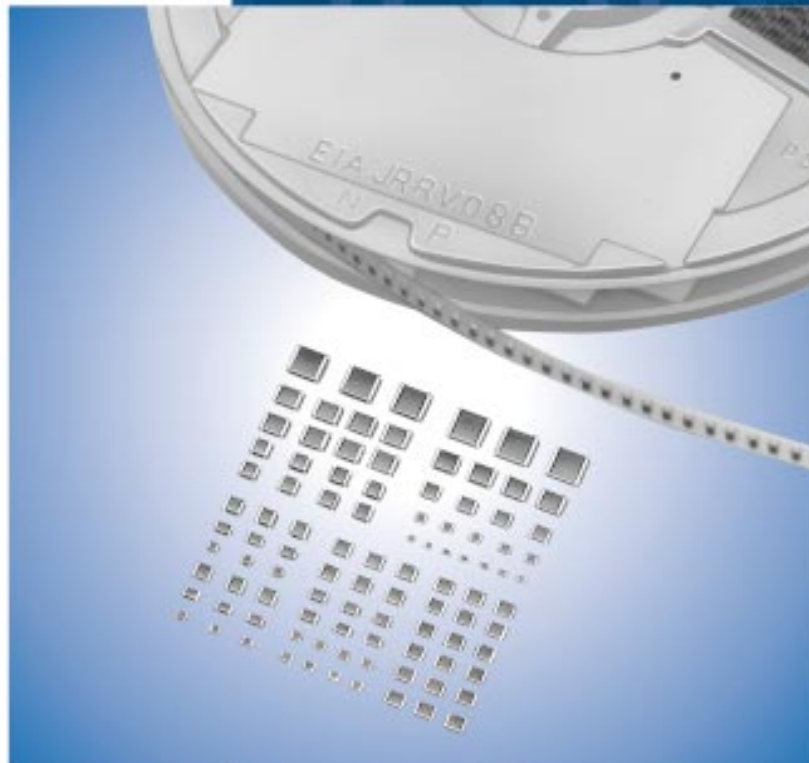

Cat.No.C02E-15

muRata *Innovator
in Electronics*
Murata
Manufacturing Co., Ltd.

CONTENTS

Part Numbering	_____	2
Selection Guide	_____	7
1 for General Purpose GRM Series	_____	8
1 Specifications and Test Methods	_____	51
●GRM Series Data	_____	60
2 Capacitor Array GNM Series	_____	63
2 Specifications and Test Methods	_____	68
3 Low ESL LLL/LLA/LLM Series	_____	74
3 Specifications and Test Methods	_____	81
4 High-Q Type GJM Series	_____	85
4 Specifications and Test Methods	_____	95
5 High Frequency GQM Series	_____	98
5 Specifications and Test Methods	_____	105
●GQM Series Data	_____	108
6 High Frequency Type ERB Series	_____	109
6 Specifications and Test Methods	_____	116
●ERB Series Data	_____	119
7 Monolithic Microchip GMA Series	_____	121
7 Specifications and Test Methods	_____	123
8 for Bonding GMD Series	_____	127
8 Specifications and Test Methods	_____	132
Package	_____	136
⚠Caution	_____	140
Notice	_____	152
Reference Data	_____	159
9 Medium Voltage Low Dissipation Factor	_____	166
10 Medium Voltage High Capacitance for General Use	_____	171
11 Only for LCD Backlight Inverter Circuit	_____	176
12 Only for Information Devices	_____	179

13	Only for Camera Flash Circuit	183
14	AC250V (r.m.s.) Type (Which Meet Japanese Law)	187
15	Safety Standard Certified Type GC (UL, IEC60384-14 Class X1/Y2)	191
16	Safety Standard Certified Type GD (IEC60384-14 Class Y3)	192
17	Safety Standard Certified Type GF (IEC60384-14 Class Y2, X1/Y2)	193
18	Safety Standard Certified Type GB (IEC60384-14 Class X2)	195
	GA3 Series Specifications and Test Methods	196
	GRM/GR4/GR7/GA2/GA3 Series Data (Typical Example)	200
	Package	203
	⚠Caution	206
	Notice	214
	ISO 9001 Certifications	217

● Please refer to "Specifications and Test Methods" at the end of each chapter of **9** - **14** .

for EU RoHS Compliant

- All the products in this catalog comply with EU RoHS.
- EU RoHS is "the European Directive 2002/95/EC on the Restriction of the Use of Certain Hazardous Substances in Electrical and Electronic Equipment".
- For more details, please refer to our website 'Murata's Approach for EU RoHS' (<http://www.murata.com/info/rohs.html>).

Please check MURATA home page (<http://www.murata.com/index.html>) in case you can not find the part number on the catalog.

● Part Numbering

Chip Monolithic Ceramic Capacitors

(Part Number)

GR	M	18	8	B1	1H	102	K	A01	D
①	②	③	④	⑤	⑥	⑦	⑧	⑨	⑩

① Product ID

② Series

Product ID	Code	Series
GR	M	Tin Plated Layer
	4	Only for Information Devices / Tip & Ring
	7	Only for Camera Flash Circuit
ER	B	High Frequency Type
GQ	M	High Frequency for Flow/Reflow Soldering
GM	A	Monolithic Microchip
	D	for Bonding
GN	M	Capacitor Array
LL	L	Low ESL Wide Width Type
	A	Eight-termination Low ESL Type
	M	Ten-termination Low ESL Type
GJ	M	High Frequency Low Loss Type
GA	2	for AC250V (r.m.s.)
	3	Safety Standard Certified Type

③ Dimension (L×W)

Code	Dimension (L×W)	EIA
02	0.4×0.2mm	01005
03	0.6×0.3mm	0201
05	0.5×0.5mm	0202
08	0.8×0.8mm	0303
0D	0.38×0.38mm	015015
0M	0.9×0.6mm	0302
11	1.25×1.0mm	0504
15	1.0×0.5mm	0402
18	1.6×0.8mm	0603
1M	1.37×1.0mm	0504
21	2.0×1.25mm	0805
22	2.8×2.8mm	1111
31	3.2×1.6mm	1206
32	3.2×2.5mm	1210
42	4.5×2.0mm	1808
43	4.5×3.2mm	1812
52	5.7×2.8mm	2211
55	5.7×5.0mm	2220

④ Dimension (T)

Code	Dimension (T)
2	0.2mm
2	2-elements (Array Type)
3	0.3mm
4	4-elements (Array Type)
5	0.5mm
6	0.6mm
7	0.7mm
8	0.8mm
9	0.85mm
A	1.0mm
B	1.25mm
C	1.6mm
D	2.0mm
E	2.5mm
F	3.2mm
M	1.15mm
N	1.35mm
Q	1.5mm
R	1.8mm
S	2.8mm
X	Depends on individual standards.

With the array type GNM series, "Dimension(T)" indicates the number of elements.

Continued on the following page.

Continued from the preceding page.

⑤ Temperature Characteristics

Temperature Characteristic Codes			Temperature Characteristics			Operating Temperature Range
Code	Public STD Code		Reference Temperature	Temperature Range	Capacitance Change or Temperature Coefficient	
1X	SL *1	JIS	20°C	20 to 85°C	+350 to -1000ppm/°C	-55 to 125°C
2C	CH *1	JIS	20°C	20 to 125°C	0±60ppm/°C	-55 to 125°C
2P	PH *1	JIS	20°C	20 to 85°C	-150±60ppm/°C	-25 to 85°C
2R	RH *1	JIS	20°C	20 to 85°C	-220±60ppm/°C	-25 to 85°C
2S	SH *1	JIS	20°C	20 to 85°C	-330±60ppm/°C	-25 to 85°C
2T	TH *1	JIS	20°C	20 to 85°C	-470±60ppm/°C	-25 to 85°C
3C	CJ *1	JIS	20°C	20 to 125°C	0±120ppm/°C	-55 to 125°C
3P	PJ *1	JIS	20°C	20 to 85°C	-150±120ppm/°C	-25 to 85°C
3R	RJ *1	JIS	20°C	20 to 85°C	-220±120ppm/°C	-25 to 85°C
3S	SJ *1	JIS	20°C	20 to 85°C	-330±120ppm/°C	-25 to 85°C
3T	TJ *1	JIS	20°C	20 to 85°C	-470±120ppm/°C	-25 to 85°C
3U	UJ *1	JIS	20°C	20 to 85°C	-750±120ppm/°C	-25 to 85°C
4C	CK *1	JIS	20°C	20 to 125°C	0±250ppm/°C	-55 to 125°C
5C	C0G *1	EIA	25°C	25 to 125°C	0±30ppm/°C	-55 to 125°C
5G	X8G *1	EIA	25°C	25 to 150°C	0±30ppm/°C	-55 to 150°C
6C	C0H *1	EIA	25°C	25 to 125°C	0±60ppm/°C	-55 to 125°C
6P	P2H *1	EIA	25°C	25 to 85°C	-150±60ppm/°C	-55 to 125°C
6R	R2H *1	EIA	25°C	25 to 85°C	-220±60ppm/°C	-55 to 125°C
6S	S2H *1	EIA	25°C	25 to 85°C	-330±60ppm/°C	-55 to 125°C
6T	T2H *1	EIA	25°C	25 to 85°C	-470±60ppm/°C	-55 to 125°C
7U	U2J *1	EIA	25°C	25 to 125°C *6	-750±120ppm/°C	-55 to 125°C
B1	B *2	JIS	20°C	-25 to 85°C	±10%	-25 to 85°C
B3	B	JIS	20°C	-25 to 85°C	±10%	-25 to 85°C
C7	X7S	EIA	25°C	-55 to 125°C	±22%	-55 to 125°C
C8	X6S	EIA	25°C	-55 to 105°C	±22%	-55 to 105°C
D7	X7T	EIA	25°C	-55 to 125°C	+22, -33%	-55 to 125°C
D8	X6T	EIA	25°C	-55 to 105°C	+22, -33%	-55 to 105°C
E7	X7U	EIA	25°C	-55 to 125°C	+22, -56%	-55 to 125°C
F1	F *2	JIS	20°C	-25 to 85°C	+30, -80%	-25 to 85°C
F5	Y5V	EIA	25°C	-30 to 85°C	+22, -82%	-30 to 85°C
L8	X8L	*3	25°C	-55 to 150°C	+15, -40%	-55 to 150°C
R1	R *2	JIS	20°C	-55 to 125°C	±15%	-55 to 125°C
R3	R	JIS	20°C	-55 to 125°C	±15%	-55 to 125°C
R6	X5R	EIA	25°C	-55 to 85°C	±15%	-55 to 85°C
R7	X7R	EIA	25°C	-55 to 125°C	±15%	-55 to 125°C
R9	X8R	EIA	25°C	-55 to 150°C	±15%	-55 to 150°C
W0	-	-	25°C	-55 to 125°C	±10% *4	-55 to 125°C
					+22, -33% *5	

*1 Please refer to table for Capacitance Change under reference temperature.

*2 Capacitance change is specified with 50% rated voltage applied.

*3 Murata Temperature Characteristic Code.

*4 Apply DC350V bias.

*5 No DC bias.

*6 Rated Voltage 100Vdc max : 25 to 85°C

Continued on the following page. ↗

Please check MURATA home page (<http://www.murata.com/index.html>) in case you can not find the part number on the catalog.

☐ Continued from the preceding page.

●Capacitance Change from each temperature

JIS Code

Murata Code	Capacitance Change from 20°C (%)					
	-55°C		-25°C		-10°C	
	Max.	Min.	Max.	Min.	Max.	Min.
1X	-	-	-	-	-	-
2C	0.82	-0.45	0.49	-0.27	0.33	-0.18
2P	-	-	1.32	0.41	0.88	0.27
2R	-	-	1.70	0.72	1.13	0.48
2S	-	-	2.30	1.22	1.54	0.81
2T	-	-	3.07	1.85	2.05	1.23
3C	1.37	-0.90	0.82	-0.54	0.55	-0.36
3P	-	-	1.65	0.14	1.10	0.09
3R	-	-	2.03	0.45	1.35	0.30
3S	-	-	2.63	0.95	1.76	0.63
3T	-	-	3.40	1.58	2.27	1.05
3U	-	-	4.94	2.84	3.29	1.89
4C	2.56	-1.88	1.54	-1.13	1.02	-0.75

EIA Code

Murata Code	Capacitance Change from 25°C (%)					
	-55°C		-30°C		-10°C	
	Max.	Min.	Max.	Min.	Max.	Min.
5C/5G	0.58	-0.24	0.40	-0.17	0.25	-0.11
6C	0.87	-0.48	0.59	-0.33	0.38	-0.21
6P	2.33	0.72	1.61	0.50	1.02	0.32
6R	3.02	1.28	2.08	0.88	1.32	0.56
6S	4.09	2.16	2.81	1.49	1.79	0.95
6T	5.46	3.28	3.75	2.26	2.39	1.44
7U	8.78	5.04	6.04	3.47	3.84	2.21

Continued on the following page. ☐

Please check MURATA home page (<http://www.murata.com/index.html>) in case you can not find the part number on the catalog.

Continued from the preceding page.

⑥ Rated Voltage

Code	Rated Voltage
0E	DC2.5V
0G	DC4V
0J	DC6.3V
1A	DC10V
1C	DC16V
1E	DC25V
YA	DC35V
1H	DC50V
2A	DC100V
2D	DC200V
2E	DC250V
YD	DC300V
2H	DC500V
2J	DC630V
3A	DC1kV
3D	DC2kV
3F	DC3.15kV
BB	DC350V (for Camera Flash Circuit)
E2	AC250V
GB	X2; AC250V (Safety Standard Certified Type GB)
GC	X1/Y2; AC250V (Safety Standard Certified Type GC)
GD	Y3; AC250V (Safety Standard Certified Type GD)
GF	Y2, X1/Y2; AC250V (Safety Standard Certified Type GF)

⑦ Capacitance

Expressed by three-digit alphanumerics. The unit is pico-farad (pF). The first and second figures are significant digits, and the third figure expresses the number of zeros which follow the two numbers. If there is a decimal point, it is expressed by the capital letter "R". In this case, all figures are significant digits.

Ex.)

Code	Capacitance
R50	0.5pF
1R0	1.0pF
100	10pF
103	10000pF

Continued on the following page. 

Please check MURATA home page (<http://www.murata.com/index.html>) in case you can not find the part number on the catalog.

Continued from the preceding page.

⑨ Capacitance Tolerance

Code	Capacitance Tolerance	TC	Series	Capacitance Step	
W	±0.05pF	CΔ	GRM/GJM	≤9.9pF	0.1pF
B	±0.1pF	CΔ	GRM/GJM	≤9.9pF	0.1pF
			GQM	≤1pF	0.1pF
				1.1 to 9.9pF	1pF Step and E24 Series
			ERB	≤9.9pF	1pF Step and E24 Series
C	±0.25pF	CΔ	GRM/GJM	≤9.9pF	0.1pF
		except CΔ	GRM	≤5pF	* 1pF
		CΔ	ERB	≤9.9pF	1pF Step and E24 Series
			GQM	≤1pF	0.1pF
				1.1 to 9.9pF	1pF Step and E24 Series
D	±0.5pF	CΔ	GRM/GJM	5.1 to 9.9pF	0.1pF
		except CΔ	GRM	5.1 to 9.9pF	* 1pF
		CΔ	ERB/GQM	5.1 to 9.9pF	1pF Step and E24 Series
G	±2%	CΔ	GJM	≥10pF	E12 Series
		CΔ	GQM/ERB	≥10pF	E24 Series
J	±5%	CΔ-SL	GRM/GA3	≥10pF	E12 Series
		CΔ	ERB/GQM/GJM	≥10pF	E24 Series
K	±10%	B, R, X7R, X5R, ZLM	GRM/GR7/GA3		E6 Series
		C0G	GNM		E6 Series
		B, R, X7R, X5R, ZLM	GR4, GMD		E12 Series
M	±20%	B, R, X7R, X7S	GRM/GMA		E6 Series
		X5R, X7R, X7S	GNM		E3 Series
		X7R	GA2		E3 Series
		X5R, X7R, X7S, X6S	LLL/LLA/LLM		E3 Series
			GRM		E3 Series
Z	+80%, -20%	F, Y5V			
R			Depends on individual standards.		

* E24 series is also available.

⑩ Individual Specification Code

Expressed by three figures.

⑪ Packaging

Code	Packaging
L	ø180mm Embossed Taping
D	ø180mm Paper Taping
E	ø180mm Paper Taping (LLL15)
K	ø330mm Embossed Taping
J	ø330mm Paper Taping
F	ø330mm Paper Taping (LLL15)
B	Bulk
C	Bulk Case
T	Bulk Tray

Please check MURATA home page (<http://www.murata.com/index.html>) in case you can not find the part number on the catalog.

Selection Guide of Chip Monolithic Ceramic Capacitors

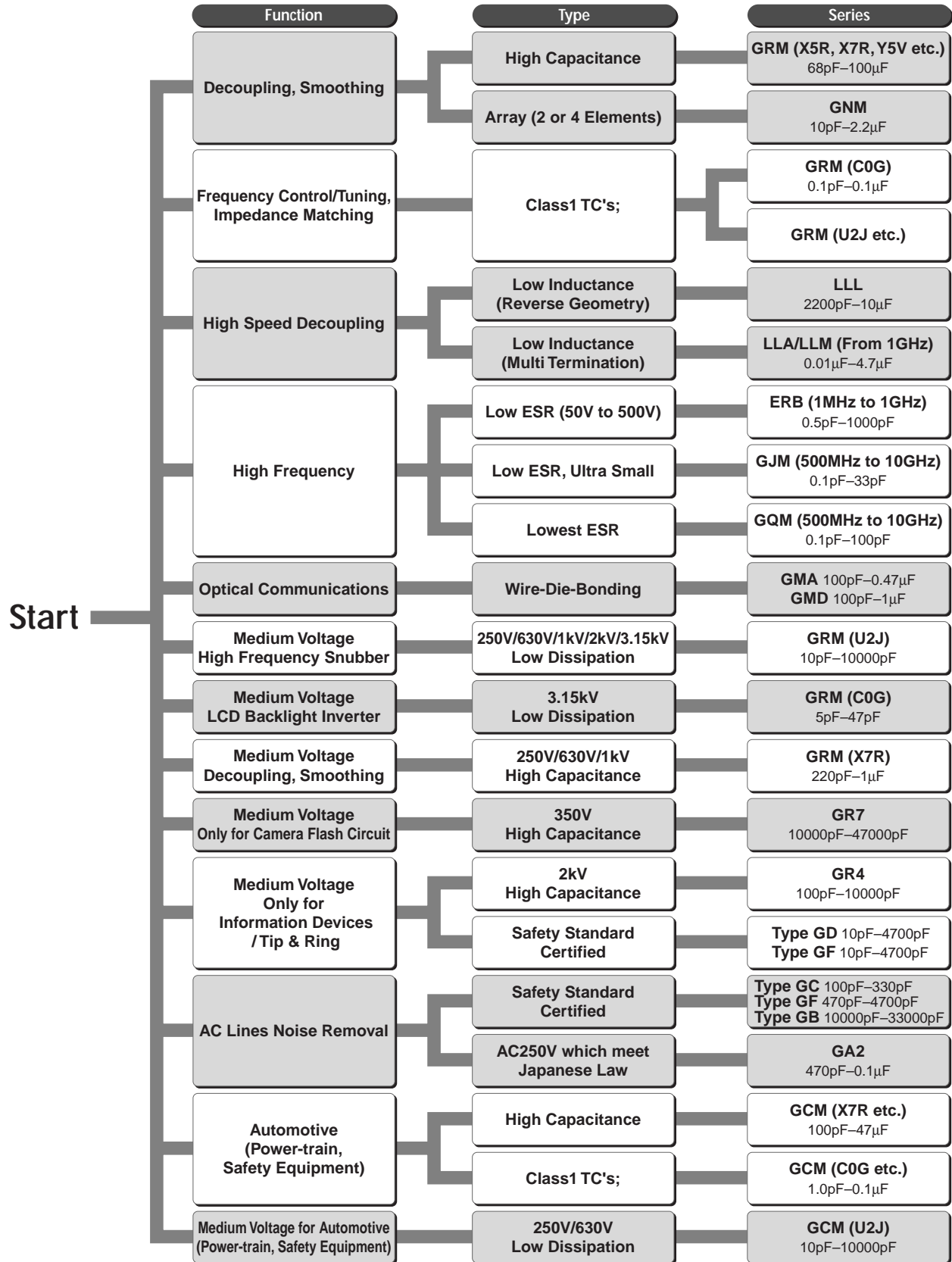

Chip Monolithic Ceramic Capacitors



for General Purpose GRM Series

■ Features

1. Higher resistance of solder-leaching due to the Ni-barriered termination, applicable for reflow-soldering, and flow-soldering (GRM18/21/31 type only).
2. The GRM series is lead free product.
3. Smaller size and higher capacitance value.
4. High reliability and no polarity.
5. Excellent pulse responsibility and noise reduction due to the low impedance at high frequency.
6. The GRM series is available in paper or embossed tape and reel packaging for automatic placement. Bulk case packaging is also available for GRM15/18/21(T=0.6,1.25).
7. Ta replacement.

■ Applications

General electronic equipment

Part Number	Dimensions (mm)				
	L	W	T	e	g min.
GRM022	0.4 ±0.02	0.2 ±0.02	0.2 ±0.02	0.07 to 0.14	0.13
GRM033	0.6 ±0.03	0.3 ±0.03	0.3 ±0.03	0.1 to 0.2	0.2
GRM15X			0.25 ±0.05		
GRM153	1.0 ±0.05	0.5 ±0.05	0.3 ±0.03	0.1 to 0.3	0.4
GRM155			0.5 ±0.05	0.15 to 0.35	0.3
GRM185			0.5 +0/-0.1		
GRM188*	1.6 ±0.1	0.8 ±0.1	0.8 ±0.1	0.2 to 0.5	0.5
GRM216			0.6 ±0.1		
GRM219	2.0 ±0.1	1.25 ±0.1	0.85 ±0.1	0.2 to 0.7	0.7
GRM21A			1.0 +0/-0.2		
GRM21B			1.25 ±0.1		
GRM316			0.6 ±0.1		
GRM319	3.2 ±0.15	1.6 ±0.15	0.85 ±0.1	0.3 to 0.8	1.5
GRM31M			1.15 ±0.1		
GRM31C	3.2 ±0.2	1.6 ±0.2	1.6 ±0.2		
GRM329			0.85 +0.15/-0.05		
GRM32A			1.0 +0/-0.2		
GRM32M			1.15 ±0.1		
GRM32N			1.35 ±0.15		
GRM32C	3.2 ±0.3	2.5 ±0.2	1.6 ±0.2	0.3 min.	1.0
GRM32R			1.8 ±0.2		
GRM32D			2.0 ±0.2		
GRM32E			2.5 ±0.2		

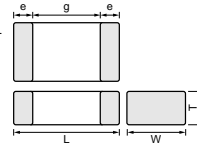

* Bulk Case: 1.6 ±0.07(L) × 0.8 ±0.07(W) × 0.8 ±0.07(T)
 * The figure indicates typical Specification.

Capacitance Table

1

Temperature Compensating Type C0G(5C),U2J(7U) Characteristics

6		ex.6: T Dimension [mm]																			
Capacitance	TC	LxW [mm]	C0G(5C)										U2J(7U)								
			0.4x0.2 (02) <01005>			1.0x0.5 (03) (15) <0201> <0402>		1.6x0.8 (18) <0603>		2.0x1.25 (21) <0805>		3.2x1.6 (31) <1206>		0.6x0.3 (03) <0201>		1.0x0.5 (15) <0402>		1.6x0.8 (18) <0603>	2.0x1.25 (21) <0805>		3.2x1.6 (31) <1206>
			16 (1C)	10 (1A)	6.3 (0J)	50 (1H)	50 (1H)	100 (1E)	50 (1H)	100 (1E)	50 (1H)	100 (1E)	50 (1H)	50 (1H)	25 (1E)	50 (1H)	10 (1A)	50 (1H)	10 (1A)	50 (1H)	10 (1A)
0.1pF(R10)				3	3, 5																
0.2pF(R20)	2			3	3, 5																
0.3pF(R30)	2			3	3, 5																
0.4pF(R40)	2			3	3, 5																
0.5pF(R50)	2			3	3, 5																
0.6pF(R60)	2			3	3, 5																
0.7pF(R70)	2			3	3, 5																
0.8pF(R80)	2			3	3, 5																
0.9pF(R90)	2			3	3, 5																
1.0pF(1R0)	2			3	3, 5								3		5						
1.1pF(1R1)	2			3	3, 5																
1.2pF(1R2)	2			3	3, 5																
1.3pF(1R3)	2			3	3, 5																
1.4pF(1R4)	2			3	3, 5																
1.5pF(1R5)	2			3	3, 5																
1.6pF(1R6)	2			3	3, 5																
1.7pF(1R7)	2			3	3, 5																
1.8pF(1R8)	2			3	3, 5																
1.9pF(1R9)	2			3	3, 5																
2.0pF(2R0)	2			3	3, 5								3		5						
2.1pF(2R1)	2			3	3, 5																
2.2pF(2R2)	2			3	3, 5																
2.3pF(2R3)	2			3	3, 5																
2.4pF(2R4)	2			3	3, 5																
2.5pF(2R5)	2			3	3, 5																
2.6pF(2R6)	2			3	3, 5																
2.7pF(2R7)	2			3	3, 5																
2.8pF(2R8)	2			3	3, 5																
2.9pF(2R9)	2			3	3, 5																
3.0pF(3R0)	2			3	3, 5								3		5						
3.1pF(3R1)	2			3	3, 5																
3.2pF(3R2)	2			3	3, 5																
3.3pF(3R3)	2			3	3, 5																
3.4pF(3R4)	2			3	3, 5																
3.5pF(3R5)	2			3	3, 5																
3.6pF(3R6)	2			3	3, 5																
3.7pF(3R7)	2			3	3, 5																
3.8pF(3R8)	2			3	3, 5																
3.9pF(3R9)	2			3	3, 5																
4.0pF(4R0)	2			3	3, 5								3		5						
4.1pF(4R1)	2			3	3, 5																
4.2pF(4R2)	2			3	3, 5																
4.3pF(4R3)	2			3	3, 5																
4.4pF(4R4)	2			3	3, 5																
4.5pF(4R5)	2			3	3, 5																
4.6pF(4R6)	2			3	3, 5																
4.7pF(4R7)	2			3	3, 5																
4.8pF(4R8)	2			3	3, 5																
4.9pF(4R9)	2			3	3, 5																

The part number code is shown in () and Unit is shown in []. < >: EIA [inch] Code

Continued on the following page. 

1

Capacitance Table

Continued from the preceding page.

6		ex.6: T Dimension [mm]																					
Capacitance	Rated Voltage [Vdc]	TC	LxW [mm]	C0G(5C)										U2J(7U)									
				0.4x0.2 (02) <01005>			0.6x0.3 (03) <0201>	1.0x0.5 (15) <0402>	1.6x0.8 (18) <0603>		2.0x1.25 (21) <0805>		3.2x1.6 (31) <1206>		0.6x0.3 (03) <0201>		1.0x0.5 (15) <0402>		1.6x0.8 (18) <0603>		2.0x1.25 (21) <0805>		3.2x1.6 (31) <1206>
				16 (1C)	10 (1A)	6.3 (0J)	50 (1H)	50 (1H)	100 (1E)	50 (1H)	100 (1E)	50 (1H)	100 (1E)	50 (1H)	50 (1H)	25 (1E)	50 (1H)	10 (1A)	50 (1H)	10 (1A)	50 (1H)	10 (1A)	50 (1H)
5.0pF(5R0)	2				3	3, 5							3		5								
5.1pF(5R1)	2				3	3, 5																	
5.2pF(5R2)	2				3	3, 5																	
5.3pF(5R3)	2				3	3, 5																	
5.4pF(5R4)	2				3	3, 5																	
5.5pF(5R5)	2				3	3, 5																	
5.6pF(5R6)	2				3	3, 5																	
5.7pF(5R7)	2				3	3, 5																	
5.8pF(5R8)	2				3	3, 5																	
5.9pF(5R9)	2				3	3, 5																	
6.0pF(6R0)	2				3	3, 5							3		5								
6.1pF(6R1)	2				3	3, 5																	
6.2pF(6R2)	2				3	3, 5																	
6.3pF(6R3)	2				3	3, 5																	
6.4pF(6R4)	2				3	3, 5																	
6.5pF(6R5)	2				3	3, 5																	
6.6pF(6R6)	2				3	3, 5																	
6.7pF(6R7)	2				3	3, 5																	
6.8pF(6R8)	2				3	3, 5																	
6.9pF(6R9)	2				3	3, 5																	
7.0pF(7R0)	2				3	3, 5							3		5								
7.1pF(7R1)	2				3	3, 5																	
7.2pF(7R2)	2				3	3, 5																	
7.3pF(7R3)	2				3	3, 5																	
7.4pF(7R4)	2				3	3, 5																	
7.5pF(7R5)	2				3	3, 5																	
7.6pF(7R6)	2				3	3, 5																	
7.7pF(7R7)	2				3	3, 5																	
7.8pF(7R8)	2				3	3, 5																	
7.9pF(7R9)	2				3	3, 5																	
8.0pF(8R0)	2				3	3, 5							3		5								
8.1pF(8R1)	2				3	3, 5																	
8.2pF(8R2)	2				3	3, 5																	
8.3pF(8R3)	2				3	3, 5																	
8.4pF(8R4)	2				3	3, 5																	
8.5pF(8R5)	2				3	3, 5																	
8.6pF(8R6)	2				3	3, 5																	
8.7pF(8R7)	2				3	3, 5																	
8.8pF(8R8)	2				3	3, 5																	
8.9pF(8R9)	2				3	3, 5																	
9.0pF(9R0)	2				3	3, 5							3		5								
9.1pF(9R1)	2				3	3, 5																	
9.2pF(9R2)	2				3	3, 5																	
9.3pF(9R3)	2				3	3, 5																	
9.4pF(9R4)	2				3	3, 5																	
9.5pF(9R5)	2				3	3, 5																	
9.6pF(9R6)	2				3	3, 5																	
9.7pF(9R7)	2				3	3, 5																	
9.8pF(9R8)	2				3	3, 5																	
9.9pF(9R9)	2				3	3, 5																	

The part number code is shown in () and Unit is shown in []. < >: EIA [inch] Code

Continued on the following page. ↗

Capacitance Table

Continued from the preceding page.

6 ex.6: T Dimension [mm]

Capacitance	Rated Voltage [Vdc]	TC LxW [mm]	C0G(5C)										U2J(7U)												
			0.4x0.2 (02) <01005>			0.6x0.3 (03) (15) <0201> <0402>		1.0x0.5 (18) (1H) <0603>		1.6x0.8 (18) (1H) <0603>		2.0x1.25 (21) (1H) <0805>		3.2x1.6 (31) (1H) <1206>		0.6x0.3 (03) <0201>		1.0x0.5 (15) <0402>		1.6x0.8 (18) <0603>		2.0x1.25 (21) <0805>		3.2x1.6 (31) <1206>	
			16 (1C)	10 (1A)	6.3 (0J)	50 (1H)	50 (1H)	100 (1E)	50 (1H)	100 (1E)	50 (1H)	100 (1E)	50 (1H)	50 (1H)	25 (1E)	50 (1H)	10 (1A)	50 (1H)	10 (1A)	50 (1H)	10 (1A)	50 (1H)	10 (1A)	50 (1H)	
10pF(100)	2			3	3,5	8	8							3		5									
12pF(120)	2			3	3,5	8	8							3		5									
15pF(150)	2			3	3,5	8	8							3		5									
18pF(180)	2			3	3,5	8	8								3	5									
22pF(220)	2			3	3,5	8	8								3	5									
27pF(270)	2			3	3,5	8	8								3	5									
33pF(330)	2			3	3,5	8	8								3	5									
39pF(390)	2			3	3,5	8	8								3	5									
47pF(470)	2			3	3,5	8	8								3	5									
56pF(560)		2	2	3	3,5	8	8								3	5									
68pF(680)		2	2	3	3,5	8	8								3	5									
82pF(820)		2	2	3	3,5	8	8								3	5									
100pF(101)		2	2	3	3,5	8	8	6							3	5									
120pF(121)					3,5	8	8	6								5									
150pF(151)					3,5	8	8	6								5									
180pF(181)					3,5	8	8	6								5									
220pF(221)					3,5	8	8	6																	
270pF(271)					3,5	8	8	6																	
330pF(331)					3,5	8	8	6																	
390pF(391)					3,5	8	8	6																	
470pF(471)					3,5	8	8	6																	
560pF(561)					3,5	8	8	6																	
680pF(681)					3,5	8	8	6																	
820pF(821)					5	8	8	6																	
1000pF(102)					5	8	8	6														8			
1200pF(122)						8	8	6	6								5	8							
1500pF(152)						8	8	6	6								5	8							
1800pF(182)							8	6	6	9							5	8							
2200pF(222)								8	6	6	9						5	5,8							
2700pF(272)									8	6	6	9					5	5,8							
3300pF(332)										8	6	6	9				5	5,8							
3900pF(392)										8		6	9				5	5,8							
4700pF(472)											6	9	9				5	5,8							
5600pF(562)												9	9	9				8	5						
6800pF(682)													9	9	9				8	5					
8200pF(822)														9	9	9				8	5				
10000pF(103)															9	9	9				8	5	6		
12000pF(123)																9					8	6			
15000pF(153)																	9					8	6		
18000pF(183)																		8					8		
22000pF(223)																			8				9		
27000pF(273)																							9		
33000pF(333)																							A		
39000pF(393)																							B		
47000pF(473)																							B		
56000pF(563)																							9		
68000pF(683)																							9		
82000pF(823)																							B		
0.1μF(104)																							B		

The part number code is shown in () and Unit is shown in []. < >: EIA [inch] Code

Continued on the following page. ↗

1

Capacitance Table

Continued from the preceding page.

Temperature Compensating Type P2H(6P),R2H(6R),S2H(6S),T2H(6T) Characteristics

6		ex.6: T Dimension [mm]								
Capacitance	TC	P2H (6P)		R2H (6R)		S2H (6S)		T2H (6T)		
		LxW [mm]	Rated Voltage [Vdc]	LxW [mm]	Rated Voltage [Vdc]	LxW [mm]	Rated Voltage [Vdc]	LxW [mm]	Rated Voltage [Vdc]	
1.0pF(1R0)		1.0x0.5 (15) <0402>	50 (1H)	0.6x0.3 (03) <0201>	25 (1E)	1.0x0.5 (15) <0402>	0.6x0.3 (03) <0201>	1.0x0.5 (15) <0402>	0.6x0.3 (03) <0201>	50 (1H)
2.0pF(2R0)										
3.0pF(3R0)										
4.0pF(4R0)										
5.0pF(5R0)										
6.0pF(6R0)										
7.0pF(7R0)										
8.0pF(8R0)										
9.0pF(9R0)										
10pF(100)										
12pF(120)										
15pF(150)										
18pF(180)										
22pF(220)										
27pF(270)										
33pF(330)										
39pF(390)										
47pF(470)										
56pF(560)										
68pF(680)										
82pF(820)										
100pF(101)										

The part number code is shown in () and Unit is shown in []. <->: EIA [inch] Code

Continued on the following page. ↗

Capacitance Table

Continued from the preceding page.

High Dielectric Constant Type X7R(R7)/X7S(C7)/X7T(D7)/X7U(E7) Characteristics

5 ex.5: T Dimension [mm]

Capacitance	Rated Voltage [Vdc]	0.4x0.2 (02) <01005>		0.6x0.3 (03) <0201>		1.0x0.5 (15) <0402>					1.6x0.8 (18) <0603>						2.0x1.25 (21) <0805>							
		(1A)	(1E)	(1C)	(1A)	(2A)	(1H)	(1E)	(1C)	(1A)	(2A)	(1H)	(1E)	(1C)	(1A)	(0J)	(0G)	(2A)	(1H)	(1E)	(1C)	(1A)	(0J)	(0G)
68pF(680)	2																							
100pF(101)	2	3																						
150pF(151)	2	3																						
220pF(221)	2	3				5	X, 5					8	8											
330pF(331)	2	3				5	X, 5					8	8											
470pF(471)	2	3				5	X, 5					8	8											
680pF(681)		3				5	X, 5					8	8											
1000pF(102)		3				5	X, 5					8	8											
1500pF(152)		3				5	X, 5					8	8											
2200pF(222)			3			5	5	X				8	8											
3300pF(332)			3			5	5		X			8	8											
4700pF(472)				3		5	5	5	X			8	8											
6800pF(682)					3	5	5	5	X			8	8							9				
10000pF(103)						3	5	5	X			8	8	8						B				
15000pF(153)							5	5	5			8	8							B				
22000pF(223)							5	5	5			8	8							B				
33000pF(333)								5	5			8	8							B	9			
47000pF(473)								5	5			8	8							B	B			
68000pF(683)								5	5			8	8							B	B	9		
0.10μF(104)								5	5	8	8	8	8							B	B	9		
0.15μF(154)												8	8							B	B			
0.22μF(224)												8	8							A	B	B		
0.33μF(334)													8	8						A	9	B		
0.47μF(474)												8	8	8						B	B	9		
0.68μF(684)													8								9	9		
1.0μF(105)												8	8	5, 8						B	9, B	B		
2.2μF(225)														8	8	8					B	B	B	
4.7μF(475)																					B	B	B	
10μF(106)																						B	B	
22μF(226)																							B	

Capacitance	Rated Voltage [Vdc]	3.2x1.6 (31) <1206>								3.2x2.5 (32) <1210>					
		(2A)	(1H)	(1E)	(1C)	(1A)	(0J)	(0G)	(2A)	(1H)	(YA)	(1E)	(1C)	(1A)	(0J)
15000pF(153)	9														
22000pF(223)	M														
33000pF(333)	M														
47000pF(473)	M														
68000pF(683)	M														
0.10μF(104)	9														
0.15μF(154)	M	M													
0.22μF(224)	M	M													
0.33μF(334)			9												
0.47μF(474)	M	M													
0.68μF(684)	M	M						C	N						
1.0μF(105)	C	M						C							
2.2μF(225)			C	M	M			E							
4.7μF(475)			C	C	C				E						
10μF(106)				C	C	C				E	D				
22μF(226)					C	C					E	E			
47μF(476)							C						E	E	

The part number code is shown in () and Unit is shown in []. < >: EIA [inch] Code

Continued on the following page. ↗

1

Capacitance Table

Continued from the preceding page.

High Dielectric Constant Type X6S(C8)/X6T(D8) Characteristics

5 ex.5: T Dimension [mm]

Capacitance	LxW [mm]	0.6x0.3 (03) <0201>		1.0x0.5 (15) <0402>		1.6x0.8 (18) <0603>			2.0x1.25 (21) <0805>				3.2x1.6 (31) <1206>				3.2x2.5 (32) <1210>						
		6.3 (0J)	25 (1E)	6.3 (0J)	4 (0G)	10 (1A)	6.3 (0J)	4 (0G)	2.5 (0E)	25 (1E)	16 (1C)	10 (1A)	6.3 (0J)	4 (0G)	25 (1E)	16 (1C)	10 (1A)	6.3 (0J)	4 (0G)	25 (1E)	10 (1A)	6.3 (0J)	
15000pF(153)		3																					
22000pF(223)		3																					
33000pF(333)		3																					
47000pF(473)		3																					
68000pF(683)			5																				
0.10μF(104)			5																				
0.15μF(154)				5	5																		
0.22μF(224)				5	5																		
0.33μF(334)				5	5																		
0.47μF(474)				5	5																		
0.68μF(684)					5																		
1.0μF(105)						5	5	8				6											
2.2μF(225)						8	8					9					6						
4.7μF(475)								8			B	B	9	9			9						
10μF(106)									8				B	9, B	9	C						D	
22μF(226)														B			C	C				E	
47μF(476)																	C	C				E	E
100μF(107)																		C					

The part number code is shown in () and Unit is shown in []. < >: EIA [inch] Code

Continued on the following page. ↗

Capacitance Table

Continued from the preceding page.

High Dielectric Constant Type X5R(R6) Characteristics

5 ex.5: T Dimension [mm] : Please refer to X7R(R7) etc Characteristics.

Capacitance	Rated Voltage [Vdc]	0.4x0.2 (02) <01005>		0.6x0.3 (03) <0201>				1.0x0.5 (15) <0402>						1.6x0.8 (18) <0603>								
		10 (1A)	6.3 (0J)	25 (1E)	16 (1C)	10 (1A)	6.3 (0J)	100 (2A)	50 (1H)	25 (1E)	16 (1C)	10 (1A)	6.3 (0J)	4 (0G)	100 (2A)	50 (1H)	25 (1E)	16 (1C)	10 (1A)	6.3 (0J)	4 (0G)	
68pF(680)	2																					
100pF(101)	2																					
150pF(151)	2																					
220pF(221)	2																					
330pF(331)	2																					
470pF(471)	2																					
680pF(681)	2																					
1000pF(102)	2									5												
1500pF(152)	2									5												
2200pF(222)	2									5												
3300pF(332)	2									5												
4700pF(472)	2									5												
6800pF(682)	2									5												
10000pF(103)	2									5												
15000pF(153)										5												
22000pF(223)										5												
33000pF(333)										5	5											
47000pF(473)										5	5											
68000pF(683)										5	5	5										
0.10μF(104)										5	5	5										
0.15μF(154)										5	5	5										
0.22μF(224)										5	5	5										
0.33μF(334)										5	5	5										
0.47μF(474)										5	5	5										
0.68μF(684)										5	5	5										
1.0μF(105)										5	5	5										
2.2μF(225)																						
4.7μF(475)																						
10μF(106)																						

Capacitance	Rated Voltage [Vdc]	2.0x1.25 (21) <0805>							3.2x1.6 (31) <1206>							3.2x2.5 (32) <1210>							
		100 (2A)	50 (1H)	25 (1E)	16 (1C)	10 (1A)	6.3 (0J)	4 (0G)	100 (2A)	50 (1H)	25 (1E)	16 (1C)	10 (1A)	6.3 (0J)	4 (0G)	100 (2A)	50 (1H)	35 (YA)	25 (1E)	16 (1C)	10 (1A)	6.3 (0J)	
6800pF(682)																							
10000pF(103)																							
15000pF(153)																							
22000pF(223)																							
33000pF(333)																							
47000pF(473)																							
68000pF(683)																							
0.10μF(104)																							
0.15μF(154)																							
0.22μF(224)																							
0.33μF(334)																							
0.47μF(474)																							
0.68μF(684)																							
1.0μF(105)																							
2.2μF(225)																							
4.7μF(475)																							
10μF(106)																							
22μF(226)																							
47μF(476)																							
100μF(107)																							

The part number code is shown in () and Unit is shown in []. < >: EIA [inch] Code

1

Temperature Compensating Type C0G(5C) Characteristics

LxW [mm]		0.4x0.2(02)<01005>	0.6x0.3(03)<0201>	1.0x0.5(15)<0402>
Rated Volt. [Vdc]		16(1C)	50(1H)	50(1H)
Capacitance	Tolerance	Part Number		
0.1pF(R10)	±0.05pF(W)		GRM0335C1HR10WD01D	GRM1555C1HR10WA01D
	±0.1pF(B)		GRM0335C1HR10BD01D	GRM1555C1HR10BA01D
0.2pF(R20)	±0.05pF(W)	GRM0225C1CR20WD05L	GRM0335C1HR20WD01D	GRM1555C1HR20WA01D
	±0.1pF(B)	GRM0225C1CR20BD05L	GRM0335C1HR20BD01D	GRM1555C1HR20BA01D
0.3pF(R30)	±0.05pF(W)	GRM0225C1CR30WD05L	GRM0335C1HR30WD01D	GRM1555C1HR30WA01D
	±0.1pF(B)	GRM0225C1CR30BD05L	GRM0335C1HR30BD01D	GRM1555C1HR30BA01D
0.4pF(R40)	±0.05pF(W)	GRM0225C1CR40WD05L	GRM0335C1HR40WD01D	GRM1555C1HR40WA01D
	±0.1pF(B)	GRM0225C1CR40BD05L	GRM0335C1HR40BD01D	GRM1555C1HR40BA01D
0.5pF(R50)	±0.05pF(W)	GRM0225C1CR50WD05L	GRM0335C1HR50WD01D	GRM1555C1HR50WA01D
	±0.1pF(B)	GRM0225C1CR50BD05L	GRM0335C1HR50BD01D	GRM1555C1HR50BA01D
0.6pF(R60)	±0.05pF(W)	GRM0225C1CR60WD05L	GRM0335C1HR60WD01D	GRM1555C1HR60WA01D
	±0.1pF(B)	GRM0225C1CR60BD05L	GRM0335C1HR60BD01D	GRM1555C1HR60BA01D
0.7pF(R70)	±0.05pF(W)	GRM0225C1CR70WD05L	GRM0335C1HR70WD01D	GRM1555C1HR70WA01D
	±0.1pF(B)	GRM0225C1CR70BD05L	GRM0335C1HR70BD01D	GRM1555C1HR70BA01D
0.8pF(R80)	±0.05pF(W)	GRM0225C1CR80WD05L	GRM0335C1HR80WD01D	GRM1555C1HR80WA01D
	±0.1pF(B)	GRM0225C1CR80BD05L	GRM0335C1HR80BD01D	GRM1555C1HR80BA01D
0.9pF(R90)	±0.05pF(W)	GRM0225C1CR90WD05L	GRM0335C1HR90WD01D	GRM1555C1HR90WA01D
	±0.1pF(B)	GRM0225C1CR90BD05L	GRM0335C1HR90BD01D	GRM1555C1HR90BA01D
1.0pF(1R0)	±0.05pF(W)	GRM0225C1C1R0WD05L	GRM0335C1H1R0WD01D	GRM1555C1H1R0WA01D
	±0.1pF(B)	GRM0225C1C1R0BD05L	GRM0335C1H1R0BD01D	GRM1555C1H1R0BA01D
	±0.25pF(C)	GRM0225C1C1R0CD05L	GRM0335C1H1R0CD01D	GRM1555C1H1R0CA01D
1.1pF(1R1)	±0.05pF(W)	GRM0225C1C1R1WD05L	GRM0335C1H1R1WD01D	GRM1555C1H1R1WA01D
	±0.1pF(B)	GRM0225C1C1R1BD05L	GRM0335C1H1R1BD01D	GRM1555C1H1R1BA01D
	±0.25pF(C)	GRM0225C1C1R1CD05L	GRM0335C1H1R1CD01D	GRM1555C1H1R1CA01D
1.2pF(1R2)	±0.05pF(W)	GRM0225C1C1R2WD05L	GRM0335C1H1R2WD01D	GRM1555C1H1R2WA01D
	±0.1pF(B)	GRM0225C1C1R2BD05L	GRM0335C1H1R2BD01D	GRM1555C1H1R2BA01D
	±0.25pF(C)	GRM0225C1C1R2CD05L	GRM0335C1H1R2CD01D	GRM1555C1H1R2CA01D
1.3pF(1R3)	±0.05pF(W)	GRM0225C1C1R3WD05L	GRM0335C1H1R3WD01D	GRM1555C1H1R3WA01D
	±0.1pF(B)	GRM0225C1C1R3BD05L	GRM0335C1H1R3BD01D	GRM1555C1H1R3BA01D
	±0.25pF(C)	GRM0225C1C1R3CD05L	GRM0335C1H1R3CD01D	GRM1555C1H1R3CA01D
1.4pF(1R4)	±0.05pF(W)	GRM0225C1C1R4WD05L	GRM0335C1H1R4WD01D	GRM1555C1H1R4WA01D
	±0.1pF(B)	GRM0225C1C1R4BD05L	GRM0335C1H1R4BD01D	GRM1555C1H1R4BA01D
	±0.25pF(C)	GRM0225C1C1R4CD05L	GRM0335C1H1R4CD01D	GRM1555C1H1R4CA01D
1.5pF(1R5)	±0.05pF(W)	GRM0225C1C1R5WD05L	GRM0335C1H1R5WD01D	GRM1555C1H1R5WA01D
	±0.1pF(B)	GRM0225C1C1R5BD05L	GRM0335C1H1R5BD01D	GRM1555C1H1R5BA01D
	±0.25pF(C)	GRM0225C1C1R5CD05L	GRM0335C1H1R5CD01D	GRM1555C1H1R5CA01D
1.6pF(1R6)	±0.05pF(W)	GRM0225C1C1R6WD05L	GRM0335C1H1R6WD01D	GRM1555C1H1R6WA01D
	±0.1pF(B)	GRM0225C1C1R6BD05L	GRM0335C1H1R6BD01D	GRM1555C1H1R6BA01D
	±0.25pF(C)	GRM0225C1C1R6CD05L	GRM0335C1H1R6CD01D	GRM1555C1H1R6CA01D
1.7pF(1R7)	±0.05pF(W)	GRM0225C1C1R7WD05L	GRM0335C1H1R7WD01D	GRM1555C1H1R7WA01D
	±0.1pF(B)	GRM0225C1C1R7BD05L	GRM0335C1H1R7BD01D	GRM1555C1H1R7BA01D
	±0.25pF(C)	GRM0225C1C1R7CD05L	GRM0335C1H1R7CD01D	GRM1555C1H1R7CA01D
1.8pF(1R8)	±0.05pF(W)	GRM0225C1C1R8WD05L	GRM0335C1H1R8WD01D	GRM1555C1H1R8WA01D
	±0.1pF(B)	GRM0225C1C1R8BD05L	GRM0335C1H1R8BD01D	GRM1555C1H1R8BA01D
	±0.25pF(C)	GRM0225C1C1R8CD05L	GRM0335C1H1R8CD01D	GRM1555C1H1R8CA01D
1.9pF(1R9)	±0.05pF(W)	GRM0225C1C1R9WD05L	GRM0335C1H1R9WD01D	GRM1555C1H1R9WA01D
	±0.1pF(B)	GRM0225C1C1R9BD05L	GRM0335C1H1R9BD01D	GRM1555C1H1R9BA01D
	±0.25pF(C)	GRM0225C1C1R9CD05L	GRM0335C1H1R9CD01D	GRM1555C1H1R9CA01D
2.0pF(2R0)	±0.05pF(W)	GRM0225C1C2R0WD05L	GRM0335C1H2R0WD01D	GRM1555C1H2R0WA01D
	±0.1pF(B)	GRM0225C1C2R0BD05L	GRM0335C1H2R0BD01D	GRM1555C1H2R0BA01D
	±0.25pF(C)	GRM0225C1C2R0CD05L	GRM0335C1H2R0CD01D	GRM1555C1H2R0CA01D

The part number code is shown in () and Unit is shown in []. < >: EIA [inch] Code

(Part Number) **GR** **M** **02** **2** **5C** **1C** **R20** **W** **D05** **L** ①Product ID ②Series ③Dimension (LxW) ④Dimension (T)
 ⑤Temperature Characteristics ⑥Rated Voltage ⑦Capacitance
 ⑧Capacitance Tolerance ⑨Individual Specification Code ⑩Packaging*

Packaging Code in Part Number is a code shows STD 180mm Reel Taping.

*GRM022: D is applicable.

Temperature Compensating Type C0G(5C) Characteristics

LxW [mm]		0.4x0.2(02)<01005>	0.6x0.3(03)<0201>	1.0x0.5(15)<0402>
Rated Volt. [Vdc]		16(1C)	50(1H)	50(1H)
Capacitance	Tolerance	Part Number		
2.1pF(2R1)	±0.05pF(W)	GRM0225C1C2R1WD05L	GRM0335C1H2R1WD01D	GRM1555C1H2R1WA01D
	±0.1pF(B)	GRM0225C1C2R1BD05L	GRM0335C1H2R1BD01D	GRM1555C1H2R1BA01D
	±0.25pF(C)	GRM0225C1C2R1CD05L	GRM0335C1H2R1CD01D	GRM1555C1H2R1CA01D
2.2pF(2R2)	±0.05pF(W)	GRM0225C1C2R2WD05L	GRM0335C1H2R2WD01D	GRM1555C1H2R2WA01D
	±0.1pF(B)	GRM0225C1C2R2BD05L	GRM0335C1H2R2BD01D	GRM1555C1H2R2BA01D
	±0.25pF(C)	GRM0225C1C2R2CD05L	GRM0335C1H2R2CD01D	GRM1555C1H2R2CA01D
2.3pF(2R3)	±0.05pF(W)	GRM0225C1C2R3WD05L	GRM0335C1H2R3WD01D	GRM1555C1H2R3WA01D
	±0.1pF(B)	GRM0225C1C2R3BD05L	GRM0335C1H2R3BD01D	GRM1555C1H2R3BA01D
	±0.25pF(C)	GRM0225C1C2R3CD05L	GRM0335C1H2R3CD01D	GRM1555C1H2R3CA01D
2.4pF(2R4)	±0.05pF(W)	GRM0225C1C2R4WD05L	GRM0335C1H2R4WD01D	GRM1555C1H2R4WA01D
	±0.1pF(B)	GRM0225C1C2R4BD05L	GRM0335C1H2R4BD01D	GRM1555C1H2R4BA01D
	±0.25pF(C)	GRM0225C1C2R4CD05L	GRM0335C1H2R4CD01D	GRM1555C1H2R4CA01D
2.5pF(2R5)	±0.05pF(W)	GRM0225C1C2R5WD05L	GRM0335C1H2R5WD01D	GRM1555C1H2R5WA01D
	±0.1pF(B)	GRM0225C1C2R5BD05L	GRM0335C1H2R5BD01D	GRM1555C1H2R5BA01D
	±0.25pF(C)	GRM0225C1C2R5CD05L	GRM0335C1H2R5CD01D	GRM1555C1H2R5CA01D
2.6pF(2R6)	±0.05pF(W)	GRM0225C1C2R6WD05L	GRM0335C1H2R6WD01D	GRM1555C1H2R6WA01D
	±0.1pF(B)	GRM0225C1C2R6BD05L	GRM0335C1H2R6BD01D	GRM1555C1H2R6BA01D
	±0.25pF(C)	GRM0225C1C2R6CD05L	GRM0335C1H2R6CD01D	GRM1555C1H2R6CA01D
2.7pF(2R7)	±0.05pF(W)	GRM0225C1C2R7WD05L	GRM0335C1H2R7WD01D	GRM1555C1H2R7WA01D
	±0.1pF(B)	GRM0225C1C2R7BD05L	GRM0335C1H2R7BD01D	GRM1555C1H2R7BA01D
	±0.25pF(C)	GRM0225C1C2R7CD05L	GRM0335C1H2R7CD01D	GRM1555C1H2R7CA01D
2.8pF(2R8)	±0.05pF(W)	GRM0225C1C2R8WD05L	GRM0335C1H2R8WD01D	GRM1555C1H2R8WA01D
	±0.1pF(B)	GRM0225C1C2R8BD05L	GRM0335C1H2R8BD01D	GRM1555C1H2R8BA01D
	±0.25pF(C)	GRM0225C1C2R8CD05L	GRM0335C1H2R8CD01D	GRM1555C1H2R8CA01D
2.9pF(2R9)	±0.05pF(W)	GRM0225C1C2R9WD05L	GRM0335C1H2R9WD01D	GRM1555C1H2R9WA01D
	±0.1pF(B)	GRM0225C1C2R9BD05L	GRM0335C1H2R9BD01D	GRM1555C1H2R9BA01D
	±0.25pF(C)	GRM0225C1C2R9CD05L	GRM0335C1H2R9CD01D	GRM1555C1H2R9CA01D
3.0pF(3R0)	±0.05pF(W)	GRM0225C1C3R0WD05L	GRM0335C1H3R0WD01D	GRM1555C1H3R0WA01D
	±0.1pF(B)	GRM0225C1C3R0BD05L	GRM0335C1H3R0BD01D	GRM1555C1H3R0BA01D
	±0.25pF(C)	GRM0225C1C3R0CD05L	GRM0335C1H3R0CD01D	GRM1555C1H3R0CA01D
3.1pF(3R1)	±0.05pF(W)	GRM0225C1C3R1WD05L	GRM0335C1H3R1WD01D	GRM1555C1H3R1WA01D
	±0.1pF(B)	GRM0225C1C3R1BD05L	GRM0335C1H3R1BD01D	GRM1555C1H3R1BA01D
	±0.25pF(C)	GRM0225C1C3R1CD05L	GRM0335C1H3R1CD01D	GRM1555C1H3R1CA01D
3.2pF(3R2)	±0.05pF(W)	GRM0225C1C3R2WD05L	GRM0335C1H3R2WD01D	GRM1555C1H3R2WA01D
	±0.1pF(B)	GRM0225C1C3R2BD05L	GRM0335C1H3R2BD01D	GRM1555C1H3R2BA01D
	±0.25pF(C)	GRM0225C1C3R2CD05L	GRM0335C1H3R2CD01D	GRM1555C1H3R2CA01D
3.3pF(3R3)	±0.05pF(W)	GRM0225C1C3R3WD05L	GRM0335C1H3R3WD01D	GRM1555C1H3R3WA01D
	±0.1pF(B)	GRM0225C1C3R3BD05L	GRM0335C1H3R3BD01D	GRM1555C1H3R3BA01D
	±0.25pF(C)	GRM0225C1C3R3CD05L	GRM0335C1H3R3CD01D	GRM1555C1H3R3CA01D
3.4pF(3R4)	±0.05pF(W)	GRM0225C1C3R4WD05L	GRM0335C1H3R4WD01D	GRM1555C1H3R4WA01D
	±0.1pF(B)	GRM0225C1C3R4BD05L	GRM0335C1H3R4BD01D	GRM1555C1H3R4BA01D
	±0.25pF(C)	GRM0225C1C3R4CD05L	GRM0335C1H3R4CD01D	GRM1555C1H3R4CA01D
3.5pF(3R5)	±0.05pF(W)	GRM0225C1C3R5WD05L	GRM0335C1H3R5WD01D	GRM1555C1H3R5WA01D
	±0.1pF(B)	GRM0225C1C3R5BD05L	GRM0335C1H3R5BD01D	GRM1555C1H3R5BA01D
	±0.25pF(C)	GRM0225C1C3R5CD05L	GRM0335C1H3R5CD01D	GRM1555C1H3R5CA01D
3.6pF(3R6)	±0.05pF(W)	GRM0225C1C3R6WD05L	GRM0335C1H3R6WD01D	GRM1555C1H3R6WA01D
	±0.1pF(B)	GRM0225C1C3R6BD05L	GRM0335C1H3R6BD01D	GRM1555C1H3R6BA01D
	±0.25pF(C)	GRM0225C1C3R6CD05L	GRM0335C1H3R6CD01D	GRM1555C1H3R6CA01D
3.7pF(3R7)	±0.05pF(W)	GRM0225C1C3R7WD05L	GRM0335C1H3R7WD01D	GRM1555C1H3R7WA01D
	±0.1pF(B)	GRM0225C1C3R7BD05L	GRM0335C1H3R7BD01D	GRM1555C1H3R7BA01D
	±0.25pF(C)	GRM0225C1C3R7CD05L	GRM0335C1H3R7CD01D	GRM1555C1H3R7CA01D

The part number code is shown in () and Unit is shown in []. <->: EIA [inch] Code

1

Temperature Compensating Type C0G(5C) Characteristics

LxW [mm]		0.4x0.2(02)<01005>	0.6x0.3(03)<0201>	1.0x0.5(15)<0402>
Rated Volt. [Vdc]		16(1C)	50(1H)	50(1H)
Capacitance	Tolerance	Part Number		
3.8pF(3R8)	±0.05pF(W)	GRM0225C1C3R8WD05L	GRM0335C1H3R8WD01D	GRM1555C1H3R8WA01D
	±0.1pF(B)	GRM0225C1C3R8BD05L	GRM0335C1H3R8BD01D	GRM1555C1H3R8BA01D
	±0.25pF(C)	GRM0225C1C3R8CD05L	GRM0335C1H3R8CD01D	GRM1555C1H3R8CA01D
3.9pF(3R9)	±0.05pF(W)	GRM0225C1C3R9WD05L	GRM0335C1H3R9WD01D	GRM1555C1H3R9WA01D
	±0.1pF(B)	GRM0225C1C3R9BD05L	GRM0335C1H3R9BD01D	GRM1555C1H3R9BA01D
	±0.25pF(C)	GRM0225C1C3R9CD05L	GRM0335C1H3R9CD01D	GRM1555C1H3R9CA01D
4.0pF(4R0)	±0.05pF(W)	GRM0225C1C4R0WD05L	GRM0335C1H4R0WD01D	GRM1555C1H4R0WA01D
	±0.1pF(B)	GRM0225C1C4R0BD05L	GRM0335C1H4R0BD01D	GRM1555C1H4R0BA01D
	±0.25pF(C)	GRM0225C1C4R0CD05L	GRM0335C1H4R0CD01D	GRM1555C1H4R0CA01D
4.1pF(4R1)	±0.05pF(W)	GRM0225C1C4R1WD05L	GRM0335C1H4R1WD01D	GRM1555C1H4R1WA01D
	±0.1pF(B)	GRM0225C1C4R1BD05L	GRM0335C1H4R1BD01D	GRM1555C1H4R1BA01D
	±0.25pF(C)	GRM0225C1C4R1CD05L	GRM0335C1H4R1CD01D	GRM1555C1H4R1CA01D
4.2pF(4R2)	±0.05pF(W)	GRM0225C1C4R2WD05L	GRM0335C1H4R2WD01D	GRM1555C1H4R2WA01D
	±0.1pF(B)	GRM0225C1C4R2BD05L	GRM0335C1H4R2BD01D	GRM1555C1H4R2BA01D
	±0.25pF(C)	GRM0225C1C4R2CD05L	GRM0335C1H4R2CD01D	GRM1555C1H4R2CA01D
4.3pF(4R3)	±0.05pF(W)	GRM0225C1C4R3WD05L	GRM0335C1H4R3WD01D	GRM1555C1H4R3WA01D
	±0.1pF(B)	GRM0225C1C4R3BD05L	GRM0335C1H4R3BD01D	GRM1555C1H4R3BA01D
	±0.25pF(C)	GRM0225C1C4R3CD05L	GRM0335C1H4R3CD01D	GRM1555C1H4R3CA01D
4.4pF(4R4)	±0.05pF(W)	GRM0225C1C4R4WD05L	GRM0335C1H4R4WD01D	GRM1555C1H4R4WA01D
	±0.1pF(B)	GRM0225C1C4R4BD05L	GRM0335C1H4R4BD01D	GRM1555C1H4R4BA01D
	±0.25pF(C)	GRM0225C1C4R4CD05L	GRM0335C1H4R4CD01D	GRM1555C1H4R4CA01D
4.5pF(4R5)	±0.05pF(W)	GRM0225C1C4R5WD05L	GRM0335C1H4R5WD01D	GRM1555C1H4R5WA01D
	±0.1pF(B)	GRM0225C1C4R5BD05L	GRM0335C1H4R5BD01D	GRM1555C1H4R5BA01D
	±0.25pF(C)	GRM0225C1C4R5CD05L	GRM0335C1H4R5CD01D	GRM1555C1H4R5CA01D
4.6pF(4R6)	±0.05pF(W)	GRM0225C1C4R6WD05L	GRM0335C1H4R6WD01D	GRM1555C1H4R6WA01D
	±0.1pF(B)	GRM0225C1C4R6BD05L	GRM0335C1H4R6BD01D	GRM1555C1H4R6BA01D
	±0.25pF(C)	GRM0225C1C4R6CD05L	GRM0335C1H4R6CD01D	GRM1555C1H4R6CA01D
4.7pF(4R7)	±0.05pF(W)	GRM0225C1C4R7WD05L	GRM0335C1H4R7WD01D	GRM1555C1H4R7WA01D
	±0.1pF(B)	GRM0225C1C4R7BD05L	GRM0335C1H4R7BD01D	GRM1555C1H4R7BA01D
	±0.25pF(C)	GRM0225C1C4R7CD05L	GRM0335C1H4R7CD01D	GRM1555C1H4R7CA01D
4.8pF(4R8)	±0.05pF(W)	GRM0225C1C4R8WD05L	GRM0335C1H4R8WD01D	GRM1555C1H4R8WA01D
	±0.1pF(B)	GRM0225C1C4R8BD05L	GRM0335C1H4R8BD01D	GRM1555C1H4R8BA01D
	±0.25pF(C)	GRM0225C1C4R8CD05L	GRM0335C1H4R8CD01D	GRM1555C1H4R8CA01D
4.9pF(4R9)	±0.05pF(W)	GRM0225C1C4R9WD05L	GRM0335C1H4R9WD01D	GRM1555C1H4R9WA01D
	±0.1pF(B)	GRM0225C1C4R9BD05L	GRM0335C1H4R9BD01D	GRM1555C1H4R9BA01D
	±0.25pF(C)	GRM0225C1C4R9CD05L	GRM0335C1H4R9CD01D	GRM1555C1H4R9CA01D
5.0pF(5R0)	±0.05pF(W)	GRM0225C1C5R0WD05L	GRM0335C1H5R0WD01D	GRM1555C1H5R0WA01D
	±0.1pF(B)	GRM0225C1C5R0BD05L	GRM0335C1H5R0BD01D	GRM1555C1H5R0BA01D
	±0.25pF(C)	GRM0225C1C5R0CD05L	GRM0335C1H5R0CD01D	GRM1555C1H5R0CA01D
5.1pF(5R1)	±0.05pF(W)	GRM0225C1C5R1WD05L	GRM0335C1H5R1WD01D	GRM1555C1H5R1WA01D
	±0.1pF(B)	GRM0225C1C5R1BD05L	GRM0335C1H5R1BD01D	GRM1555C1H5R1BA01D
	±0.25pF(C)	GRM0225C1C5R1CD05L	GRM0335C1H5R1CD01D	GRM1555C1H5R1CA01D
	±0.5pF(D)	GRM0225C1C5R1DD05L	GRM0335C1H5R1DD01D	GRM1555C1H5R1DA01D
5.2pF(5R2)	±0.05pF(W)	GRM0225C1C5R2WD05L	GRM0335C1H5R2WD01D	GRM1555C1H5R2WA01D
	±0.1pF(B)	GRM0225C1C5R2BD05L	GRM0335C1H5R2BD01D	GRM1555C1H5R2BA01D
	±0.25pF(C)	GRM0225C1C5R2CD05L	GRM0335C1H5R2CD01D	GRM1555C1H5R2CA01D
	±0.5pF(D)	GRM0225C1C5R2DD05L	GRM0335C1H5R2DD01D	GRM1555C1H5R2DA01D

The part number code is shown in () and Unit is shown in []. < >: EIA [inch] Code

(Part Number) **GR M 02 2 5C 1C 3R8 W D05 L**

①Product ID ②Series
⑤Temperature Characteristics
⑥Capacitance Tolerance

③Dimension (LxW)
④Rated Voltage
⑨Individual Specification Code

④Dimension (T)
⑦Capacitance
⑩Packaging*

Packaging Code in Part Number is a code shows STD 180mm Reel Taping.

*GRM022: D is applicable.

Temperature Compensating Type C0G(5C) Characteristics

LxW [mm]		0.4x0.2(02)<01005>	0.6x0.3(03)<0201>	1.0x0.5(15)<0402>
Rated Volt. [Vdc]		16(1C)	50(1H)	50(1H)
Capacitance	Tolerance	Part Number		
5.3pF(5R3)	±0.05pF(W)	GRM0225C1C5R3WD05L	GRM0335C1H5R3WD01D	GRM1555C1H5R3WA01D
	±0.1pF(B)	GRM0225C1C5R3BD05L	GRM0335C1H5R3BD01D	GRM1555C1H5R3BA01D
	±0.25pF(C)	GRM0225C1C5R3CD05L	GRM0335C1H5R3CD01D	GRM1555C1H5R3CA01D
	±0.5pF(D)	GRM0225C1C5R3DD05L	GRM0335C1H5R3DD01D	GRM1555C1H5R3DA01D
5.4pF(5R4)	±0.05pF(W)	GRM0225C1C5R4WD05L	GRM0335C1H5R4WD01D	GRM1555C1H5R4WA01D
	±0.1pF(B)	GRM0225C1C5R4BD05L	GRM0335C1H5R4BD01D	GRM1555C1H5R4BA01D
	±0.25pF(C)	GRM0225C1C5R4CD05L	GRM0335C1H5R4CD01D	GRM1555C1H5R4CA01D
	±0.5pF(D)	GRM0225C1C5R4DD05L	GRM0335C1H5R4DD01D	GRM1555C1H5R4DA01D
5.5pF(5R5)	±0.05pF(W)	GRM0225C1C5R5WD05L	GRM0335C1H5R5WD01D	GRM1555C1H5R5WA01D
	±0.1pF(B)	GRM0225C1C5R5BD05L	GRM0335C1H5R5BD01D	GRM1555C1H5R5BA01D
	±0.25pF(C)	GRM0225C1C5R5CD05L	GRM0335C1H5R5CD01D	GRM1555C1H5R5CA01D
	±0.5pF(D)	GRM0225C1C5R5DD05L	GRM0335C1H5R5DD01D	GRM1555C1H5R5DA01D
5.6pF(5R6)	±0.05pF(W)	GRM0225C1C5R6WD05L	GRM0335C1H5R6WD01D	GRM1555C1H5R6WA01D
	±0.1pF(B)	GRM0225C1C5R6BD05L	GRM0335C1H5R6BD01D	GRM1555C1H5R6BA01D
	±0.25pF(C)	GRM0225C1C5R6CD05L	GRM0335C1H5R6CD01D	GRM1555C1H5R6CA01D
	±0.5pF(D)	GRM0225C1C5R6DD05L	GRM0335C1H5R6DD01D	GRM1555C1H5R6DA01D
5.7pF(5R7)	±0.05pF(W)	GRM0225C1C5R7WD05L	GRM0335C1H5R7WD01D	GRM1555C1H5R7WA01D
	±0.1pF(B)	GRM0225C1C5R7BD05L	GRM0335C1H5R7BD01D	GRM1555C1H5R7BA01D
	±0.25pF(C)	GRM0225C1C5R7CD05L	GRM0335C1H5R7CD01D	GRM1555C1H5R7CA01D
	±0.5pF(D)	GRM0225C1C5R7DD05L	GRM0335C1H5R7DD01D	GRM1555C1H5R7DA01D
5.8pF(5R8)	±0.05pF(W)	GRM0225C1C5R8WD05L	GRM0335C1H5R8WD01D	GRM1555C1H5R8WA01D
	±0.1pF(B)	GRM0225C1C5R8BD05L	GRM0335C1H5R8BD01D	GRM1555C1H5R8BA01D
	±0.25pF(C)	GRM0225C1C5R8CD05L	GRM0335C1H5R8CD01D	GRM1555C1H5R8CA01D
	±0.5pF(D)	GRM0225C1C5R8DD05L	GRM0335C1H5R8DD01D	GRM1555C1H5R8DA01D
5.9pF(5R9)	±0.05pF(W)	GRM0225C1C5R9WD05L	GRM0335C1H5R9WD01D	GRM1555C1H5R9WA01D
	±0.1pF(B)	GRM0225C1C5R9BD05L	GRM0335C1H5R9BD01D	GRM1555C1H5R9BA01D
	±0.25pF(C)	GRM0225C1C5R9CD05L	GRM0335C1H5R9CD01D	GRM1555C1H5R9CA01D
	±0.5pF(D)	GRM0225C1C5R9DD05L	GRM0335C1H5R9DD01D	GRM1555C1H5R9DA01D
6.0pF(6R0)	±0.05pF(W)	GRM0225C1C6R0WD05L	GRM0335C1H6R0WD01D	GRM1555C1H6R0WA01D
	±0.1pF(B)	GRM0225C1C6R0BD05L	GRM0335C1H6R0BD01D	GRM1555C1H6R0BA01D
	±0.25pF(C)	GRM0225C1C6R0CD05L	GRM0335C1H6R0CD01D	GRM1555C1H6R0CA01D
	±0.5pF(D)	GRM0225C1C6R0DD05L	GRM0335C1H6R0DD01D	GRM1555C1H6R0DA01D
6.1pF(6R1)	±0.05pF(W)	GRM0225C1C6R1WD05L	GRM0335C1H6R1WD01D	GRM1555C1H6R1WA01D
	±0.1pF(B)	GRM0225C1C6R1BD05L	GRM0335C1H6R1BD01D	GRM1555C1H6R1BA01D
	±0.25pF(C)	GRM0225C1C6R1CD05L	GRM0335C1H6R1CD01D	GRM1555C1H6R1CA01D
	±0.5pF(D)	GRM0225C1C6R1DD05L	GRM0335C1H6R1DD01D	GRM1555C1H6R1DA01D
6.2pF(6R2)	±0.05pF(W)	GRM0225C1C6R2WD05L	GRM0335C1H6R2WD01D	GRM1555C1H6R2WA01D
	±0.1pF(B)	GRM0225C1C6R2BD05L	GRM0335C1H6R2BD01D	GRM1555C1H6R2BA01D
	±0.25pF(C)	GRM0225C1C6R2CD05L	GRM0335C1H6R2CD01D	GRM1555C1H6R2CA01D
	±0.5pF(D)	GRM0225C1C6R2DD05L	GRM0335C1H6R2DD01D	GRM1555C1H6R2DA01D
6.3pF(6R3)	±0.05pF(W)	GRM0225C1C6R3WD05L	GRM0335C1H6R3WD01D	GRM1555C1H6R3WA01D
	±0.1pF(B)	GRM0225C1C6R3BD05L	GRM0335C1H6R3BD01D	GRM1555C1H6R3BA01D
	±0.25pF(C)	GRM0225C1C6R3CD05L	GRM0335C1H6R3CD01D	GRM1555C1H6R3CA01D
	±0.5pF(D)	GRM0225C1C6R3DD05L	GRM0335C1H6R3DD01D	GRM1555C1H6R3DA01D
6.4pF(6R4)	±0.05pF(W)	GRM0225C1C6R4WD05L	GRM0335C1H6R4WD01D	GRM1555C1H6R4WA01D
	±0.1pF(B)	GRM0225C1C6R4BD05L	GRM0335C1H6R4BD01D	GRM1555C1H6R4BA01D
	±0.25pF(C)	GRM0225C1C6R4CD05L	GRM0335C1H6R4CD01D	GRM1555C1H6R4CA01D
	±0.5pF(D)	GRM0225C1C6R4DD05L	GRM0335C1H6R4DD01D	GRM1555C1H6R4DA01D
6.5pF(6R5)	±0.05pF(W)	GRM0225C1C6R5WD05L	GRM0335C1H6R5WD01D	GRM1555C1H6R5WA01D
	±0.1pF(B)	GRM0225C1C6R5BD05L	GRM0335C1H6R5BD01D	GRM1555C1H6R5BA01D
	±0.25pF(C)	GRM0225C1C6R5CD05L	GRM0335C1H6R5CD01D	GRM1555C1H6R5CA01D
	±0.5pF(D)	GRM0225C1C6R5DD05L	GRM0335C1H6R5DD01D	GRM1555C1H6R5DA01D

The part number code is shown in () and Unit is shown in []. <>: EIA [inch] Code

1

Temperature Compensating Type C0G(5C) Characteristics

LxW [mm]		0.4x0.2(02)<01005>	0.6x0.3(03)<0201>	1.0x0.5(15)<0402>
Rated Volt. [Vdc]		16(1C)	50(1H)	50(1H)
Capacitance	Tolerance	Part Number		
6.6pF(6R6)	±0.05pF(W)	GRM0225C1C6R6WD05L	GRM0335C1H6R6WD01D	GRM1555C1H6R6WA01D
	±0.1pF(B)	GRM0225C1C6R6BD05L	GRM0335C1H6R6BD01D	GRM1555C1H6R6BA01D
	±0.25pF(C)	GRM0225C1C6R6CD05L	GRM0335C1H6R6CD01D	GRM1555C1H6R6CA01D
	±0.5pF(D)	GRM0225C1C6R6DD05L	GRM0335C1H6R6DD01D	GRM1555C1H6R6DA01D
6.7pF(6R7)	±0.05pF(W)	GRM0225C1C6R7WD05L	GRM0335C1H6R7WD01D	GRM1555C1H6R7WA01D
	±0.1pF(B)	GRM0225C1C6R7BD05L	GRM0335C1H6R7BD01D	GRM1555C1H6R7BA01D
	±0.25pF(C)	GRM0225C1C6R7CD05L	GRM0335C1H6R7CD01D	GRM1555C1H6R7CA01D
	±0.5pF(D)	GRM0225C1C6R7DD05L	GRM0335C1H6R7DD01D	GRM1555C1H6R7DA01D
6.8pF(6R8)	±0.05pF(W)	GRM0225C1C6R8WD05L	GRM0335C1H6R8WD01D	GRM1555C1H6R8WA01D
	±0.1pF(B)	GRM0225C1C6R8BD05L	GRM0335C1H6R8BD01D	GRM1555C1H6R8BA01D
	±0.25pF(C)	GRM0225C1C6R8CD05L	GRM0335C1H6R8CD01D	GRM1555C1H6R8CA01D
	±0.5pF(D)	GRM0225C1C6R8DD05L	GRM0335C1H6R8DD01D	GRM1555C1H6R8DA01D
6.9pF(6R9)	±0.05pF(W)	GRM0225C1C6R9WD05L	GRM0335C1H6R9WD01D	GRM1555C1H6R9WA01D
	±0.1pF(B)	GRM0225C1C6R9BD05L	GRM0335C1H6R9BD01D	GRM1555C1H6R9BA01D
	±0.25pF(C)	GRM0225C1C6R9CD05L	GRM0335C1H6R9CD01D	GRM1555C1H6R9CA01D
	±0.5pF(D)	GRM0225C1C6R9DD05L	GRM0335C1H6R9DD01D	GRM1555C1H6R9DA01D
7.0pF(7R0)	±0.05pF(W)	GRM0225C1C7R0WD05L	GRM0335C1H7R0WD01D	GRM1555C1H7R0WA01D
	±0.1pF(B)	GRM0225C1C7R0BD05L	GRM0335C1H7R0BD01D	GRM1555C1H7R0BA01D
	±0.25pF(C)	GRM0225C1C7R0CD05L	GRM0335C1H7R0CD01D	GRM1555C1H7R0CA01D
	±0.5pF(D)	GRM0225C1C7R0DD05L	GRM0335C1H7R0DD01D	GRM1555C1H7R0DA01D
7.1pF(7R1)	±0.05pF(W)	GRM0225C1C7R1WD05L	GRM0335C1H7R1WD01D	GRM1555C1H7R1WA01D
	±0.1pF(B)	GRM0225C1C7R1BD05L	GRM0335C1H7R1BD01D	GRM1555C1H7R1BA01D
	±0.25pF(C)	GRM0225C1C7R1CD05L	GRM0335C1H7R1CD01D	GRM1555C1H7R1CA01D
	±0.5pF(D)	GRM0225C1C7R1DD05L	GRM0335C1H7R1DD01D	GRM1555C1H7R1DA01D
7.2pF(7R2)	±0.05pF(W)	GRM0225C1C7R2WD05L	GRM0335C1H7R2WD01D	GRM1555C1H7R2WA01D
	±0.1pF(B)	GRM0225C1C7R2BD05L	GRM0335C1H7R2BD01D	GRM1555C1H7R2BA01D
	±0.25pF(C)	GRM0225C1C7R2CD05L	GRM0335C1H7R2CD01D	GRM1555C1H7R2CA01D
	±0.5pF(D)	GRM0225C1C7R2DD05L	GRM0335C1H7R2DD01D	GRM1555C1H7R2DA01D
7.3pF(7R3)	±0.05pF(W)	GRM0225C1C7R3WD05L	GRM0335C1H7R3WD01D	GRM1555C1H7R3WA01D
	±0.1pF(B)	GRM0225C1C7R3BD05L	GRM0335C1H7R3BD01D	GRM1555C1H7R3BA01D
	±0.25pF(C)	GRM0225C1C7R3CD05L	GRM0335C1H7R3CD01D	GRM1555C1H7R3CA01D
	±0.5pF(D)	GRM0225C1C7R3DD05L	GRM0335C1H7R3DD01D	GRM1555C1H7R3DA01D
7.4pF(7R4)	±0.05pF(W)	GRM0225C1C7R4WD05L	GRM0335C1H7R4WD01D	GRM1555C1H7R4WA01D
	±0.1pF(B)	GRM0225C1C7R4BD05L	GRM0335C1H7R4BD01D	GRM1555C1H7R4BA01D
	±0.25pF(C)	GRM0225C1C7R4CD05L	GRM0335C1H7R4CD01D	GRM1555C1H7R4CA01D
	±0.5pF(D)	GRM0225C1C7R4DD05L	GRM0335C1H7R4DD01D	GRM1555C1H7R4DA01D
7.5pF(7R5)	±0.05pF(W)	GRM0225C1C7R5WD05L	GRM0335C1H7R5WD01D	GRM1555C1H7R5WA01D
	±0.1pF(B)	GRM0225C1C7R5BD05L	GRM0335C1H7R5BD01D	GRM1555C1H7R5BA01D
	±0.25pF(C)	GRM0225C1C7R5CD05L	GRM0335C1H7R5CD01D	GRM1555C1H7R5CA01D
	±0.5pF(D)	GRM0225C1C7R5DD05L	GRM0335C1H7R5DD01D	GRM1555C1H7R5DA01D
7.6pF(7R6)	±0.05pF(W)	GRM0225C1C7R6WD05L	GRM0335C1H7R6WD01D	GRM1555C1H7R6WA01D
	±0.1pF(B)	GRM0225C1C7R6BD05L	GRM0335C1H7R6BD01D	GRM1555C1H7R6BA01D
	±0.25pF(C)	GRM0225C1C7R6CD05L	GRM0335C1H7R6CD01D	GRM1555C1H7R6CA01D
	±0.5pF(D)	GRM0225C1C7R6DD05L	GRM0335C1H7R6DD01D	GRM1555C1H7R6DA01D
7.7pF(7R7)	±0.05pF(W)	GRM0225C1C7R7WD05L	GRM0335C1H7R7WD01D	GRM1555C1H7R7WA01D
	±0.1pF(B)	GRM0225C1C7R7BD05L	GRM0335C1H7R7BD01D	GRM1555C1H7R7BA01D
	±0.25pF(C)	GRM0225C1C7R7CD05L	GRM0335C1H7R7CD01D	GRM1555C1H7R7CA01D
	±0.5pF(D)	GRM0225C1C7R7DD05L	GRM0335C1H7R7DD01D	GRM1555C1H7R7DA01D

The part number code is shown in () and Unit is shown in []. <->: EIA [inch] Code

(Part Number) GR M 02 2 5C 1C 6R6 W D05 L

1 Product ID 2 Series 3 Dimension (LxW) 4 Dimension (T)

5 Temperature Characteristics 6 Rated Voltage 7 Capacitance

8 Capacitance Tolerance 9 Individual Specification Code 10 Packaging*

Packaging Code in Part Number is a code shows STD 180mm Reel Taping.

*GRM022: D is applicable.

Temperature Compensating Type C0G(5C) Characteristics

LxW [mm]		0.4x0.2(02)<01005>	0.6x0.3(03)<0201>	1.0x0.5(15)<0402>
Rated Volt. [Vdc]		16(1C)	50(1H)	50(1H)
Capacitance	Tolerance	Part Number		
7.8pF(7R8)	±0.05pF(W)	GRM0225C1C7R8WD05L	GRM0335C1H7R8WD01D	GRM1555C1H7R8WA01D
	±0.1pF(B)	GRM0225C1C7R8BD05L	GRM0335C1H7R8BD01D	GRM1555C1H7R8BA01D
	±0.25pF(C)	GRM0225C1C7R8CD05L	GRM0335C1H7R8CD01D	GRM1555C1H7R8CA01D
	±0.5pF(D)	GRM0225C1C7R8DD05L	GRM0335C1H7R8DD01D	GRM1555C1H7R8DA01D
7.9pF(7R9)	±0.05pF(W)	GRM0225C1C7R9WD05L	GRM0335C1H7R9WD01D	GRM1555C1H7R9WA01D
	±0.1pF(B)	GRM0225C1C7R9BD05L	GRM0335C1H7R9BD01D	GRM1555C1H7R9BA01D
	±0.25pF(C)	GRM0225C1C7R9CD05L	GRM0335C1H7R9CD01D	GRM1555C1H7R9CA01D
	±0.5pF(D)	GRM0225C1C7R9DD05L	GRM0335C1H7R9DD01D	GRM1555C1H7R9DA01D
8.0pF(8R0)	±0.05pF(W)	GRM0225C1C8R0WD05L	GRM0335C1H8R0WD01D	GRM1555C1H8R0WA01D
	±0.1pF(B)	GRM0225C1C8R0BD05L	GRM0335C1H8R0BD01D	GRM1555C1H8R0BA01D
	±0.25pF(C)	GRM0225C1C8R0CD05L	GRM0335C1H8R0CD01D	GRM1555C1H8R0CA01D
	±0.5pF(D)	GRM0225C1C8R0DD05L	GRM0335C1H8R0DD01D	GRM1555C1H8R0DA01D
8.1pF(8R1)	±0.05pF(W)	GRM0225C1C8R1WD05L	GRM0335C1H8R1WD01D	GRM1555C1H8R1WA01D
	±0.1pF(B)	GRM0225C1C8R1BD05L	GRM0335C1H8R1BD01D	GRM1555C1H8R1BA01D
	±0.25pF(C)	GRM0225C1C8R1CD05L	GRM0335C1H8R1CD01D	GRM1555C1H8R1CA01D
	±0.5pF(D)	GRM0225C1C8R1DD05L	GRM0335C1H8R1DD01D	GRM1555C1H8R1DA01D
8.2pF(8R2)	±0.05pF(W)	GRM0225C1C8R2WD05L	GRM0335C1H8R2WD01D	GRM1555C1H8R2WA01D
	±0.1pF(B)	GRM0225C1C8R2BD05L	GRM0335C1H8R2BD01D	GRM1555C1H8R2BA01D
	±0.25pF(C)	GRM0225C1C8R2CD05L	GRM0335C1H8R2CD01D	GRM1555C1H8R2CA01D
	±0.5pF(D)	GRM0225C1C8R2DD05L	GRM0335C1H8R2DD01D	GRM1555C1H8R2DA01D
8.3pF(8R3)	±0.05pF(W)	GRM0225C1C8R3WD05L	GRM0335C1H8R3WD01D	GRM1555C1H8R3WA01D
	±0.1pF(B)	GRM0225C1C8R3BD05L	GRM0335C1H8R3BD01D	GRM1555C1H8R3BA01D
	±0.25pF(C)	GRM0225C1C8R3CD05L	GRM0335C1H8R3CD01D	GRM1555C1H8R3CA01D
	±0.5pF(D)	GRM0225C1C8R3DD05L	GRM0335C1H8R3DD01D	GRM1555C1H8R3DA01D
8.4pF(8R4)	±0.05pF(W)	GRM0225C1C8R4WD05L	GRM0335C1H8R4WD01D	GRM1555C1H8R4WA01D
	±0.1pF(B)	GRM0225C1C8R4BD05L	GRM0335C1H8R4BD01D	GRM1555C1H8R4BA01D
	±0.25pF(C)	GRM0225C1C8R4CD05L	GRM0335C1H8R4CD01D	GRM1555C1H8R4CA01D
	±0.5pF(D)	GRM0225C1C8R4DD05L	GRM0335C1H8R4DD01D	GRM1555C1H8R4DA01D
8.5pF(8R5)	±0.05pF(W)	GRM0225C1C8R5WD05L	GRM0335C1H8R5WD01D	GRM1555C1H8R5WA01D
	±0.1pF(B)	GRM0225C1C8R5BD05L	GRM0335C1H8R5BD01D	GRM1555C1H8R5BA01D
	±0.25pF(C)	GRM0225C1C8R5CD05L	GRM0335C1H8R5CD01D	GRM1555C1H8R5CA01D
	±0.5pF(D)	GRM0225C1C8R5DD05L	GRM0335C1H8R5DD01D	GRM1555C1H8R5DA01D
8.6pF(8R6)	±0.05pF(W)	GRM0225C1C8R6WD05L	GRM0335C1H8R6WD01D	GRM1555C1H8R6WA01D
	±0.1pF(B)	GRM0225C1C8R6BD05L	GRM0335C1H8R6BD01D	GRM1555C1H8R6BA01D
	±0.25pF(C)	GRM0225C1C8R6CD05L	GRM0335C1H8R6CD01D	GRM1555C1H8R6CA01D
	±0.5pF(D)	GRM0225C1C8R6DD05L	GRM0335C1H8R6DD01D	GRM1555C1H8R6DA01D
8.7pF(8R7)	±0.05pF(W)	GRM0225C1C8R7WD05L	GRM0335C1H8R7WD01D	GRM1555C1H8R7WA01D
	±0.1pF(B)	GRM0225C1C8R7BD05L	GRM0335C1H8R7BD01D	GRM1555C1H8R7BA01D
	±0.25pF(C)	GRM0225C1C8R7CD05L	GRM0335C1H8R7CD01D	GRM1555C1H8R7CA01D
	±0.5pF(D)	GRM0225C1C8R7DD05L	GRM0335C1H8R7DD01D	GRM1555C1H8R7DA01D
8.8pF(8R8)	±0.05pF(W)	GRM0225C1C8R8WD05L	GRM0335C1H8R8WD01D	GRM1555C1H8R8WA01D
	±0.1pF(B)	GRM0225C1C8R8BD05L	GRM0335C1H8R8BD01D	GRM1555C1H8R8BA01D
	±0.25pF(C)	GRM0225C1C8R8CD05L	GRM0335C1H8R8CD01D	GRM1555C1H8R8CA01D
	±0.5pF(D)	GRM0225C1C8R8DD05L	GRM0335C1H8R8DD01D	GRM1555C1H8R8DA01D
8.9pF(8R9)	±0.05pF(W)	GRM0225C1C8R9WD05L	GRM0335C1H8R9WD01D	GRM1555C1H8R9WA01D
	±0.1pF(B)	GRM0225C1C8R9BD05L	GRM0335C1H8R9BD01D	GRM1555C1H8R9BA01D
	±0.25pF(C)	GRM0225C1C8R9CD05L	GRM0335C1H8R9CD01D	GRM1555C1H8R9CA01D
	±0.5pF(D)	GRM0225C1C8R9DD05L	GRM0335C1H8R9DD01D	GRM1555C1H8R9DA01D
9.0pF(9R0)	±0.05pF(W)	GRM0225C1C9R0WD05L	GRM0335C1H9R0WD01D	GRM1555C1H9R0WA01D
	±0.1pF(B)	GRM0225C1C9R0BD05L	GRM0335C1H9R0BD01D	GRM1555C1H9R0BA01D
	±0.25pF(C)	GRM0225C1C9R0CD05L	GRM0335C1H9R0CD01D	GRM1555C1H9R0CA01D
	±0.5pF(D)	GRM0225C1C9R0DD05L	GRM0335C1H9R0DD01D	GRM1555C1H9R0DA01D

The part number code is shown in () and Unit is shown in []. <>: EIA [inch] Code

1

Temperature Compensating Type C0G(5C) Characteristics

LxW [mm]		0.4x0.2(02)<01005>	0.6x0.3(03)<0201>	1.0x0.5(15)<0402>
Rated Volt. [Vdc]		16(1C)	50(1H)	50(1H)
Capacitance	Tolerance	Part Number		
9.1pF(9R1)	±0.05pF(W)	GRM0225C1C9R1WD05L	GRM0335C1H9R1WD01D	GRM1555C1H9R1WA01D
	±0.1pF(B)	GRM0225C1C9R1BD05L	GRM0335C1H9R1BD01D	GRM1555C1H9R1BA01D
	±0.25pF(C)	GRM0225C1C9R1CD05L	GRM0335C1H9R1CD01D	GRM1555C1H9R1CA01D
	±0.5pF(D)	GRM0225C1C9R1DD05L	GRM0335C1H9R1DD01D	GRM1555C1H9R1DA01D
9.2pF(9R2)	±0.05pF(W)	GRM0225C1C9R2WD05L	GRM0335C1H9R2WD01D	GRM1555C1H9R2WA01D
	±0.1pF(B)	GRM0225C1C9R2BD05L	GRM0335C1H9R2BD01D	GRM1555C1H9R2BA01D
	±0.25pF(C)	GRM0225C1C9R2CD05L	GRM0335C1H9R2CD01D	GRM1555C1H9R2CA01D
	±0.5pF(D)	GRM0225C1C9R2DD05L	GRM0335C1H9R2DD01D	GRM1555C1H9R2DA01D
9.3pF(9R3)	±0.05pF(W)	GRM0225C1C9R3WD05L	GRM0335C1H9R3WD01D	GRM1555C1H9R3WA01D
	±0.1pF(B)	GRM0225C1C9R3BD05L	GRM0335C1H9R3BD01D	GRM1555C1H9R3BA01D
	±0.25pF(C)	GRM0225C1C9R3CD05L	GRM0335C1H9R3CD01D	GRM1555C1H9R3CA01D
	±0.5pF(D)	GRM0225C1C9R3DD05L	GRM0335C1H9R3DD01D	GRM1555C1H9R3DA01D
9.4pF(9R4)	±0.05pF(W)	GRM0225C1C9R4WD05L	GRM0335C1H9R4WD01D	GRM1555C1H9R4WA01D
	±0.1pF(B)	GRM0225C1C9R4BD05L	GRM0335C1H9R4BD01D	GRM1555C1H9R4BA01D
	±0.25pF(C)	GRM0225C1C9R4CD05L	GRM0335C1H9R4CD01D	GRM1555C1H9R4CA01D
	±0.5pF(D)	GRM0225C1C9R4DD05L	GRM0335C1H9R4DD01D	GRM1555C1H9R4DA01D
9.5pF(9R5)	±0.05pF(W)	GRM0225C1C9R5WD05L	GRM0335C1H9R5WD01D	GRM1555C1H9R5WA01D
	±0.1pF(B)	GRM0225C1C9R5BD05L	GRM0335C1H9R5BD01D	GRM1555C1H9R5BA01D
	±0.25pF(C)	GRM0225C1C9R5CD05L	GRM0335C1H9R5CD01D	GRM1555C1H9R5CA01D
	±0.5pF(D)	GRM0225C1C9R5DD05L	GRM0335C1H9R5DD01D	GRM1555C1H9R5DA01D
9.6pF(9R6)	±0.05pF(W)	GRM0225C1C9R6WD05L	GRM0335C1H9R6WD01D	GRM1555C1H9R6WA01D
	±0.1pF(B)	GRM0225C1C9R6BD05L	GRM0335C1H9R6BD01D	GRM1555C1H9R6BA01D
	±0.25pF(C)	GRM0225C1C9R6CD05L	GRM0335C1H9R6CD01D	GRM1555C1H9R6CA01D
	±0.5pF(D)	GRM0225C1C9R6DD05L	GRM0335C1H9R6DD01D	GRM1555C1H9R6DA01D
9.7pF(9R7)	±0.05pF(W)	GRM0225C1C9R7WD05L	GRM0335C1H9R7WD01D	GRM1555C1H9R7WA01D
	±0.1pF(B)	GRM0225C1C9R7BD05L	GRM0335C1H9R7BD01D	GRM1555C1H9R7BA01D
	±0.25pF(C)	GRM0225C1C9R7CD05L	GRM0335C1H9R7CD01D	GRM1555C1H9R7CA01D
	±0.5pF(D)	GRM0225C1C9R7DD05L	GRM0335C1H9R7DD01D	GRM1555C1H9R7DA01D
9.8pF(9R8)	±0.05pF(W)	GRM0225C1C9R8WD05L	GRM0335C1H9R8WD01D	GRM1555C1H9R8WA01D
	±0.1pF(B)	GRM0225C1C9R8BD05L	GRM0335C1H9R8BD01D	GRM1555C1H9R8BA01D
	±0.25pF(C)	GRM0225C1C9R8CD05L	GRM0335C1H9R8CD01D	GRM1555C1H9R8CA01D
	±0.5pF(D)	GRM0225C1C9R8DD05L	GRM0335C1H9R8DD01D	GRM1555C1H9R8DA01D
9.9pF(9R9)	±0.05pF(W)	GRM0225C1C9R9WD05L	GRM0335C1H9R9WD01D	GRM1555C1H9R9WA01D
	±0.1pF(B)	GRM0225C1C9R9BD05L	GRM0335C1H9R9BD01D	GRM1555C1H9R9BA01D
	±0.25pF(C)	GRM0225C1C9R9CD05L	GRM0335C1H9R9CD01D	GRM1555C1H9R9CA01D
	±0.5pF(D)	GRM0225C1C9R9DD05L	GRM0335C1H9R9DD01D	GRM1555C1H9R9DA01D

The part number code is shown in () and Unit is shown in []. <->: EIA [inch] Code

(Part Number) **GR** **M** **02** **2** **5C** **1C** **9R1** **W** **D05** **L**

① Product ID ② Series
 ⑤ Temperature Characteristics ⑥ Rated Voltage ⑦ Capacitance
 ⑧ Capacitance Tolerance ⑨ Individual Specification Code ⑩ Packaging*

Packaging Code in Part Number is a code shows STD 180mm Reel Taping.

*GRM022: D is applicable.

Temperature Compensating Type C0G(5C) Characteristics

LxW [mm]		0.4x0.2(02)<01005>			0.6x0.3(03)<0201>
Rated Volt. [Vdc]		16(1C)	10(1A)	6.3(0J)	50(1H)
Capacitance	Tolerance	Part Number			
10pF(100)	±2%(G)	GRM0225C1C100GD05L			GRM0335C1H100GD01D
	±5%(J)	GRM0225C1C100JD05L			GRM0335C1H100JD01D
12pF(120)	±2%(G)	GRM0225C1C120GD05L			GRM0335C1H120GD01D
	±5%(J)	GRM0225C1C120JD05L			GRM0335C1H120JD01D
15pF(150)	±2%(G)	GRM0225C1C150GD05L			GRM0335C1H150GD01D
	±5%(J)	GRM0225C1C150JD05L			GRM0335C1H150JD01D
18pF(180)	±2%(G)	GRM0225C1C180GD05L			GRM0335C1H180GD01D
	±5%(J)	GRM0225C1C180JD05L			GRM0335C1H180JD01D
22pF(220)	±2%(G)	GRM0225C1C220GD05L			GRM0335C1H220GD01D
	±5%(J)	GRM0225C1C220JD05L			GRM0335C1H220JD01D
27pF(270)	±2%(G)	GRM0225C1C270GD05L			GRM0335C1H270GD01D
	±5%(J)	GRM0225C1C270JD05L			GRM0335C1H270JD01D
33pF(330)	±2%(G)	GRM0225C1C330GD05L			GRM0335C1H330GD01D
	±5%(J)	GRM0225C1C330JD05L			GRM0335C1H330JD01D
39pF(390)	±2%(G)	GRM0225C1C390GD05L			GRM0335C1H390GD01D
	±5%(J)	GRM0225C1C390JD05L			GRM0335C1H390JD01D
47pF(470)	±2%(G)	GRM0225C1C470GD05L			GRM0335C1H470GD01D
	±5%(J)	GRM0225C1C470JD05L			GRM0335C1H470JD01D
56pF(560)	±2%(G)		GRM0225C1A560GD05L	GRM0225C0J560GD05L	GRM0335C1H560GD01D
	±5%(J)		GRM0225C1A560JD05L	GRM0225C0J560JD05L	GRM0335C1H560JD01D
68pF(680)	±2%(G)		GRM0225C1A680GD05L	GRM0225C0J680GD05L	GRM0335C1H680GD01D
	±5%(J)		GRM0225C1A680JD05L	GRM0225C0J680JD05L	GRM0335C1H680JD01D
82pF(820)	±2%(G)		GRM0225C1A820GD05L	GRM0225C0J820GD05L	GRM0335C1H820GD01D
	±5%(J)		GRM0225C1A820JD05L	GRM0225C0J820JD05L	GRM0335C1H820JD01D
100pF(101)	±2%(G)		GRM0225C1A101GD05L	GRM0225C0J101GD05L	GRM0335C1H101GD01D
	±5%(J)		GRM0225C1A101JD05L	GRM0225C0J101JD05L	GRM0335C1H101JD01D

The part number code is shown in () and Unit is shown in []. < >: EIA [inch] Code

1

Temperature Compensating Type C0G(5C) Characteristics

LxW [mm]		1.0x0.5(15)<0402>
Rated Volt. [Vdc]		50(1H)
TC		C0G(5C)
Capacitance	Tolerance	Part Number
10pF(100)	±2%(G)	GRM1555C1H100GA01D
	±5%(J)	GRM1555C1H100JA01D
12pF(120)	±2%(G)	GRM1555C1H120GA01D
	±5%(J)	GRM1555C1H120JA01D
15pF(150)	±2%(G)	GRM1555C1H150GA01D
	±5%(J)	GRM1555C1H150JA01D
18pF(180)	±2%(G)	GRM1555C1H180GA01D
	±5%(J)	GRM1555C1H180JA01D
22pF(220)	±2%(G)	GRM1555C1H220GA01D
	±5%(J)	GRM1555C1H220JA01D
27pF(270)	±2%(G)	GRM1555C1H270GA01D
	±5%(J)	GRM1555C1H270JA01D
33pF(330)	±2%(G)	GRM1555C1H330GA01D
	±5%(J)	GRM1555C1H330JA01D
39pF(390)	±2%(G)	GRM1555C1H390GA01D
	±5%(J)	GRM1555C1H390JA01D
47pF(470)	±2%(G)	GRM1555C1H470GA01D
	±5%(J)	GRM1555C1H470JA01D
56pF(560)	±2%(G)	GRM1555C1H560GA01D
	±5%(J)	GRM1555C1H560JA01D
68pF(680)	±2%(G)	GRM1555C1H680GA01D
	±5%(J)	GRM1555C1H680JA01D
82pF(820)	±2%(G)	GRM1555C1H820GA01D
	±5%(J)	GRM1555C1H820JA01D
100pF(101)	±2%(G)	GRM1555C1H101GA01D
	±5%(J)	GRM1555C1H101JA01D
120pF(121)	±2%(G)	GRM1555C1H121GA01D
	±5%(J)	GRM1555C1H121JA01D
150pF(151)	±2%(G)	GRM1555C1H151GA01D
	±5%(J)	GRM1555C1H151JA01D
180pF(181)	±2%(G)	GRM1555C1H181GA01D
	±5%(J)	GRM1555C1H181JA01D
220pF(221)	±2%(G)	GRM1555C1H221GA01D
	±5%(J)	GRM1555C1H221JA01D
270pF(271)	±2%(G)	GRM1555C1H271GA01D
	±5%(J)	GRM1555C1H271JA01D
330pF(331)	±2%(G)	GRM1555C1H331GA01D
	±5%(J)	GRM1555C1H331JA01D
390pF(391)	±2%(G)	GRM1555C1H391GA01D
	±5%(J)	GRM1555C1H391JA01D
470pF(471)	±2%(G)	GRM1555C1H471GA01D
	±5%(J)	GRM1555C1H471JA01D
560pF(561)	±2%(G)	GRM1555C1H561GA01D
	±5%(J)	GRM1555C1H561JA01D
680pF(681)	±2%(G)	GRM1555C1H681GA01D
	±5%(J)	GRM1555C1H681JA01D
820pF(821)	±2%(G)	GRM1555C1H821GA01D
	±5%(J)	GRM1555C1H821JA01D
1000pF(102)	±2%(G)	GRM1555C1H102GA01D
	±5%(J)	GRM1555C1H102JA01D

The part number code is shown in () and Unit is shown in []. < >: EIA [inch] Code

(Part Number) **GR** **M** **15** **5** **5C** **1H** **100** **G** **Z01** **D**
 ① ② ③ ④ ⑤ ⑥ ⑦ ⑧ ⑨ ⑩

① Product ID
 ② Series
 ⑤ Temperature Characteristics
 ⑥ Capacitance Tolerance

③ Dimension (LxW)
 ④ Dimension (T)
 ⑥ Rated Voltage
 ⑦ Capacitance
 ⑨ Individual Specification Code

④ Dimension (T)
 ⑦ Capacitance
 ⑩ Packaging

Packaging Code in Part Number is a code shows STD 180mm Reel Taping.

Temperature Compensating Type C0G(5C) Characteristics

LxW [mm]		1.6x0.8(18)<0603>	
Rated Volt. [Vdc]		100(2A)	50(1H)
Capacitance	Tolerance	Part Number	
10pF(100)	±5%(J)	GRM1885C2A100JA01D	GRM1885C1H100JA01D
12pF(120)	±5%(J)	GRM1885C2A120JA01D	GRM1885C1H120JA01D
15pF(150)	±5%(J)	GRM1885C2A150JA01D	GRM1885C1H150JA01D
18pF(180)	±5%(J)	GRM1885C2A180JA01D	GRM1885C1H180JA01D
22pF(220)	±5%(J)	GRM1885C2A220JA01D	GRM1885C1H220JA01D
27pF(270)	±5%(J)	GRM1885C2A270JA01D	GRM1885C1H270JA01D
33pF(330)	±5%(J)	GRM1885C2A330JA01D	GRM1885C1H330JA01D
39pF(390)	±5%(J)	GRM1885C2A390JA01D	GRM1885C1H390JA01D
47pF(470)	±5%(J)	GRM1885C2A470JA01D	GRM1885C1H470JA01D
56pF(560)	±5%(J)	GRM1885C2A560JA01D	GRM1885C1H560JA01D
68pF(680)	±5%(J)	GRM1885C2A680JA01D	GRM1885C1H680JA01D
82pF(820)	±5%(J)	GRM1885C2A820JA01D	GRM1885C1H820JA01D
100pF(101)	±5%(J)	GRM1885C2A101JA01D	GRM1885C1H101JA01D
120pF(121)	±5%(J)	GRM1885C2A121JA01D	GRM1885C1H121JA01D
150pF(151)	±5%(J)	GRM1885C2A151JA01D	GRM1885C1H151JA01D
180pF(181)	±5%(J)	GRM1885C2A181JA01D	GRM1885C1H181JA01D
220pF(221)	±5%(J)	GRM1885C2A221JA01D	GRM1885C1H221JA01D
270pF(271)	±5%(J)	GRM1885C2A271JA01D	GRM1885C1H271JA01D
330pF(331)	±5%(J)	GRM1885C2A331JA01D	GRM1885C1H331JA01D
390pF(391)	±5%(J)	GRM1885C2A391JA01D	GRM1885C1H391JA01D
470pF(471)	±5%(J)	GRM1885C2A471JA01D	GRM1885C1H471JA01D
560pF(561)	±5%(J)	GRM1885C2A561JA01D	GRM1885C1H561JA01D
680pF(681)	±5%(J)	GRM1885C2A681JA01D	GRM1885C1H681JA01D
820pF(821)	±5%(J)	GRM1885C2A821JA01D	GRM1885C1H821JA01D
1000pF(102)	±5%(J)	GRM1885C2A102JA01D	GRM1885C1H102JA01D
1200pF(122)	±5%(J)	GRM1885C2A122JA01D	GRM1885C1H122JA01D
1500pF(152)	±5%(J)	GRM1885C2A152JA01D	GRM1885C1H152JA01D
1800pF(182)	±5%(J)		GRM1885C1H182JA01D
2200pF(222)	±5%(J)		GRM1885C1H222JA01D
2700pF(272)	±5%(J)		GRM1885C1H272JA01D
3300pF(332)	±5%(J)		GRM1885C1H332JA01D
3900pF(392)	±5%(J)		GRM1885C1H392JA01D

The part number code is shown in () and Unit is shown in []. < >: EIA [inch] Code

1

Temperature Compensating Type C0G(5C) Characteristics

LxW [mm]		2.0x1.25(21)<0805>		3.2x1.6(31)<1206>	
Rated Volt. [Vdc]		100(2A)	50(1H)	100(2A)	50(1H)
Capacitance	Tolerance	Part Number			
100pF(101)	±5%(J)	GRM2165C2A101JA01D			
120pF(121)	±5%(J)	GRM2165C2A121JA01D			
150pF(151)	±5%(J)	GRM2165C2A151JA01D			
180pF(181)	±5%(J)	GRM2165C2A181JA01D			
220pF(221)	±5%(J)	GRM2165C2A221JA01D			
270pF(271)	±5%(J)	GRM2165C2A271JA01D			
330pF(331)	±5%(J)	GRM2165C2A331JA01D			
390pF(391)	±5%(J)	GRM2165C2A391JA01D			
470pF(471)	±5%(J)	GRM2165C2A471JA01D			
560pF(561)	±5%(J)	GRM2165C2A561JA01D			
680pF(681)	±5%(J)	GRM2165C2A681JA01D			
820pF(821)	±5%(J)	GRM2165C2A821JA01D			
1000pF(102)	±5%(J)	GRM2165C2A102JA01D			
1200pF(122)	±5%(J)	GRM2165C2A122JA01D	GRM2165C1H122JA01D		
1500pF(152)	±5%(J)	GRM2165C2A152JA01D	GRM2165C1H152JA01D		
1800pF(182)	±5%(J)	GRM2165C2A182JA01D	GRM2165C1H182JA01D	GRM3195C2A182JA01D	
2200pF(222)	±5%(J)	GRM2165C2A222JA01D	GRM2165C1H222JA01D	GRM3195C2A222JA01D	
2700pF(272)	±5%(J)	GRM2165C2A272JA01D	GRM2165C1H272JA01D	GRM3195C2A272JA01D	
3300pF(332)	±5%(J)	GRM2165C2A332JA01D	GRM2165C1H332JA01D	GRM3195C2A332JA01D	
3900pF(392)	±5%(J)		GRM2165C1H392JA01D	GRM3195C2A392JA01D	
4700pF(472)	±5%(J)		GRM2165C1H472JA01D	GRM3195C2A472JA01D	GRM3195C1H472JA01D
5600pF(562)	±5%(J)		GRM2195C1H562JA01D	GRM3195C2A562JA01D	GRM3195C1H562JA01D
6800pF(682)	±5%(J)		GRM2195C1H682JA01D	GRM3195C2A682JA01D	GRM3195C1H682JA01D
8200pF(822)	±5%(J)		GRM2195C1H822JA01D	GRM3195C2A822JA01D	GRM3195C1H822JA01D
10000pF(103)	±5%(J)		GRM2195C1H103JA01D	GRM3195C2A103JA01D	GRM3195C1H103JA01D
12000pF(123)	±5%(J)		GRM2195C1H123JA01D		GRM3195C1H123JA01D
15000pF(153)	±5%(J)		GRM2195C1H153JA01D		GRM3195C1H153JA01D
18000pF(183)	±5%(J)		GRM21B5C1H183JA01L		GRM3195C1H183JA01D
22000pF(223)	±5%(J)		GRM21B5C1H223JA01L		GRM3195C1H223JA01D
27000pF(273)	±5%(J)				GRM3195C1H273JA01D
33000pF(333)	±5%(J)				GRM3195C1H333JA01D
39000pF(393)	±5%(J)				GRM3195C1H393JA01D
47000pF(473)	±5%(J)				GRM31M5C1H473JA01L
56000pF(563)	±5%(J)				GRM31M5C1H563JA01L
68000pF(683)	±5%(J)				GRM31C5C1H683JA01L
82000pF(823)	±5%(J)				GRM31C5C1H823JA01L
100000pF(104)	±5%(J)				GRM31C5C1H104JA01L

The part number code is shown in () and Unit is shown in []. <->: EIA [inch] Code

(Part Number) **GR** **M** **21** **6** **5C** **2A** **101** **J** **A01** **D**
 ① Product ID ② Series ③ Dimension (LxW) ④ Dimension (T)
 ⑤ Temperature Characteristics ⑥ Rated Voltage ⑦ Capacitance
 ⑧ Capacitance Tolerance ⑨ Individual Specification Code ⑩ Packaging

Packaging Code in Part Number is a code shows STD 180mm Reel Taping.

Temperature Compensating Type C0G(5C) Characteristics Low Profile

LxW [mm]		1.0x0.5(15)<0402>
Rated Volt. [Vdc]		50(1H)
Capacitance	Tolerance	Part Number
0.1pF(R10)	±0.1pF(B)	GRM1535C1HR10BDD5D
0.2pF(R20)	±0.1pF(B)	GRM1535C1HR20BDD5D
0.3pF(R30)	±0.1pF(B)	GRM1535C1HR30BDD5D
0.4pF(R40)	±0.1pF(B)	GRM1535C1HR40BDD5D
0.5pF(R50)	±0.1pF(B)	GRM1535C1HR50BDD5D
0.6pF(R60)	±0.1pF(B)	GRM1535C1HR60BDD5D
0.7pF(R70)	±0.1pF(B)	GRM1535C1HR70BDD5D
0.8pF(R80)	±0.1pF(B)	GRM1535C1HR80BDD5D
0.9pF(R90)	±0.1pF(B)	GRM1535C1HR90BDD5D
1.0pF(1R0)	±0.25pF(C)	GRM1535C1H1R0CDD5D
1.1pF(1R1)	±0.25pF(C)	GRM1535C1H1R1CDD5D
1.2pF(1R2)	±0.25pF(C)	GRM1535C1H1R2CDD5D
1.3pF(1R3)	±0.25pF(C)	GRM1535C1H1R3CDD5D
1.4pF(1R4)	±0.25pF(C)	GRM1535C1H1R4CDD5D
1.5pF(1R5)	±0.25pF(C)	GRM1535C1H1R5CDD5D
1.6pF(1R6)	±0.25pF(C)	GRM1535C1H1R6CDD5D
1.7pF(1R7)	±0.25pF(C)	GRM1535C1H1R7CDD5D
1.8pF(1R8)	±0.25pF(C)	GRM1535C1H1R8CDD5D
1.9pF(1R9)	±0.25pF(C)	GRM1535C1H1R9CDD5D
2.0pF(2R0)	±0.25pF(C)	GRM1535C1H2R0CDD5D
2.1pF(2R1)	±0.25pF(C)	GRM1535C1H2R1CDD5D
2.2pF(2R2)	±0.25pF(C)	GRM1535C1H2R2CDD5D
2.3pF(2R3)	±0.25pF(C)	GRM1535C1H2R3CDD5D
2.4pF(2R4)	±0.25pF(C)	GRM1535C1H2R4CDD5D
2.5pF(2R5)	±0.25pF(C)	GRM1535C1H2R5CDD5D
2.6pF(2R6)	±0.25pF(C)	GRM1535C1H2R6CDD5D
2.7pF(2R7)	±0.25pF(C)	GRM1535C1H2R7CDD5D
2.8pF(2R8)	±0.25pF(C)	GRM1535C1H2R8CDD5D
2.9pF(2R9)	±0.25pF(C)	GRM1535C1H2R9CDD5D
3.0pF(3R0)	±0.25pF(C)	GRM1535C1H3R0CDD5D
3.1pF(3R1)	±0.25pF(C)	GRM1535C1H3R1CDD5D
3.2pF(3R2)	±0.25pF(C)	GRM1535C1H3R2CDD5D
3.3pF(3R3)	±0.25pF(C)	GRM1535C1H3R3CDD5D
3.4pF(3R4)	±0.25pF(C)	GRM1535C1H3R4CDD5D
3.5pF(3R5)	±0.25pF(C)	GRM1535C1H3R5CDD5D
3.6pF(3R6)	±0.25pF(C)	GRM1535C1H3R6CDD5D
3.7pF(3R7)	±0.25pF(C)	GRM1535C1H3R7CDD5D
3.8pF(3R8)	±0.25pF(C)	GRM1535C1H3R8CDD5D
3.9pF(3R9)	±0.25pF(C)	GRM1535C1H3R9CDD5D
4.0pF(4R0)	±0.25pF(C)	GRM1535C1H4R0CDD5D
4.1pF(4R1)	±0.25pF(C)	GRM1535C1H4R1CDD5D
4.2pF(4R2)	±0.25pF(C)	GRM1535C1H4R2CDD5D
4.3pF(4R3)	±0.25pF(C)	GRM1535C1H4R3CDD5D
4.4pF(4R4)	±0.25pF(C)	GRM1535C1H4R4CDD5D
4.5pF(4R5)	±0.25pF(C)	GRM1535C1H4R5CDD5D
4.6pF(4R6)	±0.25pF(C)	GRM1535C1H4R6CDD5D
4.7pF(4R7)	±0.25pF(C)	GRM1535C1H4R7CDD5D
4.8pF(4R8)	±0.25pF(C)	GRM1535C1H4R8CDD5D
4.9pF(4R9)	±0.25pF(C)	GRM1535C1H4R9CDD5D
5.0pF(5R0)	±0.25pF(C)	GRM1535C1H5R0CDD5D

LxW [mm]		1.0x0.5(15)<0402>
Rated Volt. [Vdc]		50(1H)
Capacitance	Tolerance	Part Number
5.1pF(5R1)	±0.5pF(D)	GRM1535C1H5R1DDD5D
5.2pF(5R2)	±0.5pF(D)	GRM1535C1H5R2DDD5D
5.3pF(5R3)	±0.5pF(D)	GRM1535C1H5R3DDD5D
5.4pF(5R4)	±0.5pF(D)	GRM1535C1H5R4DDD5D
5.5pF(5R5)	±0.5pF(D)	GRM1535C1H5R5DDD5D
5.6pF(5R6)	±0.5pF(D)	GRM1535C1H5R6DDD5D
5.7pF(5R7)	±0.5pF(D)	GRM1535C1H5R7DDD5D
5.8pF(5R8)	±0.5pF(D)	GRM1535C1H5R8DDD5D
5.9pF(5R9)	±0.5pF(D)	GRM1535C1H5R9DDD5D
6.0pF(6R0)	±0.5pF(D)	GRM1535C1H6R0DDD5D
6.1pF(6R1)	±0.5pF(D)	GRM1535C1H6R1DDD5D
6.2pF(6R2)	±0.5pF(D)	GRM1535C1H6R2DDD5D
6.3pF(6R3)	±0.5pF(D)	GRM1535C1H6R3DDD5D
6.4pF(6R4)	±0.5pF(D)	GRM1535C1H6R4DDD5D
6.5pF(6R5)	±0.5pF(D)	GRM1535C1H6R5DDD5D
6.6pF(6R6)	±0.5pF(D)	GRM1535C1H6R6DDD5D
6.7pF(6R7)	±0.5pF(D)	GRM1535C1H6R7DDD5D
6.8pF(6R8)	±0.5pF(D)	GRM1535C1H6R8DDD5D
6.9pF(6R9)	±0.5pF(D)	GRM1535C1H6R9DDD5D
7.0pF(7R0)	±0.5pF(D)	GRM1535C1H7R0DDD5D
7.1pF(7R1)	±0.5pF(D)	GRM1535C1H7R1DDD5D
7.2pF(7R2)	±0.5pF(D)	GRM1535C1H7R2DDD5D
7.3pF(7R3)	±0.5pF(D)	GRM1535C1H7R3DDD5D
7.4pF(7R4)	±0.5pF(D)	GRM1535C1H7R4DDD5D
7.5pF(7R5)	±0.5pF(D)	GRM1535C1H7R5DDD5D
7.6pF(7R6)	±0.5pF(D)	GRM1535C1H7R6DDD5D
7.7pF(7R7)	±0.5pF(D)	GRM1535C1H7R7DDD5D
7.8pF(7R8)	±0.5pF(D)	GRM1535C1H7R8DDD5D
7.9pF(7R9)	±0.5pF(D)	GRM1535C1H7R9DDD5D
8.0pF(8R0)	±0.5pF(D)	GRM1535C1H8R0DDD5D
8.1pF(8R1)	±0.5pF(D)	GRM1535C1H8R1DDD5D
8.2pF(8R2)	±0.5pF(D)	GRM1535C1H8R2DDD5D
8.3pF(8R3)	±0.5pF(D)	GRM1535C1H8R3DDD5D
8.4pF(8R4)	±0.5pF(D)	GRM1535C1H8R4DDD5D
8.5pF(8R5)	±0.5pF(D)	GRM1535C1H8R5DDD5D
8.6pF(8R6)	±0.5pF(D)	GRM1535C1H8R6DDD5D
8.7pF(8R7)	±0.5pF(D)	GRM1535C1H8R7DDD5D
8.8pF(8R8)	±0.5pF(D)	GRM1535C1H8R8DDD5D
8.9pF(8R9)	±0.5pF(D)	GRM1535C1H8R9DDD5D
9.0pF(9R0)	±0.5pF(D)	GRM1535C1H9R0DDD5D
9.1pF(9R1)	±0.5pF(D)	GRM1535C1H9R1DDD5D
9.2pF(9R2)	±0.5pF(D)	GRM1535C1H9R2DDD5D
9.3pF(9R3)	±0.5pF(D)	GRM1535C1H9R3DDD5D
9.4pF(9R4)	±0.5pF(D)	GRM1535C1H9R4DDD5D
9.5pF(9R5)	±0.5pF(D)	GRM1535C1H9R5DDD5D
9.6pF(9R6)	±0.5pF(D)	GRM1535C1H9R6DDD5D
9.7pF(9R7)	±0.5pF(D)	GRM1535C1H9R7DDD5D
9.8pF(9R8)	±0.5pF(D)	GRM1535C1H9R8DDD5D
9.9pF(9R9)	±0.5pF(D)	GRM1535C1H9R9DDD5D

The part number code is shown in () and Unit is shown in []. <->: EIA [inch] Code

1

Temperature Compensating Type C0G(5C) Characteristics Low Profile

LxW [mm]		1.0x0.5(15)<0402>
Rated Volt. [Vdc]		50(1H)
Capacitance	Tolerance	Part Number
10pF(100)	±5%(J)	GRM1535C1H100JDD5D
12pF(120)	±5%(J)	GRM1535C1H120JDD5D
15pF(150)	±5%(J)	GRM1535C1H150JDD5D
18pF(180)	±5%(J)	GRM1535C1H180JDD5D
22pF(220)	±5%(J)	GRM1535C1H220JDD5D
27pF(270)	±5%(J)	GRM1535C1H270JDD5D
33pF(330)	±5%(J)	GRM1535C1H330JDD5D
39pF(390)	±5%(J)	GRM1535C1H390JDD5D
47pF(470)	±5%(J)	GRM1535C1H470JDD5D
56pF(560)	±5%(J)	GRM1535C1H560JDD5D
68pF(680)	±5%(J)	GRM1535C1H680JDD5D
82pF(820)	±5%(J)	GRM1535C1H820JDD5D
100pF(101)	±5%(J)	GRM1535C1H101JDD5D
120pF(121)	±5%(J)	GRM1535C1H121JDD5D
150pF(151)	±5%(J)	GRM1535C1H151JDD5D
180pF(181)	±5%(J)	GRM1535C1H181JDD5D
220pF(221)	±5%(J)	GRM1535C1H221JDD5D
270pF(271)	±5%(J)	GRM1535C1H271JDD5D
330pF(331)	±5%(J)	GRM1535C1H331JDD5D
390pF(391)	±5%(J)	GRM1535C1H391JDD5D
470pF(471)	±5%(J)	GRM1535C1H471JDD5D
560pF(561)	±5%(J)	GRM1535C1H561JDD5D
680pF(681)	±5%(J)	GRM1535C1H681JDD5D

The part number code is shown in () and Unit is shown in []. < >: EIA [inch] Code

(Part Number) **GR** **M** **15** **3** **5C** **1H** **100** **J** **DD5** **D**
 ① ② ③ ④ ⑤ ⑥ ⑦ ⑧ ⑨ ⑩

① Product ID ② Series
 ⑤ Temperature Characteristics
 ⑧ Capacitance Tolerance

③ Dimension (LxW)
 ⑥ Rated Voltage
 ⑨ Individual Specification Code

④ Dimension (T)
 ⑦ Capacitance
 ⑩ Packaging

Packaging Code in Part Number is a code shows STD 180mm Reel Taping.

Temperature Compensating Type C0G(5C) Characteristics Low Profile

LxW [mm]		2.0x1.25(21)<0805>		3.2x1.6(31)<1206>	
Rated Volt. [Vdc]		100(2A)	50(1H)	100(2A)	50(1H)
Capacitance	Tolerance	Part Number			
100pF(101)	±5%(J)	GRM2165C2A101JA01D			
120pF(121)	±5%(J)	GRM2165C2A121JA01D			
150pF(151)	±5%(J)	GRM2165C2A151JA01D			
180pF(181)	±5%(J)	GRM2165C2A181JA01D			
220pF(221)	±5%(J)	GRM2165C2A221JA01D			
270pF(271)	±5%(J)	GRM2165C2A271JA01D			
330pF(331)	±5%(J)	GRM2165C2A331JA01D			
390pF(391)	±5%(J)	GRM2165C2A391JA01D			
470pF(471)	±5%(J)	GRM2165C2A471JA01D			
560pF(561)	±5%(J)	GRM2165C2A561JA01D			
680pF(681)	±5%(J)	GRM2165C2A681JA01D			
820pF(821)	±5%(J)	GRM2165C2A821JA01D			
1000pF(102)	±5%(J)	GRM2165C2A102JA01D			
1200pF(122)	±5%(J)	GRM2165C2A122JA01D	GRM2165C1H122JA01D		
1500pF(152)	±5%(J)	GRM2165C2A152JA01D	GRM2165C1H152JA01D		
1800pF(182)	±5%(J)	GRM2165C2A182JA01D	GRM2165C1H182JA01D	GRM3195C2A182JA01D	
2200pF(222)	±5%(J)	GRM2165C2A222JA01D	GRM2165C1H222JA01D	GRM3195C2A222JA01D	
2700pF(272)	±5%(J)	GRM2165C2A272JA01D	GRM2165C1H272JA01D	GRM3195C2A272JA01D	
3300pF(332)	±5%(J)	GRM2165C2A332JA01D	GRM2165C1H332JA01D	GRM3195C2A332JA01D	
3900pF(392)	±5%(J)		GRM2165C1H392JA01D	GRM3195C2A392JA01D	
4700pF(472)	±5%(J)		GRM2165C1H472JA01D	GRM3195C2A472JA01D	GRM3195C1H472JA01D
5600pF(562)	±5%(J)		GRM2195C1H562JA01D	GRM3195C2A562JA01D	GRM3195C1H562JA01D
6800pF(682)	±5%(J)		GRM2195C1H682JA01D	GRM3195C2A682JA01D	GRM3195C1H682JA01D
8200pF(822)	±5%(J)		GRM2195C1H822JA01D	GRM3195C2A822JA01D	GRM3195C1H822JA01D
10000pF(103)	±5%(J)		GRM2195C1H103JA01D	GRM3195C2A103JA01D	GRM3195C1H103JA01D
12000pF(123)	±5%(J)		GRM2195C1H123JA01D		GRM3195C1H123JA01D
15000pF(153)	±5%(J)		GRM2195C1H153JA01D		GRM3195C1H153JA01D
18000pF(183)	±5%(J)				GRM3195C1H183JA01D
22000pF(223)	±5%(J)				GRM3195C1H223JA01D
27000pF(273)	±5%(J)				GRM3195C1H273JA01D
33000pF(333)	±5%(J)				GRM3195C1H333JA01D
39000pF(393)	±5%(J)				GRM3195C1H393JA01D
47000pF(473)	±5%(J)				GRM31M5C1H473JA01L
56000pF(563)	±5%(J)				GRM31M5C1H563JA01L

The part number code is shown in () and Unit is shown in []. <->: EIA [inch] Code

Temperature Compensating Type U2J(7U) Characteristics

LxW [mm]		0.6x0.3(03)<0201>		1.0x0.5(15)<0402>	
Rated Volt. [Vdc]		50(1H)	25(1E)	50(1H)	10(1A)
Capacitance	Tolerance	Part Number			
1.0pF(1R0)	±0.25pF(C)	GRM0337U1H1R0CD01D		GRM1557U1H1R0CZ01D	
2.0pF(2R0)	±0.25pF(C)	GRM0337U1H2R0CD01D		GRM1557U1H2R0CZ01D	
3.0pF(3R0)	±0.25pF(C)	GRM0337U1H3R0CD01D		GRM1557U1H3R0CZ01D	
4.0pF(4R0)	±0.25pF(C)	GRM0337U1H4R0CD01D		GRM1557U1H4R0CZ01D	
5.0pF(5R0)	±0.25pF(C)	GRM0337U1H5R0CD01D		GRM1557U1H5R0CZ01D	
6.0pF(6R0)	±0.5pF(D)	GRM0337U1H6R0DD01D		GRM1557U1H6R0DZ01D	
7.0pF(7R0)	±0.5pF(D)	GRM0337U1H7R0DD01D		GRM1557U1H7R0DZ01D	
8.0pF(8R0)	±0.5pF(D)	GRM0337U1H8R0DD01D		GRM1557U1H8R0DZ01D	
9.0pF(9R0)	±0.5pF(D)	GRM0337U1H9R0DD01D		GRM1557U1H9R0DZ01D	
10pF(100)	±5%(J)	GRM0337U1H100JD01D		GRM1557U1H100JZ01D	
12pF(120)	±5%(J)	GRM0337U1H120JD01D		GRM1557U1H120JZ01D	
15pF(150)	±5%(J)	GRM0337U1H150JD01D		GRM1557U1H150JZ01D	
18pF(180)	±5%(J)		GRM0337U1E180JD01D	GRM1557U1H180JZ01D	
22pF(220)	±5%(J)		GRM0337U1E220JD01D	GRM1557U1H220JZ01D	
27pF(270)	±5%(J)		GRM0337U1E270JD01D	GRM1557U1H270JZ01D	
33pF(330)	±5%(J)		GRM0337U1E330JD01D	GRM1557U1H330JZ01D	
39pF(390)	±5%(J)		GRM0337U1E390JD01D	GRM1557U1H390JZ01D	
47pF(470)	±5%(J)		GRM0337U1E470JD01D	GRM1557U1H470JZ01D	
56pF(560)	±5%(J)		GRM0337U1E560JD01D	GRM1557U1H560JZ01D	
68pF(680)	±5%(J)		GRM0337U1E680JD01D	GRM1557U1H680JZ01D	
82pF(820)	±5%(J)		GRM0337U1E820JD01D	GRM1557U1H820JZ01D	
100pF(101)	±5%(J)		GRM0337U1E101JD01D	GRM1557U1H101JZ01D	
120pF(121)	±5%(J)			GRM1557U1H121JZ01D	
150pF(151)	±5%(J)			GRM1557U1H151JZ01D	
180pF(181)	±5%(J)			GRM1557U1H181JZ01D	
1200pF(122)	±5%(J)				GRM1557U1A122JA01D
1500pF(152)	±5%(J)				GRM1557U1A152JA01D
1800pF(182)	±5%(J)				GRM1557U1A182JA01D
2200pF(222)	±5%(J)				GRM1557U1A222JA01D
2700pF(272)	±5%(J)				GRM1557U1A272JA01D
3300pF(332)	±5%(J)				GRM1557U1A332JA01D
3900pF(392)	±5%(J)				GRM1557U1A392JA01D
4700pF(472)	±5%(J)				GRM1557U1A472JA01D

The part number code is shown in () and Unit is shown in []. <->: EIA [inch] Code

(Part Number) **GR** **M** **03** **3** **7U** **1H** **1R0** **C** **D01** **D**
 ① ② ③ ④ ⑤ ⑥ ⑦ ⑧ ⑨ ⑩

① Product ID ② Series
 ⑤ Temperature Characteristics
 ⑥ Capacitance Tolerance

③ Dimension (LxW)
 ⑥ Rated Voltage
 ⑨ Individual Specification Code

④ Dimension (T)
 ⑦ Capacitance
 ⑩ Packaging

Packaging Code in Part Number is a code shows STD 180mm Reel Taping.

Temperature Compensating Type U2J(7U) Characteristics

LxW [mm]		1.6x0.8(18)<0603>	
Rated Volt. [Vdc]		50(1H)	10(1A)
Capacitance	Tolerance	Part Number	
1000pF(102)	±5%(J)	GRM1887U1H102JA01D	
1200pF(122)	±5%(J)	GRM1887U1H122JA01D	
1500pF(152)	±5%(J)	GRM1887U1H152JA01D	
1800pF(182)	±5%(J)	GRM1887U1H182JA01D	
2200pF(222)	±5%(J)	GRM1887U1H222JA01D	
2700pF(272)	±5%(J)	GRM1887U1H272JA01D	
3300pF(332)	±5%(J)	GRM1887U1H332JA01D	
3900pF(392)	±5%(J)	GRM1887U1H392JA01D	
4700pF(472)	±5%(J)	GRM1887U1H472JA01D	
5600pF(562)	±5%(J)	GRM1887U1H562JA01D	
6800pF(682)	±5%(J)	GRM1887U1H682JA01D	
8200pF(822)	±5%(J)	GRM1887U1H822JA01D	
10000pF(103)	±5%(J)	GRM1887U1H103JA01D	
12000pF(123)	±5%(J)		GRM1887U1A123JA01D
15000pF(153)	±5%(J)		GRM1887U1A153JA01D
18000pF(183)	±5%(J)		GRM1887U1A183JA01D
22000pF(223)	±5%(J)		GRM1887U1A223JA01D

LxW [mm]		2.0x1.25(21)<0805>		3.2x1.6(31)<1206>
Rated Volt. [Vdc]		50(1H)	10(1A)	50(1H)
Capacitance	Tolerance	Part Number		
10000pF(103)	±5%(J)	GRM2167U1H103JA01D		
12000pF(123)	±5%(J)	GRM2167U1H123JA01D		
15000pF(153)	±5%(J)	GRM2167U1H153JA01D		
18000pF(183)	±5%(J)	GRM2167U1H183JA01D		
22000pF(223)	±5%(J)	GRM2197U1H223JA01D		
27000pF(273)	±5%(J)	GRM2197U1H273JA01D		
33000pF(333)	±5%(J)	GRM21A7U1H333JA39L		
39000pF(393)	±5%(J)	GRM21B7U1H393JA01L		
47000pF(473)	±5%(J)	GRM21B7U1H473JA01L		
56000pF(563)	±5%(J)		GRM2197U1A563JA01D	GRM3197U1H563JA01D
68000pF(683)	±5%(J)		GRM21B7U1A683JA01L	GRM31M7U1H683JA01L
82000pF(823)	±5%(J)		GRM21B7U1A823JA01L	GRM31M7U1H823JA01L
100000pF(104)	±5%(J)		GRM21B7U1A104JA01L	GRM31M7U1H104JA01L

The part number code is shown in () and Unit is shown in []. <->: EIA [inch] Code

1

Temperature Compensating Type U2J(7U) Characteristics Low Profile

LxW [mm]		1.6x0.8(18)<0603>	
Rated Volt. [Vdc]		50(1H)	10(1A)
Capacitance	Tolerance	Part Number	
2200pF(222)	±5%(J)	GRM1857U1H222JA44D	
2700pF(272)	±5%(J)	GRM1857U1H272JA44D	
3300pF(332)	±5%(J)	GRM1857U1H332JA44D	
3900pF(392)	±5%(J)	GRM1857U1H392JA44D	
4700pF(472)	±5%(J)	GRM1857U1H472JA44D	
5600pF(562)	±5%(J)	GRM1857U1A562JA44D	
6800pF(682)	±5%(J)	GRM1857U1A682JA44D	
8200pF(822)	±5%(J)	GRM1857U1A822JA44D	
10000pF(103)	±5%(J)	GRM1857U1A103JA44D	

LxW [mm]		2.0x1.25(21)<0805>		3.2x1.6(31)<1206>
Rated Volt. [Vdc]		50(1H)	10(1A)	50(1H)
Capacitance	Tolerance	Part Number		
10000pF(103)	±5%(J)	GRM2167U1H103JA01D		
12000pF(123)	±5%(J)	GRM2167U1H123JA01D		
15000pF(153)	±5%(J)	GRM2167U1H153JA01D		
18000pF(183)	±5%(J)	GRM2167U1H183JA01D		
22000pF(223)	±5%(J)	GRM2197U1H223JA01D		
27000pF(273)	±5%(J)	GRM2197U1H273JA01D		
33000pF(333)	±5%(J)	GRM21A7U1H333JA39L		
56000pF(563)	±5%(J)	GRM2197U1A563JA01D		GRM3197U1H563JA01D
68000pF(683)	±5%(J)	GRM31M7U1H683JA01L		
82000pF(823)	±5%(J)	GRM31M7U1H823JA01L		
100000pF(104)	±5%(J)	GRM31M7U1H104JA01L		

The part number code is shown in () and Unit is shown in []. < >: EIA [inch] Code

(Part Number) **GR** **M** **18** **5** **7U** **1H** **222** **J** **A44** **D**
 ① ② ③ ④ ⑤ ⑥ ⑦ ⑧ ⑨ ⑩

① Product ID ② Series
 ⑤ Temperature Characteristics
 ⑥ Capacitance Tolerance

③ Dimension (LxW)
 ⑥ Rated Voltage
 ⑨ Individual Specification Code

④ Dimension (T)
 ⑦ Capacitance
 ⑩ Packaging

Packaging Code in Part Number is a code shows STD 180mm Reel Taping.

Temperature Compensating Type P2H(6P) Characteristics

LxW [mm]		1.0x0.5(15)<0402>
Rated Volt. [Vdc]		50(1H)
Capacitance	Tolerance	
1.0pF(1R0)	±0.25pF(C)	GRM1556P1H1R0CZ01D
2.0pF(2R0)	±0.25pF(C)	GRM1556P1H2R0CZ01D
3.0pF(3R0)	±0.25pF(C)	GRM1556P1H3R0CZ01D
4.0pF(4R0)	±0.25pF(C)	GRM1556P1H4R0CZ01D
5.0pF(5R0)	±0.25pF(C)	GRM1556P1H5R0CZ01D
6.0pF(6R0)	±0.5pF(D)	GRM1556P1H6R0DZ01D
7.0pF(7R0)	±0.5pF(D)	GRM1556P1H7R0DZ01D
8.0pF(8R0)	±0.5pF(D)	GRM1556P1H8R0DZ01D
9.0pF(9R0)	±0.5pF(D)	GRM1556P1H9R0DZ01D
10pF(100)	±5%(J)	GRM1556P1H100JZ01D
12pF(120)	±5%(J)	GRM1556P1H120JZ01D
15pF(150)	±5%(J)	GRM1556P1H150JZ01D
18pF(180)	±5%(J)	GRM1556P1H180JZ01D
22pF(220)	±5%(J)	GRM1556P1H220JZ01D
27pF(270)	±5%(J)	GRM1556P1H270JZ01D

The part number code is shown in () and Unit is shown in []. <->: EIA [inch] Code

Temperature Compensating Type R2H(6R) Characteristics

LxW [mm]		0.6x0.3(03)<0201>	1.0x0.5(15)<0402>
Rated Volt. [Vdc]		25(1E)	50(1H)
Capacitance	Tolerance	Part Number	
1.0pF(1R0)	±0.25pF(C)	GRM0336R1E1R0CD01D	GRM1556R1H1R0CD01D
2.0pF(2R0)	±0.25pF(C)	GRM0336R1E2R0CD01D	GRM1556R1H2R0CZ01D
3.0pF(3R0)	±0.25pF(C)	GRM0336R1E3R0CD01D	GRM1556R1H3R0CZ01D
4.0pF(4R0)	±0.25pF(C)	GRM0336R1E4R0CD01D	GRM1556R1H4R0CZ01D
5.0pF(5R0)	±0.25pF(C)	GRM0336R1E5R0CD01D	GRM1556R1H5R0CZ01D
6.0pF(6R0)	±0.5pF(D)	GRM0336R1E6R0DD01D	GRM1556R1H6R0DZ01D
7.0pF(7R0)	±0.5pF(D)	GRM0336R1E7R0DD01D	GRM1556R1H7R0DZ01D
8.0pF(8R0)	±0.5pF(D)	GRM0336R1E8R0DD01D	GRM1556R1H8R0DZ01D
9.0pF(9R0)	±0.5pF(D)	GRM0336R1E9R0DD01D	GRM1556R1H9R0DZ01D
10pF(100)	±5%(J)	GRM0336R1E100JD01D	GRM1556R1H100JZ01D
12pF(120)	±5%(J)	GRM0336R1E120JD01D	GRM1556R1H120JZ01D
15pF(150)	±5%(J)	GRM0336R1E150JD01D	GRM1556R1H150JZ01D
18pF(180)	±5%(J)	GRM0336R1E180JD01D	GRM1556R1H180JZ01D
22pF(220)	±5%(J)	GRM0336R1E220JD01D	GRM1556R1H220JZ01D
27pF(270)	±5%(J)	GRM0336R1E270JD01D	GRM1556R1H270JZ01D
33pF(330)	±5%(J)	GRM0336R1E330JD01D	GRM1556R1H330JZ01D
39pF(390)	±5%(J)	GRM0336R1E390JD01D	
47pF(470)	±5%(J)	GRM0336R1E470JD01D	
56pF(560)	±5%(J)	GRM0336R1E560JD01D	
68pF(680)	±5%(J)	GRM0336R1E680JD01D	
82pF(820)	±5%(J)	GRM0336R1E820JD01D	
100pF(101)	±5%(J)	GRM0336R1E101JD01D	

The part number code is shown in () and Unit is shown in []. <->: EIA [inch] Code

1

Temperature Compensating Type S2H(6S) Characteristics

LxW [mm]		0.6x0.3(03)<0201>	1.0x0.5(15)<0402>
Rated Volt. [Vdc]		25(1E)	50(1H)
Capacitance	Tolerance	Part Number	
1.0pF(1R0)	±0.25pF(C)	GRM0336S1E1R0CD01D	GRM1556S1H1R0CD01D
2.0pF(2R0)	±0.25pF(C)	GRM0336S1E2R0CD01D	GRM1556S1H2R0CZ01D
3.0pF(3R0)	±0.25pF(C)	GRM0336S1E3R0CD01D	GRM1556S1H3R0CZ01D
4.0pF(4R0)	±0.25pF(C)	GRM0336S1E4R0CD01D	GRM1556S1H4R0CZ01D
5.0pF(5R0)	±0.25pF(C)	GRM0336S1E5R0CD01D	GRM1556S1H5R0CZ01D
6.0pF(6R0)	±0.5pF(D)	GRM0336S1E6R0DD01D	GRM1556S1H6R0DZ01D
7.0pF(7R0)	±0.5pF(D)	GRM0336S1E7R0DD01D	GRM1556S1H7R0DZ01D
8.0pF(8R0)	±0.5pF(D)	GRM0336S1E8R0DD01D	GRM1556S1H8R0DZ01D
9.0pF(9R0)	±0.5pF(D)	GRM0336S1E9R0DD01D	GRM1556S1H9R0DZ01D
10pF(100)	±5%(J)	GRM0336S1E100JD01D	GRM1556S1H100JZ01D
12pF(120)	±5%(J)	GRM0336S1E120JD01D	GRM1556S1H120JZ01D
15pF(150)	±5%(J)	GRM0336S1E150JD01D	GRM1556S1H150JZ01D
18pF(180)	±5%(J)	GRM0336S1E180JD01D	GRM1556S1H180JZ01D
22pF(220)	±5%(J)	GRM0336S1E220JD01D	GRM1556S1H220JZ01D
27pF(270)	±5%(J)	GRM0336S1E270JD01D	GRM1556S1H270JZ01D
33pF(330)	±5%(J)	GRM0336S1E330JD01D	GRM1556S1H330JZ01D
39pF(390)	±5%(J)	GRM0336S1E390JD01D	GRM1556S1H390JZ01D
47pF(470)	±5%(J)	GRM0336S1E470JD01D	
56pF(560)	±5%(J)	GRM0336S1E560JD01D	
68pF(680)	±5%(J)	GRM0336S1E680JD01D	
82pF(820)	±5%(J)	GRM0336S1E820JD01D	
100pF(101)	±5%(J)	GRM0336S1E101JD01D	

The part number code is shown in () and Unit is shown in []. < >: EIA [inch] Code

(Part Number) **GR** **M** **03** **3** **6S** **1E** **1R0** **C** **D01** **D**
 ① ② ③ ④ ⑤ ⑥ ⑦ ⑧ ⑨ ⑩

① Product ID ② Series
 ⑤ Temperature Characteristics
 ⑥ Capacitance Tolerance

③ Dimension (LxW)
 ⑥ Rated Voltage
 ⑨ Individual Specification Code

④ Dimension (T)
 ⑦ Capacitance
 ⑩ Packaging

Packaging Code in Part Number is a code shows STD 180mm Reel Taping.

Temperature Compensating Type T2H(6T) Characteristics

LxW [mm]		0.6x0.3(03)<0201>	1.0x0.5(15)<0402>
Rated Volt. [Vdc]		25(1E)	50(1H)
Capacitance	Tolerance	Part Number	
1.0pF(1R0)	±0.25pF(C)	GRM0336T1E1R0CD01D	GRM1556T1H1R0CD01D
2.0pF(2R0)	±0.25pF(C)	GRM0336T1E2R0CD01D	GRM1556T1H2R0CD01D
3.0pF(3R0)	±0.25pF(C)	GRM0336T1E3R0CD01D	GRM1556T1H3R0CD01D
4.0pF(4R0)	±0.25pF(C)	GRM0336T1E4R0CD01D	GRM1556T1H4R0CD01D
5.0pF(5R0)	±0.25pF(C)	GRM0336T1E5R0CD01D	GRM1556T1H5R0CD01D
6.0pF(6R0)	±0.5pF(D)	GRM0336T1E6R0DD01D	GRM1556T1H6R0DD01D
7.0pF(7R0)	±0.5pF(D)	GRM0336T1E7R0DD01D	GRM1556T1H7R0DD01D
8.0pF(8R0)	±0.5pF(D)	GRM0336T1E8R0DD01D	GRM1556T1H8R0DD01D
9.0pF(9R0)	±0.5pF(D)	GRM0336T1E9R0DD01D	GRM1556T1H9R0DD01D
10pF(100)	±5%(J)	GRM0336T1E100JD01D	GRM1556T1H100JD01D
12pF(120)	±5%(J)	GRM0336T1E120JD01D	GRM1556T1H120JD01D
15pF(150)	±5%(J)	GRM0336T1E150JD01D	GRM1556T1H150JD01D
18pF(180)	±5%(J)	GRM0336T1E180JD01D	GRM1556T1H180JD01D
22pF(220)	±5%(J)	GRM0336T1E220JD01D	GRM1556T1H220JD01D
27pF(270)	±5%(J)	GRM0336T1E270JD01D	GRM1556T1H270JD01D
33pF(330)	±5%(J)	GRM0336T1E330JD01D	GRM1556T1H330JD01D
39pF(390)	±5%(J)	GRM0336T1E390JD01D	GRM1556T1H390JD01D
47pF(470)	±5%(J)	GRM0336T1E470JD01D	GRM1556T1H470JD01D
56pF(560)	±5%(J)	GRM0336T1E560JD01D	GRM1556T1H560JD01D
68pF(680)	±5%(J)	GRM0336T1E680JD01D	GRM1556T1H680JD01D
82pF(820)	±5%(J)	GRM0336T1E820JD01D	GRM1556T1H820JD01D
100pF(101)	±5%(J)	GRM0336T1E101JD01D	GRM1556T1H101JD01D

The part number code is shown in () and Unit is shown in []. <->: EIA [inch] Code

1

High Dielectric Constant Type X7R(R7) Characteristics

LxW [mm]		0.4x0.2(02)<01005>
Rated Volt. [Vdc]		10(1A)
Capacitance	Tolerance	Part Number
68pF(680)	±10%(K)	GRM022R71A680KA01L
100pF(101)	±10%(K)	GRM022R71A101KA01L
150pF(151)	±10%(K)	GRM022R71A151KA01L
220pF(221)	±10%(K)	GRM022R71A221KA01L
330pF(331)	±10%(K)	GRM022R71A331KA01L
470pF(471)	±10%(K)	GRM022R71A471KA01L

LxW [mm]		0.6x0.3(03)<0201>		
Rated Volt. [Vdc]		25(1E)	16(1C)	10(1A)
Capacitance	Tolerance	Part Number		
100pF(101)	±10%(K)	GRM033R71E101KA01D		
150pF(151)	±10%(K)	GRM033R71E151KA01D		
220pF(221)	±10%(K)	GRM033R71E221KA01D		
330pF(331)	±10%(K)	GRM033R71E331KA01D		
470pF(471)	±10%(K)	GRM033R71E471KA01D		
680pF(681)	±10%(K)	GRM033R71E681KA01D		
1000pF(102)	±10%(K)	GRM033R71E102KA01D		
1500pF(152)	±10%(K)	GRM033R71E152KA01D		
2200pF(222)	±10%(K)		GRM033R71C222KA88D	
3300pF(332)	±10%(K)		GRM033R71C332KA88D	
4700pF(472)	±10%(K)			GRM033R71A472KA01D
6800pF(682)	±10%(K)			GRM033R71A682KA01D
10000pF(103)	±10%(K)			GRM033R71A103KA01D

The part number code is shown in () and Unit is shown in []. <->: EIA [inch] Code

(Part Number) **GR** **M** **02** **2** **R7** **1A** **680** **K** **A01** **L**
 ① ② ③ ④ ⑤ ⑥ ⑦ ⑧ ⑨ ⑩

① Product ID ② Series
 ⑤ Temperature Characteristics
 ⑥ Capacitance Tolerance

③ Dimension (LxW)
 ⑥ Rated Voltage
 ⑨ Individual Specification Code

④ Dimension (T)
 ⑦ Capacitance
 ⑩ Packaging*

Packaging Code in Part Number is a code shows STD 180mm Reel Taping.

*GRM022: D is applicable.

High Dielectric Constant Type X7R(R7) Characteristics

LxW [mm]		1.0x0.5(15)<0402>			
Rated Volt. [Vdc]		100(2A)	50(1H)	25(1E)	16(1C)
Capacitance	Tolerance	Part Number			
220pF(221)	±10%(K)	GRM155R72A221KA01D	GRM155R71H221KA01D		
330pF(331)	±10%(K)	GRM155R72A331KA01D	GRM155R71H331KA01D		
470pF(471)	±10%(K)	GRM155R72A471KA01D	GRM155R71H471KA01D		
680pF(681)	±10%(K)	GRM155R72A681KA01D	GRM155R71H681KA01D		
1000pF(102)	±10%(K)	GRM155R72A102KA01D	GRM155R71H102KA01D		
1500pF(152)	±10%(K)	GRM155R72A152KA01D	GRM155R71H152KA01D		
2200pF(222)	±10%(K)	GRM155R72A222KA01D	GRM155R71H222KA01D		
3300pF(332)	±10%(K)	GRM155R72A332KA01D	GRM155R71H332KA01D		
4700pF(472)	±10%(K)	GRM155R72A472KA01D	GRM155R71H472KA01D	GRM155R71E472KA01D	
6800pF(682)	±10%(K)		GRM155R71H682KA88D	GRM155R71E682KA01D	
10000pF(103)	±10%(K)		GRM155R71H103KA88D	GRM155R71E103KA01D	
15000pF(153)	±10%(K)		GRM155R71H153KA12D	GRM155R71E153KA61D	GRM155R71C153KA01D
22000pF(223)	±10%(K)		GRM155R71H223KA12D	GRM155R71E223KA61D	GRM155R71C223KA01D
33000pF(333)	±10%(K)			GRM155R71E333KA88D	GRM155R71C333KA01D
47000pF(473)	±10%(K)			GRM155R71E473KA88D	GRM155R71C473KA01D
68000pF(683)	±10%(K)				GRM155R71C683KA88D
0.10μF(104)	±10%(K)				GRM155R71C104KA88D

LxW [mm]		1.0x0.5(15)<0402>
Rated Volt. [Vdc]		10(1A)
Capacitance	Tolerance	Part Number
68000pF(683)	±10%(K)	GRM155R71A683KA01D
0.10μF(104)	±10%(K)	GRM155R71A104KA01D

The part number code is shown in () and Unit is shown in []. < >: EIA [inch] Code

1

High Dielectric Constant Type X7R(R7)/X7S(C7) Characteristics

LxW [mm]		1.6x0.8(18)<0603>			
Rated Volt. [Vdc]		100(2A)	50(1H)	25(1E)	16(1C)
Capacitance	Tolerance	Part Number			
220pF(221)	±10%(K)	GRM188R72A221KA01D	GRM188R71H221KA01D		
330pF(331)	±10%(K)	GRM188R72A331KA01D	GRM188R71H331KA01D		
470pF(471)	±10%(K)	GRM188R72A471KA01D	GRM188R71H471KA01D		
680pF(681)	±10%(K)	GRM188R72A681KA01D	GRM188R71H681KA01D		
1000pF(102)	±10%(K)	GRM188R72A102KA01D	GRM188R71H102KA01D		
1500pF(152)	±10%(K)	GRM188R72A152KA01D	GRM188R71H152KA01D		
2200pF(222)	±10%(K)	GRM188R72A222KA01D	GRM188R71H222KA01D		
3300pF(332)	±10%(K)	GRM188R72A332KA01D	GRM188R71H332KA01D		
4700pF(472)	±10%(K)	GRM188R72A472KA01D	GRM188R71H472KA01D		
6800pF(682)	±10%(K)	GRM188R72A682KA01D	GRM188R71H682KA01D		
10000pF(103)	±10%(K)	GRM188R72A103KA01D	GRM188R71H103KA01D	GRM188R71E103KA01D	
15000pF(153)	±10%(K)		GRM188R71H153KA01D	GRM188R71E153KA01D	
22000pF(223)	±10%(K)		GRM188R71H223KA01D	GRM188R71E223KA01D	
33000pF(333)	±10%(K)		GRM188R71H333KA61D	GRM188R71E333KA01D	
47000pF(473)	±10%(K)		GRM188R71H473KA61D	GRM188R71E473KA01D	
68000pF(683)	±10%(K)		GRM188R71H683KA93D	GRM188R71E683KA01D	
0.10μF(104)	±10%(K)	GRM188R72A104KA35D	GRM188R71H104KA93D	GRM188R71E104KA01D	
0.15μF(154)	±10%(K)			GRM188R71E154KA01D	GRM188R71C154KA01D
0.22μF(224)	±10%(K)			GRM188R71E224KA88D	GRM188R71C224KA01D
0.33μF(334)	±10%(K)				GRM188R71C334KA01D
0.47μF(474)	±10%(K)			GRM188R71E474KA12D*	GRM188R71C474KA88D
1.0μF(105)	±10%(K)			GRM188R71E105KA12D*	GRM188R71C105KA12D*

LxW [mm]		1.6x0.8(18)<0603>		
Rated Volt. [Vdc]		10(1A)	6.3(0J)	4(0G)
Capacitance	Tolerance	Part Number		
0.33μF(334)	±10%(K)	GRM188R71A334KA61D		
0.47μF(474)	±10%(K)	GRM188R71A474KA61D		
0.68μF(684)	±10%(K)	GRM188R71A684KA61D		
1.0μF(105)	±10%(K)	GRM188R71A105KA61D*		
2.2μF(225)	±10%(K)	GRM188R71A225KE15D*	GRM188C70J225KE20D*	GRM188C70G225KE20D*

The part number code is shown in () and Unit is shown in []. < >: EIA [inch] Code

*: Please refer to GRM Series Specifications and Test Method(2).

(Part Number) **GR** **M** **18** **8** **R7** **2A** **221** **K** **A01** **D**
 ① ② ③ ④ ⑤ ⑥ ⑦ ⑧ ⑨ ⑩

① Product ID ② Series
 ⑤ Temperature Characteristics
 ⑥ Capacitance Tolerance

③ Dimension (LxW)
 ⑥ Rated Voltage
 ⑨ Individual Specification Code

④ Dimension (T)
 ⑦ Capacitance
 ⑩ Packaging

Packaging Code in Part Number is a code shows STD 180mm Reel Taping.

High Dielectric Constant Type X7R(R7)/X7U(E7) Characteristics

LxW [mm]		2.0x1.25(21)<0805>			
Rated Volt. [Vdc]		100(2A)	50(1H)	25(1E)	16(1C)
Capacitance	Tolerance	Part Number			
6800pF(682)	±10%(K)	GRM219R72A682KA01D			
10000pF(103)	±10%(K)	GRM21BR72A103KA01L			
15000pF(153)	±10%(K)	GRM21BR72A153KA01L			
22000pF(223)	±10%(K)	GRM21BR72A223KA01L			
33000pF(333)	±10%(K)	GRM21BR72A333KA01L	GRM219R71H333KA01D		
47000pF(473)	±10%(K)	GRM21BR72A473KA01L	GRM21BR71H473KA01L		
68000pF(683)	±10%(K)		GRM21BR71H683KA01L	GRM219R71E683KA01D	
0.10μF(104)	±10%(K)		GRM21BR71H104KA01L	GRM21BR71E104KA01L	
0.15μF(154)	±10%(K)		GRM21BR71H154KA01L	GRM21BR71E154KA01L	
0.22μF(224)	±10%(K)	GRM21AR72A224KAC5L	GRM21BR71H224KA01L	GRM21BR71E224KA01L	
0.33μF(334)	±10%(K)	GRM21AR72A334KAC5L	GRM219R71H334KA88D	GRM21BR71E334KA01L	
0.47μF(474)	±10%(K)	GRM21BR72A474KA73L	GRM21BR71H474KA88L	GRM219R71E474KA88D	
0.68μF(684)	±10%(K)			GRM219R71E684KA88D	GRM219R71C684KA01D
1.0μF(105)	±10%(K)		GRM21BR71H105KA12L	GRM21BR71E105KA99L	GRM21BR71C105KA01L
				GRM219R71E105KA88D	
2.2μF(225)	±10%(K)			GRM21BR71E225KA73L*	GRM21BR71C225KA12L
4.7μF(475)	±10%(K)				GRM21BR71C475KA73L*

LxW [mm]		2.0x1.25(21)<0805>		
Rated Volt. [Vdc]		10(1A)	6.3(0J)	4(0G)
Capacitance	Tolerance	Part Number		
2.2μF(225)	±10%(K)	GRM21BR71A225KA01L		
4.7μF(475)	±10%(K)	GRM21BR71A475KA73L*		
10μF(106)	±10%(K)	GRM21BR71A106KE51L*	GRM21BR70J106KE76L*	
22μF(226)	±20%(M)			GRM21BE70G226ME51L*

The part number code is shown in () and Unit is shown in []. < >: EIA [inch] Code

*: Please refer to GRM Series Specifications and Test Method(2).

1

High Dielectric Constant Type X7R(R7)/X7U(E7) Characteristics

LxW [mm]		3.2x1.6(31)<1206>			
Rated Volt. [Vdc]		100(2A)	50(1H)	25(1E)	16(1C)
Capacitance	Tolerance	Part Number			
15000pF(153)	±10%(K)	GRM319R72A153KA01L			
22000pF(223)	±10%(K)	GRM31MR72A223KA01L			
33000pF(333)	±10%(K)	GRM31MR72A333KA01L			
47000pF(473)	±10%(K)	GRM31MR72A473KA01L			
68000pF(683)	±10%(K)	GRM31MR72A683KA01L			
0.10μF(104)	±10%(K)	GRM319R72A104KA01D			
0.15μF(154)	±10%(K)	GRM31MR72A154KA01L	GRM31MR71H154KA01L		
0.22μF(224)	±10%(K)	GRM31MR72A224KA01L	GRM31MR71H224KA01L		
0.33μF(334)	±10%(K)		GRM319R71H334KA01D		
0.47μF(474)	±10%(K)	GRM31MR72A474KA35L	GRM31MR71H474KA01L		
0.68μF(684)	±10%(K)	GRM31MR72A684KA35L	GRM31MR71H684KA88L		
1.0μF(105)	±10%(K)	GRM31CR72A105KA01L	GRM31MR71H105KA88L		
2.2μF(225)	±10%(K)		GRM31CR71H225KA88L	GRM31MR71E225KA93L	GRM31MR71C225KA35L
4.7μF(475)	±10%(K)		GRM31CR71H475KA12L	GRM31CR71E475KA88L	GRM31CR71C475KA01L
10μF(106)	±10%(K)			GRM31CR71E106KA12L*	GRM31CR71C106KAC7L*

LxW [mm]		3.2x1.6(31)<1206>		
Rated Volt. [Vdc]		10(1A)	6.3(0J)	4(0G)
Capacitance	Tolerance	Part Number		
10μF(106)	±10%(K)	GRM31CR71A106KA01L		
22μF(226)	±20%(M)	GRM31CR71A226ME15L*	GRM31CR70J226ME19L*	
47μF(476)	±20%(M)			GRM31CE70G476ME15L*

LxW [mm]		3.2x2.5(32)<1210>			
Rated Volt. [Vdc]		100(2A)	50(1H)	35(YA)	25(1E)
Capacitance	Tolerance	Part Number			
0.68μF(684)	±10%(K)	GRM32CR72A684KA01L	GRM32NR71H684KA01L		
1.0μF(105)	±10%(K)	GRM32CR72A105KA35L			
2.2μF(225)	±10%(K)	GRM32ER72A225KA35L			
4.7μF(475)	±10%(K)		GRM32ER71H475KA88L		
10μF(106)	±10%(K)			GRM32ER7YA106KA12L	GRM32DR71E106KA12L
22μF(226)	±20%(M)				GRM32ER71E226ME15L*

LxW [mm]		3.2x2.5(32)<1210>		
Rated Volt. [Vdc]		16(1C)	10(1A)	6.3(0J)
Capacitance	Tolerance	Part Number		
22μF(226)	±20%(M)	GRM32ER71C226ME18L*		
47μF(476)	±20%(M)		GRM32ER71A476ME15L*	GRM32ER70J476ME20L*

The part number code is shown in () and Unit is shown in []. < >: EIA [inch] Code

*: Please refer to GRM Series Specifications and Test Method(2).

(Part Number) **GR** **M** **31** **9** **R7** **2A** **153** **K** **A01** **L**
 ① ② ③ ④ ⑤ ⑥ ⑦ ⑧ ⑨ ⑩

① Product ID ② Series
 ⑤ Temperature Characteristics
 ⑥ Capacitance Tolerance

③ Dimension (LxW)
 ⑥ Rated Voltage
 ⑨ Individual Specification Code

④ Dimension (T)
 ⑦ Capacitance
 ⑩ Packaging

Packaging Code in Part Number is a code shows STD 180mm Reel Taping.

High Dielectric Constant Type X7R(R7)/X7T(D7) Characteristics Low Profile

LxW [mm]		1.0x0.5(15)<0402>		
Rated Volt. [Vdc]		50(1H)	25(1E)	16(1C)
Capacitance	Tolerance	Part Number		
220pF(221)	±10%(K)	GRM15XR71H221KA86D		
330pF(331)	±10%(K)	GRM15XR71H331KA86D		
470pF(471)	±10%(K)	GRM15XR71H471KA86D		
680pF(681)	±10%(K)	GRM15XR71H681KA86D		
1000pF(102)	±10%(K)	GRM15XR71H102KA86D		
1500pF(152)	±10%(K)	GRM15XR71H152KA86D		
2200pF(222)	±10%(K)		GRM15XR71E222KA86D	
3300pF(332)	±10%(K)			GRM15XR71C332KA86D
4700pF(472)	±10%(K)			GRM15XR71C472KA86D
6800pF(682)	±10%(K)			GRM15XR71C682KA86D
10000pF(103)	±10%(K)			GRM15XR71C103KA86D

LxW [mm]		1.6x0.8(18)<0603>
Rated Volt. [Vdc]		10(1A)
Capacitance	Tolerance	Part Number
1.0μF(105)	±10%(K)	GRM185D71A105KE36D*

LxW [mm]		2.0x1.25(21)<0805>			
Rated Volt. [Vdc]		100(2A)	50(1H)	25(1E)	16(1C)
Capacitance	Tolerance	Part Number			
6800pF(682)	±10%(K)	GRM219R72A682KA01D			
33000pF(333)	±10%(K)		GRM219R71H333KA01D		
68000pF(683)	±10%(K)			GRM219R71E683KA01D	
0.22μF(224)	±10%(K)	GRM21AR72A224KAC5L			
0.33μF(334)	±10%(K)	GRM21AR72A334KAC5L	GRM219R71H334KA88D		
0.47μF(474)	±10%(K)			GRM219R71E474KA88D	
0.68μF(684)	±10%(K)			GRM219R71E684KA88D	GRM219R71C684KA01D
1.0μF(105)	±10%(K)			GRM219R71E105KA88D	

The part number code is shown in () and Unit is shown in []. <>: EIA [inch] Code
 *: Please refer to GRM Series Specifications and Test Method(2).

LxW [mm]		3.2x1.6(31)<1206>			
Rated Volt. [Vdc]		100(2A)	50(1H)	25(1E)	16(1C)
Capacitance	Tolerance	Part Number			
15000pF(153)	±10%(K)	GRM319R72A153KA01L			
22000pF(223)	±10%(K)	GRM31MR72A223KA01L			
33000pF(333)	±10%(K)	GRM31MR72A333KA01L			
47000pF(473)	±10%(K)	GRM31MR72A473KA01L			
68000pF(683)	±10%(K)	GRM31MR72A683KA01L			
0.10μF(104)	±10%(K)	GRM319R72A104KA01D			
0.15μF(154)	±10%(K)	GRM31MR72A154KA01L	GRM31MR71H154KA01L		
0.22μF(224)	±10%(K)	GRM31MR72A224KA01L	GRM31MR71H224KA01L		
0.33μF(334)	±10%(K)		GRM319R71H334KA01D		
0.47μF(474)	±10%(K)	GRM31MR72A474KA35L	GRM31MR71H474KA01L		
0.68μF(684)	±10%(K)	GRM31MR72A684KA35L	GRM31MR71H684KA88L		
1.0μF(105)	±10%(K)		GRM31MR71H105KA88L		
2.2μF(225)	±10%(K)			GRM31MR71E225KA93L	GRM31MR71C225KA35L

LxW [mm]		3.2x2.5(32)<1210>	
Rated Volt. [Vdc]		100(2A)	50(1H)
Capacitance	Tolerance	Part Number	
0.68μF(684)	±10%(K)	GRM32CR72A684KA01L	GRM32NR71H684KA01L
1.0μF(105)	±10%(K)	GRM32CR72A105KA35L	

The part number code is shown in () and Unit is shown in []. <>: EIA [inch] Code

1

High Dielectric Constant Type X6S(C8) Characteristics

LxW [mm]		0.6x0.3(03)<0201>	
Rated Volt. [Vdc]		6.3(0J)	2.5(0E)
Capacitance	Tolerance	Part Number	
15000pF(153)	±10%(K)	GRM033C80J153KE01D*	
22000pF(223)	±10%(K)	GRM033C80J223KE01D*	
33000pF(333)	±10%(K)	GRM033C80J333KE01D*	
47000pF(473)	±10%(K)	GRM033C80J473KE19D*	
0.10μF(104)	±10%(K)	GRM033C80J104KE84D*	
0.22μF(224)	±10%(K)	GRM033C80E224ME15D*	

LxW [mm]		1.0x0.5(15)<0402>		
Rated Volt. [Vdc]		25(1E)	6.3(0J)	4(0G)
Capacitance	Tolerance	Part Number		
68000pF(683)	±10%(K)	GRM155C81E683KA12D		
0.10μF(104)	±10%(K)	GRM155C81E104KA12D		
0.15μF(154)	±10%(K)		GRM155C80J154KE01D*	GRM155C80G154KE01D*
0.22μF(224)	±10%(K)		GRM155C80J224KE01D*	GRM155C80G224KE01D*
0.33μF(334)	±10%(K)		GRM155C80J334KE01D*	GRM155C80G334KE01D*
0.47μF(474)	±10%(K)		GRM155C80J474KE19D*	GRM155C80G474KE01D*
0.68μF(684)	±10%(K)			GRM155C80G684KE19D*

LxW [mm]		1.6x0.8(18)<0603>			
Rated Volt. [Vdc]		10(1A)	6.3(0J)	4(0G)	2.5(0E)
Capacitance	Tolerance	Part Number			
1.0μF(105)	±10%(K)			GRM188C80G105MA01D	
2.2μF(225)	±10%(K)	GRM188C81A225KE34D*	GRM188C80J225KE19D*		
4.7μF(475)	±10%(K)			GRM188C80G475KE19D*	
10μF(106)	±20%(M)				GRM188C80E106ME47D*

LxW [mm]		2.0x1.25(21)<0805>			
Rated Volt. [Vdc]		25(1E)	16(1C)	10(1A)	6.3(0J)
Capacitance	Tolerance	Part Number			
1.0μF(105)	±10%(K)		GRM216C81C105KA12D*		
2.2μF(225)	±10%(K)		GRM219C81C225KA12D*		
4.7μF(475)	±10%(K)	GRM21BC81E475KA12L*	GRM21BC81C475KA88L*	GRM219C81A475KE34D*	GRM219C80J475KE19D*
10μF(106)	±10%(K)			GRM21BC81A106KE18L*	GRM21BC80J106KE19L*
					GRM219C80J106KE39D*

LxW [mm]		2.0x1.25(21)<0805>	
Rated Volt. [Vdc]		4(0G)	
Capacitance	Tolerance	Part Number	
10μF(106)	±10%(K)	GRM219C80G106KE19D*	
22μF(226)	±20%(M)	GRM21BC80G226ME39L*	

The part number code is shown in () and Unit is shown in []. <>: EIA [inch] Code
 *: Please refer to GRM Series Specifications and Test Method(2).

(Part Number) **GR M 03 3 C8 0J 153 K E01 D**
 ① ② ③ ④ ⑤ ⑥ ⑦ ⑧ ⑨ ⑩

① Product ID ② Series
 ⑤ Temperature Characteristics
 ⑥ Capacitance Tolerance

③ Dimension (LxW)
 ⑥ Rated Voltage
 ⑨ Individual Specification Code

④ Dimension (T)
 ⑦ Capacitance
 ⑩ Packaging

Packaging Code in Part Number is a code shows STD 180mm Reel Taping.

High Dielectric Constant Type X6S(C8)/X6T(D8) Characteristics

LxW [mm]		3.2x1.6(31)<1206>			
Rated Volt. [Vdc]		25(1E)	16(1C)	10(1A)	6.3(0J)
Capacitance	Tolerance	Part Number			
2.2μF(225)	±10%(K)		GRM316C81C225KA12D*		
4.7μF(475)	±10%(K)		GRM319C81C475KA12D*		
10μF(106)	±10%(K)	GRM31CC81E106KE15L*			
22μF(226)	±20%(M)			GRM31CC81A226ME19L*	GRM31CC80J226ME19L*
47μF(476)	±20%(M)				GRM31CC80J476ME18L*

LxW [mm]		3.2x1.6(31)<1206>	
Rated Volt. [Vdc]		4(0G)	
Capacitance	Tolerance	Part Number	
47μF(476)	±20%(M)	GRM31CC80G476ME19L*	
100μF(107)	±20%(M)	GRM31CD80G107ME39L*	

LxW [mm]		3.2x2.5(32)<1210>		
Rated Volt. [Vdc]		25(1E)	10(1A)	6.3(0J)
Capacitance	Tolerance	Part Number		
10μF(106)	±10%(K)	GRM32DC81E106KA12L		
22μF(226)	±20%(M)	GRM32EC81E226ME15L*		
47μF(476)	±20%(M)		GRM32EC81A476ME19L*	GRM32EC80J476ME64L*

The part number code is shown in () and Unit is shown in []. <->: EIA [inch] Code
 *: Please refer to GRM Series Specifications and Test Method(2).

High Dielectric Constant Type X6S(C8) Characteristics Low Profile

LxW [mm]		1.6x0.8(18)<0603>	
Rated Volt. [Vdc]		10(1A)	6.3(0J)
Capacitance	Tolerance	Part Number	
1.0μF(105)	±10%(K)	GRM185C81A105KE36D*	GRM185C80J105KE26D*

LxW [mm]		2.0x1.25(21)<0805>			
Rated Volt. [Vdc]		16(1C)	10(1A)	6.3(0J)	4(0G)
Capacitance	Tolerance	Part Number			
1.0μF(105)	±10%(K)	GRM216C81C105KA12D*			
2.2μF(225)	±10%(K)	GRM219C81C225KA12D*			
4.7μF(475)	±10%(K)		GRM219C81A475KE34D*	GRM219C80J475KE19D*	
10μF(106)	±10%(K)			GRM219C80J106KE39D*	GRM219C80G106KE19D*

LxW [mm]		3.2x1.6(31)<1206>	
Rated Volt. [Vdc]		16(1C)	
Capacitance	Tolerance	Part Number	
2.2μF(225)	±10%(K)	GRM316C81C225KA12D*	
4.7μF(475)	±10%(K)	GRM319C81C475KA12D*	

LxW [mm]		3.2x2.5(32)<1210>	
Rated Volt. [Vdc]		25(1E)	
Capacitance	Tolerance	Part Number	
10μF(106)	±10%(K)	GRM32DC81E106KA12L	

The part number code is shown in () and Unit is shown in []. <->: EIA [inch] Code
 *: Please refer to GRM Series Specifications and Test Method(2).

1

High Dielectric Constant Type X5R(R6) Characteristics

LxW [mm]		0.4x0.2(02)<01005>	
Rated Volt. [Vdc]		10(1A)	6.3(0J)
Capacitance	Tolerance	Part Number	
68pF(680)	±10%(K)	GRM022R61A680KA01L	
100pF(101)	±10%(K)	GRM022R61A101KA01L	
150pF(151)	±10%(K)	GRM022R61A151KA01L	
220pF(221)	±10%(K)	GRM022R61A221KA01L	
330pF(331)	±10%(K)	GRM022R61A331KA01L	
470pF(471)	±10%(K)	GRM022R61A471KA01L	
680pF(681)	±10%(K)	GRM022R60J681KE19L*	
1000pF(102)	±10%(K)	GRM022R60J102KE19L*	
1500pF(152)	±10%(K)	GRM022R60J152KE19L*	
2200pF(222)	±10%(K)	GRM022R60J222KE19L*	
3300pF(332)	±10%(K)	GRM022R60J332KE19L*	
4700pF(472)	±10%(K)	GRM022R60J472KE19L*	
6800pF(682)	±10%(K)	GRM022R60J682KE19L*	
10000pF(103)	±10%(K)	GRM022R60J103KE19L*	

LxW [mm]		0.6x0.3(03)<0201>			
Rated Volt. [Vdc]		25(1E)	16(1C)	10(1A)	6.3(0J)
Capacitance	Tolerance	Part Number			
100pF(101)	±10%(K)				
150pF(151)	±10%(K)				
220pF(221)	±10%(K)				
330pF(331)	±10%(K)				
470pF(471)	±10%(K)				
680pF(681)	±10%(K)				
1000pF(102)	±10%(K)				
1500pF(152)	±10%(K)				GRM033R61A152KA01D
2200pF(222)	±10%(K)				GRM033R61A222KA01D
3300pF(332)	±10%(K)				GRM033R61A332KA01D
4700pF(472)	±10%(K)				GRM033R61A472KA01D
6800pF(682)	±10%(K)				GRM033R61A682KA01D
10000pF(103)	±10%(K)				GRM033R61A103KA01D
15000pF(153)	±10%(K)				GRM033R60J153KE01D*
22000pF(223)	±10%(K)				GRM033R60J223KE01D*
33000pF(333)	±10%(K)				GRM033R60J333KE01D*
47000pF(473)	±10%(K)				GRM033R60J473KE19D*
0.10μF(104)	±10%(K)				GRM033R61A104KE84D*

The part number code is shown in () and Unit is shown in []. < >: EIA [inch] Code

[]: Please refer to X7R(R7) etc Characteristics.

*: Please refer to GRM Series Specifications and Test Method(2).

(Part Number) **GR** **M** **02** **2** **R6** **1A** **680** **K** **A01** **L**
 ① ② ③ ④ ⑤ ⑥ ⑦ ⑧ ⑨ ⑩

① Product ID ② Series
 ⑤ Temperature Characteristics
 ⑥ Capacitance Tolerance

③ Dimension (LxW)
 ⑥ Rated Voltage
 ⑨ Individual Specification Code

④ Dimension (T)
 ⑦ Capacitance
 ⑩ Packaging*

Packaging Code in Part Number is a code shows STD 180mm Reel Taping.

*GRM022: D is applicable.

High Dielectric Constant Type X5R(R6) Characteristics

LxW [mm]		1.0x0.5(15)<0402>			
Rated Volt. [Vdc]		100(2A)	50(1H)	25(1E)	16(1C)
Capacitance	Tolerance	Part Number			
220pF(221)	±10%(K)				
330pF(331)	±10%(K)				
470pF(471)	±10%(K)				
680pF(681)	±10%(K)				
1000pF(102)	±10%(K)		GRM155R61H102KA01D		
1500pF(152)	±10%(K)				
2200pF(222)	±10%(K)		GRM155R61H222KA01D		
3300pF(332)	±10%(K)				
4700pF(472)	±10%(K)		GRM155R61H472KA01D		
6800pF(682)	±10%(K)				
10000pF(103)	±10%(K)				
15000pF(153)	±10%(K)				
22000pF(223)	±10%(K)				GRM155R61C223KA01D
33000pF(333)	±10%(K)				GRM155R61C333KA01D
47000pF(473)	±10%(K)				GRM155R61C473KA01D
68000pF(683)	±10%(K)			GRM155R61E683KA87D	GRM155R61C683KA88D
0.10μF(104)	±10%(K)			GRM155R61E104KA87D	GRM155R61C104KA88D

LxW [mm]		1.0x0.5(15)<0402>		
Rated Volt. [Vdc]		10(1A)	6.3(0J)	4(0G)
Capacitance	Tolerance	Part Number		
33000pF(333)	±10%(K)	GRM155R61A333KA01D		
47000pF(473)	±10%(K)	GRM155R61A473KA01D		
68000pF(683)	±10%(K)	GRM155R61A683KA01D		
0.10μF(104)	±10%(K)	GRM155R61A104KA01D		
0.15μF(154)	±10%(K)	GRM155R61A154KE19D*	GRM155R60J154KE01D*	
0.22μF(224)	±10%(K)	GRM155R61A224KE19D*	GRM155R60J224KE01D*	
0.33μF(334)	±10%(K)	GRM155R61A334KE15D*	GRM155R60J334KE01D*	
0.47μF(474)	±10%(K)	GRM155R61A474KE15D*	GRM155R60J474KE19D*	
0.68μF(684)	±10%(K)	GRM155R61A684KE15D*	GRM155R60J684KE19D*	
1.0μF(105)	±10%(K)	GRM155R61A105KE15D*		
4.7μF(475)	±20%(M)			GRM155R60G475ME87D*

The part number code is shown in () and Unit is shown in []. < >: EIA [inch] Code

[]: Please refer to X7R(R7) etc Characteristics.

*: Please refer to GRM Series Specifications and Test Method(2).

1

High Dielectric Constant Type X5R(R6) Characteristics

LxW [mm]		1.6x0.8(18)<0603>			
Rated Volt. [Vdc]		100(2A)	50(1H)	25(1E)	16(1C)
Capacitance	Tolerance	Part Number			
220pF(221)	±10%(K)				
330pF(331)	±10%(K)				
470pF(471)	±10%(K)				
680pF(681)	±10%(K)				
1000pF(102)	±10%(K)		GRM188R61H102KA01D		
1500pF(152)	±10%(K)				
2200pF(222)	±10%(K)		GRM188R61H222KA01D		
3300pF(332)	±10%(K)				
4700pF(472)	±10%(K)		GRM188R61H472KA01D		
6800pF(682)	±10%(K)				
10000pF(103)	±10%(K)		GRM188R61H103KA01D		
15000pF(153)	±10%(K)				
22000pF(223)	±10%(K)		GRM188R61H223KA01D		
33000pF(333)	±10%(K)				
47000pF(473)	±10%(K)				
68000pF(683)	±10%(K)				
0.10μF(104)	±10%(K)			GRM188R61E104KA01D	GRM188R61C104KA01D
0.15μF(154)	±10%(K)				
0.22μF(224)	±10%(K)			GRM188R61E224KA88D	GRM188R61C224KA88D
0.33μF(334)	±10%(K)				
0.47μF(474)	±10%(K)			GRM188R61E474KA12D*	GRM188R61C474KA93D*
1.0μF(105)	±10%(K)			GRM188R61E105KA12D*	GRM188R61C105KA93D*
2.2μF(225)	±10%(K)				GRM188R61C225KE15D*

LxW [mm]		1.6x0.8(18)<0603>		
Rated Volt. [Vdc]		10(1A)	6.3(0J)	4(0G)
Capacitance	Tolerance	Part Number		
0.15μF(154)	±10%(K)	GRM188R61A154KA01D		
0.22μF(224)	±10%(K)	GRM188R61A224KA01D		
0.33μF(334)	±10%(K)			
0.47μF(474)	±10%(K)	GRM188R61A474KA61D		
0.68μF(684)	±10%(K)			
2.2μF(225)	±10%(K)	GRM188R61A225KE34D*		
4.7μF(475)	±10%(K)		GRM188R60J475KE19D*	
10μF(106)	±20%(M)		GRM188R60J106ME47D*	GRM188R60G106ME47D*

The part number code is shown in () and Unit is shown in []. <->: EIA [inch] Code

[] : Please refer to X7R(R7) etc Characteristics.

*: Please refer to GRM Series Specifications and Test Method(2).

(Part Number) **GR M 18 8 R6 1H 102 K A01 D**
 ① ② ③ ④ ⑤ ⑥ ⑦ ⑧ ⑨ ⑩

① Product ID ② Series
 ⑤ Temperature Characteristics
 ⑥ Capacitance Tolerance

③ Dimension (LxW)
 ⑥ Rated Voltage
 ⑨ Individual Specification Code

④ Dimension (T)
 ⑦ Capacitance
 ⑩ Packaging

Packaging Code in Part Number is a code shows STD 180mm Reel Taping.

High Dielectric Constant Type X5R(R6) Characteristics

LxW [mm]		2.0x1.25(21)<0805>			
Rated Volt. [Vdc]		100(2A)	50(1H)	25(1E)	16(1C)
Capacitance	Tolerance	Part Number			
6800pF(682)	±10%(K)				
10000pF(103)	±10%(K)				
15000pF(153)	±10%(K)				
22000pF(223)	±10%(K)				
33000pF(333)	±10%(K)				
47000pF(473)	±10%(K)				
68000pF(683)	±10%(K)				
0.10μF(104)	±10%(K)				
0.15μF(154)	±10%(K)				
0.22μF(224)	±10%(K)				
0.33μF(334)	±10%(K)				GRM21BR61C334KA01L
0.47μF(474)	±10%(K)				GRM21BR61C474KA01L
0.68μF(684)	±10%(K)				
1.0μF(105)	±10%(K)			GRM216R61E105KA12D	GRM21BR61C105KA01L
2.2μF(225)	±10%(K)			GRM21BR61E225KA12L	GRM21BR61C225KA88L*
				GRM219R61E225KA12D*	GRM219R61C225KA88D*
4.7μF(475)	±10%(K)			GRM21BR61E475KA12L*	GRM21BR61C475KA88L*
					GRM219R61C475KE15D*
10μF(106)	±10%(K)				GRM21BR61C106KE15L*

LxW [mm]		2.0x1.25(21)<0805>		
Rated Volt. [Vdc]		10(1A)	6.3(0J)	4(0G)
Capacitance	Tolerance	Part Number		
2.2μF(225)	±10%(K)	GRM21BR61A225KA01L		
4.7μF(475)	±10%(K)	GRM219R61A475KE34D*		
10μF(106)	±10%(K)	GRM21BR61A106KE19L*	GRM219R60J106KE19D*	
		GRM219R61A106KE44D*		
22μF(226)	±20%(M)		GRM21BR60J226ME39L*	GRM219R60G226ME66D*

The part number code is shown in () and Unit is shown in []. <->: EIA [inch] Code

[] : Please refer to X7R(R7) etc Characteristics.

*: Please refer to GRM Series Specifications and Test Method(2).

1

High Dielectric Constant Type X5R(R6) Characteristics

LxW [mm]		3.2x1.6(31)<1206>			
Rated Volt. [Vdc]		100(2A)	50(1H)	25(1E)	16(1C)
Capacitance	Tolerance	Part Number			
15000pF(153)	±10%(K)				
22000pF(223)	±10%(K)				
33000pF(333)	±10%(K)				
47000pF(473)	±10%(K)				
68000pF(683)	±10%(K)				
0.10μF(104)	±10%(K)				
0.15μF(154)	±10%(K)				
0.22μF(224)	±10%(K)				
0.33μF(334)	±10%(K)				
0.47μF(474)	±10%(K)				
0.68μF(684)	±10%(K)				
1.0μF(105)	±10%(K)				
2.2μF(225)	±10%(K)		GRM31CR61H225KA88L	GRM316R61E225KA12D*	
4.7μF(475)	±10%(K)			GRM31CR61E475KA88L	GRM31CR61C475KA01L
				GRM319R61E475KA12D*	GRM319R61C475KA88D*
10μF(106)	±10%(K)			GRM31CR61E106KA12L*	GRM31CR61C106KA88L
					GRM319R61C106KE15D*
22μF(226)	±20%(M)				GRM31CR61C226ME15L*

LxW [mm]		3.2x1.6(31)<1206>		
Rated Volt. [Vdc]		10(1A)	6.3(0J)	4(0G)
Capacitance	Tolerance	Part Number		
10μF(106)	±10%(K)	GRM319R61A106KE19L*		
22μF(226)	±20%(M)	GRM31CR61A226ME19L*	GRM31CR60J226ME19L*	
47μF(476)	±20%(M)		GRM31CR60J476ME19L*	
100μF(107)	±20%(M)		GRM31CR60J107ME39L*	GRM31CR60G107ME39L*

LxW [mm]		3.2x2.5(32)<1210>			
Rated Volt. [Vdc]		100(2A)	50(1H)	35(YA)	25(1E)
Capacitance	Tolerance	Part Number			
0.68μF(684)	±10%(K)				
1.0μF(105)	±10%(K)				
2.2μF(225)	±10%(K)				
4.7μF(475)	±10%(K)				
10μF(106)	±10%(K)			GRM32ER6YA106KA12L	GRM32DR61E106KA12L
22μF(226)	±20%(M)				GRM32ER61E226ME15L*

LxW [mm]		3.2x2.5(32)<1210>		
Rated Volt. [Vdc]		16(1C)	10(1A)	6.3(0J)
Capacitance	Tolerance	Part Number		
22μF(226)	±20%(M)			
47μF(476)	±20%(M)	GRM32ER61C476ME15L*	GRM32ER61A476ME20L*	

The part number code is shown in () and Unit is shown in []. < >: EIA [inch] Code

[]: Please refer to X7R(R7) etc Characteristics.

*: Please refer to GRM Series Specifications and Test Method(2).

(Part Number) **GR M 31 C R6 1H 225 K A88 L** ①Product ID ②Series ③Dimension (LxW) ④Dimension (T)
 ⑤Temperature Characteristics ⑥Rated Voltage ⑦Capacitance
 ⑧Capacitance Tolerance ⑨Individual Specification Code ⑩Packaging

Packaging Code in Part Number is a code shows STD 180mm Reel Taping.

High Dielectric Constant Type X5R(R6) Characteristics Low Profile

LxW [mm]		1.0x0.5(15)<0402>		
Rated Volt. [Vdc]		16(1C)	25(1E)	16(1C)
Capacitance	Tolerance	Part Number		
220pF(221)	±10%(K)			
330pF(331)	±10%(K)			
470pF(471)	±10%(K)			
680pF(681)	±10%(K)			
1000pF(102)	±10%(K)			
1500pF(152)	±10%(K)			
2200pF(222)	±10%(K)			
3300pF(332)	±10%(K)			
4700pF(472)	±10%(K)			
6800pF(682)	±10%(K)			
10000pF(103)	±10%(K)			

LxW [mm]		1.6x0.8(18)<0603>	
Rated Volt. [Vdc]		16(1C)	10(1A)
Capacitance	Tolerance	Part Number	
1.0μF(105)	±10%(K)	GRM185R61C105KE44D*	GRM185R61A105KE36D*

LxW [mm]		2.0x1.25(21)<0805>			
Rated Volt. [Vdc]		100(2A)	50(1H)	25(1E)	16(1C)
Capacitance	Tolerance	Part Number			
6800pF(682)	±10%(K)				
33000pF(333)	±10%(K)				
68000pF(683)	±10%(K)				
0.22μF(224)	±10%(K)				
0.33μF(334)	±10%(K)				
0.47μF(474)	±10%(K)				
0.68μF(684)	±10%(K)				
1.0μF(105)	±10%(K)			GRM216R61E105KA12D	
2.2μF(225)	±10%(K)			GRM219R61E225KA12D*	GRM219R61C225KA88D*
4.7μF(475)	±10%(K)				GRM219R61C475KE15D*

LxW [mm]		2.0x1.25(21)<0805>		
Rated Volt. [Vdc]		10(1A)	6.3(0J)	4(0G)
Capacitance	Tolerance	Part Number		
4.7μF(475)	±10%(K)	GRM219R61A475KE34D*		
10μF(106)	±10%(K)	GRM219R61A106KE44D*	GRM219R60J106KE19D*	
22μF(226)	±20%(M)			GRM219R60G226ME66D*

The part number code is shown in () and Unit is shown in []. < >: EIA [inch] Code

[] : Please refer to X7R(R7) etc Characteristics.

*: Please refer to GRM Series Specifications and Test Method(2).

1

High Dielectric Constant Type X5R(R6) Characteristics Low Profile

LxW [mm]		3.2x1.6(31)<1206>			
Rated Volt. [Vdc]		100(2A)	50(1H)	25(1E)	16(1C)
Capacitance	Tolerance	Part Number			
15000pF(153)	±10%(K)				
22000pF(223)	±10%(K)				
33000pF(333)	±10%(K)				
47000pF(473)	±10%(K)				
68000pF(683)	±10%(K)				
0.10μF(104)	±10%(K)				
0.15μF(154)	±10%(K)				
0.22μF(224)	±10%(K)				
0.33μF(334)	±10%(K)				
0.47μF(474)	±10%(K)				
0.68μF(684)	±10%(K)				
1.0μF(105)	±10%(K)				
2.2μF(225)	±10%(K)			GRM316R61E225KA12D*	
4.7μF(475)	±10%(K)			GRM319R61E475KA12D*	GRM319R61C475KA88D*
10μF(106)	±10%(K)				GRM319R61C106KE15D*

LxW [mm]		3.2x1.6(31)<1206>
Rated Volt. [Vdc]		10(1A)
Capacitance	Tolerance	Part Number
10μF(106)	±10%(K)	GRM319R61A106KE19D*

LxW [mm]		3.2x2.5(32)<1210>		
Rated Volt. [Vdc]		100(2A)	50(1H)	25(1E)
Capacitance	Tolerance	Part Number		
0.68μF(684)	±10%(K)			
1.0μF(105)	±10%(K)			
10μF(106)	±10%(K)			GRM32DR61E106KA12L

The part number code is shown in () and Unit is shown in []. < >: EIA [inch] Code

[] : Please refer to X7R(R7) etc Characteristics.

*: Please refer to GRM Series Specifications and Test Method(2).

(Part Number) **GR** **M** **31** **6** **R6** **1E** **225** **K** **A12** **D**
 ① ② ③ ④ ⑤ ⑥ ⑦ ⑧ ⑨ ⑩

① Product ID ② Series
 ⑤ Temperature Characteristics
 ⑥ Capacitance Tolerance

③ Dimension (LxW)
 ⑥ Rated Voltage
 ⑨ Individual Specification Code

④ Dimension (T)
 ⑦ Capacitance
 ⑩ Packaging

Packaging Code in Part Number is a code shows STD 180mm Reel Taping.

GRM Series Specifications and Test Methods (1) (Note1) Typical Inspection

1

(Note1) This Specifications and Test Methods indicates typical inspection. Please refer to individual specifications (our product specifications or the approval sheet).
 In case Non "*" is added in PNs table, please refer to GRM Series Specifications and Test Methods (1).
 In case "*" is added in PNs table, please refer to GRM Series Specifications and Test Methods (2).

No.	Item	Specifications		Test Method																				
		Temperature Compensating Type	High Dielectric Type																					
1	Operating Temperature Range	-55 to +125°C (2P/R/S/T, 3P/R/S/T/U, 4P/R/S/T/U: -25 to +85°C)	B1, B3, F1: -25 to +85°C R1, R7: -55 to +125°C R6: -55 to +85°C C8: -55 to +105°C E4: +10 to +85°C F5: -30 to +85°C	Reference temperature: 25°C (2Δ, 3Δ, 4Δ, B1, B3, F1, R1: 20°C)																				
2	Rated Voltage	See the previous pages.		The rated voltage is defined as the maximum voltage which may be applied continuously to the capacitor. When AC voltage is superimposed on DC voltage, V ^{P-P} or V ^{O-P} , whichever is larger, should be maintained within the rated voltage range.																				
3	Appearance	No defects or abnormalities		Visual inspection																				
4	Dimensions	Within the specified dimensions		Using calipers (GRM02 size is based on Microscope)																				
5	Dielectric Strength	No defects or abnormalities		No failure should be observed when 300%* of the rated voltage (temperature compensating type) or 250% of the rated voltage (high dielectric constant type) is applied between the terminations for 1 to 5 seconds, provided the charge/discharge current is less than 50mA. *200% for 500V																				
6	Insulation Resistance	C≤0.047μF: More than 10,000MΩ C>0.047μF: More than 500Ω · F C: Nominal Capacitance		The insulation resistance should be measured with a DC voltage not exceeding the rated voltage at 20/25°C and 75%RH max. and within 2 minutes of charging, provided the charge/discharge current is less than 50mA.																				
7	Capacitance	Within the specified tolerance		The capacitance/Q/D.F. should be measured at 20/25°C at the frequency and voltage shown in the table.																				
8	Q/ Dissipation Factor (D.F.)	30pF and over: Q≥1000 30pF and below: Q≥400+20C C: Nominal Capacitance (pF)	[R6, R7, C8] W.V.: 100V : 0.025 max. (C<0.068μF) : 0.05 max. (C≥0.068μF) W.V.: 50/35/25V: : 0.025 max.* *GRM32D R7/R6/C8 1E106: 0.035 max. W.V.: 16/10V: 0.035 max. W.V.: 6.3/4V : 0.05 max. (C<3.3μF) : 0.1 max. (C≥3.3μF) [E4] W.V.: 25Vmin: 0.025 max. [F1, F5] W.V.: 25V min. : 0.05 max. (C<0.1μF) : 0.09 max. (C≥0.1μF) W.V.: 16/10V: 0.125 max. W.V.: 6.3V: 0.15 max.		<table border="1"> <thead> <tr> <th>Char.</th> <th>ΔC to 7U, 1X (1000pF and below)</th> <th>ΔC to 7U, 1X (more than 1000pF) R6, R7, C8, F5, B1, B3, F1</th> <th>R6, R7, F5 (C>10μF)</th> <th>E4</th> </tr> </thead> <tbody> <tr> <td>Item</td> <td></td> <td></td> <td></td> <td></td> </tr> <tr> <td>Frequency</td> <td>1±0.1MHz</td> <td>1±0.1kHz</td> <td>120±24kHz</td> <td>1±0.1kHz</td> </tr> <tr> <td>Voltage</td> <td>0.5 to 5Vrms</td> <td>1±0.2Vrms</td> <td>0.5±0.1Vrms</td> <td>0.5±0.05Vrms</td> </tr> </tbody> </table>	Char.	ΔC to 7U, 1X (1000pF and below)	ΔC to 7U, 1X (more than 1000pF) R6, R7, C8, F5, B1, B3, F1	R6, R7, F5 (C>10μF)	E4	Item					Frequency	1±0.1MHz	1±0.1kHz	120±24kHz	1±0.1kHz	Voltage	0.5 to 5Vrms	1±0.2Vrms	0.5±0.1Vrms
Char.	ΔC to 7U, 1X (1000pF and below)	ΔC to 7U, 1X (more than 1000pF) R6, R7, C8, F5, B1, B3, F1	R6, R7, F5 (C>10μF)	E4																				
Item																								
Frequency	1±0.1MHz	1±0.1kHz	120±24kHz	1±0.1kHz																				
Voltage	0.5 to 5Vrms	1±0.2Vrms	0.5±0.1Vrms	0.5±0.05Vrms																				

Continued on the following page. ↗

1

GRM Series Specifications and Test Methods (1) (Note1) Typical Inspection

(Note1) This Specifications and Test Methods indicates typical inspection.

Please refer to individual specifications (our product specifications or the approval sheet).

In case Non "*" is added in PNs table, please refer to GRM Series Specifications and Test Methods (1).

In case "*" is added in PNs table, please refer to GRM Series Specifications and Test Methods (2).

Continued from the preceding page.

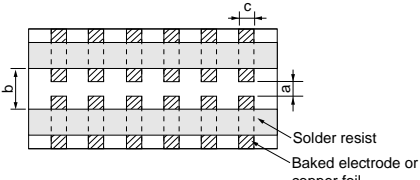
No.	Item	Specifications		Test Method																																						
		Temperature Compensating Type	High Dielectric Type																																							
9	Capacitance Temperature Characteristics	No bias	B1, B3: Within $\pm 10\%$ (-25 to +85°C) R1, R7: Within $\pm 15\%$ (-55 to +125°C) R6: Within $\pm 15\%$ (-55 to +85°C) E4: Within +22/-56% (+10 to +85°C) F1: Within +30/-80% (-25 to +85°C) F5: Within +22/-82% (-30 to +85°C) C8: Within $\pm 22\%$ (-55 to +105°C)	The capacitance change should be measured after 5 min. at each specified temp. stage. (1) Temperature Compensating Type The temperature coefficient is determined using the capacitance measured in step 3 as a reference. When cycling the temperature sequentially from step 1 through 5 (5C: +25 to +125°C/ Δ C: +20 to +125°C: other temp. coeffs.: +25 to +85°C/+20 to +85°C) the capacitance should be within the specified tolerance for the temperature coefficient and capacitance change as Table A-1. The capacitance drift is calculated by dividing the differences between the maximum and minimum measured values in the step 1, 3 and 5 by the cap. value in step 3.																																						
		50% of the Rated Voltage	B1: Within +10/-30% R1: Within +15/-40% F1: Within +30/-95%																																							
	Capacitance Drift	Within $\pm 0.2\%$ or $\pm 0.05\text{pF}$ (Whichever is larger.) *Do not apply to 1X/25V	*Initial measurement for high dielectric constant type Perform a heat treatment at 150+0/-10°C for one hour and then set for 24 \pm 2 hours at room temperature. Perform the initial measurement.	(2) High Dielectric Constant Type The ranges of capacitance change compared with the Reference Temperature value over the temperature ranges shown in the table should be within the specified ranges.* In case of applying voltage, the capacitance change should be measured after 1 more min. with applying voltage in equilibration of each temp. stage.																																						
10	Adhesive Strength of Termination	No removal of the terminations or other defect should occur.		Solder the capacitor to the test jig (glass epoxy board) shown in Fig. 1a using an eutectic solder. Then apply 10N* force in parallel with the test jig for 10 \pm 1 sec. The soldering should be done either with an iron or using the reflow method and should be conducted with care so that the soldering is uniform and free of defects such as heat shock. *1N (GRM02), 2N (GRM03), 5N (GRM15, GRM18)																																						
		 <p>Fig. 1a</p>			<table border="1"> <thead> <tr> <th>Type</th> <th>a</th> <th>b</th> <th>c</th> </tr> </thead> <tbody> <tr> <td>GRM02</td> <td>0.2</td> <td>0.56</td> <td>0.23</td> </tr> <tr> <td>GRM03</td> <td>0.3</td> <td>0.9</td> <td>0.3</td> </tr> <tr> <td>GRM15</td> <td>0.4</td> <td>1.5</td> <td>0.5</td> </tr> <tr> <td>GRM18</td> <td>1.0</td> <td>3.0</td> <td>1.2</td> </tr> <tr> <td>GRM21</td> <td>1.2</td> <td>4.0</td> <td>1.65</td> </tr> <tr> <td>GRM31</td> <td>2.2</td> <td>5.0</td> <td>2.0</td> </tr> <tr> <td>GRM32</td> <td>2.2</td> <td>5.0</td> <td>2.9</td> </tr> <tr> <td>GRM43</td> <td>3.5</td> <td>7.0</td> <td>3.7</td> </tr> <tr> <td>GRM55</td> <td>4.5</td> <td>8.0</td> <td>5.6</td> </tr> </tbody> </table>	Type	a	b	c	GRM02	0.2	0.56	0.23	GRM03	0.3	0.9	0.3	GRM15	0.4	1.5	0.5	GRM18	1.0	3.0	1.2	GRM21	1.2	4.0	1.65	GRM31	2.2	5.0	2.0	GRM32	2.2	5.0	2.9	GRM43	3.5	7.0	3.7	GRM55
Type	a	b	c																																							
GRM02	0.2	0.56	0.23																																							
GRM03	0.3	0.9	0.3																																							
GRM15	0.4	1.5	0.5																																							
GRM18	1.0	3.0	1.2																																							
GRM21	1.2	4.0	1.65																																							
GRM31	2.2	5.0	2.0																																							
GRM32	2.2	5.0	2.9																																							
GRM43	3.5	7.0	3.7																																							
GRM55	4.5	8.0	5.6																																							

Continued on the following page. ↗

GRM Series Specifications and Test Methods (1) (Note1) Typical Inspection

1

(Note1) This Specifications and Test Methods indicates typical inspection.

Please refer to individual specifications (our product specifications or the approval sheet).

In case Non "*" is added in PNs table, please refer to GRM Series Specifications and Test Methods (1).

In case "*" is added in PNs table, please refer to GRM Series Specifications and Test Methods (2).

Continued from the preceding page.

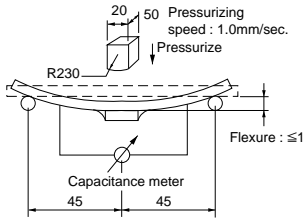
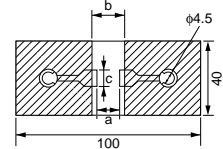
No.	Item	Specifications		Test Method																																				
		Temperature Compensating Type	High Dielectric Type																																					
11	Appearance	No defects or abnormalities		Solder the capacitor on the test jig (glass epoxy board) in the same manner and under the same conditions as (10). The capacitor should be subjected to a simple harmonic motion having a total amplitude of 1.5mm, the frequency being varied uniformly between the approximate limits of 10 and 55Hz. The frequency range, from 10 to 55Hz and return to 10Hz, should be traversed in approximately 1 minute. This motion should be applied for a period of 2 hours in each of 3 mutually perpendicular directions (total of 6 hours).																																				
	Capacitance	Within the specified tolerance																																						
11	Vibration Resistance	Q/D.F.	30pF and over: $Q \geq 1000$	[B1, B3, R6, R7, C8] W.V.: 100V : 0.025 max. (C<0.068μF) : 0.05 max. (C≥0.068μF) W.V.: 50/35/25V: : 0.025 max.* *GRM32D R7/R6/C8 1E106: 0.035 max. W.V.: 16/10V: 0.035 max.																																				
			30pF and below: $Q \geq 400+20C$	W.V.: 6.3/4V : 0.05 max. (C<3.3μF) : 0.1 max. (C≥3.3μF)																																				
12	Deflection	C: Nominal Capacitance (pF)	[E4] W.V.: 25Vmin: 0.025 max.	Solder the capacitor on the test jig (glass epoxy board) shown in Fig. 2a using an eutectic solder. Then apply a force in the direction shown in Fig. 3a for 5±1 sec. The soldering should be done by the reflow method and should be conducted with care so that the soldering is uniform and free of defects such as heat shock.																																				
			[F1, F5] W.V.: 25V min. : 0.05 max. (C<0.1μF) : 0.09 max. (C≥0.1μF) W.V.: 16/10V: 0.125 max. W.V.: 6.3V: 0.15 max.																																					
12	Appearance	No marking defects		Solder the capacitor on the test jig (glass epoxy board) shown in Fig. 2a using an eutectic solder. Then apply a force in the direction shown in Fig. 3a for 5±1 sec. The soldering should be done by the reflow method and should be conducted with care so that the soldering is uniform and free of defects such as heat shock.																																				
	Capacitance Change	Within ±5% or ±0.5pF (Whichever is larger)	Within ±10%																																					
12	Deflection	Capacitance meter	 <p>Fig. 3a</p>	 <p>Fig. 2a</p>																																				
			<table border="1"> <thead> <tr> <th>Type</th> <th>a</th> <th>b</th> <th>c</th> </tr> </thead> <tbody> <tr> <td>GRM02</td> <td>0.2</td> <td>0.56</td> <td>0.23</td> </tr> <tr> <td>GRM03</td> <td>0.3</td> <td>0.9</td> <td>0.3</td> </tr> <tr> <td>GRM15</td> <td>0.4</td> <td>1.5</td> <td>0.5</td> </tr> <tr> <td>GRM18</td> <td>1.0</td> <td>3.0</td> <td>1.2</td> </tr> <tr> <td>GRM21</td> <td>1.2</td> <td>4.0</td> <td>1.65</td> </tr> <tr> <td>GRM31</td> <td>2.2</td> <td>5.0</td> <td>2.0</td> </tr> <tr> <td>GRM32</td> <td>2.2</td> <td>5.0</td> <td>2.9</td> </tr> <tr> <td>GRM43</td> <td>3.5</td> <td>7.0</td> <td>3.7</td> </tr> <tr> <td>GRM55</td> <td>4.5</td> <td>8.0</td> <td>5.6</td> </tr> </tbody> </table> <p>(in mm)</p>	Type	a	b	c	GRM02	0.2	0.56	0.23	GRM03	0.3	0.9	0.3	GRM15	0.4	1.5	0.5	GRM18	1.0	3.0	1.2	GRM21	1.2	4.0	1.65	GRM31	2.2	5.0	2.0	GRM32	2.2	5.0	2.9	GRM43	3.5	7.0	3.7	GRM55
Type	a	b	c																																					
GRM02	0.2	0.56	0.23																																					
GRM03	0.3	0.9	0.3																																					
GRM15	0.4	1.5	0.5																																					
GRM18	1.0	3.0	1.2																																					
GRM21	1.2	4.0	1.65																																					
GRM31	2.2	5.0	2.0																																					
GRM32	2.2	5.0	2.9																																					
GRM43	3.5	7.0	3.7																																					
GRM55	4.5	8.0	5.6																																					
13	Solderability of Termination	75% of the terminations are to be soldered evenly and continuously.		Immerse the capacitor in a solution of ethanol (JIS-K-8101) and rosin (JIS-K-5902) (25% rosin in weight proportion). Preheat at 80 to 120°C for 10 to 30 seconds. After preheating, immerse in an eutectic solder solution for 2±0.5 seconds at 230±5°C or Sn-3.0Ag-0.5Cu solder solution for 2±0.5 seconds at 245±5°C.																																				

Continued on the following page.

GRM Series Specifications and Test Methods (1) (Note1) Typical Inspection

(Note1) This Specifications and Test Methods indicates typical inspection. Please refer to individual specifications (our product specifications or the approval sheet).
 In case Non "*" is added in PNs table, please refer to GRM Series Specifications and Test Methods (1).
 In case "*" is added in PNs table, please refer to GRM Series Specifications and Test Methods (2).

Continued from the preceding page.

No.	Item	Specifications		Test Method	
		Temperature Compensating Type	High Dielectric Type		
14	Resistance to Soldering Heat	The measured and observed characteristics should satisfy the specifications in the following table.		Preheat the capacitor at 120 to 150°C for 1 minute. Immerse the capacitor in an eutectic solder or Sn-3.0Ag-0.5Cu solder solution at 270±5°C for 10±0.5 seconds. Set at room temperature for 24±2 hours, then measure. •Initial measurement for high dielectric constant type Perform a heat treatment at 150+0/-10°C for one hour and then set at room temperature for 24±2 hours. Perform the initial measurement. •Preheating for GRM32/43/55	
		Appearance	No defects or abnormalities		
		Capacitance Change	Within ±2.5% or ±0.25pF (Whichever is larger)		B1, B3, R1, R6, R7, C8 : Within ±7.5% F1, F5, E4: Within ±20%
		Q/D.F.	30pF and over: Q≥1000 30pF and below: Q≥400+20C C: Nominal Capacitance (pF)		[B1, B3, R6, R7, C8] W.V.: 100V : 0.025 max. (C<0.068μF) : 0.05 max. (C≥0.068μF) W.V.: 50/35/25V: : 0.025 max.* *GRM32D R7/R6/C8 1E106: 0.035 max. W.V.: 16/10V: 0.035 max. W.V.: 6.3/4V : 0.05 max. (C<3.3μF) : 0.1 max. (C≥3.3μF) [E4] W.V.: 25Vmin: 0.025 max. [F1, F5] W.V.: 25V min. : 0.05 max. (C<0.1μF) : 0.09 max. (C≥0.1μF) W.V.: 16/10V: 0.125 max. W.V.: 6.3V: 0.15 max.
		I.R.	More than 10,000MΩ or 500Ω · F (Whichever is smaller)		
		Dielectric Strength	No defects		
15	Temperature Cycle	The measured and observed characteristics should satisfy the specifications in the following table.		Fix the capacitor to the supporting jig in the same manner and under the same conditions as (10). Perform the five cycles according to the four heat treatments shown in the following table. Set for 24±2 hours at room temperature, then measure.	
		Appearance	No defects or abnormalities		
		Capacitance Change	Within ±2.5% or ±0.25pF (Whichever is larger)		B1, B3, R1, R6, R7, C8 : Within ±7.5% F1, F5, E4: Within ±20%
		Q/D.F.	30pF and over: Q≥1000 30pF and below: Q≥400+20C C: Nominal Capacitance (pF)		[B1, B3, R6, R7, C8] W.V.: 100V : 0.025 max. (C<0.068μF) : 0.05 max. (C≥0.068μF) W.V.: 50/35/25V: : 0.025 max.* *GRM32D R7/R6/C8 1E106: 0.035 max. W.V.: 16/10V: 0.035 max. W.V.: 6.3/4V : 0.05 max. (C<3.3μF) : 0.1 max. (C≥3.3μF) [E4] W.V.: 25Vmin: 0.05 max. [F1, F5] W.V.: 25V min. : 0.05 max. (C<0.1μF) : 0.09 max. (C≥0.1μF) W.V.: 16/10V: 0.125 max. W.V.: 6.3V: 0.15 max.
		I.R.	More than 10,000MΩ or 500Ω · F (Whichever is smaller)		
		Dielectric Strength	No defects		

Step	Temperature	Time
1	100 to 120°C	1 min.
2	170 to 200°C	1 min.

Step	1	2	3	4
Temp. (°C)	Min. Operating Temp. +0/-3	Room Temp.	Max. Operating Temp. +3/-0	Room Temp.
Time (min.)	30±3	2 to 3	30±3	2 to 3

Continued on the following page. ↗

GRM Series Specifications and Test Methods (1) (Note1) Typical Inspection

1

(Note1) This Specifications and Test Methods indicates typical inspection. Please refer to individual specifications (our product specifications or the approval sheet).
 In case Non "*" is added in PNs table, please refer to GRM Series Specifications and Test Methods (1).
 In case "*" is added in PNs table, please refer to GRM Series Specifications and Test Methods (2).

Continued from the preceding page.

No.	Item	Specifications		Test Method	
		Temperature Compensating Type	High Dielectric Type		
16	Humidity (Steady State)	The measured and observed characteristics should satisfy the specifications in the following table.		Set the capacitor at 40±2°C and in 90 to 95% humidity for 500±12 hours. Remove and set for 24±2 hours at room temperature, then measure.	
		Appearance	No defects or abnormalities		
		Capacitance Change	Within ±5% or ±0.5pF (Whichever is larger)		B1, B3, R1, R6, R7, C8 : Within ±12.5% F1, F5, E4: Within ±30%
		Q/D.F.	30pF and over: Q≥350 10pF and over 30pF and below: Q≥275+2.5C 10pF and below: Q≥200+10C C: Nominal Capacitance (pF)		[R6, R7, C8] W.V.: 100V : 0.05 max. (C<0.068μF) : 0.075 max. (C≥0.068μF) W.V.: 50/35/25/16/10V : 0.05 max. W.V.: 6.3/4V : 0.075 max. (C<3.3μF) : 0.125 max. (C≥3.3μF) [E4] W.V.: 25Vmin: 0.05 max. [F1, F5] W.V.: 25V min. : 0.075 max. (C<0.1μF) : 0.125 max. (C≥0.1μF) W.V.: 16/10V: 0.15 max. W.V.: 6.3V: 0.2 max.
		I.R.	More than 1,000MΩ or 50Ω · F (Whichever is smaller)		
17	Humidity Load	The measured and observed characteristics should satisfy the specifications in the following table.		Apply the rated voltage at 40±2°C and 90 to 95% humidity for 500±12 hours. Remove and set for 24±2 hours at room temperature, then measure. The charge/discharge current is less than 50mA. •Initial measurement for F1, F5/10V max. Apply the rated DC voltage for 1 hour at 40±2°C. Remove and set for 24±2 hours at room temperature. Perform initial measurement.	
		Appearance	No defects or abnormalities		
		Capacitance Change	Within ±7.5% or ±0.75pF (Whichever is larger)		B1, B3, R1, R6, R7, C8 : Within ±12.5% F1, F5, E4: Within ±30% [W.V.: 10V max.] F1, F5: Within +30/-40%
		Q/D.F.	30pF and over: Q≥200 30pF and below: Q≥100+10C/3 C: Nominal Capacitance (pF)		[B1, B3, R6, R7, C8] W.V.: 100V : 0.05 max. (C<0.068μF) : 0.075 max. (C≥0.068μF) W.V.: 50/35/25/16/10V : 0.05 max. W.V.: 6.3/4V : 0.075 max. (C<3.3μF) : 0.125 max. (C≥3.3μF) [E4] W.V.: 25Vmin: 0.05 max. [F1, F5] W.V.: 25V min. : 0.075 max. (C<0.1μF) : 0.125 max. (C≥0.1μF) W.V.: 16/10V: 0.15 max. W.V.: 6.3V: 0.2 max.
		I.R.	More than 500MΩ or 25Ω · F (Whichever is smaller)		

Continued on the following page. ↗

GRM Series Specifications and Test Methods (1) (Note1) Typical Inspection

(Note1) This Specifications and Test Methods indicates typical inspection. Please refer to individual specifications (our product specifications or the approval sheet).
 In case Non "*" is added in PNs table, please refer to GRM Series Specifications and Test Methods (1).
 In case "*" is added in PNs table, please refer to GRM Series Specifications and Test Methods (2).

Continued from the preceding page.

No.	Item	Specifications		Test Method	
		Temperature Compensating Type	High Dielectric Type		
18	High Temperature Load	The measured and observed characteristics should satisfy the specifications in the following table.		Apply 200%* of the rated voltage at the maximum operating temperature $\pm 3^{\circ}\text{C}$ for 1000 \pm 12 hours. Set for 24 \pm 2 hours at room temperature, then measure. The charge/discharge current is less than 50mA. *Initial measurement for high dielectric constant type. Apply 200% of the rated voltage* at the maximum operating temperature $\pm 3^{\circ}\text{C}$ for one hour. Remove and set for 24 \pm 2 hours at room temperature. Perform initial measurement. *GRM155C81E 683/104, GRM21BR71H105, GRM21BR72A474, GRM21BR71C225, GRM31CR71H475, GRM32E R6/R7 YA106, GRM32D R7/R6/C8 1E106: 150% of the rated voltage.	
		Appearance	No defects or abnormalities		
		Capacitance Change	Within $\pm 3\%$ or $\pm 0.3\text{pF}$ (Whichever is larger)		B1, B3, R1, R6, R7, C8 : Within $\pm 12.5\%$ F1, F5, E4: Within $\pm 30\%$ [Except 10V max. and. $C \geq 1.0\mu\text{F}$] F1, F5: Within $+30/-40\%$ [10V max. and $C \geq 1.0\mu\text{F}$]
		Q/D.F.	30pF and over: $Q \geq 350$ 10pF and over 30pF and below: $Q \geq 275+2.5C$ 10pF and below: $Q \geq 200+10C$ C: Nominal Capacitance (pF)		[B1, B3, R6, R7, C8] W.V.: 100V : 0.05 max. ($C < 0.068\mu\text{F}$) : 0.075 max. ($C \geq 0.068\mu\text{F}$) W.V.: 50/35/25/16/10V : 0.05 max. W.V.: 6.3/4V : 0.075 max. ($C < 3.3\mu\text{F}$) : 0.125 max. ($C \geq 3.3\mu\text{F}$) [E4] W.V.: 25Vmin: 0.05 max. [F1, F5] W.V.: 25V min. : 0.075 max. ($C < 0.1\mu\text{F}$) : 0.125 max. ($C \geq 0.1\mu\text{F}$) W.V.: 16/10V: 0.15 max. W.V.: 6.3V: 0.2 max.
I.R.	More than 1,000M Ω or 50 $\Omega \cdot \text{F}$ (Whichever is smaller)				

Table A-1 (1)

Char.	Nominal Values (ppm/ $^{\circ}\text{C}$)*1	Capacitance Change from 25 $^{\circ}\text{C}$ (%)					
		-55		-30		-10	
		Max.	Min.	Max.	Min.	Max.	Min.
5C	0 \pm 30	0.58	-0.24	0.40	-0.17	0.25	-0.11
6C	0 \pm 60	0.87	-0.48	0.59	-0.33	0.38	-0.21
6P	-150 \pm 60	2.33	0.72	1.61	0.50	1.02	0.32
6R	-220 \pm 60	3.02	1.28	2.08	0.88	1.32	0.56
6S	-330 \pm 60	4.09	2.16	2.81	1.49	1.79	0.95
6T	-470 \pm 60	5.46	3.28	3.75	2.26	2.39	1.44
7U	-750 \pm 120	8.78	5.04	6.04	3.47	3.84	2.21
1X	+350 to -1000	-	-	-	-	-	-

*1: Nominal values denote the temperature coefficient within a range of 25 $^{\circ}\text{C}$ to 125 $^{\circ}\text{C}$ (for ΔC)/85 $^{\circ}\text{C}$ (for other TC).

(2)

Char.	Nominal Values (ppm/ $^{\circ}\text{C}$)*2	Capacitance Change from 20 $^{\circ}\text{C}$ (%)					
		-55		-25		-10	
		Max.	Min.	Max.	Min.	Max.	Min.
2C	0 \pm 60	0.82	-0.45	0.49	-0.27	0.33	-0.18
3C	0 \pm 120	1.37	-0.90	0.82	-0.54	0.55	-0.36
4C	0 \pm 250	2.56	-1.88	1.54	-1.13	1.02	-0.75
2P	-150 \pm 60	-	-	1.32	0.41	0.88	0.27
3P	-150 \pm 120	-	-	1.65	0.14	1.10	0.09
4P	-150 \pm 250	-	-	2.36	-0.45	1.57	-0.30
2R	-220 \pm 60	-	-	1.70	0.72	1.13	0.48
3R	-220 \pm 120	-	-	2.03	0.45	1.35	0.30
4R	-220 \pm 250	-	-	2.74	-0.14	1.83	-0.09
2S	-330 \pm 60	-	-	2.30	1.22	1.54	0.81
3S	-330 \pm 120	-	-	2.63	0.95	1.76	0.63
4S	-330 \pm 250	-	-	3.35	0.36	2.23	0.24
2T	-470 \pm 60	-	-	3.07	1.85	2.05	1.23
3T	-470 \pm 120	-	-	3.40	1.58	2.27	1.05
4T	-470 \pm 250	-	-	4.12	0.99	2.74	0.66
3U	-750 \pm 120	-	-	4.94	2.84	3.29	1.89
4U	-750 \pm 250	-	-	5.65	2.25	3.77	1.50

*2: Nominal values denote the temperature coefficient within a range of 20 $^{\circ}\text{C}$ to 125 $^{\circ}\text{C}$ (for ΔC)/85 $^{\circ}\text{C}$ (for other TC).

GRM Series Specifications and Test Methods (2) (Note1) Typical Inspection

1

(Note1) This Specifications and Test Methods indicates typical inspection. Please refer to individual specifications (our product specifications or the approval sheet).
 In case Non "*" is added in PNs table, please refer to GRM Series Specifications and Test Methods (1).
 In case "*" is added in PNs table, please refer to GRM Series Specifications and Test Methods (2).

No.	Item	Specifications	Test Method																																																								
1	Operating Temperature Range	B1, B3, F1: -25 to +85°C R1, R7, C7, D7, E7: -55 to +125°C C6, R6: -55 to +85°C F5: -30 to +85°C C8, D8: -55 to +105°C,	Reference temperature: 25°C (B1, B3, R1, F1: 20°C)																																																								
2	Rated Voltage	See the previous pages.	The rated voltage is defined as the maximum voltage which may be applied continuously to the capacitor. When AC voltage is superimposed on DC voltage, V ^{P-P} or V ^{O-P} , whichever is larger, should be maintained within the rated voltage range.																																																								
3	Appearance	No defects or abnormalities	Visual inspection																																																								
4	Dimensions	Within the specified dimensions	Using calipers (GRM02 size is based on Microscope)																																																								
5	Dielectric Strength	No defects or abnormalities	No failure should be observed when 250% of the rated voltage is applied between the terminations for 1 to 5 seconds, provided the charge/discharge current is less than 50mA.																																																								
6	Insulation Resistance	More than 50Ω · F	The insulation resistance should be measured with a DC voltage not exceeding the rated voltage at reference temperature and 75%RH max. and within 1 minutes of charging, provided the charge/discharge current is less than 50mA.																																																								
7	Capacitance	Within the specified tolerance *Table 1 <table border="1"> <thead> <tr> <th>GRM155</th> <th>B3/R6</th> <th>1A</th> <th>124 to 105</th> </tr> </thead> <tbody> <tr> <td>GRM185</td> <td>B3/R6</td> <td>1C/1A</td> <td>105</td> </tr> <tr> <td>GRM185</td> <td>C8/D7</td> <td>1A</td> <td>105</td> </tr> <tr> <td>GRM188</td> <td>B3/R6</td> <td>1C/1A</td> <td>225</td> </tr> <tr> <td>GRM188</td> <td>R7/C8</td> <td>1A</td> <td>225</td> </tr> <tr> <td>GRM188</td> <td>B3/R6</td> <td>1A</td> <td>335</td> </tr> <tr> <td>GRM219</td> <td>B3/R6</td> <td>1C/1A</td> <td>475, 106</td> </tr> <tr> <td>GRM219</td> <td>C8</td> <td>1A</td> <td>475</td> </tr> <tr> <td>GRM21B</td> <td>B3/R6</td> <td>1C/1A</td> <td>106</td> </tr> <tr> <td>GRM21B</td> <td>R7/C8</td> <td>1A</td> <td>106</td> </tr> <tr> <td>GRM319</td> <td>B3/R6</td> <td>1C/1A</td> <td>106</td> </tr> </tbody> </table>	GRM155	B3/R6	1A	124 to 105	GRM185	B3/R6	1C/1A	105	GRM185	C8/D7	1A	105	GRM188	B3/R6	1C/1A	225	GRM188	R7/C8	1A	225	GRM188	B3/R6	1A	335	GRM219	B3/R6	1C/1A	475, 106	GRM219	C8	1A	475	GRM21B	B3/R6	1C/1A	106	GRM21B	R7/C8	1A	106	GRM319	B3/R6	1C/1A	106	The capacitance/D.F. should be measured at reference temperature at the measuring frequency and voltage shown in the table. <table border="1"> <thead> <tr> <th>Nominal Capacitance</th> <th>Measuring Frequency</th> <th>Measuring Voltage</th> </tr> </thead> <tbody> <tr> <td>C ≤ 10μF (10V min.)*</td> <td>1±0.1kHz</td> <td>1.0±0.2Vrms</td> </tr> <tr> <td>C ≤ 10μF (6.3V max.)</td> <td>1±0.1kHz</td> <td>0.5±0.1Vrms</td> </tr> <tr> <td>C > 10μF</td> <td>120±24Hz</td> <td>0.5±0.1Vrms</td> </tr> </tbody> </table> *For items in Table1	Nominal Capacitance	Measuring Frequency	Measuring Voltage	C ≤ 10μF (10V min.)*	1±0.1kHz	1.0±0.2Vrms	C ≤ 10μF (6.3V max.)	1±0.1kHz	0.5±0.1Vrms	C > 10μF	120±24Hz	0.5±0.1Vrms
GRM155	B3/R6	1A	124 to 105																																																								
GRM185	B3/R6	1C/1A	105																																																								
GRM185	C8/D7	1A	105																																																								
GRM188	B3/R6	1C/1A	225																																																								
GRM188	R7/C8	1A	225																																																								
GRM188	B3/R6	1A	335																																																								
GRM219	B3/R6	1C/1A	475, 106																																																								
GRM219	C8	1A	475																																																								
GRM21B	B3/R6	1C/1A	106																																																								
GRM21B	R7/C8	1A	106																																																								
GRM319	B3/R6	1C/1A	106																																																								
Nominal Capacitance	Measuring Frequency	Measuring Voltage																																																									
C ≤ 10μF (10V min.)*	1±0.1kHz	1.0±0.2Vrms																																																									
C ≤ 10μF (6.3V max.)	1±0.1kHz	0.5±0.1Vrms																																																									
C > 10μF	120±24Hz	0.5±0.1Vrms																																																									
8	Dissipation Factor (D.F.)	B1, B3, R1, R6*, R7*, C7, C8, E7, D7: 0.1 max. C6: 0.125 max. D8: 0.15 max. F1, F5: 0.2 max. *GRM31CR71E106: 0.125 max. GRM31CR6 0J/0G 107: 0.15 max.	GRM188C80E106: Perform a heat treatment at 150+0/-10°C for one hour and then set for 24±2 hours at room temperature.																																																								
9	Capacitance Temperature Characteristics	No bias	The capacitance change should be measured after 5 min. at each specified temp. stage. The ranges of capacitance change compared with the reference temperature value over the temperature ranges shown in the table should be within the specified ranges.* In case of applying voltage, the capacitance change should be measured after 1 more min. with applying voltage in equilibration of each temp. stage. *GRM32DR60J226, GRM43 B1/B3/R6 0J/1A 336/476 only: 1.0±0.2Vrms																																																								
		50% of the Rated Voltage																																																									

Step	Temperature (°C)	Applying Voltage (V)	
1	25±2 (for R6, R7, C6, C7, C8, D7, D8, E7, F5) 20±2 (for B1, B3, F1, R1)	No bias	
	-55±3 (for R1, R6, R7, C6, C7, C8, D7, D8, E7) -30±3 (for F5) -25±3 (for B1, B3, F1)		
3	25±2 (for R6, R7, C6, C7, C8, D7, D8, E7, F5) 20±2 (for B1, B3, F1, R1)		
	125±3 (for R1, R7, C7, D7, E7) 105±3 (for C8, D8) 85±3 (for B1, B3, F1, F5, R6, C6)		
5	20±2 (for B1, F1, R1)		
6	-55±3 (for R1) -25±3 (for B1, F1)		50% of the rated voltage
	20±2 (for B1, F1, R1)		
8	125±3 (for R1) 85±3 (for B1, F1)		

*Initial measurement for high dielectric constant type
 Perform a heat treatment at 150 +0/-10°C for one hour and then set for 24±2 hours at room temperature.
 Perform the initial measurement.

Continued on the following page.

GRM Series Specifications and Test Methods (2) (Note1) Typical Inspection

(Note1) This Specifications and Test Methods indicates typical inspection.

Please refer to individual specifications (our product specifications or the approval sheet).

In case Non "*" is added in PNs table, please refer to GRM Series Specifications and Test Methods (1).

In case "*" is added in PNs table, please refer to GRM Series Specifications and Test Methods (2).

Continued from the preceding page.

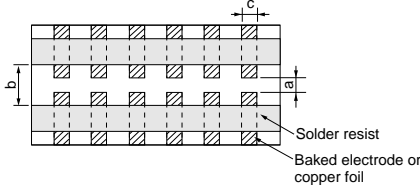
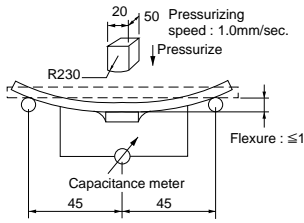
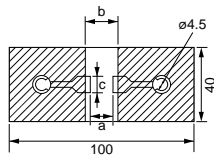
No.	Item	Specifications	Test Method																																								
10	Adhesive Strength of Termination	<p>No removal of the terminations or other defects should occur.</p>  <p>Fig. 1a</p>	<p>Solder the capacitor on the test jig (glass epoxy board) shown in Fig. 1a using an eutectic solder. Then apply 10N* force in parallel with the test jig for 10±1sec.</p> <p>The soldering should be done either with an iron or using the reflow method and should be conducted with care so that the soldering is uniform and free of defects such as heat shock.</p> <p>*1N: GRM02, 2N: GRM03, 5N: GRM15/GRM18</p> <table border="1"> <thead> <tr> <th>Type</th> <th>a</th> <th>b</th> <th>c</th> </tr> </thead> <tbody> <tr> <td>GRM02</td> <td>0.2</td> <td>0.56</td> <td>0.23</td> </tr> <tr> <td>GRM03</td> <td>0.3</td> <td>0.9</td> <td>0.3</td> </tr> <tr> <td>GRM15</td> <td>0.4</td> <td>1.5</td> <td>0.5</td> </tr> <tr> <td>GRM18</td> <td>1.0</td> <td>3.0</td> <td>1.2</td> </tr> <tr> <td>GRM21</td> <td>1.2</td> <td>4.0</td> <td>1.65</td> </tr> <tr> <td>GRM31</td> <td>2.2</td> <td>5.0</td> <td>2.0</td> </tr> <tr> <td>GRM32</td> <td>2.2</td> <td>5.0</td> <td>2.9</td> </tr> <tr> <td>GRM43</td> <td>3.5</td> <td>7.0</td> <td>3.7</td> </tr> <tr> <td>GRM55</td> <td>4.5</td> <td>8.0</td> <td>5.6</td> </tr> </tbody> </table>	Type	a	b	c	GRM02	0.2	0.56	0.23	GRM03	0.3	0.9	0.3	GRM15	0.4	1.5	0.5	GRM18	1.0	3.0	1.2	GRM21	1.2	4.0	1.65	GRM31	2.2	5.0	2.0	GRM32	2.2	5.0	2.9	GRM43	3.5	7.0	3.7	GRM55	4.5	8.0	5.6
Type	a	b	c																																								
GRM02	0.2	0.56	0.23																																								
GRM03	0.3	0.9	0.3																																								
GRM15	0.4	1.5	0.5																																								
GRM18	1.0	3.0	1.2																																								
GRM21	1.2	4.0	1.65																																								
GRM31	2.2	5.0	2.0																																								
GRM32	2.2	5.0	2.9																																								
GRM43	3.5	7.0	3.7																																								
GRM55	4.5	8.0	5.6																																								
11	Vibration	<p>Appearance: No defects or abnormalities</p> <p>Capacitance: Within the specified tolerance</p> <p>D.F.: B1, B3, R1, R6*, R7*, C7, C8, E7, D7: 0.1 max. C6: 0.125 max. D8: 0.15 max. F1, F5: 0.2 max. *GRM31CR71E106: 0.125 max. GRM31CR6 0J/0G 107: 0.15 max.</p>	<p>Solder the capacitor on the test jig (glass epoxy board) in the same manner and under the same conditions as (10).</p> <p>The capacitor should be subjected to a simple harmonic motion having a total amplitude of 1.5mm, the frequency being varied uniformly between the approximate limits of 10 and 55Hz. The frequency range, from 10 to 55Hz and return to 10Hz, should be traversed in approximately 1 minute. This motion should be applied for a period of 2 hours in each of 3 mutually perpendicular directions (total of 6 hours).</p>																																								
12	Deflection	<p>Appearance: No marking defects</p> <p>Capacitance Change: Within ±10%</p>  <p>Fig.3a</p>	<p>Solder the capacitor on the test jig (glass epoxy board) shown in Fig. 2a using an eutectic solder. Then apply a force in the direction shown in Fig. 3a for 5±1 sec. The soldering should be done by the reflow method and should be conducted with care so that the soldering is uniform and free of defects such as heat shock.</p>  <p>Fig. 2a</p> <p>(GRM02/03/15: t: 0.8mm)</p> <table border="1"> <thead> <tr> <th>Type</th> <th>a</th> <th>b</th> <th>c</th> </tr> </thead> <tbody> <tr> <td>GRM02</td> <td>0.2</td> <td>0.56</td> <td>0.23</td> </tr> <tr> <td>GRM03</td> <td>0.3</td> <td>0.9</td> <td>0.3</td> </tr> <tr> <td>GRM15</td> <td>0.4</td> <td>1.5</td> <td>0.5</td> </tr> <tr> <td>GRM18</td> <td>1.0</td> <td>3.0</td> <td>1.2</td> </tr> <tr> <td>GRM21</td> <td>1.2</td> <td>4.0</td> <td>1.65</td> </tr> <tr> <td>GRM31</td> <td>2.2</td> <td>5.0</td> <td>2.0</td> </tr> <tr> <td>GRM32</td> <td>2.2</td> <td>5.0</td> <td>2.9</td> </tr> <tr> <td>GRM43</td> <td>3.5</td> <td>7.0</td> <td>3.7</td> </tr> <tr> <td>GRM55</td> <td>4.5</td> <td>8.0</td> <td>5.6</td> </tr> </tbody> </table> <p>(in mm)</p>	Type	a	b	c	GRM02	0.2	0.56	0.23	GRM03	0.3	0.9	0.3	GRM15	0.4	1.5	0.5	GRM18	1.0	3.0	1.2	GRM21	1.2	4.0	1.65	GRM31	2.2	5.0	2.0	GRM32	2.2	5.0	2.9	GRM43	3.5	7.0	3.7	GRM55	4.5	8.0	5.6
Type	a	b	c																																								
GRM02	0.2	0.56	0.23																																								
GRM03	0.3	0.9	0.3																																								
GRM15	0.4	1.5	0.5																																								
GRM18	1.0	3.0	1.2																																								
GRM21	1.2	4.0	1.65																																								
GRM31	2.2	5.0	2.0																																								
GRM32	2.2	5.0	2.9																																								
GRM43	3.5	7.0	3.7																																								
GRM55	4.5	8.0	5.6																																								
13	Solderability of Termination	75% of the terminations is to be soldered evenly and continuously.	<p>Immerse the capacitor in a solution of ethanol (JIS-K-8101) and rosin (JIS-K-5902) (25% rosin in weight proportion). Preheat at 80 to 120°C for 10 to 30 seconds. After preheating, immerse in an eutectic solder solution for 2±0.5 seconds at 230±5°C or Sn-3.0Ag-0.5Cu solder solution for 2±0.5 seconds at 245±5°C.</p>																																								

Continued on the following page. ↗

GRM Series Specifications and Test Methods (2) (Note1) Typical Inspection

1

(Note1) This Specifications and Test Methods indicates typical inspection. Please refer to individual specifications (our product specifications or the approval sheet).
 In case Non "*" is added in PNs table, please refer to GRM Series Specifications and Test Methods (1).
 In case "*" is added in PNs table, please refer to GRM Series Specifications and Test Methods (2).

Continued from the preceding page.

No.	Item	Specifications	Test Method
14	Appearance	No defects or abnormalities	Preheat the capacitor at 120 to 150°C for 1 minute. Immerse the capacitor in an eutectic solder* or Sn-3.0Ag-0.5Cu solder solution at 270±5°C for 10±0.5 seconds. Set at room temperature for 24±2 hours, then measure. *Do not apply to GRM02. •Initial measurement for high dielectric constant type Perform a heat treatment at 150+0/-10°C for one hour and then set at room temperature for 24±2 hours. Perform the initial measurement. *Preheating for GRM32/43/55
	Capacitance Change	B1, B3, R1, R6*, R7, C6, C7, C8*, E7, D7, D8: Within ±7.5% F1, F5: Within ±20% *GRM188R6 0J/0G 106, GRM188C80E106, GRM219R60G226: within ±12.5% GRM155R60G475: Within ±15%	
	D.F.	B1, B3, R1, R6*, R7*, C7, C8, E7, D7: 0.1 max. C6: 0.125 max. D8: 0.15 max. F1, F5: 0.2 max. *GRM31CR71E106: 0.125 max. GRM31CR6 0J/0G 107: 0.15 max.	
	I.R.	More than 50Ω · F	
	Dielectric Strength	No defects	
15	Appearance	No defects or abnormalities	Fix the capacitor to the supporting jig in the same manner and under the same conditions as (10). Perform the five cycles according to the four heat treatments shown in the following table. Set for 24±2 hours at room temperature, then measure.
	Capacitance Change	B1, B3, R1, R6, R7, C6, C7, C8, D7, D8: Within ±7.5% E7: Within ±30% F1, F5: Within ±20%	
	D.F.	B1, B3, R1, R6*, R7*, C7, C8, E7, D7: 0.1 max. C6: 0.125 max. D8: 0.15 max. F1, F5: 0.2 max. *GRM31CR71E106: 0.125 max. GRM31CR6 0J/0G 107: 0.15 max.	
	I.R.	More than 50Ω · F	
	Dielectric Strength	No defects	
16	Appearance	No defects or abnormalities	Apply the rated voltage at 40±2°C and 90 to 95% humidity for 500±12 hours. The charge/discharge current is less than 50mA. •Initial measurement Perform a heat treatment at 150+0/-10°C for one hour and then let sit for 24±2 hours at room temperature. Perform the initial measurement. •Measurement after test Perform a heat treatment at 150+0/-10°C for one hour and then let sit for 24±2 hours at room temperature, then measure.
	Capacitance Change	B1, B3, R1, R6, R7, C6, C7, C8, E7, D7, D8: Within ±12.5% F1, F5: Within ±30%	
	D.F.	B1, B3, R1, R6, R7, C6, C7, C8, E7, D7, D8: 0.2 max. F1, F5: 0.4 max.	
	I.R.	More than 12.5Ω · F	
17	Appearance	No defects or abnormalities	Apply 150% of the rated voltage for 1000±12 hours at the maximum operating temperature ±3°C. Let sit for 24±2 hours at room temperature, then measure. The charge/discharge current is less than 50mA. •Initial measurement Perform a heat treatment at 150+0/-10°C for one hour and then let sit for 24±2 hours at room temperature. Perform the initial measurement. •Measurement after test Perform a heat treatment at 150+0/-10°C for one hour and then let sit for 24±2 hours at room temperature, then measure.
	Capacitance Change	B1, B3, R1, R6*, R7, C6, C7, C8*, E7, D7, D8: Within ±12.5% F1, F5: Within ±30% *GRM188C80E106, GRM219R60G226: within ±15%	
	D.F.	B1, B3, R1, R6, R7, C6, C7, C8, E7, D7, D8: 0.2 max. F1, F5: 0.4 max.	
	I.R.	More than 25Ω · F	

Step	Temperature	Time
1	100 to 120°C	1 min.
2	170 to 200°C	1 min.

Step	1	2	3	4
Temp. (°C)	Min. Operating Temp. +0/-3	Room Temp.	Max. Operating Temp. +3/-0	Room Temp.
Time (min.)	30±3	2 to 3	30±3	2 to 3

GRM Series Data

■ Capacitance - Temperature Characteristics

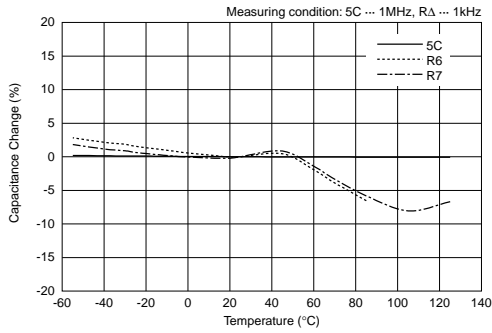

■ Capacitance Change - Aging

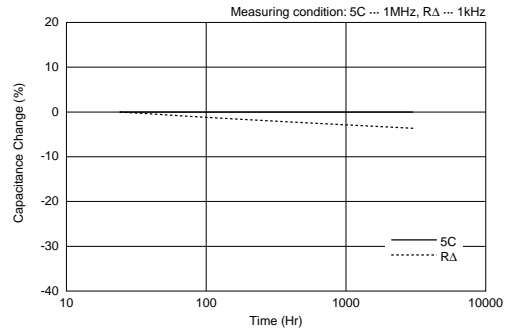

■ Impedance - Frequency Characteristics

5C: GRM15

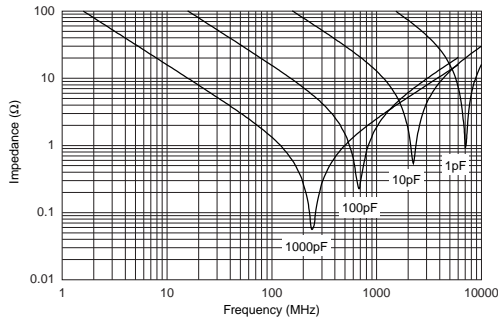

R Δ : GRM15

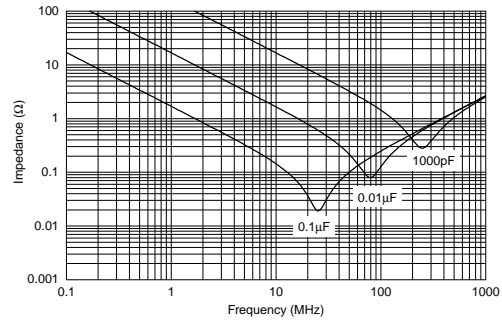

R Δ

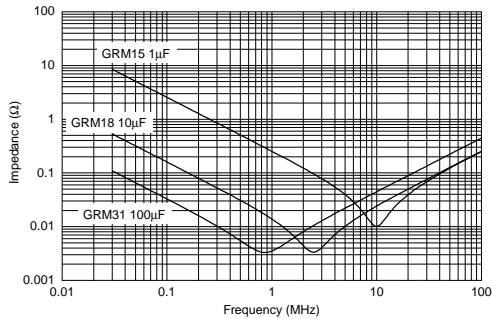

The data herein are given in typical values, not guaranteed ratings.
 Please refer to our Web site or contact our sales representatives for individual Part Number's data.
 Our Web Site: http://www.murata.com/products/capacitor/tech_data/index.html

Continued on the following page.

GRM Series Data

Continued from the preceding page.

Capacitance - DC Voltage Characteristics

Temperature Compensating Type: GRM1555C1H102JA01

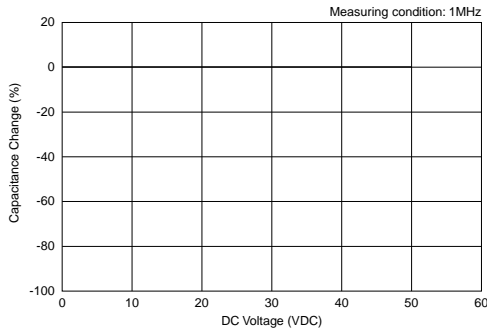

High Dielectric Constant Type: GRM155R71E103KA01

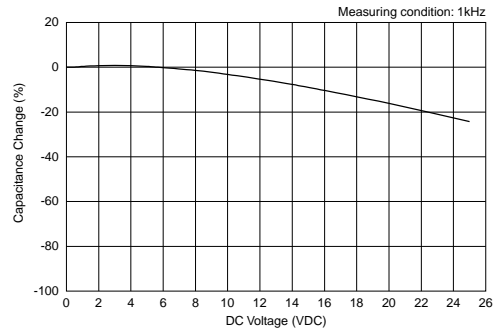

High Dielectric Constant Type: GRM155R71C104KA88

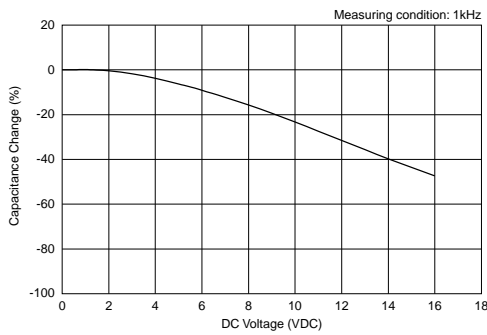

High Dielectric Constant Type: GRM155R61A105KE15

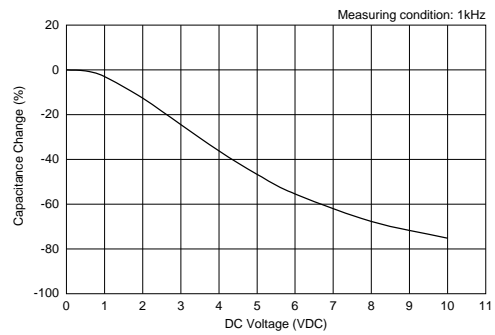

High Dielectric Constant Type: GRM188R60J106ME47

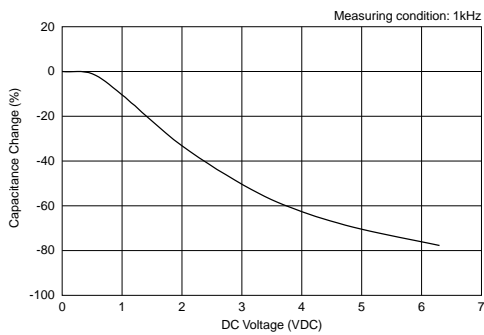

High Dielectric Constant Type: GRM31CR60J107ME39

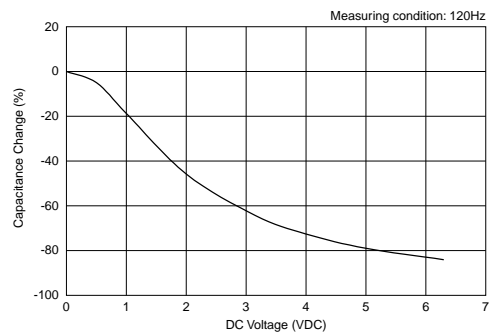

The data herein are given in typical values, not guaranteed ratings.
 Please refer to our Web site or contact our sales representatives for individual Part Number's data.
 Our Web Site: http://www.murata.com/products/capacitor/tech_data/index.html

Continued on the following page. ↗

GRM Series Data

Continued from the preceding page.

Capacitance - AC Voltage Characteristics

Temperature Compensating Type: GRM1555C1H102JA01

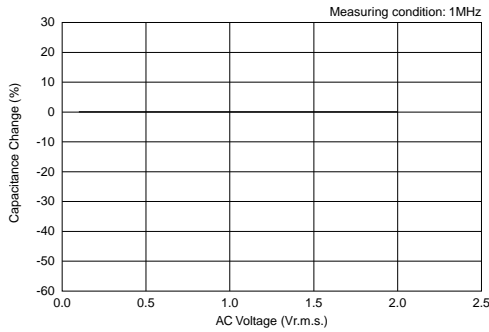

High Dielectric Constant Type: GRM155R71E103KA01

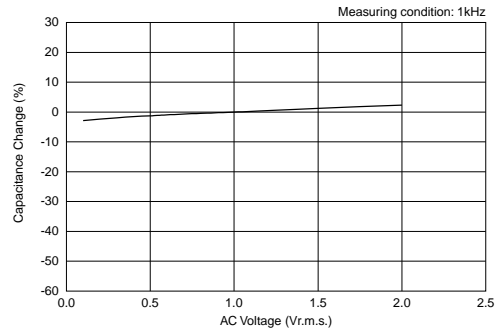

High Dielectric Constant Type: GRM155R71C104KA88

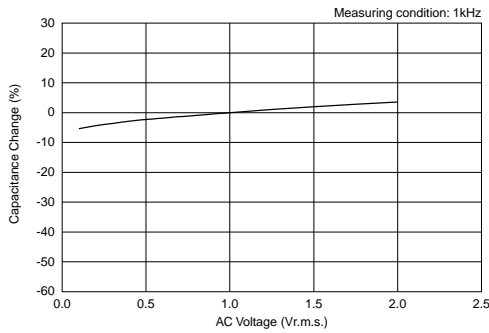

High Dielectric Constant Type: GRM155R61A105KE15

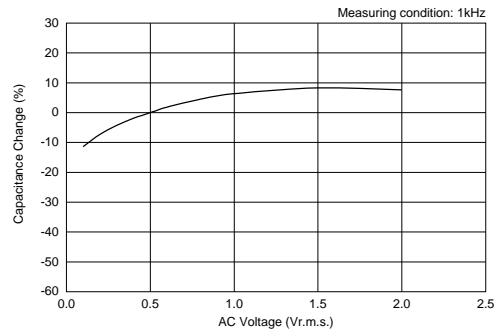

High Dielectric Constant Type: GRM188R60J106ME47

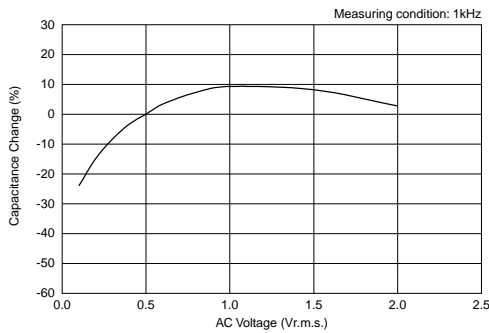

High Dielectric Constant Type: GRM31CR60J107ME39

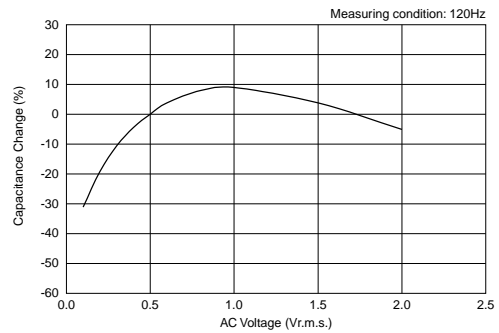

The data herein are given in typical values, not guaranteed ratings.
 Please refer to our Web site or contact our sales representatives for individual Part Number's data.
 Our Web Site: http://www.murata.com/products/capacitor/tech_data/index.html

Chip Monolithic Ceramic Capacitors



Capacitor Array GNM Series

■ Features

1. High density mounting due to mounting space saving
2. Mounting cost saving

■ Applications

General electronic equipment

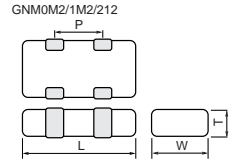
Part Number	Dimensions (mm)			
	L	W	T	P
GNM0M2	0.9 ±0.05	0.6 ±0.05	0.45 ±0.05	0.45 ±0.05
GNM1M2	1.37 ±0.15	1.0 ±0.15	0.5 +0.05/-0.10	0.64 ±0.05
			0.6 ±0.1	
			0.8 +0/-0.15	
GNM212	2.0 ±0.15	1.25 ±0.15	0.6 ±0.1	1.0 ±0.1
			0.85 ±0.1	

Part Number	Dimensions (mm)			
	L	W	T	P
GNM214	2.0 ±0.15	1.25 ±0.15	0.5 +0.05/-0.1	0.5 ±0.05
			0.6 ±0.1	
			0.85 ±0.1	
GNM314	3.2 ±0.15	1.6 ±0.15	0.8 ±0.1	0.8 ±0.1
			0.85 ±0.1	
			1.0 ±0.1	
			1.15 ±0.1	

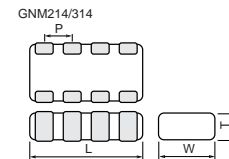
Capacitance Table

Temperature Compensating Type C0G(5C) Characteristics

0.6 ex.0.6: T Dimension [mm]

Capacitance	LxW [mm]	1.37x1.0	2.0x1.25	3.2x1.6	
		(1M) <0504>	(21) <0805>	(31) <1206>	(31) <1206>
Number of Elements		2(2)	4(4)		
Rated Voltage [Vdc]		50 (1H)	50 (1H)	100 (2A)	50 (1H)
10pF(100)		0.6	0.6	0.8	0.8
15pF(150)		0.6	0.6	0.8	0.8
22pF(220)		0.6	0.6	0.8	0.8
33pF(330)		0.6	0.6	0.8	0.8
47pF(470)		0.6	0.6	0.8	0.8
68pF(680)		0.6	0.6	0.8	0.8
100pF(101)		0.6	0.6	0.8	0.8
150pF(151)		0.6	0.6	0.8	0.8
220pF(221)		0.6	0.6		0.8
330pF(331)					0.8

The part number code is shown in () and Unit is shown in []. < >: EIA [inch] Code

Continued on the following page. ↗

Capacitance Table

Continued from the preceding page.

2

High Dielectric Constant Type X7R(R7)/X7S(C7) Characteristics

		0.6 ex.0.6: T Dimension [mm]											
LxW [mm]	Number of Elements	1.37x1.0 (1M) <0504>					2.0x1.25 (21) <0805>			3.2x1.6 (31) <1206>			
		2(2)					4(4)						
Rated Voltage [Vdc]		50 (1H)	25 (1E)	16 (1C)	10 (1A)	50 (1H)	25 (1E)	16 (1C)	50 (1H)	25 (1E)	16 (1C)	6.3 (0J)	
TC		X7R (R7)	X7R (R7)	X7R (R7)	X7R (R7)	X7S (C7)	X7R (R7)	X7R (R7)	X7R (R7)	X7R (R7)	X7R (R7)	X7R (R7)	
470pF(471)							0.6						
1000pF(102)	0.6						0.6						
2200pF(222)			0.6					0.6					
4700pF(472)			0.6					0.6					
10000pF(103)			0.6					0.6					
22000pF(223)				0.6	0.6				0.85				
47000pF(473)				0.6	0.6				0.85	0.85		1.0	
0.10μF(104)				0.6		0.6			0.85	0.85	0.85	1.0	
1.0μF(105)												1.15	

The part number code is shown in () and Unit is shown in []. < >: EIA [inch] Code

High Dielectric Constant Type X5R(R6) Characteristics

		0.6 ex.0.6: T Dimension [mm]															
LxW [mm]	Number of Elements	0.9x0.6 (0M) <0302>				1.37x1.0 (1M) <0504>					2.0x1.25 (21) <0805>			2.0x1.25 (21) <0805>		3.2x1.6 (31) <1206>	
		2(2)				4(4)											
Rated Voltage [Vdc]		16 (1C)	10 (1A)	6.3 (0J)	4 (0G)	50 (1H)	25 (1E)	16 (1C)	10 (1A)	6.3 (0J)	16 (1C)	10 (1A)	6.3 (0J)	10 (1A)	6.3 (0J)	16 (1C)	10 (1A)
TC		X5R (R6)	X5R (R6)	X5R (R6)	X5R (R6)	X5R (R6)	X5R (R6)	X5R (R6)	X5R (R6)	X5R (R6)	X5R (R6)	X5R (R6)	X5R (R6)	X5R (R6)	X5R (R6)	X5R (R6)	X5R (R6)
1000pF(102)						0.6											
2200pF(222)							0.6										
4700pF(472)							0.6										
10000pF(103)	0.45	0.45	0.45				0.6										
22000pF(223)	0.45	0.45	0.45					0.6	0.6								
47000pF(473)	0.45	0.45	0.45					0.6	0.6								
0.10μF(104)	0.45	0.45	0.45						0.6								
0.22μF(224)									0.8								
0.47μF(474)												0.85					
1.0μF(105)					0.45			0.8	0.8	0.8	0.85	0.85		0.85	0.85	0.85	0.85
2.2μF(225)								0.8	0.8			0.85	0.85		0.85		

The part number code is shown in () and Unit is shown in []. < >: EIA [inch] Code

High Dielectric Constant Type X7R(R7) Characteristics Low Profile

		0.5 ex.0.5: T Dimension [mm]	
LxW [mm]	Number of Elements	1.37x1.0 (1M) <0504>	2.0x1.25 (21) <0805>
		2(2)	4(4)
Rated Voltage [Vdc]		16 (1C)	16 (1C)
TC		X7R (R7)	X7R (R7)
0.10μF(104)		0.5	0.5

The part number code is shown in () and Unit is shown in []. < >: EIA [inch] Code

High Dielectric Constant Type X5R(R6) Characteristics Low Profile

		0.5 ex.0.5: T Dimension [mm]		
LxW [mm]	Number of Elements	1.37x1.0 (1M) <0504>	2.0x1.25 (21) <0805>	
		2(2)	4(4)	4(4)
Rated Voltage [Vdc]		16 (1C)	10 (1A)	16 (1C)
TC		X5R (R6)	X5R (R6)	X5R (R6)
1.0μF(105)		0.5	0.5	0.5

The part number code is shown in () and Unit is shown in []. < >: EIA [inch] Code

Temperature Compensating Type C0G(5C) Characteristics

LxW [mm]		1.37x1.0(1M)<0504>		2.0x1.25(21)<0805>		3.2x1.6(31)<1206>	
Rated Volt. [Vdc]		50(1H)		50(1H)		100(2A)	
Capacitance		Tolerance		Part Number			
10pF(100)	±10%(K)	GNM1M25C1H100KD01D	GNM2145C1H100KD01D	GNM3145C2A100KD01D	GNM3145C1H100KD01D		
15pF(150)	±10%(K)	GNM1M25C1H150KD01D	GNM2145C1H150KD01D	GNM3145C2A150KD01D	GNM3145C1H150KD01D		
22pF(220)	±10%(K)	GNM1M25C1H220KD01D	GNM2145C1H220KD01D	GNM3145C2A220KD01D	GNM3145C1H220KD01D		
33pF(330)	±10%(K)	GNM1M25C1H330KD01D	GNM2145C1H330KD01D	GNM3145C2A330KD01D	GNM3145C1H330KD01D		
47pF(470)	±10%(K)	GNM1M25C1H470KD01D	GNM2145C1H470KD01D	GNM3145C2A470KD01D	GNM3145C1H470KD01D		
68pF(680)	±10%(K)	GNM1M25C1H680KD01D	GNM2145C1H680KD01D	GNM3145C2A680KD01D	GNM3145C1H680KD01D		
100pF(101)	±10%(K)	GNM1M25C1H101KD01D	GNM2145C1H101KD01D	GNM3145C2A101KD01D	GNM3145C1H101KD01D		
150pF(151)	±10%(K)	GNM1M25C1H151KD01D	GNM2145C1H151KD01D	GNM3145C2A151KD01D	GNM3145C1H151KD01D		
220pF(221)	±10%(K)	GNM1M25C1H221KD01D	GNM2145C1H221KD01D		GNM3145C1H221KD01D		
330pF(331)	±10%(K)				GNM3145C1H331KD01D		

The part number code is shown in () and Unit is shown in []. < >: EIA [inch] Code

High Dielectric Constant Type X7R(R7)/X7S(C7) Characteristics

LxW [mm]		1.37x1.0(1M)<0504>			
Number of Elements		2(2)			
Rated Volt. [Vdc]		50(1H)		16(1C)	
Capacitance		Tolerance		Part Number	
1000pF(102)	±20%(M)	GNM1M2R71H102MA01D			
2200pF(222)	±20%(M)		GNM1M2R71E222MA01D		
4700pF(472)	±20%(M)		GNM1M2R71E472MA01D		
10000pF(103)	±20%(M)		GNM1M2R71E103MA01D		
22000pF(223)	±20%(M)			GNM1M2R71C223MA01D	GNM1M2R71A223MA01D
47000pF(473)	±20%(M)			GNM1M2R71C473MA01D	GNM1M2R71A473MA01D
0.10μF(104)	±20%(M)			GNM1M2R71C104MA01D	GNM1M2C71A104MA01D

LxW [mm]		2.0x1.25(21)<0805>		
Number of Elements		4(4)		
Rated Volt. [Vdc]		50(1H)		16(1C)
Capacitance		Tolerance		Part Number
470pF(471)	±20%(M)	GNM214R71H471MA01D		
1000pF(102)	±20%(M)	GNM214R71H102MA01D		
2200pF(222)	±20%(M)		GNM214R71E222MA01D	
4700pF(472)	±20%(M)		GNM214R71E472MA01D	
10000pF(103)	±20%(M)		GNM214R71E103MA01D	
22000pF(223)	±20%(M)			GNM214R71C223MA01D
47000pF(473)	±20%(M)			GNM214R71C473MA01D
0.10μF(104)	±20%(M)			GNM214R71C104MA01D

LxW [mm]		3.2x1.6(31)<1206>			
Number of Elements		4(4)			
Rated Volt. [Vdc]		50(1H)		16(1C)	
Capacitance		Tolerance		Part Number	
47000pF(473)	±20%(M)	GNM314R71H473MA11D		GNM314R71C473MA01L	
0.10μF(104)	±20%(M)	GNM314R71H104MA11D		GNM314R71C104MA01L	
1.0μF(105)	±20%(M)			GNM314R70J105MA01L	

The part number code is shown in () and Unit is shown in []. < >: EIA [inch] Code

*: Please refer to GNM series Specifications and Test Method(2).

(Part Number) **GN** **M** **1M** **2** **5C** **1H** **100** **K** **D01** **D** ①Product ID ②Series ③Dimension (LxW) ④Number of Elements
 ⑤Temperature Characteristics ⑥Rated Voltage ⑦Capacitance
 ⑧Capacitance Tolerance ⑨Individual Specification Code ⑩Packaging

Packaging Code in Part Number is a code shows STD 180mm Reel Taping.

High Dielectric Constant Type X5R(R6) Characteristics

2

LxW [mm]		0.9x0.6(0M)<0302>			
Number of Elements		2(2)			
Rated Volt. [Vdc]		16(1C)	10(1A)	6.3(0J)	4(0G)
Capacitance	Tolerance	Part Number			
10000pF(103)	±20%(M)	GNM0M2R61C103ME18D*	GNM0M2R61A103ME17D*	GNM0M2R60J103ME17D*	
22000pF(223)	±20%(M)	GNM0M2R61C223ME18D*	GNM0M2R61A223ME17D*	GNM0M2R60J223ME17D*	
47000pF(473)	±20%(M)	GNM0M2R61C473ME18D*	GNM0M2R61A473ME17D*	GNM0M2R60J473ME17D*	
0.10μF(104)	±20%(M)	GNM0M2R61C104ME18D*	GNM0M2R61A104ME17D*	GNM0M2R60J104ME17D*	
1.0μF(105)	±20%(M)				GNM0M2R60G105ME17D*

LxW [mm]		1.37x1.0(1M)<0504>		
Number of Elements		2(2)		
Rated Volt. [Vdc]		50(1H)	25(1E)	16(1C)
Capacitance	Tolerance	Part Number		
1000pF(102)	±20%(M)	GNM1M2R61H102MA01D		
2200pF(222)	±20%(M)		GNM1M2R61E222MA01D	
4700pF(472)	±20%(M)		GNM1M2R61E472MA01D	
10000pF(103)	±20%(M)		GNM1M2R61E103MA01D	
22000pF(223)	±20%(M)			GNM1M2R61C223MA01D
47000pF(473)	±20%(M)			GNM1M2R61C473MA01D
0.22μF(224)	±20%(M)			GNM1M2R61C224ME18D*
1.0μF(105)	±20%(M)			GNM1M2R61C105ME18D*

LxW [mm]		1.37x1.0(1M)<0504>		
Number of Elements		2(2)		
Rated Volt. [Vdc]		10(1A)	6.3(0J)	
Capacitance	Tolerance	Part Number		
22000pF(223)	±20%(M)	GNM1M2R61A223MA01D		
47000pF(473)	±20%(M)	GNM1M2R61A473MA01D		
0.10μF(104)	±20%(M)	GNM1M2R61A104MA01D		
1.0μF(105)	±20%(M)	GNM1M2R61A105ME17D*	GNM1M2R60J105ME12D*	
2.2μF(225)	±20%(M)	GNM1M2R61A225ME18D*	GNM1M2R60J225ME18D*	

LxW [mm]		2.0x1.25(21)<0805>		
Number of Elements		2(2)		
Rated Volt. [Vdc]		16(1C)	10(1A)	6.3(0J)
Capacitance	Tolerance	Part Number		
0.47μF(474)	±20%(M)	GNM212R61C474MA16D		
1.0μF(105)	±20%(M)	GNM212R61C105MA16D	GNM212R61A105MA13D	
2.2μF(225)	±20%(M)		GNM212R61A225ME16D*	GNM212R60J225ME16D*

The part number code is shown in () and Unit is shown in []. < >: EIA [inch] Code

*: Please refer to GNM series Specifications and Test Method(2).

(Part Number) **GN** **M** **0M** **2** **R6** **1C** **103** **M** **E18** **D**
 ① ② ③ ④ ⑤ ⑥ ⑦ ⑧ ⑨ ⑩

① Product ID ② Series
 ⑤ Temperature Characteristics ⑥ Rated Voltage ⑦ Capacitance
 ⑧ Capacitance Tolerance ⑨ Individual Specification Code ⑩ Packaging

Packaging Code in Part Number is a code shows STD Tray.

High Dielectric Constant Type X5R(R6) Characteristics

LxW [mm]		2.0x1.25(21)<0805>	
Number of Elements		4(4)	
Rated Volt. [Vdc]		10(1A)	6.3(0J)
Capacitance	Tolerance	Part Number	
1.0μF(105)	±20%(M)	GNM214R61A105ME17D*	GNM214R60J105ME17D*
2.2μF(225)	±20%(M)		GNM214R60J225ME18D*

LxW [mm]		3.2x1.6(31)<1206>	
Number of Elements		4(4)	
Rated Volt. [Vdc]		16(1C)	10(1A)
Capacitance	Tolerance	Part Number	
1.0μF(105)	±20%(M)	GNM314R61C105MA15D	GNM314R61A105MA13D

The part number code is shown in () and Unit is shown in []. < >: EIA [inch] Code

*: Please refer to GNM series Specifications and Test Method(2).

High Dielectric Constant Type X7R(R7) Characteristics Low Profile

LxW [mm]		1.37x1.0(1M)<0504>	2.0x1.25(21)<0805>
Number of Elements		2(2)	4(4)
Rated Volt. [Vdc]		16(1C)	16(1C)
Capacitance	Tolerance	Part Number	
0.10μF(104)	±20%(M)	GNM1M2R71C104MAA1D	GNM214R71C104MAA1D

High Dielectric Constant Type X5R(R6) Characteristics Low Profile

LxW [mm]		1.37x1.0(1M)<0504>	
Number of Elements		2(2)	
Rated Volt. [Vdc]		16(1C)	10(1A)
Capacitance	Tolerance	Part Number	
1.0μF(105)	±20%(M)	GNM1M2R61C105MEA2D*	GNM1M2R61A105MEA4D*

The part number code is shown in () and Unit is shown in []. < >: EIA [inch] Code

*: Please refer to GNM series Specifications and Test Method(2).

GNM Series Specifications and Test Methods (1)

In case Non "*" is added in PNs table, please refer to GNM Series Specifications and Test Methods (1).
 In case "*" is added in PNs table, please refer to GNM Series Specifications and Test Methods (2).

2

No.	Item	Specifications		Test Method																										
		Temperature Compensating Type	High Dielectric Type																											
1	Operating Temperature Range	5C: -55 to +125°C	R7, C7: -55 to +125°C R6: -55 to +85°C																											
2	Rated Voltage	See the previous pages.		The rated voltage is defined as the maximum voltage which may be applied continuously to the capacitor. When AC voltage is superimposed on DC voltage, V^{P-P} or V^{O-P} , whichever is larger, should be maintained within the rated voltage range.																										
3	Appearance	No defects or abnormalities		Visual inspection																										
4	Dimensions	Within the specified dimensions		Using calipers																										
5	Dielectric Strength	No defects or abnormalities		No failure should be observed when 300% of the rated voltage (5C) or 250% of the rated voltage (R7) is applied between the terminations for 1 to 5 seconds, provided the charge/discharge current is less than 50mA.																										
6	Insulation Resistance	More than 10,000MΩ or 500Ω · F (Whichever is smaller)		The insulation resistance should be measured with a DC voltage not exceeding the rated voltage at 25°C and 75%RH max. and within 2 minutes of charging.																										
7	Capacitance	Within the specified tolerance		The capacitance/Q/D.F. should be measured at 25°C at the frequency and voltage shown in the table.																										
8	Q/ Dissipation Factor (D.F.)	30pF min.: $Q \geq 1000$ 30pF max.: $Q \geq 400+20C$ C: Nominal Capacitance (pF)	<table border="1"> <thead> <tr> <th>Char.</th> <th>25V min.</th> <th>16V</th> <th>10V</th> <th>6.3V</th> </tr> </thead> <tbody> <tr> <td>R7, R6, C7</td> <td>0.025 max.</td> <td>0.035 max.</td> <td>0.035 max.</td> <td>0.05 max.</td> </tr> </tbody> </table>	Char.	25V min.	16V	10V	6.3V	R7, R6, C7	0.025 max.	0.035 max.	0.035 max.	0.05 max.	<table border="1"> <thead> <tr> <th>Char.</th> <th>5C</th> <th>R7</th> </tr> </thead> <tbody> <tr> <td>Item</td> <td></td> <td></td> </tr> <tr> <td>Frequency</td> <td>1±0.1MHz</td> <td>1±0.1kHz</td> </tr> <tr> <td>Voltage</td> <td>0.5 to 5Vrms</td> <td>1.0±0.2Vrms</td> </tr> </tbody> </table>	Char.	5C	R7	Item			Frequency	1±0.1MHz	1±0.1kHz	Voltage	0.5 to 5Vrms	1.0±0.2Vrms				
			Char.	25V min.	16V	10V	6.3V																							
R7, R6, C7	0.025 max.	0.035 max.	0.035 max.	0.05 max.																										
Char.	5C	R7																												
Item																														
Frequency	1±0.1MHz	1±0.1kHz																												
Voltage	0.5 to 5Vrms	1.0±0.2Vrms																												
9	Capacitance Temperature Characteristics	Capacitance Change	<table border="1"> <thead> <tr> <th>Char.</th> <th>Temp. Range</th> <th>Reference Temp.</th> <th>Cap. Change</th> </tr> </thead> <tbody> <tr> <td>R7</td> <td>-55°C to +125°C</td> <td rowspan="3">25°C</td> <td>Within ±15%</td> </tr> <tr> <td>R6</td> <td>-55°C to +85°C</td> <td></td> </tr> <tr> <td>C7</td> <td>-55°C to +125°C</td> <td>Within ±22%</td> </tr> </tbody> </table>	Char.	Temp. Range	Reference Temp.	Cap. Change	R7	-55°C to +125°C	25°C	Within ±15%	R6	-55°C to +85°C		C7	-55°C to +125°C	Within ±22%	The capacitance change should be measured after 5 min. at each specified temperature stage. (1) Temperature Compensating Type The temperature coefficient is determined using the capacitance measured in step 3 as a reference. When cycling the temperature sequentially from step1 through 5, the capacitance should be within the specified tolerance for the temperature coefficient and capacitance change as Table A. The capacitance drift is calculated by dividing the differences between the maximum and minimum measured values in the steps 1, 3 and 5 by the cap. value in step 3. <table border="1"> <thead> <tr> <th>Step</th> <th>Temperature (°C)</th> </tr> </thead> <tbody> <tr> <td>1</td> <td>25±2</td> </tr> <tr> <td>2</td> <td>-55±3 (for 5C/R7/C7), -30±3 (for F5)</td> </tr> <tr> <td>3</td> <td>25±2</td> </tr> <tr> <td>4</td> <td>125±3 (for 5C/R7/C7), 85±3 (for F5)</td> </tr> <tr> <td>5</td> <td>25±2</td> </tr> </tbody> </table> (2) High Dielectric Constant Type The ranges of capacitance change compared with the above 25°C value over the temperature ranges shown in the table should be within the specified ranges.	Step	Temperature (°C)	1	25±2	2	-55±3 (for 5C/R7/C7), -30±3 (for F5)	3	25±2	4	125±3 (for 5C/R7/C7), 85±3 (for F5)	5	25±2
		Char.	Temp. Range	Reference Temp.	Cap. Change																									
		R7	-55°C to +125°C	25°C	Within ±15%																									
R6	-55°C to +85°C																													
C7	-55°C to +125°C	Within ±22%																												
Step	Temperature (°C)																													
1	25±2																													
2	-55±3 (for 5C/R7/C7), -30±3 (for F5)																													
3	25±2																													
4	125±3 (for 5C/R7/C7), 85±3 (for F5)																													
5	25±2																													
Temperature Coefficient	Within the specified tolerance (Table A)																													
Capacitance Drift	Within ±0.2% or ±0.05pF (Whichever is larger.)																													
10	Adhesive Strength of Termination	No removal of the terminations or other defect should occur. 		Solder the capacitor to the test jig (glass epoxy board) shown in Fig.1 using a eutectic solder. Then apply 5N force in parallel with the test jig for 10±1 sec. The soldering should be done either with an iron or using the reflow method and should be conducted with care so that the soldering is uniform and free of defects such as heat shock. <table border="1"> <thead> <tr> <th>Type</th> <th>a</th> <th>b</th> <th>c</th> <th>d</th> </tr> </thead> <tbody> <tr> <td>GNM1M2</td> <td>0.5</td> <td>1.6</td> <td>0.32</td> <td>0.32</td> </tr> <tr> <td>GNM212</td> <td>0.6</td> <td>1.8</td> <td>0.5</td> <td>0.5</td> </tr> <tr> <td>GNM214</td> <td>0.6</td> <td>2.0</td> <td>0.25</td> <td>0.25</td> </tr> <tr> <td>GNM314</td> <td>0.8</td> <td>2.5</td> <td>0.4</td> <td>0.4</td> </tr> </tbody> </table> (in mm)	Type	a	b	c	d	GNM1M2	0.5	1.6	0.32	0.32	GNM212	0.6	1.8	0.5	0.5	GNM214	0.6	2.0	0.25	0.25	GNM314	0.8	2.5	0.4	0.4	
Type	a	b	c	d																										
GNM1M2	0.5	1.6	0.32	0.32																										
GNM212	0.6	1.8	0.5	0.5																										
GNM214	0.6	2.0	0.25	0.25																										
GNM314	0.8	2.5	0.4	0.4																										

Fig. 1

Continued on the following page. 

GNM Series Specifications and Test Methods (1)

Continued from the preceding page.

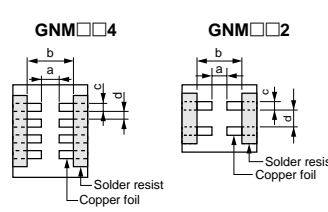
**In case Non "*" is added in PNs table, please refer to GNM Series Specifications and Test Methods (1).
 In case "*" is added in PNs table, please refer to GNM Series Specifications and Test Methods (2).**

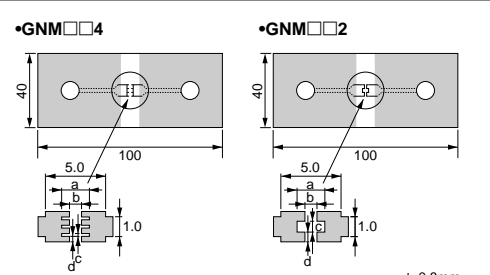
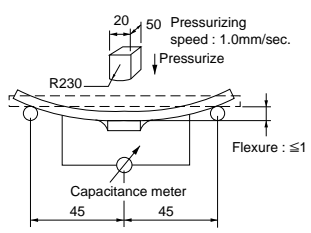
No.	Item	Specifications		Test Method																										
		Temperature Compensating Type	High Dielectric Type																											
11	Vibration Resistance	Appearance	No defects or abnormalities		Solder the capacitor to the test jig (glass epoxy board) in the same manner and under the same conditions as (10). The capacitor should be subjected to a simple harmonic motion having a total amplitude of 1.5mm, the frequency being varied uniformly between the approximate limits of 10 and 55Hz. The frequency range, from 10 to 55Hz and return to 10Hz, should be traversed in approximately 1 minute. This motion should be applied for a period of 2 hours in each of 3 mutually perpendicular directions (total of 6 hours).																									
	Capacitance	Within the specified tolerance																												
12	Deflection	Q/D.F.	30pF min.: $Q \geq 1000$ 30pF max.: $Q \geq 400+20C$ C: Nominal Capacitance (pF)		Solder the capacitor on the test jig (glass epoxy board) shown in Fig. 2 using a eutectic solder. Then apply a force in the direction shown in Fig. 3 for 5 ± 1 sec. The soldering should be done by the reflow method and should be conducted with care so that the soldering is uniform and free of defects such as heat shock.																									
		Appearance	No marking defects																											
13	Solderability of Termination	Capacitance Change	Within $\pm 5\%$ or $\pm 0.5\text{pF}$ (Whichever is larger)	Within $\pm 10\%$	 <table border="1" style="margin: 10px auto;"> <thead> <tr> <th>Type</th> <th>a</th> <th>b</th> <th>c</th> <th>d</th> </tr> </thead> <tbody> <tr> <td>GNM1M2</td> <td>2.0 ± 0.05</td> <td>0.5 ± 0.05</td> <td>0.32 ± 0.05</td> <td>0.32 ± 0.05</td> </tr> <tr> <td>GNM212</td> <td>2.0 ± 0.05</td> <td>0.6 ± 0.05</td> <td>0.5 ± 0.05</td> <td>0.5 ± 0.05</td> </tr> <tr> <td>GNM214</td> <td>2.0 ± 0.05</td> <td>0.7 ± 0.05</td> <td>0.3 ± 0.05</td> <td>0.2 ± 0.05</td> </tr> <tr> <td>GNM314</td> <td>2.5 ± 0.05</td> <td>0.8 ± 0.05</td> <td>0.4 ± 0.05</td> <td>0.4 ± 0.05</td> </tr> </tbody> </table> <p style="text-align: center;">(in mm)</p>	Type	a	b	c	d	GNM1M2	2.0 ± 0.05	0.5 ± 0.05	0.32 ± 0.05	0.32 ± 0.05	GNM212	2.0 ± 0.05	0.6 ± 0.05	0.5 ± 0.05	0.5 ± 0.05	GNM214	2.0 ± 0.05	0.7 ± 0.05	0.3 ± 0.05	0.2 ± 0.05	GNM314	2.5 ± 0.05	0.8 ± 0.05	0.4 ± 0.05	0.4 ± 0.05
		Type	a	b		c	d																							
GNM1M2	2.0 ± 0.05	0.5 ± 0.05	0.32 ± 0.05	0.32 ± 0.05																										
GNM212	2.0 ± 0.05	0.6 ± 0.05	0.5 ± 0.05	0.5 ± 0.05																										
GNM214	2.0 ± 0.05	0.7 ± 0.05	0.3 ± 0.05	0.2 ± 0.05																										
GNM314	2.5 ± 0.05	0.8 ± 0.05	0.4 ± 0.05	0.4 ± 0.05																										
Capacitance Change	Within $\pm 5\%$ or $\pm 0.5\text{pF}$ (Whichever is larger)	Within $\pm 10\%$	 <p style="text-align: center;">Fig. 3</p>																											
Appearance	No marking defects																													
14	Resistance to Soldering Heat	Appearance	No marking defects		Immerse the capacitor in a solution of ethanol (JIS-K-8101) and rosin (JIS-K-5902) (25% rosin in weight proportion). Preheat at 80 to 120°C for 10 to 30 seconds. After preheating, immerse in eutectic solder solution for 2 ± 0.5 seconds at $230 \pm 5^\circ\text{C}$ or Sn-3.0Ag-0.5Cu solder solution for 2 ± 0.5 seconds at $245 \pm 5^\circ\text{C}$.																									
		Capacitance Change	Within $\pm 2.5\%$ or $\pm 0.25\text{pF}$ (Whichever is larger)	R7, R6, C7: Within $\pm 7.5\%$																										
14	Resistance to Soldering Heat	Q/D.F.	30pF min.: $Q \geq 1000$ 30pF max.: $Q \geq 400+20C$ C: Nominal Capacitance (pF)		Preheat the capacitor at 120 to 150°C for 1 minute. Immerse the capacitor in a eutectic solder or Sn-3.0Ag-0.5Cu solder solution at $270 \pm 5^\circ\text{C}$ for 10 ± 0.5 seconds. Let sit at room temperature for 24 ± 2 hours, then measure.																									
		I.R.	More than $10,000\text{M}\Omega$ or $500\Omega \cdot \text{F}$ (Whichever is smaller)																											
		Dielectric Strength	No failure																											
		Appearance	No marking defects																											

Continued on the following page.

GNM Series Specifications and Test Methods (1)

Continued from the preceding page.

In case Non "*" is added in PNs table, please refer to GNM Series Specifications and Test Methods (1).
 In case "**" is added in PNs table, please refer to GNM Series Specifications and Test Methods (2).

2

No.	Item	Specifications				Test Method															
		Temperature Compensating Type	High Dielectric Type																		
15	Temperature Cycle	The measured and observed characteristics should satisfy the specifications in the following table.				Fix the capacitor to the supporting jig in the same manner and under the same conditions as (10). Perform the five cycles according to the four heat treatments listed in the following table. Let sit for 24±2 hours (temperature compensating type) or 48±4 hours (high dielectric constant type) at room temperature, then measure. <table border="1" style="margin-top: 10px;"> <thead> <tr> <th>Step</th> <th>1</th> <th>2</th> <th>3</th> <th>4</th> </tr> </thead> <tbody> <tr> <td>Temp. (°C)</td> <td>Min. Operating Temp. +0/-3</td> <td>Room Temp.</td> <td>Max. Operating Temp. +3/-0</td> <td>Room Temp.</td> </tr> <tr> <td>Time (min.)</td> <td>30±3</td> <td>2 to 3</td> <td>30±3</td> <td>2 to 3</td> </tr> </tbody> </table> <ul style="list-style-type: none"> • Initial measurement for high dielectric constant type Perform a heat treatment at 150+0/-10°C for one hour and then let sit for 24±2 hours at room temperature. Perform the initial measurement. 	Step	1	2	3	4	Temp. (°C)	Min. Operating Temp. +0/-3	Room Temp.	Max. Operating Temp. +3/-0	Room Temp.	Time (min.)	30±3	2 to 3	30±3	2 to 3
	Step	1	2	3	4																
	Temp. (°C)	Min. Operating Temp. +0/-3	Room Temp.	Max. Operating Temp. +3/-0	Room Temp.																
	Time (min.)	30±3	2 to 3	30±3	2 to 3																
	Appearance	No marking defects																			
	Capacitance Change	Within ±2.5% or ±0.25pF (Whichever is larger)	R7, R6, C7: Within ±7.5%																		
Q/D.F.	30pF min.: Q≥1000 30pF max.: Q≥400+20C C: Nominal Capacitance (pF)	<table border="1" style="font-size: small;"> <thead> <tr> <th>Char.</th> <th>25V min.</th> <th>16V</th> <th>10V</th> <th>6.3V</th> </tr> </thead> <tbody> <tr> <td>R7, R6, C7</td> <td>0.025 max.</td> <td>0.035 max.</td> <td>0.035 max.</td> <td>0.05 max.</td> </tr> </tbody> </table>	Char.	25V min.	16V	10V	6.3V	R7, R6, C7	0.025 max.	0.035 max.	0.035 max.	0.05 max.									
Char.	25V min.	16V	10V	6.3V																	
R7, R6, C7	0.025 max.	0.035 max.	0.035 max.	0.05 max.																	
I.R.	More than 10,000MΩ or 500Ω · F (Whichever is smaller)																				
Dielectric Strength	No failure																				
16	Humidity Steady State	The measured and observed characteristics should satisfy the specifications in the following table.				Sit the capacitor at 40±2°C and 90 to 95% humidity for 500±12 hours. Remove and let sit for 24±2 hours at room temperature, then measure.															
	Appearance	No marking defects																			
	Capacitance Change	Within ±5% or ±0.5pF (Whichever is larger)	R7, R6, C7: Within ±12.5%																		
	Q/D.F.	30pF and over: Q≥350 10pF and over, 30pF and below: Q≥275+5C/2 10pF and below: Q≥200+10C C: Nominal Capacitance (pF)	<table border="1" style="font-size: small;"> <thead> <tr> <th>Char.</th> <th>25V min.</th> <th>16V</th> <th>10V/6.3V</th> </tr> </thead> <tbody> <tr> <td>R7, R6, C7</td> <td>0.05 max.</td> <td>0.05 max.</td> <td>0.05 max.</td> </tr> </tbody> </table>	Char.	25V min.		16V	10V/6.3V	R7, R6, C7	0.05 max.	0.05 max.	0.05 max.									
	Char.	25V min.	16V	10V/6.3V																	
R7, R6, C7	0.05 max.	0.05 max.	0.05 max.																		
I.R.	More than 1,000MΩ or 50Ω · F (Whichever is smaller)																				
17	Humidity Load	The measured and observed characteristics should satisfy the specifications in the following table.				Apply the rated voltage at 40±2°C and 90 to 95% humidity for 500±12 hours. Remove and let sit for 24±2 hours at room temperature, then measure. The charge/discharge current is less than 50mA.															
	Appearance	No marking defects																			
	Capacitance Change	Within ±7.5% or ±0.75pF (Whichever is larger)	R7, R6, C7: Within ±12.5%																		
	Q/D.F.	30pF and over: Q≥200 30pF and below: Q≥100+10C/3 C: Nominal Capacitance (pF)	<table border="1" style="font-size: small;"> <thead> <tr> <th>Char.</th> <th>25V min.</th> <th>16V</th> <th>10V/6.3V</th> </tr> </thead> <tbody> <tr> <td>R7, R6, C7</td> <td>0.05 max.</td> <td>0.05 max.</td> <td>0.05 max.</td> </tr> </tbody> </table>	Char.	25V min.		16V	10V/6.3V	R7, R6, C7	0.05 max.	0.05 max.	0.05 max.									
	Char.	25V min.	16V	10V/6.3V																	
R7, R6, C7	0.05 max.	0.05 max.	0.05 max.																		
I.R.	More than 500MΩ or 25Ω · F (Whichever is smaller)																				

Continued on the following page.

GNM Series Specifications and Test Methods (1)

Continued from the preceding page.

**In case Non "" is added in PNs table, please refer to GNM Series Specifications and Test Methods (1).
 In case "" is added in PNs table, please refer to GNM Series Specifications and Test Methods (2).**

No.	Item	Specifications		Test Method									
		Temperature Compensating Type	High Dielectric Type										
18	High Temperature Load	The measured and observed characteristics should satisfy the specifications in the following table.		Apply 200% of the rated voltage for 1000±12 hours at the maximum operating temperature ±3°C. Let sit for 24±2 hours at room temperature, then measure. The charge/discharge current is less than 50mA. • Initial measurement for high dielectric constant type. Apply 200% of the rated DC voltage for one hour at the maximum operating temperature ±3°C. Remove and let sit for 24±2 hours at room temperature. Perform initial measurement.									
	Appearance	No marking defects											
	Capacitance Change	Within ±3% or ±0.3pF (Whichever is larger)	R7, R6, C7: Within ±12.5%										
	Q/D.F.	30pF and over: $Q \geq 350$ 10pF and over, 30pF and below: $Q \geq 275 + 5C/2$ 10pF and below: $Q \geq 200 + 10C$ C: Nominal Capacitance (pF)	<table border="1" style="width: 100%; border-collapse: collapse; text-align: center;"> <thead> <tr> <th>Char.</th> <th>25V min.</th> <th>16V</th> <th>10V/6.3V</th> </tr> </thead> <tbody> <tr> <td>R7, R6, C7</td> <td>0.04 max.</td> <td>0.05 max.</td> <td>0.05 max.</td> </tr> </tbody> </table>		Char.	25V min.	16V	10V/6.3V	R7, R6, C7	0.04 max.	0.05 max.	0.05 max.	
	Char.	25V min.	16V		10V/6.3V								
R7, R6, C7	0.04 max.	0.05 max.	0.05 max.										
I.R.	More than 1,000MΩ or 50Ω · F (Whichever is smaller)												

2

Table A

Char.	Nominal Values (ppm/°C) Note 1	Capacitance Change from 25°C (%)					
		-55°C		-30°C		-10°C	
		Max.	Min.	Max.	Min.	Max.	Min.
5C	0±30	0.58	-0.24	0.40	-0.17	0.25	-0.11

Note 1: Nominal values denote the temperature coefficient within a range of 25 to 125°C.

GNM Series Specifications and Test Methods (2)

In case Non "*" is added in PNs table, please refer to GNM Series Specifications and Test Methods (1).
 In case "**" is added in PNs table, please refer to GNM Series Specifications and Test Methods (2).

2

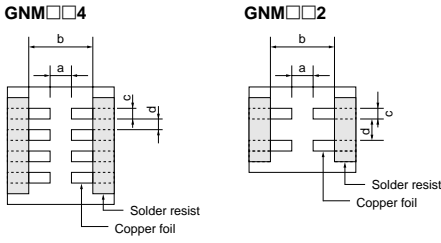
No.	Item	Specifications	Test Method																														
1	Operating Temperature Range	R6: -55°C to +85°C																															
2	Rated Voltage	See the previous pages.	The rated voltage is defined as the maximum voltage which may be applied continuously to the capacitor. When AC voltage is superimposed on DC voltage, V^{P-P} or V^{O-P} , whichever is larger, should be maintained within the rated voltage range.																														
3	Appearance	No defects or abnormalities	Visual inspection																														
4	Dimensions	Within the specified dimension	Using calipers																														
5	Dielectric Strength	No defects or abnormalities	No failure should be observed when 250% of the rated voltage is applied between the terminations for 1 to 5 seconds, provided the charge/discharge current is less than 50mA.																														
6	Insulation Resistance	50Ω · F min.	The insulation resistance should be measured with a DC voltage not exceeding the rated voltage at 25°C and 75%RH max. and within 1 minute of charging.																														
7	Capacitance	Within the specified tolerance	The capacitance/D.F. should be measured at 25°C at the frequency and voltage shown in the table. <table border="1"> <thead> <tr> <th>Nominal Capacitance</th> <th>Measuring Frequency</th> <th>Measuring Voltage</th> </tr> </thead> <tbody> <tr> <td>$C \leq 10\mu F$ *1 (10V min.)</td> <td>1±0.1kHz</td> <td>1.0±0.2Vrms</td> </tr> <tr> <td>$C \leq 10\mu F$ *2 (6.3V max.)</td> <td>1±0.1kHz</td> <td>0.5±0.1Vrms</td> </tr> <tr> <td>*1 For items in Table1</td> <td>1±0.1kHz</td> <td>0.5±0.1Vrms</td> </tr> <tr> <td>*2 For items in Table2</td> <td>1±0.1kHz</td> <td>1.0±0.1Vrms</td> </tr> </tbody> </table>	Nominal Capacitance	Measuring Frequency	Measuring Voltage	$C \leq 10\mu F$ *1 (10V min.)	1±0.1kHz	1.0±0.2Vrms	$C \leq 10\mu F$ *2 (6.3V max.)	1±0.1kHz	0.5±0.1Vrms	*1 For items in Table1	1±0.1kHz	0.5±0.1Vrms	*2 For items in Table2	1±0.1kHz	1.0±0.1Vrms															
Nominal Capacitance	Measuring Frequency	Measuring Voltage																															
$C \leq 10\mu F$ *1 (10V min.)	1±0.1kHz	1.0±0.2Vrms																															
$C \leq 10\mu F$ *2 (6.3V max.)	1±0.1kHz	0.5±0.1Vrms																															
*1 For items in Table1	1±0.1kHz	0.5±0.1Vrms																															
*2 For items in Table2	1±0.1kHz	1.0±0.1Vrms																															
8	Dissipation Factor (D.F.)	0.1 max.*3 Table 3 <table border="1"> <thead> <tr> <th>GNM0M2 R6 103/223/473/104</th> </tr> </thead> <tbody> <tr> <td>GNM1M2 R6 0J 105/225</td> </tr> <tr> <td>GNM1M2 R6 1A 225</td> </tr> <tr> <td>GNM212 R6 0J 225</td> </tr> <tr> <td>GNM212 R6 1A 225</td> </tr> <tr> <td>GNM214 R6 0J 225</td> </tr> </tbody> </table> *3 However 0.125 max. about Table 3 items.	GNM0M2 R6 103/223/473/104	GNM1M2 R6 0J 105/225	GNM1M2 R6 1A 225	GNM212 R6 0J 225	GNM212 R6 1A 225	GNM214 R6 0J 225	<table border="1"> <thead> <tr> <th colspan="3">Table 1</th> </tr> </thead> <tbody> <tr> <td>GNM0M2 R6 1A 104</td> </tr> <tr> <td>GNM0M2 R6 1C 104</td> </tr> <tr> <td>GNM1M2 R6 1A 105/225</td> </tr> <tr> <td>GNM1M2 R6 1C 224/105</td> </tr> </tbody> </table> <table border="1"> <thead> <tr> <th colspan="3">Table 2</th> </tr> </thead> <tbody> <tr> <td>GNM0M2 R6 0J 103/223/473</td> </tr> <tr> <td>GNM212 R6 0J 225</td> </tr> <tr> <td>GNM214 R6 0J 105</td> </tr> </tbody> </table>	Table 1			GNM0M2 R6 1A 104	GNM0M2 R6 1C 104	GNM1M2 R6 1A 105/225	GNM1M2 R6 1C 224/105	Table 2			GNM0M2 R6 0J 103/223/473	GNM212 R6 0J 225	GNM214 R6 0J 105											
GNM0M2 R6 103/223/473/104																																	
GNM1M2 R6 0J 105/225																																	
GNM1M2 R6 1A 225																																	
GNM212 R6 0J 225																																	
GNM212 R6 1A 225																																	
GNM214 R6 0J 225																																	
Table 1																																	
GNM0M2 R6 1A 104																																	
GNM0M2 R6 1C 104																																	
GNM1M2 R6 1A 105/225																																	
GNM1M2 R6 1C 224/105																																	
Table 2																																	
GNM0M2 R6 0J 103/223/473																																	
GNM212 R6 0J 225																																	
GNM214 R6 0J 105																																	
9	Capacitance Temperature Characteristics	<table border="1"> <thead> <tr> <th>Char.</th> <th>Temp. Range</th> <th>Reference Temp.</th> <th>Cap. Change</th> </tr> </thead> <tbody> <tr> <td>R6</td> <td>-55 to +85°C</td> <td>25°C</td> <td>Within ±15%</td> </tr> </tbody> </table>	Char.	Temp. Range	Reference Temp.	Cap. Change	R6	-55 to +85°C	25°C	Within ±15%	The capacitance change should be measured after 5 min. at each specified temperature stage. <table border="1"> <thead> <tr> <th>Step</th> <th>Temperature (°C)</th> </tr> </thead> <tbody> <tr> <td>1</td> <td>25±2</td> </tr> <tr> <td>2</td> <td>-55±3</td> </tr> <tr> <td>3</td> <td>25±2</td> </tr> <tr> <td>4</td> <td>85±3</td> </tr> <tr> <td>5</td> <td>25±2</td> </tr> </tbody> </table> The ranges of capacitance change compared with the 25°C value over the temperature ranges shown in the table should be within the specified ranges. • Initial measurement for high dielectric constant type. Perform a heat treatment at 150+0/-10°C for one hour and then set for 24±2 hours at room temperature. Perform the initial measurement.	Step	Temperature (°C)	1	25±2	2	-55±3	3	25±2	4	85±3	5	25±2										
Char.	Temp. Range	Reference Temp.	Cap. Change																														
R6	-55 to +85°C	25°C	Within ±15%																														
Step	Temperature (°C)																																
1	25±2																																
2	-55±3																																
3	25±2																																
4	85±3																																
5	25±2																																
10	Adhesive Strength of Termination	No removal of the terminations or other defects should occur. 	Solder the capacitor to the test jig (glass epoxy board) shown in Fig. 1 using a eutectic solder. Then apply 5N (GNM0M2: 2N) force in parallel with the test jig for 10±1 sec. The soldering should be done either with an iron or using the reflow method and should be conducted with care so that the soldering is uniform and free of defects such as heat shock. <table border="1"> <thead> <tr> <th>Type</th> <th>a</th> <th>b</th> <th>c</th> <th>d</th> </tr> </thead> <tbody> <tr> <td>GNM0M2</td> <td>0.2</td> <td>0.96</td> <td>0.25</td> <td>0.2</td> </tr> <tr> <td>GNM1M2</td> <td>0.5</td> <td>1.6</td> <td>0.32</td> <td>0.32</td> </tr> <tr> <td>GNM212</td> <td>0.6</td> <td>1.8</td> <td>0.5</td> <td>0.5</td> </tr> <tr> <td>GNM214</td> <td>0.6</td> <td>2.0</td> <td>0.25</td> <td>0.25</td> </tr> <tr> <td>GNM314</td> <td>0.8</td> <td>2.5</td> <td>0.4</td> <td>0.4</td> </tr> </tbody> </table> (in mm)	Type	a	b	c	d	GNM0M2	0.2	0.96	0.25	0.2	GNM1M2	0.5	1.6	0.32	0.32	GNM212	0.6	1.8	0.5	0.5	GNM214	0.6	2.0	0.25	0.25	GNM314	0.8	2.5	0.4	0.4
Type	a	b	c	d																													
GNM0M2	0.2	0.96	0.25	0.2																													
GNM1M2	0.5	1.6	0.32	0.32																													
GNM212	0.6	1.8	0.5	0.5																													
GNM214	0.6	2.0	0.25	0.25																													
GNM314	0.8	2.5	0.4	0.4																													
11	Vibration	Appearance: No defects or abnormalities Capacitance: Within the specified tolerance D.F.: 0.1 max.*3 *3 However 0.125 max. about Table 3 items.	Solder the capacitor to the test jig (glass epoxy board) in the same manner and under the same conditions as (10). The capacitor should be subjected to a simple harmonic motion having a total amplitude of 1.5mm, the frequency being varied uniformly between the approximate limits of 10 and 55Hz. The frequency range, from 10 to 55Hz and return to 10Hz, should be traversed in approximately 1 minute. This motion should be applied for a period of 2 hours in each of 3 mutually perpendicular directions (total of 6 hours).																														

Continued on the following page. 

GNM Series Specifications and Test Methods (2)

Continued from the preceding page.

In case Non "*" is added in PNs table, please refer to GNM Series Specifications and Test Methods (1).
 In case "*" is added in PNs table, please refer to GNM Series Specifications and Test Methods (2).

No.	Item	Specifications	Test Method																														
12	Appearance	No marking defects	Solder the capacitor to the test jig (glass epoxy board) shown in Fig. 2 using a eutectic solder. Then apply a force in the direction shown in Fig. 3. The soldering should be done by the reflow method and should be conducted with care so that the soldering is uniform and free of defects such as heat shock.																														
	Capacitance Change	Within ±10%																															
	Deflection	<div style="text-align: center;"> </div> <table border="1" style="margin: 10px auto; border-collapse: collapse;"> <thead> <tr> <th>Type</th> <th>a</th> <th>b</th> <th>c</th> <th>d</th> </tr> </thead> <tbody> <tr> <td>GNM0M2</td> <td>2.0±0.05</td> <td>0.2±0.05</td> <td>0.2±0.05</td> <td>0.25±0.05</td> </tr> <tr> <td>GNM1M2</td> <td>2.0±0.05</td> <td>0.5±0.05</td> <td>0.32±0.05</td> <td>0.32±0.05</td> </tr> <tr> <td>GNM212</td> <td>2.0±0.05</td> <td>0.6±0.05</td> <td>0.5±0.05</td> <td>0.5±0.05</td> </tr> <tr> <td>GNM214</td> <td>2.0±0.05</td> <td>0.7±0.05</td> <td>0.3±0.05</td> <td>0.2±0.05</td> </tr> <tr> <td>GNM314</td> <td>2.5±0.05</td> <td>0.8±0.05</td> <td>0.4±0.05</td> <td>0.4±0.05</td> </tr> </tbody> </table> <p style="text-align: center;">(in mm)</p> <p style="text-align: center;">Fig. 2</p>	Type	a	b	c	d	GNM0M2	2.0±0.05	0.2±0.05	0.2±0.05	0.25±0.05	GNM1M2	2.0±0.05	0.5±0.05	0.32±0.05	0.32±0.05	GNM212	2.0±0.05	0.6±0.05	0.5±0.05	0.5±0.05	GNM214	2.0±0.05	0.7±0.05	0.3±0.05	0.2±0.05	GNM314	2.5±0.05	0.8±0.05	0.4±0.05	0.4±0.05	<div style="text-align: center;"> </div> <p style="text-align: center;">Fig. 3</p>
Type	a	b	c	d																													
GNM0M2	2.0±0.05	0.2±0.05	0.2±0.05	0.25±0.05																													
GNM1M2	2.0±0.05	0.5±0.05	0.32±0.05	0.32±0.05																													
GNM212	2.0±0.05	0.6±0.05	0.5±0.05	0.5±0.05																													
GNM214	2.0±0.05	0.7±0.05	0.3±0.05	0.2±0.05																													
GNM314	2.5±0.05	0.8±0.05	0.4±0.05	0.4±0.05																													
13	Solderability of Termination	75% of the terminations are to be soldered evenly and continuously.	Immerse the capacitor in a solution of ethanol (JIS-K-8101) and rosin (JIS-K-5902) (25% rosin in weight proportion). Preheat at 80 to 120°C for 10 to 30 seconds. After preheating, immerse in eutectic solder solution for 2±0.5 seconds at 230±5°C or Sn-3.0Ag-0.5Cu solder solution for 2±0.5 seconds at 245±5°C.																														
14	Appearance	No marking defects	Preheat the capacitor at 120 to 150°C for 1 minute. Immerse the capacitor in a eutectic solder or Sn-3.0Ag-0.5Cu solder solution at 270±5°C for 10±0.5 seconds. Let sit at room temperature for 24±2 hours, then measure. • Initial measurement Perform a heat treatment at 150 +0/-10°C for one hour and then let sit for 24±2 hours at room temperature. Perform the initial measurement.																														
	Capacitance Change	R6 ⁴ : Within ±7.5% *4 GNM0M2R60E105: Within +15/-7.5%																															
	D.F.	0.1 max. *3 *3 However 0.125 max. about Table 3 items.																															
	I.R.	50Ω · F min.																															
	Dielectric Strength	No failure																															
15	Appearance	No marking defects	Fix the capacitor to the supporting jig in the same manner and under the same conditions as (10). Perform the five cycles according to the four heat treatments listed in the following table. Let sit for 24±2 hours at room temperature, then measure.																														
	Capacitance Change	R6 ⁵ : Within ±12.5% *5 GNM0M2R60E105: Within ±15%																															
	D.F.	0.1 max. *3 *3 However 0.125 max. about Table 3 items.																															
	I.R.	50Ω · F min.																															
	Dielectric Strength	No failure																															
	Temperature Cycle		<table border="1" style="margin: 10px auto; border-collapse: collapse;"> <thead> <tr> <th>Step</th> <th>1</th> <th>2</th> <th>3</th> <th>4</th> </tr> </thead> <tbody> <tr> <td>Temp. (°C)</td> <td>Min. Operating Temp.</td> <td>Room Temp.</td> <td>Min. Operating Temp.</td> <td>Room Temp.</td> </tr> <tr> <td>Time (min.)</td> <td>30±3</td> <td>2 to 3</td> <td>30±3</td> <td>2 to 3</td> </tr> </tbody> </table> • Initial measurement Perform a heat treatment at 150 +0/-10 °C for one hour and then let sit for 24±2 hours at room temperature. Perform the initial measurement.	Step	1	2	3	4	Temp. (°C)	Min. Operating Temp.	Room Temp.	Min. Operating Temp.	Room Temp.	Time (min.)	30±3	2 to 3	30±3	2 to 3															
Step	1	2	3	4																													
Temp. (°C)	Min. Operating Temp.	Room Temp.	Min. Operating Temp.	Room Temp.																													
Time (min.)	30±3	2 to 3	30±3	2 to 3																													
16	Appearance	No marking defects	Apply the rated voltage at 40±2°C and 90 to 95% humidity for 500±12 hours. The charge/discharge current is less than 50mA. • Initial measurement Perform a heat treatment at 150 +0/-10°C for one hour and then let sit for 24±2 hours at room temperature. Perform the initial measurement. • Measurement after test Perform a heat treatment at 150 +0/-10°C for one hour and then let sit for 24±2 hours at room temperature, then measure.																														
	Capacitance Change	R6: Within ±12.5%																															
	D.F.	0.2 max.																															
	I.R.	12.5Ω · F min.																															
17	Appearance	No marking defects	Apply 150% (GNM1M2R61A225/1C105: 125% of the rated voltage) of the rated voltage for 1000±12 hours at the maximum operating temperature ±3°C. Let sit for 24±2 hours at room temperature, then measure. The charge/discharge current is less than 50mA. • Initial measurement Perform a heat treatment at 150 +0/-10°C for one hour and then let sit for 24±2 hours at room temperature. Perform the initial measurement. • Measurement after test Perform a heat treatment at 150 +0/-10°C for one hour and then let sit for 24±2 hours at room temperature, then measure.																														
	Capacitance Change	R6: Within ±12.5%																															
	D.F.	0.2 max.																															
	I.R.	25Ω · F min.																															

2

Chip Monolithic Ceramic Capacitors



Low ESL LLL/LLA/LLM Series

3

Reversed Geometry Low ESL Type

■ Features

1. Low ESL, good for noise reduction for high frequency
2. Small, high cap

■ Applications

1. High speed micro processor
2. High frequency digital equipment

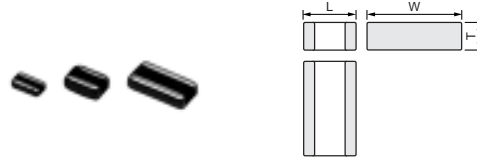

Part Number	Dimensions (mm)		
	L	W	T
LLL153	0.5 ±0.05	1.0 ±0.05	0.3 ±0.05
LLL185	0.8 ±0.1	1.6 ±0.1	0.6 max.
LLL215	1.25 ±0.1	2.0 ±0.1	0.5 +0/-0.15
LLL216			0.6 ±0.1
LLL219	1.6 ±0.15	3.2 ±0.15	0.85 ±0.1
LLL315			0.5 +0/-0.15
LLL317			0.7 ±0.1
LLL31M			1.15 ±0.1

Eight Terminals Low ESL Type

■ Features

1. Low ESL (100pH) , suitable to decoupling capacitor for 1GHz clock speed IC.
2. Small, large cap

■ Applications

1. High speed micro processor
2. High frequency digital equipment

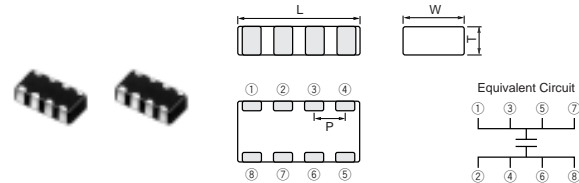

Part Number	Dimensions (mm)			
	L	W	T	P
LLA185	1.6 ±0.1	0.8 ±0.1	0.5 +0.05/-0.1	0.4 ±0.1
LLA215	2.0 ±0.1	1.25 ±0.1	0.5 +0.05/-0.1	0.5 ±0.05
LLA219	2.0 ±0.1	1.25 ±0.1	0.85 ±0.1	0.5 ±0.05
LLA315	3.2 ±0.15	1.6 ±0.15	0.5 +0.05/-0.1	0.8 ±0.1
LLA319	3.2 ±0.15	1.6 ±0.15	0.85 ±0.1	0.8 ±0.1
LLA31M	3.2 ±0.15	1.6 ±0.15	1.15 ±0.1	0.8 ±0.1

Ten Terminals Low ESL Type

■ Features

1. Low ESL (45pH), suitable to decoupling capacitor for 2GHz clock speed IC.
2. Small, large cap

■ Applications

1. High speed micro processor
2. High frequency digital equipment

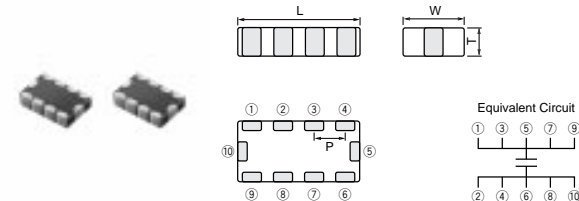

Part Number	Dimensions (mm)			
	L	W	T	P
LLM215	2.0 ±0.1	1.25 ±0.1	0.5 +0.05/-0.1	0.5 ±0.05
LLM315	3.2 ±0.15	1.6 ±0.15	0.5 +0.05/-0.1	0.8 ±0.1

Capacitance Table

Reversed Geometry Low ESL Type X7R(R7)/X7S(C7)/X6S(C8)/X5R(R6) Characteristics

5		ex.5: T Dimension [mm]																	
LxW [mm]	Rated Voltage [Vdc]	0.5x1.0 (15) <0204>				0.8x1.6 (18) <0306>				1.25x2.0 (21) <0508>				1.6x3.2 (31) <0612>					
		6.3 (0J)	4 (0G)	50 (1H)	25 (1E)	16 (1C)	10 (1A)	4 (0G)	50 (1H)	25 (1E)	16 (1C)	10 (1A)	4 (0G)	50 (1H)	25 (1E)	16 (1C)	10 (1A)	6.3 (0J)	
TC		X6S (C8)	X7S (C7)	X7R (R7)	X7R (R7)	X7R (R7)	X7R (R7)	X7S (C7)	X7R (R7)	X7R (R7)	X7R (R7)	X7R (R7)	X7S (C7)	X7R (R7)	X7R (R7)	X7R (R7)	X7R (R7)	X7R (R7)	X5R (R6)
2200pF(222)				5															
4700pF(472)				5															
10000pF(103)					5				6					7					
22000pF(223)					5				6					7					
47000pF(473)						5				6				7					
0.10μF(104)	3						5			6				M	7				
0.22μF(224)	3						5				9	6			M	7			
0.47μF(474)		3						5				9			M	7			
1.0μF(105)								5				9				M	7		
2.2μF(225)								5					9				M	7	
4.7μF(475)																		M	7
10μF(106)																			M

The part number code is shown in () and Unit is shown in []. <->: EIA [inch] Code

Reversed Geometry Low ESL Type X7R(R7)/X7S(C7) Characteristics Low Profile

5		ex.5: T Dimension [mm]												
LxW [mm]	Rated Voltage [Vdc]	0.8x1.6 (18) <0306>				1.25x2.0 (21) <0508>				1.6x3.2 (31) <0612>				
		25 (1E)	16 (1C)	10 (1A)	4 (0G)	50 (1H)	25 (1E)	16 (1C)	10 (1A)	6.3 (0J)	4 (0G)	50 (1H)	25 (1E)	16 (1C)
TC		X7R (R7)	X7R (R7)	X7R (R7)	X7S (C7)	X7R (R7)	X7R (R7)	X7R (R7)	X7R (R7)	X7S (C7)	X7R (R7)	X7R (R7)	X7R (R7)	X7R (R7)
10000pF(103)		5				5						5		
22000pF(223)			5				5					5		
47000pF(473)			5					5					5	
0.10μF(104)				5				5					5	
0.22μF(224)					5				5					5
0.47μF(474)										5				
1.0μF(105)											5			

The part number code is shown in () and Unit is shown in []. <->: EIA [inch] Code

Continued on the following page. ↗

3

Capacitance Table

Continued from the preceding page.

Eight Terminals Low ESL Type X7S(C7)/X7R(R7) Characteristics

		ex.5: T Dimension [mm]								
		2.0x1.25 (21) <0805>					3.2x1.6 (31) <1206>			
LxW [mm]		2.0x1.25 (21) <0805>					3.2x1.6 (31) <1206>			
Rated Voltage [Vdc]		4 (0G)	25 (1E)	16 (1C)	10 (1A)	6.3 (0J)	4 (0G)	16 (1C)	10 (1A)	4 (0G)
TC		X7S (C7)	X7R (R7)	X7R (R7)	X7R (R7)	X7R (R7)	X7S (C7)	X7R (R7)	X7R (R7)	X7R (R7)
Capacitance										
10000pF(103)			9							
22000pF(223)			9							
47000pF(473)			9							
0.10μF(104)		5		9				9		
0.22μF(224)		5		9				9		
0.47μF(474)		5			9			9		
1.0μF(105)		5				9		M	9	
2.2μF(225)		5					9		M	9
4.7μF(475)							9			

The part number code is shown in () and Unit is shown in []. <->: EIA [inch] Code

Eight Terminals Low ESL Type X7R(R7)/X7S(C7) Characteristics Low Profile

		ex.5: T Dimension [mm]							
		2.0x1.25 (21) <0805>					3.2x1.6 (31) <1206>		
LxW [mm]		2.0x1.25 (21) <0805>					3.2x1.6 (31) <1206>		
Rated Voltage [Vdc]		25 (1E)	16 (1C)	10 (1A)	6.3 (0J)	4 (0G)	16 (1C)	10 (1A)	6.3 (0J)
TC		X7R (R7)	X7R (R7)	X7R (R7)	X7R (R7)	X7S (C7)	X7R (R7)	X7R (R7)	X7R (R7)
Capacitance									
10000pF(103)		5							
22000pF(223)		5							
47000pF(473)			5						
0.10μF(104)			5						
0.22μF(224)				5			5		
0.47μF(474)					5			5	
1.0μF(105)						5			5
2.2μF(225)							5		5
4.7μF(475)							5		

The part number code is shown in () and Unit is shown in []. <->: EIA [inch] Code

Ten Terminals Low ESL Type X7R(R7)/X7S(C7) Characteristics Low Profile

		ex.5: T Dimension [mm]							
		2.0x1.25 (21) <0805>					3.2x1.6 (31) <1206>		
LxW [mm]		2.0x1.25 (21) <0805>					3.2x1.6 (31) <1206>		
Rated Voltage [Vdc]		25 (1E)	16 (1C)	6.3 (0J)	4 (0G)	16 (1C)	10 (1A)	6.3 (0J)	
TC		X7R (R7)	X7R (R7)	X7R (R7)	X7S (C7)	X7R (R7)	X7R (R7)	X7R (R7)	
Capacitance									
10000pF(103)		5							
22000pF(223)		5							
47000pF(473)			5						
0.10μF(104)			5			5			
0.22μF(224)				5		5			
0.47μF(474)					5		5		
1.0μF(105)						5			
2.2μF(225)								5	

The part number code is shown in () and Unit is shown in []. <->: EIA [inch] Code

Reversed Geometry Low ESL Type X7R(R)/X7S(C7)/X6S(C8) Characteristics

LxW [mm]		0.5x1.0(15)<0204>	
Rated Volt. [Vdc]		6.3(0J)	4(0G)
Capacitance	Tolerance	Part Number	
0.10μF(104)	±20%(M)	LLL153C80J104ME01E*	
0.22μF(224)	±20%(M)	LLL153C80J224ME14E*	
0.47μF(474)	±20%(M)	LLL153C70G474ME17E*	

LLL153 Series 4V/0.47μF(L: 0.5+0.07/-0.03mm)

LxW [mm]		0.8x1.6(18)<0306>			
Rated Volt. [Vdc]		50(1H)	25(1E)	16(1C)	10(1A)
Capacitance	Tolerance	Part Number			
2200pF(222)	±20%(M)	LLL185R71H222MA01L			
4700pF(472)	±20%(M)	LLL185R71H472MA01L			
10000pF(103)	±20%(M)	LLL185R71E103MA01L			
22000pF(223)	±20%(M)	LLL185R71E223MA01L			
47000pF(473)	±20%(M)	LLL185R71C473MA01L			
0.10μF(104)	±20%(M)	LLL185R71A104MA01L			
0.22μF(224)	±20%(M)	LLL185R71A224MA01L			

LxW [mm]		0.8x1.6(18)<0306>	
Rated Volt. [Vdc]		4(0G)	
Capacitance	Tolerance	Part Number	
0.47μF(474)	±20%(M)	LLL185C70G474MA01L	
1.0μF(105)	±20%(M)	LLL185C70G105ME02L*	
2.2μF(225)	±20%(M)	LLL185C70G225ME01L*	

LxW [mm]		1.25x2.0(21)<0508>			
Rated Volt. [Vdc]		50(1H)	25(1E)	16(1C)	10(1A)
Capacitance	Tolerance	Part Number			
10000pF(103)	±20%(M)	LLL216R71H103MA01L			
22000pF(223)	±20%(M)	LLL216R71H223MA01L			
47000pF(473)	±20%(M)	LLL216R71E473MA01L			
0.10μF(104)	±20%(M)	LLL216R71E104MA01L			
0.22μF(224)	±20%(M)	LLL219R71C224MA01L			
0.47μF(474)	±20%(M)	LLL219R71A474MA01L			
1.0μF(105)	±20%(M)	LLL219R71A105MA01L			

LxW [mm]		1.25x2.0(21)<0508>	
Rated Volt. [Vdc]		4(0G)	
Capacitance	Tolerance	Part Number	
2.2μF(225)	±20%(M)	LLL219C70G225MA01L	

The part number code is shown in () and Unit is shown in []. <->: EIA [inch] Code

*: Please refer to LLL/LLA/LLM Series Specifications and Test Method(2).

(Part Number) **LL** **L** **15** **3** **C8** **0J** **104** **M** **E01** **E**
 ① ② ③ ④ ⑤ ⑥ ⑦ ⑧ ⑨ ⑩

① Product ID ② Series
 ⑤ Temperature Characteristics
 ⑥ Capacitance Tolerance

③ Dimension (LxW)
 ⑥ Rated Voltage
 ⑨ Individual Specification Code

④ Dimension (T)
 ⑦ Capacitance
 ⑩ Packaging

Packaging Code in Part Number is a code shows STD 180mm Reel Taping.

Reversed Geometry Low ESL Type X7R(R7)/X5R(R6) Characteristics

LxW [mm]		1.6x3.2(31)<0612>			
Rated Volt. [Vdc]		50(1H)	25(1E)	16(1C)	10(1A)
Capacitance	Tolerance	Part Number			
10000pF(103)	±20%(M)	LLL317R71H103MA01L			
22000pF(223)	±20%(M)	LLL317R71H223MA01L			
47000pF(473)	±20%(M)	LLL317R71H473MA01L			
0.10μF(104)	±20%(M)	LLL31MR71H104MA01L	LLL317R71E104MA01L		
0.22μF(224)	±20%(M)		LLL31MR71E224MA01L	LLL317R71C224MA01L	
0.47μF(474)	±20%(M)		LLL31MR71E474MA01L	LLL317R71C474MA01L	
1.0μF(105)	±20%(M)			LLL31MR71C105MA01L	LLL317R71A105MA01L
2.2μF(225)	±20%(M)				LLL31MR71A225MA01L

LxW [mm]		1.6x3.2(31)<0612>	
Rated Volt. [Vdc]		6.3(0J)	
Capacitance	Tolerance	Part Number	
2.2μF(225)	±20%(M)	LLL317R70J225MA01L	
4.7μF(475)	±20%(M)	LLL31MR70J475MA01L	
10μF(106)	±20%(M)	LLL31MR60J106ME01L*	

The part number code is shown in () and Unit is shown in []. < >: EIA [inch] Code
 *: Please refer to LLL/LLA/LLM Series Specifications and Test Method(2).

Reversed Geometry Low ESL Type X7R(R7)/X7S(C7) Characteristics Low Profile

LxW [mm]		0.8x1.6(18)<0306>			
Rated Volt. [Vdc]		25(1E)	16(1C)	10(1A)	4(0G)
Capacitance	Tolerance	Part Number			
10000pF(103)	±20%(M)	LLL185R71E103MA11L			
22000pF(223)	±20%(M)		LLL185R71C223MA11L		
47000pF(473)	±20%(M)		LLL185R71C473MA11L		
0.10μF(104)	±20%(M)			LLL185R71A104MA11L	
0.22μF(224)	±20%(M)				LLL185C70G224MA11L

LxW [mm]		1.25x2.0(21)<0508>			
Rated Volt. [Vdc]		50(1H)	25(1E)	16(1C)	10(1A)
Capacitance	Tolerance	Part Number			
10000pF(103)	±20%(M)	LLL215R71H103MA11L			
22000pF(223)	±20%(M)		LLL215R71E223MA11L		
47000pF(473)	±20%(M)			LLL215R71C473MA11L	
0.10μF(104)	±20%(M)			LLL215R71C104MA11L	
0.22μF(224)	±20%(M)				LLL215R71A224MA11L

LxW [mm]		1.25x2.0(21)<0508>	
Rated Volt. [Vdc]		6.3(0J)	4(0G)
Capacitance	Tolerance	Part Number	
0.47μF(474)	±20%(M)	LLL215R70J474MA11L	
1.0μF(105)	±20%(M)	LLL215C70G105MA11L	

The part number code is shown in () and Unit is shown in []. < >: EIA [inch] Code
 *: Please refer to LLL/LLA/LLM Series Specifications and Test Method(2).

(Part Number) **LL** **L** **31** **7** **R7** **1H** **103** **M** **A01** **L**
 ① ② ③ ④ ⑤ ⑥ ⑦ ⑧ ⑨ ⑩

- ① Product ID
- ② Series
- ③ Dimension (LxW)
- ④ Dimension (T)
- ⑤ Temperature Characteristics
- ⑥ Rated Voltage
- ⑦ Capacitance
- ⑧ Capacitance Tolerance
- ⑨ Individual Specification Code
- ⑩ Packaging

Packaging Code in Part Number is a code shows STD 180mm Reel Taping.

Reversed Geometry Low ESL Type X7R(R7) Characteristics Low Profile

LxW [mm]		1.6x3.2(31)<0612>			
Rated Volt. [Vdc]		50(1H)	25(1E)	16(1C)	10(1A)
Capacitance	Tolerance	Part Number			
10000pF(103)	±20%(M)	LLL315R71H103MA11L			
22000pF(223)	±20%(M)	LLL315R71H223MA11L			
47000pF(473)	±20%(M)		LLL315R71E473MA11L		
0.10μF(104)	±20%(M)		LLL315R71E104MA11L		
0.22μF(224)	±20%(M)			LLL315R71C224MA11L	
0.47μF(474)	±20%(M)				LLL315R71A474MA11L

The part number code is shown in () and Unit is shown in []. < >: EIA [inch] Code
 *: Please refer to LLL/LLA/LLM Series Specifications and Test Method(2).

3

Eight Terminals Low ESL Type X7R(R7)/X7S(C7) Characteristics

LxW [mm]		1.6x0.8(18)<0603>	
Rated Volt. [Vdc]		4(0G)	
Capacitance	Tolerance	Part Number	
0.10μF(104)	±20%(M)	LLA185C70G104MA01L	
0.22μF(224)	±20%(M)	LLA185C70G224MA01L	
0.47μF(474)	±20%(M)	LLA185C70G474MA01L	
1.0μF(105)	±20%(M)	LLA185C70G105ME01L*	
2.2μF(225)	±20%(M)	LLA185C70G225ME16L*	

LxW [mm]		2.0x1.25(21)<0805>			
Rated Volt. [Vdc]		25(1E)	16(1C)	10(1A)	6.3(0J)
Capacitance	Tolerance	Part Number			
10000pF(103)	±20%(M)	LLA219R71E103MA01L			
22000pF(223)	±20%(M)	LLA219R71E223MA01L			
47000pF(473)	±20%(M)	LLA219R71E473MA01L			
0.10μF(104)	±20%(M)		LLA219R71C104MA01L		
0.22μF(224)	±20%(M)		LLA219R71C224MA01L		
0.47μF(474)	±20%(M)			LLA219R71A474MA01L	
1.0μF(105)	±20%(M)				LLA219R70J105MA01L

LxW [mm]		2.0x1.25(21)<0805>	
Rated Volt. [Vdc]		4(0G)	
Capacitance	Tolerance	Part Number	
2.2μF(225)	±20%(M)	LLA219C70G225MA01L	
4.7μF(475)	±20%(M)	LLA219C70G475ME01L*	

LxW [mm]		3.2x1.6(31)<1206>		
Rated Volt. [Vdc]		16(1C)	10(1A)	4(0G)
Capacitance	Tolerance	Part Number		
0.10μF(104)	±20%(M)	LLA319R71C104MA01L		
0.22μF(224)	±20%(M)	LLA319R71C224MA01L		
0.47μF(474)	±20%(M)	LLA319R71C474MA01L		
1.0μF(105)	±20%(M)	LLA31MR71C105MA01L	LLA319R71A105MA01L	
2.2μF(225)	±20%(M)	LLA31MR71A225MA01L	LLA319R70G225MA01L	

The part number code is shown in () and Unit is shown in []. < >: EIA [inch] Code
 *: Please refer to LLL/LLA/LLM Series Specifications and Test Method(2).

Eight Terminals Low ESL Type X7R(R7)/X7S(C7) Characteristics Low Profile

LxW [mm]		2.0x1.25(21)<0805>			
Rated Volt. [Vdc]		25(1E)	16(1C)	10(1A)	6.3(0J)
Capacitance	Tolerance	Part Number			
10000pF(103)	±20%(M)	LLA215R71E103MA14L			
22000pF(223)	±20%(M)	LLA215R71E223MA14L			
47000pF(473)	±20%(M)		LLA215R71C473MA14L		
0.10μF(104)	±20%(M)		LLA215R71C104MA14L		
0.22μF(224)	±20%(M)			LLA215R71A224MA14L	
0.47μF(474)	±20%(M)				LLA215R70J474MA14L

LxW [mm]		2.0x1.25(21)<0805>	
Rated Volt. [Vdc]		4(0G)	
Capacitance	Tolerance	Part Number	
1.0μF(105)	±20%(M)	LLA215C70G105MA14L	
2.2μF(225)	±20%(M)	LLA215C70G225ME11L*	
4.7μF(475)	±20%(M)	LLA215C70G475ME19L*	

LxW [mm]		3.2x1.6(31)<1206>		
Rated Volt. [Vdc]		16(1C)	10(1A)	6.3(0J)
Capacitance	Tolerance	Part Number		
0.22μF(224)	±20%(M)	LLA315R71C224MA14L		
0.47μF(474)	±20%(M)		LLA315R71A474MA14L	
1.0μF(105)	±20%(M)			LLA315R70J105MA14L
2.2μF(225)	±20%(M)			LLA315R70J225MA14L

The part number code is shown in () and Unit is shown in []. < >: EIA [inch] Code
 *: Please refer to LLL/LLA/LLM Series Specifications and Test Method(2).

Ten Terminals Low ESL Type X7R(R7)/X7S(C7) Characteristics Low Profile

LxW [mm]		2.0x1.25(21)<0805>			
Rated Volt. [Vdc]		25(1E)	16(1C)	6.3(0J)	4(0G)
Capacitance	Tolerance	Part Number			
10000pF(103)	±20%(M)	LLM215R71E103MA11L			
22000pF(223)	±20%(M)	LLM215R71E223MA11L			
47000pF(473)	±20%(M)		LLM215R71C473MA11L		
0.10μF(104)	±20%(M)		LLM215R71C104MA11L		
0.22μF(224)	±20%(M)			LLM215R70J224MA11L	
0.47μF(474)	±20%(M)			LLM215R70J474MA11L	
1.0μF(105)	±20%(M)				LLM215C70G105MA11L
2.2μF(225)	±20%(M)				LLM215C70G225ME11L*

LxW [mm]		3.2x1.6(31)<1206>		
Rated Volt. [Vdc]		16(1C)	10(1A)	6.3(0J)
Capacitance	Tolerance	Part Number		
0.10μF(104)	±20%(M)	LLM315R71C104MA11L		
0.22μF(224)	±20%(M)	LLM315R71C224MA11L		
0.47μF(474)	±20%(M)		LLM315R71A474MA11L	
2.2μF(225)	±20%(M)			LLM315R70J225MA11L

The part number code is shown in () and Unit is shown in []. < >: EIA [inch] Code
 *: Please refer to LLL/LLA/LLM Series Specifications and Test Method(2).

(Part Number) **LL** **A** **21** **5** **R7** **1E** **103** **M** **A14** **L**
 ① ② ③ ④ ⑤ ⑥ ⑦ ⑧ ⑨ ⑩

① Product ID ② Series
 ③ Dimension (LxW) ④ Dimension (T)
 ⑤ Temperature Characteristics ⑥ Rated Voltage ⑦ Capacitance
 ⑧ Capacitance Tolerance ⑨ Individual Specification Code ⑩ Packaging

Packaging Code in Part Number is a code shows STD 180mm Reel Taping.

LLL/LLA/LLM Series Specifications and Test Methods (1)

In case Non "***" is added in PNs table, please refer to LLL/LLA/LLM Series Specifications and Test Methods (1).
 In case "*" is added in PNs table, please refer to LLL/LLA/LLM Series Specifications and Test Methods (2).

No.	Item	Specifications	Test Method																								
1	Operating Temperature Range	R7, C7: -55 to +125°C																									
2	Rated Voltage	See the previous pages.	The rated voltage is defined as the maximum voltage which may be applied continuously to the capacitor. When AC voltage is superimposed on DC voltage, V ^{P-P} or V ^{O-P} , whichever is larger, should be maintained within the rated voltage range.																								
3	Appearance	No defects or abnormalities	Visual inspection																								
4	Dimensions	Within the specified dimension	Using calipers																								
5	Dielectric Strength	No defects or abnormalities	No failure should be observed when 250% of the rated voltage is applied between the terminations for 1 to 5 seconds, provided the charge/discharge current is less than 50mA.																								
6	Insulation Resistance	C ≤ 0.047μF: More than 10,000MΩ C > 0.047μF: More than 500Ω · F C: Normal Capacitance	The insulation resistance should be measured with a DC voltage not exceeding the rated voltage at 25°C and 75%RH max. and within 2 minutes of charging.																								
7	Capacitance	Within the specified tolerance	The capacitance/D.F. should be measured at 25°C at the frequency and voltage shown in the table. Frequency: 1±0.1kHz Voltage: 1±0.2Vrms *For LLA185C70G474, the capacitance should be measured using a voltage of 0.5±0.1Vrms.																								
8	Dissipation Factor (D.F.)	W.V.: 25V min.; 0.025 max. W.V.: 16V/10V max.; 0.035 max. W.V.: 6.3V max.; 0.05 max.																									
9	Capacitance Temperature Characteristics	<table border="1" style="margin: 10px auto; border-collapse: collapse;"> <thead> <tr> <th>Char.</th> <th>Temp. Range (°C)</th> <th>Reference Temp.</th> <th>Cap.Change</th> </tr> </thead> <tbody> <tr> <td>R7</td> <td>-55 to +125</td> <td>25°C</td> <td>Within ±15%</td> </tr> <tr> <td>C7</td> <td>-55 to +125</td> <td>25°C</td> <td>Within ±22%</td> </tr> </tbody> </table>	Char.	Temp. Range (°C)	Reference Temp.	Cap.Change	R7	-55 to +125	25°C	Within ±15%	C7	-55 to +125	25°C	Within ±22%	<p>The capacitance change should be measured after 5 min. at each specified temperature stage.</p> <table border="1" style="margin: 10px auto; border-collapse: collapse;"> <thead> <tr> <th>Step</th> <th>Temperature (°C)</th> </tr> </thead> <tbody> <tr> <td>1</td> <td>25±2</td> </tr> <tr> <td>2</td> <td>-55±3</td> </tr> <tr> <td>3</td> <td>25±2</td> </tr> <tr> <td>4</td> <td>125±3</td> </tr> <tr> <td>5</td> <td>25±2</td> </tr> </tbody> </table> <p>The ranges of capacitance change compared with the 25°C value over the temperature ranges shown in the table should be within the specified ranges. • Initial measurement. Perform a heat treatment at 150±0/-10°C for one hour and then set for 24±2 hours at room temperature. Perform the initial measurement.</p>	Step	Temperature (°C)	1	25±2	2	-55±3	3	25±2	4	125±3	5	25±2
Char.	Temp. Range (°C)	Reference Temp.	Cap.Change																								
R7	-55 to +125	25°C	Within ±15%																								
C7	-55 to +125	25°C	Within ±22%																								
Step	Temperature (°C)																										
1	25±2																										
2	-55±3																										
3	25±2																										
4	125±3																										
5	25±2																										
10	Adhesive Strength of Termination	No removal of the terminations or other defect should occur.	Solder the capacitor to the test jig (glass epoxy board) using a eutectic solder. Then apply 10N* force in parallel with the test jig for 10±1 sec. The soldering should be done either with an iron or using the reflow method and should be conducted with care so that the soldering is uniform and free of defects such as heat shock. *LLL18 and LLA/LLM Series: 5N																								
11	Vibration Resistance	Appearance	No defects or abnormalities																								
		Capacitance	Within the specified tolerance																								
		D.F.	W.V.: 25V min.; 0.025 max. W.V.: 16V/10V max.; 0.035 max. W.V.: 6.3V max.; 0.05 max.																								
12	Solderability of Termination	75% of the terminations are to be soldered evenly and continuously.	Immerse the capacitor in a solution of ethanol (JIS-K-8101) and rosin (JIS-K-5902) (25% rosin in weight proportion). Preheat at 80 to 120°C for 10 to 30 seconds. After preheating, immerse in eutectic solder solution for 2±0.5 seconds at 230±5°C, or Sn-3.0Ag-0.5Cu solder solution for 2±0.5 seconds at 245±5°C.																								
13	Resistance to Soldering Heat	Appearance	No marking defects																								
		Capacitance Change	Within ±7.5%																								
		D.F.	W.V.: 25V min.; 0.025 max. W.V.: 16V/10V max.; 0.035 max. W.V.: 6.3V max.; 0.05 max.																								
		I.R.	More than 10,000MΩ or 500Ω · F (Whichever is smaller)																								
		Dielectric Strength	No failure																								

3

Continued on the following page.

LLL/LLA/LLM Series Specifications and Test Methods (1)

Continued from the preceding page. In case Non "***" is added in PNs table, please refer to LLL/LLA/LLM Series Specifications and Test Methods (1).
 In case "***" is added in PNs table, please refer to LLL/LLA/LLM Series Specifications and Test Methods (2).

No.	Item	Specifications	Test Method															
14	Temperature Cycle	Appearance	Fix the capacitor to the supporting jig in the same manner and under the same conditions as (10). Perform the five cycles according to the four heat treatments listed in the following table. Let sit for 24±2 hours at room temperature, then measure. <table border="1" style="margin: 10px 0;"> <thead> <tr> <th>Step</th> <th>1</th> <th>2</th> <th>3</th> <th>4</th> </tr> </thead> <tbody> <tr> <td>Temp. (°C)</td> <td>Min. Operating Temp. $\pm 3^{\circ}$</td> <td>Room Temp.</td> <td>Max. Operating Temp. $\pm 3^{\circ}$</td> <td>Room Temp.</td> </tr> <tr> <td>Time (min.)</td> <td>30±3</td> <td>2 to 3</td> <td>30±3</td> <td>2 to 3</td> </tr> </tbody> </table> <ul style="list-style-type: none"> • Initial measurement. Perform a heat treatment at 150±5 °C for one hour and then let sit for 24±2 hours at room temperature. Perform the initial measurement. 	Step	1	2	3	4	Temp. (°C)	Min. Operating Temp. $\pm 3^{\circ}$	Room Temp.	Max. Operating Temp. $\pm 3^{\circ}$	Room Temp.	Time (min.)	30±3	2 to 3	30±3	2 to 3
		Step		1	2	3	4											
		Temp. (°C)		Min. Operating Temp. $\pm 3^{\circ}$	Room Temp.	Max. Operating Temp. $\pm 3^{\circ}$	Room Temp.											
		Time (min.)		30±3	2 to 3	30±3	2 to 3											
		Capacitance Change		Within ±7.5%														
D.F.	W.V.: 25V min.; 0.025 max. W.V.: 16V/10V max.; 0.035 max. W.V.: 6.3V max.; 0.05 max.																	
I.R.	More than 10,000MΩ or 500Ω · F (Whichever is smaller)																	
Dielectric Strength	No failure																	
15	Humidity (Steady State)	Appearance	Sit the capacitor at 40±2°C and 90 to 95% humidity for 500±12 hours. Remove and let sit for 24±2 hours at room temperature, then measure.															
		Capacitance Change		Within ±12.5%														
		D.F.		W.V.: 10V min.; 0.05 max. W.V.: 6.3V max.; 0.075 max.														
		I.R.		More than 1,000MΩ or 50Ω · F (Whichever is smaller)														
16	Humidity Load	Appearance	Apply the rated voltage at 40±2°C and 90 to 95% humidity for 500±12 hours. Remove and let sit for 24±2 hours at room temperature, then measure. The charge/discharge current is less than 50mA.															
		Capacitance Change		Within ±12.5%														
		D.F.		W.V.: 10V min.; 0.05 max. W.V.: 6.3V max.; 0.075 max.														
		I.R.		More than 500MΩ or 25Ω · F (Whichever is smaller)														
17	High Temperature Load	Appearance	Apply 200% of the rated voltage for 1000±12 hours at the maximum operating temperature ±3°C. Let sit for 24±2 hours at room temperature, then measure. The charge/discharge current is less than 50mA. <ul style="list-style-type: none"> • Initial measurement. Apply 200% of the rated DC voltage for one hour at the maximum operating temperature ±3°C. Remove and let sit for 24±2 hours at room temperature. Perform initial measurement. 															
		Capacitance Change		Within ±12.5%														
		D.F.		W.V.: 10V min.; 0.05 max. W.V.: 6.3V max.; 0.075 max.														
		I.R.		More than 1,000MΩ or 50Ω · F (Whichever is smaller)														

LLL/LLA/LLM Series Specifications and Test Methods (2)

In case Non "*" is added in PNs table, please refer to LLL/LLA/LLM Series Specifications and Test Methods (1).
 In case "*" is added in PNs table, please refer to LLL/LLA/LLM Series Specifications and Test Methods (2).

No.	Item	Specifications	Test Method																	
1	Operating Temperature Range	R6: -55 to +85°C R7, C7: -55 to +125°C C8: -55 to +105°C																		
2	Rated Voltage	See the previous pages.	The rated voltage is defined as the maximum voltage which may be applied continuously to the capacitor. When AC voltage is superimposed on DC voltage, V ^{P-P} or V _{0-P} , whichever is larger, should be maintained within the rated voltage range.																	
3	Appearance	No defects or abnormalities	Visual inspection																	
4	Dimensions	Within the specified dimension	Using calipers																	
5	Dielectric Strength	No defects or abnormalities	No failure should be observed when 250% of the rated voltage is applied between the terminations for 1 to 5 seconds, provided the charge/discharge current is less than 50mA.																	
6	Insulation Resistance	50Ω · F min.	The insulation resistance should be measured with a DC voltage not exceeding the rated voltage at 25°C and 75%RH max. and within 1 minute of charging.																	
7	Capacitance	Within the specified tolerance	The capacitance/D.F. should be measured at 25°C at the frequency and voltage shown in the table.																	
8	Dissipation Factor (D.F.)	R6, R7, C7, C8: 0.120 max.	<table border="1" style="margin-left: auto; margin-right: auto;"> <thead> <tr> <th>Capacitance</th> <th>Frequency</th> <th>Voltage</th> </tr> </thead> <tbody> <tr> <td>C ≤ 10μF (10V min.)</td> <td>1±0.1kHz</td> <td>1.0±0.2Vrms</td> </tr> <tr> <td>C ≤ 10μF (6.3V max.)</td> <td>1±0.1kHz</td> <td>0.5±0.1Vrms</td> </tr> <tr> <td>C > 10μF</td> <td>120±24Hz</td> <td>0.5±0.1Vrms</td> </tr> </tbody> </table>	Capacitance	Frequency	Voltage	C ≤ 10μF (10V min.)	1±0.1kHz	1.0±0.2Vrms	C ≤ 10μF (6.3V max.)	1±0.1kHz	0.5±0.1Vrms	C > 10μF	120±24Hz	0.5±0.1Vrms					
Capacitance	Frequency	Voltage																		
C ≤ 10μF (10V min.)	1±0.1kHz	1.0±0.2Vrms																		
C ≤ 10μF (6.3V max.)	1±0.1kHz	0.5±0.1Vrms																		
C > 10μF	120±24Hz	0.5±0.1Vrms																		
9	Capacitance Temperature Characteristics	<table border="1" style="margin-left: auto; margin-right: auto;"> <thead> <tr> <th>Char.</th> <th>Temp. Range (°C)</th> <th>Reference Temp.</th> <th>Cap. Change</th> </tr> </thead> <tbody> <tr> <td>R6</td> <td>-55 to +85</td> <td rowspan="4" style="text-align: center;">25°C</td> <td>Within ±15%</td> </tr> <tr> <td>R7</td> <td>-55 to +125</td> <td>Within ±15%</td> </tr> <tr> <td>C7</td> <td>-55 to +125</td> <td>Within ±22%</td> </tr> <tr> <td>C8</td> <td>-55 to +105</td> <td>Within ±22%</td> </tr> </tbody> </table>	Char.	Temp. Range (°C)	Reference Temp.	Cap. Change	R6	-55 to +85	25°C	Within ±15%	R7	-55 to +125	Within ±15%	C7	-55 to +125	Within ±22%	C8	-55 to +105	Within ±22%	<p>The capacitance change should be measured after 5 min. at each specified temperature stage.</p> <p>The ranges of capacitance change compared with the 25°C value over the temperature ranges shown in the table should be within the specified ranges.</p> <p>• Initial measurement. Perform a heat treatment at 150±0/-10°C for one hour and then set for 24±2 hours at room temperature. Perform the initial measurement.</p>
Char.	Temp. Range (°C)	Reference Temp.	Cap. Change																	
R6	-55 to +85	25°C	Within ±15%																	
R7	-55 to +125		Within ±15%																	
C7	-55 to +125		Within ±22%																	
C8	-55 to +105		Within ±22%																	
10	Adhesive Strength of Termination	No removal of the terminations or other defect should occur.	Solder the capacitor to the test jig (glass epoxy board) using a eutectic solder. Then apply 10N* force in parallel with the test jig for 10±1 sec. The soldering should be done either with an iron or using the reflow method and should be conducted with care so that the soldering is uniform and free of defects such as heat shock. *5N (LLL15, LLL18, LLA, LLM Series)																	
11	Vibration	Appearance	Solder the capacitor to the test jig (glass epoxy board) in the same manner and under the same conditions as (10). The capacitor should be subjected to a simple harmonic motion having a total amplitude of 1.5mm, the frequency being varied uniformly between the approximate limits of 10 and 55Hz. The frequency range, from 10 to 55Hz and return to 10Hz, should be traversed in approximately 1 minute. This motion should be applied for a period of 2 hours in each of 3 mutually perpendicular directions (total of 6 hours).																	
		Capacitance																		
		D.F.																		
12	Solderability of Termination	75% of the terminations are to be soldered evenly and continuously.	Immerse the capacitor in a solution of ethanol (JIS-K-8101) and rosin (JIS-K-5902) (25% rosin in weight proportion). Preheat at 80 to 120°C for 10 to 30 seconds. After preheating, immerse in eutectic solder solution for 2±0.5 seconds at 230±5°C, or Sn-3.0Ag-0.5Cu solder solution for 2±0.5 seconds at 245±5°C.																	
13	Resistance to Soldering Heat	Appearance	Preheat the capacitor at 120 to 150°C for 1 minute. Immerse the capacitor in a eutectic solder or Sn-3.0Ag-0.5Cu solder solution at 270±5°C for 10±0.5 seconds. Let sit at room temperature for 24±2 hours, then measure.																	
		Capacitance Change																		
		D.F.																		
		I.R.																		
		Dielectric Strength																		

Continued on the following page.

3

LLL/LLA/LLM Series Specifications and Test Methods (2)

Continued from the preceding page.

In case Non "*" is added in PNs table, please refer to LLL/LLA/LLM Series Specifications and Test Methods (1).
 In case "*" is added in PNs table, please refer to LLL/LLA/LLM Series Specifications and Test Methods (2).

No.	Item	Specifications	Test Method															
14	Temperature Sudden Change	Appearance	Fix the capacitor to the supporting jig in the same manner and under the same conditions as (10). Perform the five cycles according to the four heat treatments listed in the following table. Let sit for 24±2 hours at room temperature, then measure. <table border="1" style="margin-top: 10px;"> <thead> <tr> <th>Step</th> <th>1</th> <th>2</th> <th>3</th> <th>4</th> </tr> </thead> <tbody> <tr> <td>Temp. (°C)</td> <td>Min. Operating Temp. ±3</td> <td>Room Temp.</td> <td>Min. Operating Temp. ±3</td> <td>Room Temp.</td> </tr> <tr> <td>Time (min.)</td> <td>30±3</td> <td>2 to 3</td> <td>30±3</td> <td>2 to 3</td> </tr> </tbody> </table>	Step	1	2	3	4	Temp. (°C)	Min. Operating Temp. ±3	Room Temp.	Min. Operating Temp. ±3	Room Temp.	Time (min.)	30±3	2 to 3	30±3	2 to 3
		Step		1	2	3	4											
		Temp. (°C)		Min. Operating Temp. ±3	Room Temp.	Min. Operating Temp. ±3	Room Temp.											
		Time (min.)		30±3	2 to 3	30±3	2 to 3											
		Capacitance Change		R6, R7, C7, C8: Within ±12.5%														
D.F.	R6, R7, C7, C8: 0.120 max.																	
I.R.	50Ω · F min.																	
Dielectric Strength	No failure																	
15	High Temperature High Humidity (Steady State)	Appearance	Apply the rated voltage at 40±2°C and 90 to 95% humidity for 500±12 hours. The charge/discharge current is less than 50mA. Apply the rated DC voltage. <ul style="list-style-type: none"> •Initial measurement Perform a heat treatment at 150±9₀°C for one hour and then let sit for 24±2 hours at room temperature. Perform the initial measurement. •Measurement after test Perform a heat treatment at 150±9₀°C for one hour and then let sit for 24±2 hours at room temperature, then measure. 															
		Capacitance Change		R6, R7, C7, C8: Within ±12.5%														
		D.F.		R6, R7, C7, C8: 0.2 max.														
		I.R.		12.5Ω · F min.														
16	Durability	Appearance	Apply 150% of the rated voltage for 1000±12 hours at the maximum operating temperature ±3°C. The charge/discharge current is less than 50mA. <ul style="list-style-type: none"> •Initial measurement Perform a heat treatment at 150±9₀°C for one hour and then let sit for 24±2 hours at room temperature. Perform the initial measurement. •Measurement after test Perform a heat treatment at 150±9₀°C for one hour and then let sit for 24±2 hours at room temperature, then measure. 															
		Capacitance Change		R6, R7, C7, C8: Within ±12.5% * LLL153C70G474: Within ±20%														
		D.F.		R6, R7, C7, C8: 0.2 max.														
		I.R.		25Ω · F min.														

Chip Monolithic Ceramic Capacitors



High-Q Type GJM Series

■ Features

1. Mobile Telecommunication and RF module, mainly
2. Quality improvement of telephone call, Low power Consumption, yield ratio improvement

■ Applications

VCO, PA, Mobile Telecommunication

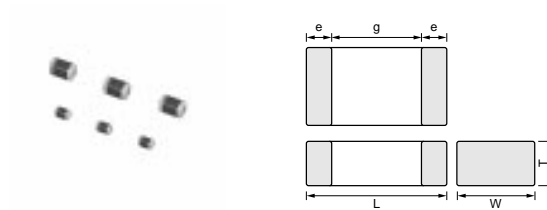

4

Part Number	Dimensions (mm)				
	L	W	T	e	g min.
GJM03	0.6 ±0.03	0.3 ±0.03	0.3 ±0.03	0.1 to 0.2	0.2
GJM15	1.0 ±0.05	0.5 ±0.05	0.5 ±0.05	0.15 to 0.3	0.4

Capacitance Table

Temperature Compensating Type C0G(5C)/C0H(6C) Characteristics

3 ex.3: T Dimension [mm]

Capacitance	LxW [mm]	0.6x0.3 (03) <0201>			1.0x0.5 (15) <0402>
		Rated Voltage [Vdc]	25 (1A)	6.3 (0J)	50 (1H)
0.1pF(R10)				5	
0.2pF(R20)	3			5	
0.3pF(R30)	3			5	
0.4pF(R40)	3			5	
0.5pF(R50)	3			5	
0.6pF(R60)	3			5	
0.7pF(R70)	3			5	
0.8pF(R80)	3			5	
0.9pF(R90)	3			5	
1.0pF(1R0)	3			5	
1.1pF(1R1)	3			5	
1.2pF(1R2)	3			5	
1.3pF(1R3)	3			5	
1.4pF(1R4)	3			5	
1.5pF(1R5)	3			5	
1.6pF(1R6)	3			5	
1.7pF(1R7)	3			5	
1.8pF(1R8)	3			5	
1.9pF(1R9)	3			5	
2.0pF(2R0)	3			5	
2.1pF(2R1)	3			5	
2.2pF(2R2)	3			5	
2.3pF(2R3)	3			5	
2.4pF(2R4)	3			5	
2.5pF(2R5)	3			5	
2.6pF(2R6)	3			5	
2.7pF(2R7)	3			5	
2.8pF(2R8)	3			5	
2.9pF(2R9)	3			5	
3.0pF(3R0)	3			5	
3.1pF(3R1)	3			5	
3.2pF(3R2)	3			5	
3.3pF(3R3)	3			5	
3.4pF(3R4)	3			5	
3.5pF(3R5)	3			5	
3.6pF(3R6)	3			5	
3.7pF(3R7)	3			5	
3.8pF(3R8)	3			5	
3.9pF(3R9)	3			5	
4.0pF(4R0)	3			5	
4.1pF(4R1)	3			5	
4.2pF(4R2)	3			5	
4.3pF(4R3)	3			5	
4.4pF(4R4)	3			5	
4.5pF(4R5)	3			5	
4.6pF(4R6)	3			5	
4.7pF(4R7)	3			5	
4.8pF(4R8)	3			5	
4.9pF(4R9)	3			5	

Capacitance	LxW [mm]	0.6x0.3 (03) <0201>			1.0x0.5 (15) <0402>
		Rated Voltage [Vdc]	25 (1A)	6.3 (0J)	50 (1H)
5.0pF(5R0)		3		5	
5.1pF(5R1)		3		5	
5.2pF(5R2)		3		5	
5.3pF(5R3)		3		5	
5.4pF(5R4)		3		5	
5.5pF(5R5)		3		5	
5.6pF(5R6)		3		5	
5.7pF(5R7)		3		5	
5.8pF(5R8)		3		5	
5.9pF(5R9)		3		5	
6.0pF(6R0)		3		5	
6.1pF(6R1)		3		5	
6.2pF(6R2)		3		5	
6.3pF(6R3)		3		5	
6.4pF(6R4)		3		5	
6.5pF(6R5)		3		5	
6.6pF(6R6)		3		5	
6.7pF(6R7)		3		5	
6.8pF(6R8)		3		5	
6.9pF(6R9)		3		5	
7.0pF(7R0)		3		5	
7.1pF(7R1)		3		5	
7.2pF(7R2)		3		5	
7.3pF(7R3)		3		5	
7.4pF(7R4)		3		5	
7.5pF(7R5)		3		5	
7.6pF(7R6)		3		5	
7.7pF(7R7)		3		5	
7.8pF(7R8)		3		5	
7.9pF(7R9)		3		5	
8.0pF(8R0)		3		5	
8.1pF(8R1)		3		5	
8.2pF(8R2)		3		5	
8.3pF(8R3)		3		5	
8.4pF(8R4)		3		5	
8.5pF(8R5)		3		5	
8.6pF(8R6)		3		5	
8.7pF(8R7)		3		5	
8.8pF(8R8)		3		5	
8.9pF(8R9)		3		5	
9.0pF(9R0)		3		5	
9.1pF(9R1)		3		5	
9.2pF(9R2)		3		5	
9.3pF(9R3)		3		5	
9.4pF(9R4)		3		5	
9.5pF(9R5)		3		5	
9.6pF(9R6)		3		5	
9.7pF(9R7)		3		5	
9.8pF(9R8)		3		5	

Capacitance	LxW [mm]	0.6x0.3 (03) <0201>			1.0x0.5 (15) <0402>
		Rated Voltage [Vdc]	25 (1A)	6.3 (0J)	50 (1H)
9.9pF(9R9)		3		5	
10pF(100)		3		5	
11pF(110)		3		5	
12pF(120)		3		5	
13pF(130)		3		5	
15pF(150)		3		5	
16pF(160)		3		5	
18pF(180)		3		5	
20pF(200)		3		5	
22pF(220)			3		
24pF(240)			3		
27pF(270)			3		
30pF(300)			3		
33pF(330)			3		

The part number code is shown in () and Unit is shown in []. < >: EIA [inch] Code

Temperature Compensating Type C0G(5C) Characteristics

LxW [mm]		0.6x0.3(03)<0201>	1.0x0.5(15)<0402>
Rated Volt. [Vdc]		25(1E)	50(1H)
Capacitance	Tolerance	Part Number	
0.1pF(R10)	±0.05pF(W)		GJM1555C1HR10WB01D
	±0.1pF(B)		GJM1555C1HR10BB01D
0.2pF(R20)	±0.05pF(W)	GJM0335C1ER20WB01D	GJM1555C1HR20WB01D
	±0.1pF(B)	GJM0335C1ER20BB01D	GJM1555C1HR20BB01D
0.3pF(R30)	±0.05pF(W)	GJM0335C1ER30WB01D	GJM1555C1HR30WB01D
	±0.1pF(B)	GJM0335C1ER30BB01D	GJM1555C1HR30BB01D
0.4pF(R40)	±0.05pF(W)	GJM0335C1ER40WB01D	GJM1555C1HR40WB01D
	±0.1pF(B)	GJM0335C1ER40BB01D	GJM1555C1HR40BB01D
0.5pF(R50)	±0.05pF(W)	GJM0335C1ER50WB01D	GJM1555C1HR50WB01D
	±0.1pF(B)	GJM0335C1ER50BB01D	GJM1555C1HR50BB01D
0.6pF(R60)	±0.05pF(W)	GJM0335C1ER60WB01D	GJM1555C1HR60WB01D
	±0.1pF(B)	GJM0335C1ER60BB01D	GJM1555C1HR60BB01D
0.7pF(R70)	±0.05pF(W)	GJM0335C1ER70WB01D	GJM1555C1HR70WB01D
	±0.1pF(B)	GJM0335C1ER70BB01D	GJM1555C1HR70BB01D
0.8pF(R80)	±0.05pF(W)	GJM0335C1ER80WB01D	GJM1555C1HR80WB01D
	±0.1pF(B)	GJM0335C1ER80BB01D	GJM1555C1HR80BB01D
0.9pF(R90)	±0.05pF(W)	GJM0335C1ER90WB01D	GJM1555C1HR90WB01D
	±0.1pF(B)	GJM0335C1ER90BB01D	GJM1555C1HR90BB01D
1.0pF(1R0)	±0.05pF(W)	GJM0335C1E1R0WB01D	GJM1555C1H1R0WB01D
	±0.1pF(B)	GJM0335C1E1R0BB01D	GJM1555C1H1R0BB01D
	±0.25pF(C)	GJM0335C1E1R0CB01D	GJM1555C1H1R0CB01D
1.1pF(1R1)	±0.05pF(W)	GJM0335C1E1R1WB01D	GJM1555C1H1R1WB01D
	±0.1pF(B)	GJM0335C1E1R1BB01D	GJM1555C1H1R1BB01D
	±0.25pF(C)	GJM0335C1E1R1CB01D	GJM1555C1H1R1CB01D
1.2pF(1R2)	±0.05pF(W)	GJM0335C1E1R2WB01D	GJM1555C1H1R2WB01D
	±0.1pF(B)	GJM0335C1E1R2BB01D	GJM1555C1H1R2BB01D
	±0.25pF(C)	GJM0335C1E1R2CB01D	GJM1555C1H1R2CB01D
1.3pF(1R3)	±0.05pF(W)	GJM0335C1E1R3WB01D	GJM1555C1H1R3WB01D
	±0.1pF(B)	GJM0335C1E1R3BB01D	GJM1555C1H1R3BB01D
	±0.25pF(C)	GJM0335C1E1R3CB01D	GJM1555C1H1R3CB01D
1.4pF(1R4)	±0.05pF(W)	GJM0335C1E1R4WB01D	GJM1555C1H1R4WB01D
	±0.1pF(B)	GJM0335C1E1R4BB01D	GJM1555C1H1R4BB01D
	±0.25pF(C)	GJM0335C1E1R4CB01D	GJM1555C1H1R4CB01D
1.5pF(1R5)	±0.05pF(W)	GJM0335C1E1R5WB01D	GJM1555C1H1R5WB01D
	±0.1pF(B)	GJM0335C1E1R5BB01D	GJM1555C1H1R5BB01D
	±0.25pF(C)	GJM0335C1E1R5CB01D	GJM1555C1H1R5CB01D
1.6pF(1R6)	±0.05pF(W)	GJM0335C1E1R6WB01D	GJM1555C1H1R6WB01D
	±0.1pF(B)	GJM0335C1E1R6BB01D	GJM1555C1H1R6BB01D
	±0.25pF(C)	GJM0335C1E1R6CB01D	GJM1555C1H1R6CB01D
1.7pF(1R7)	±0.05pF(W)	GJM0335C1E1R7WB01D	GJM1555C1H1R7WB01D
	±0.1pF(B)	GJM0335C1E1R7BB01D	GJM1555C1H1R7BB01D
	±0.25pF(C)	GJM0335C1E1R7CB01D	GJM1555C1H1R7CB01D
1.8pF(1R8)	±0.05pF(W)	GJM0335C1E1R8WB01D	GJM1555C1H1R8WB01D
	±0.1pF(B)	GJM0335C1E1R8BB01D	GJM1555C1H1R8BB01D
	±0.25pF(C)	GJM0335C1E1R8CB01D	GJM1555C1H1R8CB01D
1.9pF(1R9)	±0.05pF(W)	GJM0335C1E1R9WB01D	GJM1555C1H1R9WB01D
	±0.1pF(B)	GJM0335C1E1R9BB01D	GJM1555C1H1R9BB01D
	±0.25pF(C)	GJM0335C1E1R9CB01D	GJM1555C1H1R9CB01D
2.0pF(2R0)	±0.05pF(W)	GJM0335C1E2R0WB01D	GJM1555C1H2R0WB01D
	±0.1pF(B)	GJM0335C1E2R0BB01D	GJM1555C1H2R0BB01D
	±0.25pF(C)	GJM0335C1E2R0CB01D	GJM1555C1H2R0CB01D

The part number code is shown in () and Unit is shown in []. <->: EIA [inch] Code

(Part Number) **GJ** **M** **03** **3** **5C** **1E** **R20** **W** **B01** **D**

① Product ID ② Series
 ⑤ Temperature Characteristics
 ⑥ Capacitance Tolerance

③ Dimension (LxW)

④ Dimension (T)

⑦ Rated Voltage

⑧ Capacitance

⑨ Individual Specification Code

⑩ Packaging

Packaging Code in Part Number is a code shows STD 180mm Reel Taping.

Temperature Compensating Type C0G(5C) Characteristics

LxW [mm]		0.6x0.3(03)<0201>		1.0x0.5(15)<0402>	
Rated Volt. [Vdc]		25(1E)		50(1H)	
Capacitance	Tolerance	Part Number			
2.1pF(2R1)	±0.05pF(W)	GJM0335C1E2R1WB01D	GJM1555C1H2R1WB01D		
	±0.1pF(B)	GJM0335C1E2R1BB01D	GJM1555C1H2R1BB01D		
	±0.25pF(C)	GJM0335C1E2R1CB01D	GJM1555C1H2R1CB01D		
2.2pF(2R2)	±0.05pF(W)	GJM0335C1E2R2WB01D	GJM1555C1H2R2WB01D		
	±0.1pF(B)	GJM0335C1E2R2BB01D	GJM1555C1H2R2BB01D		
	±0.25pF(C)	GJM0335C1E2R2CB01D	GJM1555C1H2R2CB01D		
2.3pF(2R3)	±0.05pF(W)	GJM0335C1E2R3WB01D	GJM1555C1H2R3WB01D		
	±0.1pF(B)	GJM0335C1E2R3BB01D	GJM1555C1H2R3BB01D		
	±0.25pF(C)	GJM0335C1E2R3CB01D	GJM1555C1H2R3CB01D		
2.4pF(2R4)	±0.05pF(W)	GJM0335C1E2R4WB01D	GJM1555C1H2R4WB01D		
	±0.1pF(B)	GJM0335C1E2R4BB01D	GJM1555C1H2R4BB01D		
	±0.25pF(C)	GJM0335C1E2R4CB01D	GJM1555C1H2R4CB01D		
2.5pF(2R5)	±0.05pF(W)	GJM0335C1E2R5WB01D	GJM1555C1H2R5WB01D		
	±0.1pF(B)	GJM0335C1E2R5BB01D	GJM1555C1H2R5BB01D		
	±0.25pF(C)	GJM0335C1E2R5CB01D	GJM1555C1H2R5CB01D		
2.6pF(2R6)	±0.05pF(W)	GJM0335C1E2R6WB01D	GJM1555C1H2R6WB01D		
	±0.1pF(B)	GJM0335C1E2R6BB01D	GJM1555C1H2R6BB01D		
	±0.25pF(C)	GJM0335C1E2R6CB01D	GJM1555C1H2R6CB01D		
2.7pF(2R7)	±0.05pF(W)	GJM0335C1E2R7WB01D	GJM1555C1H2R7WB01D		
	±0.1pF(B)	GJM0335C1E2R7BB01D	GJM1555C1H2R7BB01D		
	±0.25pF(C)	GJM0335C1E2R7CB01D	GJM1555C1H2R7CB01D		
2.8pF(2R8)	±0.05pF(W)	GJM0335C1E2R8WB01D	GJM1555C1H2R8WB01D		
	±0.1pF(B)	GJM0335C1E2R8BB01D	GJM1555C1H2R8BB01D		
	±0.25pF(C)	GJM0335C1E2R8CB01D	GJM1555C1H2R8CB01D		
2.9pF(2R9)	±0.05pF(W)	GJM0335C1E2R9WB01D	GJM1555C1H2R9WB01D		
	±0.1pF(B)	GJM0335C1E2R9BB01D	GJM1555C1H2R9BB01D		
	±0.25pF(C)	GJM0335C1E2R9CB01D	GJM1555C1H2R9CB01D		
3.0pF(3R0)	±0.05pF(W)	GJM0335C1E3R0WB01D	GJM1555C1H3R0WB01D		
	±0.1pF(B)	GJM0335C1E3R0BB01D	GJM1555C1H3R0BB01D		
	±0.25pF(C)	GJM0335C1E3R0CB01D	GJM1555C1H3R0CB01D		
3.1pF(3R1)	±0.05pF(W)	GJM0335C1E3R1WB01D	GJM1555C1H3R1WB01D		
	±0.1pF(B)	GJM0335C1E3R1BB01D	GJM1555C1H3R1BB01D		
	±0.25pF(C)	GJM0335C1E3R1CB01D	GJM1555C1H3R1CB01D		
3.2pF(3R2)	±0.05pF(W)	GJM0335C1E3R2WB01D	GJM1555C1H3R2WB01D		
	±0.1pF(B)	GJM0335C1E3R2BB01D	GJM1555C1H3R2BB01D		
	±0.25pF(C)	GJM0335C1E3R2CB01D	GJM1555C1H3R2CB01D		
3.3pF(3R3)	±0.05pF(W)	GJM0335C1E3R3WB01D	GJM1555C1H3R3WB01D		
	±0.1pF(B)	GJM0335C1E3R3BB01D	GJM1555C1H3R3BB01D		
	±0.25pF(C)	GJM0335C1E3R3CB01D	GJM1555C1H3R3CB01D		
3.4pF(3R4)	±0.05pF(W)	GJM0335C1E3R4WB01D	GJM1555C1H3R4WB01D		
	±0.1pF(B)	GJM0335C1E3R4BB01D	GJM1555C1H3R4BB01D		
	±0.25pF(C)	GJM0335C1E3R4CB01D	GJM1555C1H3R4CB01D		
3.5pF(3R5)	±0.05pF(W)	GJM0335C1E3R5WB01D	GJM1555C1H3R5WB01D		
	±0.1pF(B)	GJM0335C1E3R5BB01D	GJM1555C1H3R5BB01D		
	±0.25pF(C)	GJM0335C1E3R5CB01D	GJM1555C1H3R5CB01D		
3.6pF(3R6)	±0.05pF(W)	GJM0335C1E3R6WB01D	GJM1555C1H3R6WB01D		
	±0.1pF(B)	GJM0335C1E3R6BB01D	GJM1555C1H3R6BB01D		
	±0.25pF(C)	GJM0335C1E3R6CB01D	GJM1555C1H3R6CB01D		

The part number code is shown in () and Unit is shown in []. < >: EIA [inch] Code

(Part Number) **GJ** **M** **03** **3** **5C** **1E** **2R1** **W** **B01** **D**
 ① ② ③ ④ ⑤ ⑥ ⑦ ⑧ ⑨ ⑩

① Product ID
 ② Series
 ⑤ Temperature Characteristics
 ⑥ Capacitance Tolerance

③ Dimension (LxW)
 ⑥ Rated Voltage
 ⑨ Individual Specification Code

④ Dimension (T)
 ⑦ Capacitance
 ⑩ Packaging

Packaging Code in Part Number is a code shows STD 180mm Reel Taping.

Temperature Compensating Type C0G(5C) Characteristics

LxW [mm]		0.6x0.3(03)<0201>		1.0x0.5(15)<0402>	
Rated Volt. [Vdc]		25(1E)		50(1H)	
Capacitance	Tolerance	Part Number			
3.7pF(3R7)	±0.05pF(W)	GJM0335C1E3R7WB01D	GJM1555C1H3R7WB01D		
	±0.1pF(B)	GJM0335C1E3R7BB01D	GJM1555C1H3R7BB01D		
	±0.25pF(C)	GJM0335C1E3R7CB01D	GJM1555C1H3R7CB01D		
3.8pF(3R8)	±0.05pF(W)	GJM0335C1E3R8WB01D	GJM1555C1H3R8WB01D		
	±0.1pF(B)	GJM0335C1E3R8BB01D	GJM1555C1H3R8BB01D		
	±0.25pF(C)	GJM0335C1E3R8CB01D	GJM1555C1H3R8CB01D		
3.9pF(3R9)	±0.05pF(W)	GJM0335C1E3R9WB01D	GJM1555C1H3R9WB01D		
	±0.1pF(B)	GJM0335C1E3R9BB01D	GJM1555C1H3R9BB01D		
	±0.25pF(C)	GJM0335C1E3R9CB01D	GJM1555C1H3R9CB01D		
4.0pF(4R0)	±0.05pF(W)	GJM0335C1E4R0WB01D	GJM1555C1H4R0WB01D		
	±0.1pF(B)	GJM0335C1E4R0BB01D	GJM1555C1H4R0BB01D		
	±0.25pF(C)	GJM0335C1E4R0CB01D	GJM1555C1H4R0CB01D		
4.1pF(4R1)	±0.05pF(W)	GJM0335C1E4R1WB01D	GJM1555C1H4R1WB01D		
	±0.1pF(B)	GJM0335C1E4R1BB01D	GJM1555C1H4R1BB01D		
	±0.25pF(C)	GJM0335C1E4R1CB01D	GJM1555C1H4R1CB01D		
4.2pF(4R2)	±0.05pF(W)	GJM0335C1E4R2WB01D	GJM1555C1H4R2WB01D		
	±0.1pF(B)	GJM0335C1E4R2BB01D	GJM1555C1H4R2BB01D		
	±0.25pF(C)	GJM0335C1E4R2CB01D	GJM1555C1H4R2CB01D		
4.3pF(4R3)	±0.05pF(W)	GJM0335C1E4R3WB01D	GJM1555C1H4R3WB01D		
	±0.1pF(B)	GJM0335C1E4R3BB01D	GJM1555C1H4R3BB01D		
	±0.25pF(C)	GJM0335C1E4R3CB01D	GJM1555C1H4R3CB01D		
4.4pF(4R4)	±0.05pF(W)	GJM0335C1E4R4WB01D	GJM1555C1H4R4WB01D		
	±0.1pF(B)	GJM0335C1E4R4BB01D	GJM1555C1H4R4BB01D		
	±0.25pF(C)	GJM0335C1E4R4CB01D	GJM1555C1H4R4CB01D		
4.5pF(4R5)	±0.05pF(W)	GJM0335C1E4R5WB01D	GJM1555C1H4R5WB01D		
	±0.1pF(B)	GJM0335C1E4R5BB01D	GJM1555C1H4R5BB01D		
	±0.25pF(C)	GJM0335C1E4R5CB01D	GJM1555C1H4R5CB01D		
4.6pF(4R6)	±0.05pF(W)	GJM0335C1E4R6WB01D	GJM1555C1H4R6WB01D		
	±0.1pF(B)	GJM0335C1E4R6BB01D	GJM1555C1H4R6BB01D		
	±0.25pF(C)	GJM0335C1E4R6CB01D	GJM1555C1H4R6CB01D		
4.7pF(4R7)	±0.05pF(W)	GJM0335C1E4R7WB01D	GJM1555C1H4R7WB01D		
	±0.1pF(B)	GJM0335C1E4R7BB01D	GJM1555C1H4R7BB01D		
	±0.25pF(C)	GJM0335C1E4R7CB01D	GJM1555C1H4R7CB01D		
4.8pF(4R8)	±0.05pF(W)	GJM0335C1E4R8WB01D	GJM1555C1H4R8WB01D		
	±0.1pF(B)	GJM0335C1E4R8BB01D	GJM1555C1H4R8BB01D		
	±0.25pF(C)	GJM0335C1E4R8CB01D	GJM1555C1H4R8CB01D		
4.9pF(4R9)	±0.05pF(W)	GJM0335C1E4R9WB01D	GJM1555C1H4R9WB01D		
	±0.1pF(B)	GJM0335C1E4R9BB01D	GJM1555C1H4R9BB01D		
	±0.25pF(C)	GJM0335C1E4R9CB01D	GJM1555C1H4R9CB01D		
5.0pF(5R0)	±0.05pF(W)	GJM0335C1E5R0WB01D	GJM1555C1H5R0WB01D		
	±0.1pF(B)	GJM0335C1E5R0BB01D	GJM1555C1H5R0BB01D		
	±0.25pF(C)	GJM0335C1E5R0CB01D	GJM1555C1H5R0CB01D		
5.1pF(5R1)	±0.05pF(W)	GJM0335C1E5R1WB01D	GJM1555C1H5R1WB01D		
	±0.1pF(B)	GJM0335C1E5R1BB01D	GJM1555C1H5R1BB01D		
	±0.25pF(C)	GJM0335C1E5R1CB01D	GJM1555C1H5R1CB01D		
	±0.5pF(D)	GJM0335C1E5R1DB01D	GJM1555C1H5R1DB01D		
5.2pF(5R2)	±0.05pF(W)	GJM0335C1E5R2WB01D	GJM1555C1H5R2WB01D		
	±0.1pF(B)	GJM0335C1E5R2BB01D	GJM1555C1H5R2BB01D		
	±0.25pF(C)	GJM0335C1E5R2CB01D	GJM1555C1H5R2CB01D		
	±0.5pF(D)	GJM0335C1E5R2DB01D	GJM1555C1H5R2DB01D		

The part number code is shown in () and Unit is shown in []. < >: EIA [inch] Code

Temperature Compensating Type C0G(5C) Characteristics

LxW [mm]		0.6x0.3(03)<0201>		1.0x0.5(15)<0402>	
Rated Volt. [Vdc]		25(1E)		50(1H)	
Capacitance	Tolerance	Part Number			
5.3pF(5R3)	±0.05pF(W)	GJM0335C1E5R3WB01D	GJM1555C1H5R3WB01D		
	±0.1pF(B)	GJM0335C1E5R3BB01D	GJM1555C1H5R3BB01D		
	±0.25pF(C)	GJM0335C1E5R3CB01D	GJM1555C1H5R3CB01D		
	±0.5pF(D)	GJM0335C1E5R3DB01D	GJM1555C1H5R3DB01D		
5.4pF(5R4)	±0.05pF(W)	GJM0335C1E5R4WB01D	GJM1555C1H5R4WB01D		
	±0.1pF(B)	GJM0335C1E5R4BB01D	GJM1555C1H5R4BB01D		
	±0.25pF(C)	GJM0335C1E5R4CB01D	GJM1555C1H5R4CB01D		
	±0.5pF(D)	GJM0335C1E5R4DB01D	GJM1555C1H5R4DB01D		
5.5pF(5R5)	±0.05pF(W)	GJM0335C1E5R5WB01D	GJM1555C1H5R5WB01D		
	±0.1pF(B)	GJM0335C1E5R5BB01D	GJM1555C1H5R5BB01D		
	±0.25pF(C)	GJM0335C1E5R5CB01D	GJM1555C1H5R5CB01D		
	±0.5pF(D)	GJM0335C1E5R5DB01D	GJM1555C1H5R5DB01D		
5.6pF(5R6)	±0.05pF(W)	GJM0335C1E5R6WB01D	GJM1555C1H5R6WB01D		
	±0.1pF(B)	GJM0335C1E5R6BB01D	GJM1555C1H5R6BB01D		
	±0.25pF(C)	GJM0335C1E5R6CB01D	GJM1555C1H5R6CB01D		
	±0.5pF(D)	GJM0335C1E5R6DB01D	GJM1555C1H5R6DB01D		
5.7pF(5R7)	±0.05pF(W)	GJM0335C1E5R7WB01D	GJM1555C1H5R7WB01D		
	±0.1pF(B)	GJM0335C1E5R7BB01D	GJM1555C1H5R7BB01D		
	±0.25pF(C)	GJM0335C1E5R7CB01D	GJM1555C1H5R7CB01D		
	±0.5pF(D)	GJM0335C1E5R7DB01D	GJM1555C1H5R7DB01D		
5.8pF(5R8)	±0.05pF(W)	GJM0335C1E5R8WB01D	GJM1555C1H5R8WB01D		
	±0.1pF(B)	GJM0335C1E5R8BB01D	GJM1555C1H5R8BB01D		
	±0.25pF(C)	GJM0335C1E5R8CB01D	GJM1555C1H5R8CB01D		
	±0.5pF(D)	GJM0335C1E5R8DB01D	GJM1555C1H5R8DB01D		
5.9pF(5R9)	±0.05pF(W)	GJM0335C1E5R9WB01D	GJM1555C1H5R9WB01D		
	±0.1pF(B)	GJM0335C1E5R9BB01D	GJM1555C1H5R9BB01D		
	±0.25pF(C)	GJM0335C1E5R9CB01D	GJM1555C1H5R9CB01D		
	±0.5pF(D)	GJM0335C1E5R9DB01D	GJM1555C1H5R9DB01D		
6.0pF(6R0)	±0.05pF(W)	GJM0335C1E6R0WB01D	GJM1555C1H6R0WB01D		
	±0.1pF(B)	GJM0335C1E6R0BB01D	GJM1555C1H6R0BB01D		
	±0.25pF(C)	GJM0335C1E6R0CB01D	GJM1555C1H6R0CB01D		
	±0.5pF(D)	GJM0335C1E6R0DB01D	GJM1555C1H6R0DB01D		
6.1pF(6R1)	±0.05pF(W)	GJM0335C1E6R1WB01D	GJM1555C1H6R1WB01D		
	±0.1pF(B)	GJM0335C1E6R1BB01D	GJM1555C1H6R1BB01D		
	±0.25pF(C)	GJM0335C1E6R1CB01D	GJM1555C1H6R1CB01D		
	±0.5pF(D)	GJM0335C1E6R1DB01D	GJM1555C1H6R1DB01D		
6.2pF(6R2)	±0.05pF(W)	GJM0335C1E6R2WB01D	GJM1555C1H6R2WB01D		
	±0.1pF(B)	GJM0335C1E6R2BB01D	GJM1555C1H6R2BB01D		
	±0.25pF(C)	GJM0335C1E6R2CB01D	GJM1555C1H6R2CB01D		
	±0.5pF(D)	GJM0335C1E6R2DB01D	GJM1555C1H6R2DB01D		
6.3pF(6R3)	±0.05pF(W)	GJM0335C1E6R3WB01D	GJM1555C1H6R3WB01D		
	±0.1pF(B)	GJM0335C1E6R3BB01D	GJM1555C1H6R3BB01D		
	±0.25pF(C)	GJM0335C1E6R3CB01D	GJM1555C1H6R3CB01D		
	±0.5pF(D)	GJM0335C1E6R3DB01D	GJM1555C1H6R3DB01D		
6.4pF(6R4)	±0.05pF(W)	GJM0335C1E6R4WB01D	GJM1555C1H6R4WB01D		
	±0.1pF(B)	GJM0335C1E6R4BB01D	GJM1555C1H6R4BB01D		
	±0.25pF(C)	GJM0335C1E6R4CB01D	GJM1555C1H6R4CB01D		
	±0.5pF(D)	GJM0335C1E6R4DB01D	GJM1555C1H6R4DB01D		

The part number code is shown in () and Unit is shown in []. < >: EIA [inch] Code

(Part Number) **GJ** **M** **03** **3** **5C** **1E** **5R3** **W** **B01** **D**

① ② ③ ④ ⑤ ⑥ ⑦ ⑧ ⑨ ⑩

① Product ID
② Series
⑤ Temperature Characteristics
⑥ Capacitance Tolerance

③ Dimension (LxW)
④ Dimension (T)
⑦ Rated Voltage
⑧ Capacitance
⑨ Individual Specification Code

④ Dimension (T)
⑦ Capacitance
⑩ Packaging

Packaging Code in Part Number is a code shows STD 180mm Reel Taping.

Temperature Compensating Type C0G(5C)/C0H(6C) Characteristics

LxW [mm]		0.6x0.3(03)<0201>		1.0x0.5(15)<0402>	
Rated Volt. [Vdc]		25(1E)		50(1H)	
Capacitance	Tolerance	Part Number			
6.5pF(6R5)	±0.05pF(W)	GJM0335C1E6R5WB01D	GJM1555C1H6R5WB01D		
	±0.1pF(B)	GJM0335C1E6R5BB01D	GJM1555C1H6R5BB01D		
	±0.25pF(C)	GJM0335C1E6R5CB01D	GJM1555C1H6R5CB01D		
	±0.5pF(D)	GJM0335C1E6R5DB01D	GJM1555C1H6R5DB01D		
6.6pF(6R6)	±0.05pF(W)	GJM0335C1E6R6WB01D	GJM1555C1H6R6WB01D		
	±0.1pF(B)	GJM0335C1E6R6BB01D	GJM1555C1H6R6BB01D		
	±0.25pF(C)	GJM0335C1E6R6CB01D	GJM1555C1H6R6CB01D		
	±0.5pF(D)	GJM0335C1E6R6DB01D	GJM1555C1H6R6DB01D		
6.7pF(6R7)	±0.05pF(W)	GJM0335C1E6R7WB01D	GJM1555C1H6R7WB01D		
	±0.1pF(B)	GJM0335C1E6R7BB01D	GJM1555C1H6R7BB01D		
	±0.25pF(C)	GJM0335C1E6R7CB01D	GJM1555C1H6R7CB01D		
	±0.5pF(D)	GJM0335C1E6R7DB01D	GJM1555C1H6R7DB01D		
6.8pF(6R8)	±0.05pF(W)	GJM0335C1E6R8WB01D	GJM1555C1H6R8WB01D		
	±0.1pF(B)	GJM0335C1E6R8BB01D	GJM1555C1H6R8BB01D		
	±0.25pF(C)	GJM0335C1E6R8CB01D	GJM1555C1H6R8CB01D		
	±0.5pF(D)	GJM0335C1E6R8DB01D	GJM1555C1H6R8DB01D		
6.9pF(6R9)	±0.05pF(W)	GJM0336C1E6R9WB01D	GJM1555C1H6R9WB01D		
	±0.1pF(B)	GJM0336C1E6R9BB01D	GJM1555C1H6R9BB01D		
	±0.25pF(C)	GJM0336C1E6R9CB01D	GJM1555C1H6R9CB01D		
	±0.5pF(D)	GJM0336C1E6R9DB01D	GJM1555C1H6R9DB01D		
7.0pF(7R0)	±0.05pF(W)	GJM0336C1E7R0WB01D	GJM1555C1H7R0WB01D		
	±0.1pF(B)	GJM0336C1E7R0BB01D	GJM1555C1H7R0BB01D		
	±0.25pF(C)	GJM0336C1E7R0CB01D	GJM1555C1H7R0CB01D		
	±0.5pF(D)	GJM0336C1E7R0DB01D	GJM1555C1H7R0DB01D		
7.1pF(7R1)	±0.05pF(W)	GJM0336C1E7R1WB01D	GJM1555C1H7R1WB01D		
	±0.1pF(B)	GJM0336C1E7R1BB01D	GJM1555C1H7R1BB01D		
	±0.25pF(C)	GJM0336C1E7R1CB01D	GJM1555C1H7R1CB01D		
	±0.5pF(D)	GJM0336C1E7R1DB01D	GJM1555C1H7R1DB01D		
7.2pF(7R2)	±0.05pF(W)	GJM0336C1E7R2WB01D	GJM1555C1H7R2WB01D		
	±0.1pF(B)	GJM0336C1E7R2BB01D	GJM1555C1H7R2BB01D		
	±0.25pF(C)	GJM0336C1E7R2CB01D	GJM1555C1H7R2CB01D		
	±0.5pF(D)	GJM0336C1E7R2DB01D	GJM1555C1H7R2DB01D		
7.3pF(7R3)	±0.05pF(W)	GJM0336C1E7R3WB01D	GJM1555C1H7R3WB01D		
	±0.1pF(B)	GJM0336C1E7R3BB01D	GJM1555C1H7R3BB01D		
	±0.25pF(C)	GJM0336C1E7R3CB01D	GJM1555C1H7R3CB01D		
	±0.5pF(D)	GJM0336C1E7R3DB01D	GJM1555C1H7R3DB01D		
7.4pF(7R4)	±0.05pF(W)	GJM0336C1E7R4WB01D	GJM1555C1H7R4WB01D		
	±0.1pF(B)	GJM0336C1E7R4BB01D	GJM1555C1H7R4BB01D		
	±0.25pF(C)	GJM0336C1E7R4CB01D	GJM1555C1H7R4CB01D		
	±0.5pF(D)	GJM0336C1E7R4DB01D	GJM1555C1H7R4DB01D		
7.5pF(7R5)	±0.05pF(W)	GJM0336C1E7R5WB01D	GJM1555C1H7R5WB01D		
	±0.1pF(B)	GJM0336C1E7R5BB01D	GJM1555C1H7R5BB01D		
	±0.25pF(C)	GJM0336C1E7R5CB01D	GJM1555C1H7R5CB01D		
	±0.5pF(D)	GJM0336C1E7R5DB01D	GJM1555C1H7R5DB01D		
7.6pF(7R6)	±0.05pF(W)	GJM0336C1E7R6WB01D	GJM1555C1H7R6WB01D		
	±0.1pF(B)	GJM0336C1E7R6BB01D	GJM1555C1H7R6BB01D		
	±0.25pF(C)	GJM0336C1E7R6CB01D	GJM1555C1H7R6CB01D		
	±0.5pF(D)	GJM0336C1E7R6DB01D	GJM1555C1H7R6DB01D		
7.7pF(7R7)	±0.05pF(W)	GJM0336C1E7R7WB01D	GJM1555C1H7R7WB01D		
	±0.1pF(B)	GJM0336C1E7R7BB01D	GJM1555C1H7R7BB01D		
	±0.25pF(C)	GJM0336C1E7R7CB01D	GJM1555C1H7R7CB01D		
	±0.5pF(D)	GJM0336C1E7R7DB01D	GJM1555C1H7R7DB01D		

The part number code is shown in () and Unit is shown in []. < >: EIA [inch] Code

Temperature Compensating Type C0G(5C)/C0H(6C) Characteristics

LxW [mm]		0.6x0.3(03)<0201>		1.0x0.5(15)<0402>	
Rated Volt. [Vdc]		25(1E)		50(1H)	
Capacitance	Tolerance	Part Number			
7.8pF(7R8)	±0.05pF(W)	GJM0336C1E7R8WB01D	GJM1555C1H7R8WB01D		
	±0.1pF(B)	GJM0336C1E7R8BB01D	GJM1555C1H7R8BB01D		
	±0.25pF(C)	GJM0336C1E7R8CB01D	GJM1555C1H7R8CB01D		
	±0.5pF(D)	GJM0336C1E7R8DB01D	GJM1555C1H7R8DB01D		
7.9pF(7R9)	±0.05pF(W)	GJM0336C1E7R9WB01D	GJM1555C1H7R9WB01D		
	±0.1pF(B)	GJM0336C1E7R9BB01D	GJM1555C1H7R9BB01D		
	±0.25pF(C)	GJM0336C1E7R9CB01D	GJM1555C1H7R9CB01D		
	±0.5pF(D)	GJM0336C1E7R9DB01D	GJM1555C1H7R9DB01D		
8.0pF(8R0)	±0.05pF(W)	GJM0336C1E8R0WB01D	GJM1555C1H8R0WB01D		
	±0.1pF(B)	GJM0336C1E8R0BB01D	GJM1555C1H8R0BB01D		
	±0.25pF(C)	GJM0336C1E8R0CB01D	GJM1555C1H8R0CB01D		
	±0.5pF(D)	GJM0336C1E8R0DB01D	GJM1555C1H8R0DB01D		
8.1pF(8R1)	±0.05pF(W)	GJM0336C1E8R1WB01D	GJM1555C1H8R1WB01D		
	±0.1pF(B)	GJM0336C1E8R1BB01D	GJM1555C1H8R1BB01D		
	±0.25pF(C)	GJM0336C1E8R1CB01D	GJM1555C1H8R1CB01D		
	±0.5pF(D)	GJM0336C1E8R1DB01D	GJM1555C1H8R1DB01D		
8.2pF(8R2)	±0.05pF(W)	GJM0336C1E8R2WB01D	GJM1555C1H8R2WB01D		
	±0.1pF(B)	GJM0336C1E8R2BB01D	GJM1555C1H8R2BB01D		
	±0.25pF(C)	GJM0336C1E8R2CB01D	GJM1555C1H8R2CB01D		
	±0.5pF(D)	GJM0336C1E8R2DB01D	GJM1555C1H8R2DB01D		
8.3pF(8R3)	±0.05pF(W)	GJM0336C1E8R3WB01D	GJM1555C1H8R3WB01D		
	±0.1pF(B)	GJM0336C1E8R3BB01D	GJM1555C1H8R3BB01D		
	±0.25pF(C)	GJM0336C1E8R3CB01D	GJM1555C1H8R3CB01D		
	±0.5pF(D)	GJM0336C1E8R3DB01D	GJM1555C1H8R3DB01D		
8.4pF(8R4)	±0.05pF(W)	GJM0336C1E8R4WB01D	GJM1555C1H8R4WB01D		
	±0.1pF(B)	GJM0336C1E8R4BB01D	GJM1555C1H8R4BB01D		
	±0.25pF(C)	GJM0336C1E8R4CB01D	GJM1555C1H8R4CB01D		
	±0.5pF(D)	GJM0336C1E8R4DB01D	GJM1555C1H8R4DB01D		
8.5pF(8R5)	±0.05pF(W)	GJM0336C1E8R5WB01D	GJM1555C1H8R5WB01D		
	±0.1pF(B)	GJM0336C1E8R5BB01D	GJM1555C1H8R5BB01D		
	±0.25pF(C)	GJM0336C1E8R5CB01D	GJM1555C1H8R5CB01D		
	±0.5pF(D)	GJM0336C1E8R5DB01D	GJM1555C1H8R5DB01D		
8.6pF(8R6)	±0.05pF(W)	GJM0336C1E8R6WB01D	GJM1555C1H8R6WB01D		
	±0.1pF(B)	GJM0336C1E8R6BB01D	GJM1555C1H8R6BB01D		
	±0.25pF(C)	GJM0336C1E8R6CB01D	GJM1555C1H8R6CB01D		
	±0.5pF(D)	GJM0336C1E8R6DB01D	GJM1555C1H8R6DB01D		
8.7pF(8R7)	±0.05pF(W)	GJM0336C1E8R7WB01D	GJM1555C1H8R7WB01D		
	±0.1pF(B)	GJM0336C1E8R7BB01D	GJM1555C1H8R7BB01D		
	±0.25pF(C)	GJM0336C1E8R7CB01D	GJM1555C1H8R7CB01D		
	±0.5pF(D)	GJM0336C1E8R7DB01D	GJM1555C1H8R7DB01D		
8.8pF(8R8)	±0.05pF(W)	GJM0336C1E8R8WB01D	GJM1555C1H8R8WB01D		
	±0.1pF(B)	GJM0336C1E8R8BB01D	GJM1555C1H8R8BB01D		
	±0.25pF(C)	GJM0336C1E8R8CB01D	GJM1555C1H8R8CB01D		
	±0.5pF(D)	GJM0336C1E8R8DB01D	GJM1555C1H8R8DB01D		
8.9pF(8R9)	±0.05pF(W)	GJM0336C1E8R9WB01D	GJM1555C1H8R9WB01D		
	±0.1pF(B)	GJM0336C1E8R9BB01D	GJM1555C1H8R9BB01D		
	±0.25pF(C)	GJM0336C1E8R9CB01D	GJM1555C1H8R9CB01D		
	±0.5pF(D)	GJM0336C1E8R9DB01D	GJM1555C1H8R9DB01D		

The part number code is shown in () and Unit is shown in []. < >: EIA [inch] Code

(Part Number) **GJ** **M** **03** **3** **6C** **1E** **7R8** **W** **B01** **D**

① ② ③ ④ ⑤ ⑥ ⑦ ⑧ ⑨ ⑩

- ① Product ID
- ② Series
- ③ Dimension (LxW)
- ④ Dimension (T)
- ⑤ Temperature Characteristics
- ⑥ Rated Voltage
- ⑦ Capacitance
- ⑧ Capacitance Tolerance
- ⑨ Individual Specification Code
- ⑩ Packaging

Packaging Code in Part Number is a code shows STD 180mm Reel Taping.

Temperature Compensating Type C0G(5C)/C0H(6C) Characteristics

LxW [mm]		0.6x0.3(03)<0201>		1.0x0.5(15)<0402>	
Rated Volt. [Vdc]		25(1E)		50(1H)	
Capacitance	Tolerance	Part Number			
9.0pF(9R0)	±0.05pF(W)	GJM0336C1E9R0WB01D	GJM1555C1H9R0WB01D		
	±0.1pF(B)	GJM0336C1E9R0BB01D	GJM1555C1H9R0BB01D		
	±0.25pF(C)	GJM0336C1E9R0CB01D	GJM1555C1H9R0CB01D		
	±0.5pF(D)	GJM0336C1E9R0DB01D	GJM1555C1H9R0DB01D		
9.1pF(9R1)	±0.05pF(W)	GJM0336C1E9R1WB01D	GJM1555C1H9R1WB01D		
	±0.1pF(B)	GJM0336C1E9R1BB01D	GJM1555C1H9R1BB01D		
	±0.25pF(C)	GJM0336C1E9R1CB01D	GJM1555C1H9R1CB01D		
	±0.5pF(D)	GJM0336C1E9R1DB01D	GJM1555C1H9R1DB01D		
9.2pF(9R2)	±0.05pF(W)	GJM0336C1E9R2WB01D	GJM1555C1H9R2WB01D		
	±0.1pF(B)	GJM0336C1E9R2BB01D	GJM1555C1H9R2BB01D		
	±0.25pF(C)	GJM0336C1E9R2CB01D	GJM1555C1H9R2CB01D		
	±0.5pF(D)	GJM0336C1E9R2DB01D	GJM1555C1H9R2DB01D		
9.3pF(9R3)	±0.05pF(W)	GJM0336C1E9R3WB01D	GJM1555C1H9R3WB01D		
	±0.1pF(B)	GJM0336C1E9R3BB01D	GJM1555C1H9R3BB01D		
	±0.25pF(C)	GJM0336C1E9R3CB01D	GJM1555C1H9R3CB01D		
	±0.5pF(D)	GJM0336C1E9R3DB01D	GJM1555C1H9R3DB01D		
9.4pF(9R4)	±0.05pF(W)	GJM0336C1E9R4WB01D	GJM1555C1H9R4WB01D		
	±0.1pF(B)	GJM0336C1E9R4BB01D	GJM1555C1H9R4BB01D		
	±0.25pF(C)	GJM0336C1E9R4CB01D	GJM1555C1H9R4CB01D		
	±0.5pF(D)	GJM0336C1E9R4DB01D	GJM1555C1H9R4DB01D		
9.5pF(9R5)	±0.05pF(W)	GJM0336C1E9R5WB01D	GJM1555C1H9R5WB01D		
	±0.1pF(B)	GJM0336C1E9R5BB01D	GJM1555C1H9R5BB01D		
	±0.25pF(C)	GJM0336C1E9R5CB01D	GJM1555C1H9R5CB01D		
	±0.5pF(D)	GJM0336C1E9R5DB01D	GJM1555C1H9R5DB01D		
9.6pF(9R6)	±0.05pF(W)	GJM0336C1E9R6WB01D	GJM1555C1H9R6WB01D		
	±0.1pF(B)	GJM0336C1E9R6BB01D	GJM1555C1H9R6BB01D		
	±0.25pF(C)	GJM0336C1E9R6CB01D	GJM1555C1H9R6CB01D		
	±0.5pF(D)	GJM0336C1E9R6DB01D	GJM1555C1H9R6DB01D		
9.7pF(9R7)	±0.05pF(W)	GJM0336C1E9R7WB01D	GJM1555C1H9R7WB01D		
	±0.1pF(B)	GJM0336C1E9R7BB01D	GJM1555C1H9R7BB01D		
	±0.25pF(C)	GJM0336C1E9R7CB01D	GJM1555C1H9R7CB01D		
	±0.5pF(D)	GJM0336C1E9R7DB01D	GJM1555C1H9R7DB01D		
9.8pF(9R8)	±0.05pF(W)	GJM0336C1E9R8WB01D	GJM1555C1H9R8WB01D		
	±0.1pF(B)	GJM0336C1E9R8BB01D	GJM1555C1H9R8BB01D		
	±0.25pF(C)	GJM0336C1E9R8CB01D	GJM1555C1H9R8CB01D		
	±0.5pF(D)	GJM0336C1E9R8DB01D	GJM1555C1H9R8DB01D		
9.9pF(9R9)	±0.05pF(W)	GJM0336C1E9R9WB01D	GJM1555C1H9R9WB01D		
	±0.1pF(B)	GJM0336C1E9R9BB01D	GJM1555C1H9R9BB01D		
	±0.25pF(C)	GJM0336C1E9R9CB01D	GJM1555C1H9R9CB01D		
	±0.5pF(D)	GJM0336C1E9R9DB01D	GJM1555C1H9R9DB01D		

The part number code is shown in () and Unit is shown in []. <->: EIA [inch] Code

4

Temperature Compensating Type C0G(5C)/C0H(6C) Characteristics

LxW [mm]		0.6x0.3(03)<0201>		1.0x0.5(15)<0402>
Rated Volt. [Vdc]		25(1E)	6.3(0J)	50(1H)
Capacitance	Tolerance	Part Number		
10pF(100)	±2%(G)	GJM0336C1E100GB01D		GJM1555C1H100GB01D
	±5%(J)	GJM0336C1E100JB01D		GJM1555C1H100JB01D
11pF(110)	±2%(G)	GJM0336C1E110GB01D		GJM1555C1H110GB01D
	±5%(J)	GJM0336C1E110JB01D		GJM1555C1H110JB01D
12pF(120)	±2%(G)	GJM0336C1E120GB01D		GJM1555C1H120GB01D
	±5%(J)	GJM0336C1E120JB01D		GJM1555C1H120JB01D
13pF(130)	±2%(G)	GJM0336C1E130GB01D		GJM1555C1H130GB01D
	±5%(J)	GJM0336C1E130JB01D		GJM1555C1H130JB01D
15pF(150)	±2%(G)	GJM0336C1E150GB01D		GJM1555C1H150GB01D
	±5%(J)	GJM0336C1E150JB01D		GJM1555C1H150JB01D
16pF(160)	±2%(G)	GJM0336C1E160GB01D		GJM1555C1H160GB01D
	±5%(J)	GJM0336C1E160JB01D		GJM1555C1H160JB01D
18pF(180)	±2%(G)	GJM0336C1E180GB01D		GJM1555C1H180GB01D
	±5%(J)	GJM0336C1E180JB01D		GJM1555C1H180JB01D
20pF(200)	±2%(G)	GJM0336C1E200GB01D		GJM1555C1H200GB01D
	±5%(J)	GJM0336C1E200JB01D		GJM1555C1H200JB01D
22pF(220)	±2%(G)		GJM0335C0J220GB01D	
	±5%(J)		GJM0335C0J220JB01D	
24pF(240)	±2%(G)		GJM0335C0J240GB01D	
	±5%(J)		GJM0335C0J240JB01D	
27pF(270)	±2%(G)		GJM0335C0J270GB01D	
	±5%(J)		GJM0335C0J270JB01D	
30pF(300)	±2%(G)		GJM0335C0J300GB01D	
	±5%(J)		GJM0335C0J300JB01D	
33pF(330)	±2%(G)		GJM0335C0J330GB01D	
	±5%(J)		GJM0335C0J330JB01D	

The part number code is shown in () and Unit is shown in []. < >: EIA [inch] Code

(Part Number) **GJ** **M** **03** **3** **6C** **1E** **100** **G** **B01** **D**
 ① ② ③ ④ ⑤ ⑥ ⑦ ⑧ ⑨ ⑩

① Product ID ② Series
 ⑤ Temperature Characteristics
 ⑥ Capacitance Tolerance

③ Dimension (LxW)
 ⑥ Rated Voltage
 ⑨ Individual Specification Code

④ Dimension (T)
 ⑦ Capacitance
 ⑩ Packaging

Packaging Code in Part Number is a code shows STD 180mm Reel Taping.

GJM Series Specifications and Test Methods

4

No.	Item	Specifications		Test Method				
		Temperature Compensating Type						
1	Operating Temperature Range	-55 to +125°C		Reference Temperature: 25°C (2C, 3C, 4C: 20°C)				
2	Rated Voltage	See the previous pages.		The rated voltage is defined as the maximum voltage which may be applied continuously to the capacitor. When AC voltage is superimposed on DC voltage, V^{P-P} or V^{O-P} , whichever is larger, should be maintained within the rated voltage range.				
3	Appearance	No defects or abnormalities		Visual inspection				
4	Dimensions	Within the specified dimensions		Using calipers				
5	Dielectric Strength	No defects or abnormalities		No failure should be observed when 300% of the rated voltage is applied between the terminations for 1 to 5 seconds, provided the charge/discharge current is less than 50mA.				
6	Insulation Resistance (I.R.)	10,000MΩ min. or 500Ω · F min. (Whichever is smaller)		The insulation resistance should be measured with a DC voltage not exceeding the rated voltage at 25°C and 75%RH max. and within 2 minutes of charging.				
7	Capacitance	Within the specified tolerance		The capacitance/Q should be measured at 25°C at the frequency and voltage shown in the table.				
8	Q	30pF and over: $Q \geq 1000$ 30pF and below: $Q \geq 400 + 20C$ C: Nominal Capacitance (pF)		<table border="1" style="margin-left: auto; margin-right: auto;"> <tr> <td>Frequency</td> <td>1±0.1MHz</td> </tr> <tr> <td>Voltage</td> <td>0.5 to 5Vrms</td> </tr> </table>	Frequency	1±0.1MHz	Voltage	0.5 to 5Vrms
		Frequency	1±0.1MHz					
Voltage	0.5 to 5Vrms							
9	Capacitance Temperature Characteristics	Temperature Coefficient	Within the specified tolerance (Table A)	The capacitance change should be measured after 5 min. at each specified temperature stage. Temperature Compensating Type The temperature coefficient is determined using the capacitance measured in step 3 as a reference. When cycling the temperature sequentially from step 1 through 5, (5C: +25 to 125°C; other temp. coeffs.: +20 to 125°C) the capacitance should be within the specified tolerance for the temperature coefficient and capacitance change as Table A. The capacitance drift is calculated by dividing the differences between the maximum and minimum measured values in steps 1, 3 and 5 by the capacitance value in step 3.				
	Capacitance Drift	Capacitance Drift	Within ±0.2% or ±0.05pF (Whichever is larger.)					
10	Adhesive Strength of Termination	No removal of the terminations or other defect should occur.		Solder the capacitor to the test jig (glass epoxy board) shown in Fig. 1 using a eutectic solder. Then apply a 5N* force in parallel with the test jig for 10±1 sec. The soldering should be done either with an iron or using the reflow method and should be conducted with care so that the soldering is uniform and free of defects such as heat shock. *2N (GJM03)				

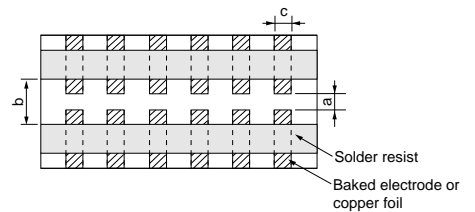

Type	a	b	c
GJM03	0.3	0.9	0.3
GJM15	0.4	1.5	0.5

(in mm)

Fig. 1

Continued on the following page.

GJM Series Specifications and Test Methods

Continued from the preceding page.

4

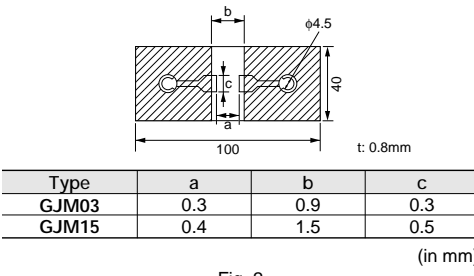
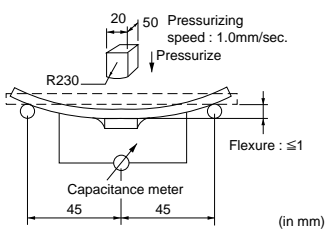
No.	Item	Specifications		Test Method										
		Temperature Compensating Type												
11	Appearance	No defects or abnormalities		Solder the capacitor to the test jig (glass epoxy board) in the same manner and under the same conditions as (10). The capacitor should be subjected to a simple harmonic motion having a total amplitude of 1.5mm, the frequency being varied uniformly between the approximate limits of 10 and 55Hz. The frequency range, from 10 to 55Hz and return to 10Hz, should be traversed in approximately 1 minute. This motion should be applied for a period of 2 hours in each of 3 mutually perpendicular directions (total of 6 hours).										
	Capacitance	Within the specified tolerance												
	Q	30pF and over: $Q \geq 1000$ 30pF and below: $Q \geq 400 + 20C$ C: Nominal Capacitance (pF)												
12	Appearance	No marking defects		Solder the capacitor to the test jig (glass epoxy boards) shown in Fig. 2 using a eutectic solder. Then apply a force in the direction shown in Fig. 3. The soldering should be done by the reflow method and should be conducted with care so that the soldering is uniform and free of defects such as heat shock.										
	Capacitance Change	Within $\pm 5\%$ or $\pm 0.5pF$ (Whichever is larger)												
		 <table border="1" data-bbox="414 808 885 913"> <thead> <tr> <th>Type</th> <th>a</th> <th>b</th> <th>c</th> </tr> </thead> <tbody> <tr> <td>GJM03</td> <td>0.3</td> <td>0.9</td> <td>0.3</td> </tr> <tr> <td>GJM15</td> <td>0.4</td> <td>1.5</td> <td>0.5</td> </tr> </tbody> </table> <p>(in mm)</p>			Type	a	b	c	GJM03	0.3	0.9	0.3	GJM15	0.4
Type	a	b	c											
GJM03	0.3	0.9	0.3											
GJM15	0.4	1.5	0.5											
	 <p>(in mm)</p>													
13	Solderability of Termination	75% of the terminations are to be soldered evenly and continuously.		Immerse the capacitor in a solution of ethanol (JIS-K-8101) and rosin (JIS-K-5902) (25% rosin in weight proportion). Preheat at 80 to 120°C for 10 to 30 seconds. After preheating, immerse in eutectic solder solution for 2 ± 0.5 seconds at $230 \pm 5^\circ C$ or Sn-3.0Ag-0.5Cu solder solution for 2 ± 0.5 seconds at $245 \pm 5^\circ C$.										
14	The measured and observed characteristics should satisfy the specifications in the following table.		Preheat the capacitor at 120 to 150°C for 1 minute. Immerse the capacitor in a eutectic solder or Sn-3.0Ag-0.5Cu solder solution at $270 \pm 5^\circ C$ for 10 ± 0.5 seconds. Let sit at room temperature for 24 ± 2 hours.											
	Appearance	No marking defects												
	Capacitance Change	Within $\pm 2.5\%$ or $\pm 0.25pF$ (Whichever is larger)												
	Q	30pF and over: $Q \geq 1000$ 30pF and below: $Q \geq 400 + 20C$ C: Nominal Capacitance (pF)												
	I.R.	More than 10,000M Ω or 500 $\Omega \cdot F$ (Whichever is smaller)												
15	The measured and observed characteristics should satisfy the specifications in the following table.		Fix the capacitor to the supporting jig in the same manner and under the same conditions as (10). Perform the five cycles according to the four heat treatments listed in the following table. Let sit for 24 ± 2 hours at room temperature, then measure.											
	Appearance	No marking defects												
	Capacitance Change	Within $\pm 2.5\%$ or $\pm 0.25pF$ (Whichever is larger)												
	Q	30pF and over: $Q \geq 1000$ 30pF and below: $Q \geq 400 + 20C$ C: Nominal Capacitance (pF)												
	I.R.	More than 10,000M Ω or 500 $\Omega \cdot F$ (Whichever is smaller)												
16	The measured and observed characteristics should satisfy the specifications in the following table.		Let the capacitor sit at $40 \pm 2^\circ C$ and 90 to 95% humidity for 500 ± 12 hours. Remove and let sit for 24 ± 2 hours (temperature compensating type) at room temperature, then measure.											
	Appearance	No marking defects												
	Capacitance Change	Within $\pm 5\%$ or $\pm 0.5pF$ (Whichever is larger)												
	Q	30pF and below: $Q \geq 350$ 10pF and over, 30pF and below: $Q \geq 275 + \frac{C}{5}$ 10pF and below: $Q \geq 200 + 10C$ C: Nominal Capacitance (pF)												
	I.R.	More than 10,000M Ω or 500 $\Omega \cdot F$ (Whichever is smaller)												

Step	1	2	3	4
Temp. ($^\circ C$)	Min. Operating Temp. ± 3	Room Temp.	Max. Operating Temp. ± 3	Room Temp.
Time (min.)	30 ± 3	2 to 3	30 ± 3	2 to 3

Continued on the following page. 

GJM Series Specifications and Test Methods

Continued from the preceding page.

No.	Item	Specifications		Test Method
		Temperature Compensating Type		
17	Humidity Load	The measured and observed characteristics should satisfy the specifications in the following table.		Apply the rated voltage at 40±2°C and 90 to 95% humidity for 500±12 hours. Remove and let sit for 24±2 hours at room temperature, then measure. The charge/discharge current is less than 50mA.
		Appearance	No marking defects	
		Capacitance Change	Within ±7.5% or ±0.75pF (Whichever is larger)	
		Q	30pF and over: Q≥200 30pF and below: Q≥100+ $\frac{1}{C}$ C C: Nominal Capacitance (pF)	
	I.R.	More than 500MΩ or 25Ω · F (Whichever is smaller)		
18	High Temperature Load	The measured and observed characteristics should satisfy the specifications in the following table.		Apply 200% of the rated voltage for 1000±12 hours at the maximum operating temperature ±3°C. Let sit for 24±2 hours (temperature compensating type) at room temperature, then measure. The charge/discharge current is less than 50mA.
		Appearance	No marking defects	
		Capacitance Change	Within ±3% or ±0.3pF (Whichever is larger)	
		Q	30pF and over: Q≥350 10pF and over, 30pF and below: Q≥275+ $\frac{1}{C}$ C 10pF and below: Q≥200+10C C: Nominal Capacitance (pF)	
	I.R.	More than 1,000MΩ or 50Ω · F (Whichever is smaller)		
19	ESR	0.1pF<C≤1pF: 350mΩ · pF below 1pF<C≤5pF: 300mΩ below 5pF<C≤10pF: 250mΩ below		The ESR should be measured at room temperature, and frequency 1±0.2GHz with the equivalent of BOONTON Model 34A.
		10pF<C≤33pF: 400mΩ below		The ESR should be measured at room temperature, and frequency 500±50MHz with the equivalent of HP8753B.

4

Table A
(1)

Char. Code	Temp. Coeff. (ppm/°C) *1	Capacitance Change from 25°C Value (%)					
		-55°C		-30°C		-10°C	
		Max.	Min.	Max.	Min.	Max.	Min.
5C	0±30	0.58	-0.24	0.40	-0.17	0.25	-0.11
6C	0±60	0.87	-0.48	0.60	-0.33	0.38	-0.21

*1: Nominal values denote the temperature coefficient within a range of 25 to 125°C.

(2)

Char.	Nominal Values (ppm/°C) *2	Capacitance Change from 20°C Value (%)					
		-55°C		-25°C		-10°C	
		Max.	Min.	Max.	Min.	Max.	Min.
2C	0±60	0.82	-0.45	0.49	-0.27	0.33	-0.18
3C	0±120	1.37	-0.90	0.82	-0.54	0.55	-0.36
4C	0±250	2.56	-1.88	1.54	-1.13	1.02	-0.75

*2: Nominal values denote the temperature coefficient within a range of 20 to 125°C.

Chip Monolithic Ceramic Capacitors



High Frequency GQM Series

■ Features

1. HiQ and low ESR at VHF, UHF, Microwave
2. Feature improvement, low power consumption for mobile telecommunication. (Base station, terminal, etc.)

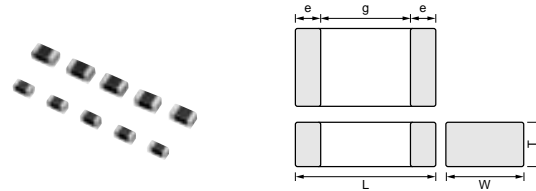

■ Applications

High frequency circuit (Mobile telecommunication, etc.)

Part Number	Dimensions (mm)				
	L	W	T	e	g min.
GQM187	1.6 ±0.15	0.8 ±0.15	0.7 ±0.1	0.2 to 0.5	0.5
GQM188	1.6 ±0.1	0.8 ±0.1	0.8 ±0.1	0.2 to 0.5	0.5
GQM219 (50,100V)	2.0 ±0.1	1.25 ±0.1	0.85 ±0.1	0.2 to 0.7	0.7
GQM219 (250V)	2.0 ±0.15	1.25 ±0.15	0.85 ±0.15	0.2 to 0.7	0.7

Capacitance Table

Temperature Compensating Type C0G(5C) Characteristics

7 ex.7: T Dimension [mm]

Capacitance	TC	LxW [mm]	C0G(5C)						
			1.6x0.8 (18) <0603>			2.0x1.25 (21) <0805>			
			Rated Voltage [Vdc]	250 (2E)	100 (2A)	50 (1H)	250 (2E)	100 (2A)	50 (1H)
0.10pF(R10)	7								
0.20pF(R20)	7								
0.30pF(R30)	7								
0.40pF(R40)	7								
0.50pF(R50)	7	8				9	9		
0.75pF(R75)	7	8				9	9		
1.0pF(1R0)	7	8				9	9		
1.1pF(1R1)	7	8				9	9		
1.2pF(1R2)	7	8				9	9		
1.3pF(1R3)	7	8				9	9		
1.5pF(1R5)	7	8				9	9		
1.6pF(1R6)	7	8				9	9		
1.8pF(1R8)	7	8				9	9		
2.0pF(2R0)	7	8				9	9		
2.2pF(2R2)	7	8				9	9		
2.4pF(2R4)	7	8				9	9		
2.7pF(2R7)	7	8				9	9		
3.0pF(3R0)	7	8				9	9		
3.3pF(3R3)	7	8				9	9		
3.6pF(3R6)	7	8				9	9		
3.9pF(3R9)	7	8				9	9		
4.0pF(4R0)	7	8				9	9		
4.3pF(4R3)	7	8				9	9		
4.7pF(4R7)	7	8				9	9		
5.0pF(5R0)	7	8				9	9		
5.1pF(5R1)	7	8				9	9		
5.6pF(5R6)	7	8				9	9		
6.0pF(6R0)	7	8				9	9		
6.2pF(6R2)	7	8				9	9		
6.8pF(6R8)	7	8				9	9		
7.0pF(7R0)	7		8			9	9		

Capacitance	TC	LxW [mm]	C0G(5C)						
			1.6x0.8 (18) <0603>			2.0x1.25 (21) <0805>			
			Rated Voltage [Vdc]	250 (2E)	100 (2A)	50 (1H)	250 (2E)	100 (2A)	50 (1H)
7.5pF(7R5)	7					8	9	9	
8.0pF(8R0)	7					8	9	9	
8.2pF(8R2)	7					8	9	9	
9.0pF(9R0)	7					8	9	9	
9.1pF(9R1)	7					8	9	9	
10pF(100)	7					8	9	9	
11pF(110)	7					8	9	9	
12pF(120)	7					8	9	9	
13pF(130)	7					8	9	9	
15pF(150)	7					8	9	9	
16pF(160)	7					8	9	9	
18pF(180)	7					8	9	9	
20pF(200)	7					8	9		9
22pF(220)	7					8	9		9
24pF(240)	7					8	9		9
27pF(270)	7					8	9		9
30pF(300)	7					8	9		9
33pF(330)	7					8	9		9
36pF(360)	7					8	9		9
39pF(390)	7					8	9		9
43pF(430)	7					8	9		9
47pF(470)	7					8	9		9
51pF(510)						8	9		9
56pF(560)						8	9		9
62pF(620)						8	9		9
68pF(680)						8	9		9
75pF(750)						8	9		9
82pF(820)						8	9		9
91pF(910)						8	9		9
100pF(101)						8	9		9

The part number code is shown in () and Unit is shown in []. < >: EIA [inch] Code

Temperature Compensating Type C0G(5C) Characteristics

LxW [mm]		1.6x0.8(18)<0603>	
Rated Volt. [Vdc]		250(2E)	100(2A)
Capacitance	Tolerance	Part Number	
0.10pF(R10)	±0.1pF(B)	GQM1875C2ER10BB12D	
0.20pF(R20)	±0.1pF(B)	GQM1875C2ER20BB12D	
0.30pF(R30)	±0.1pF(B)	GQM1875C2ER30BB12D	
	±0.25pF(C)	GQM1875C2ER30CB12D	
0.40pF(R40)	±0.1pF(B)	GQM1875C2ER40BB12D	
	±0.25pF(C)	GQM1875C2ER40CB12D	
0.50pF(R50)	±0.1pF(B)	GQM1875C2ER50BB12D	GQM1885C2AR50BB01D
	±0.25pF(C)	GQM1875C2ER50CB12D	GQM1885C2AR50CB01D
0.75pF(R75)	±0.1pF(B)	GQM1875C2ER75BB12D	GQM1885C2AR75BB01D
	±0.25pF(C)	GQM1875C2ER75CB12D	GQM1885C2AR75CB01D
1.0pF(1R0)	±0.1pF(B)	GQM1875C2E1R0BB12D	GQM1885C2A1R0BB01D
	±0.25pF(C)	GQM1875C2E1R0CB12D	GQM1885C2A1R0CB01D
1.1pF(1R1)	±0.1pF(B)	GQM1875C2E1R1BB12D	GQM1885C2A1R1BB01D
	±0.25pF(C)	GQM1875C2E1R1CB12D	GQM1885C2A1R1CB01D
1.2pF(1R2)	±0.1pF(B)	GQM1875C2E1R2BB12D	GQM1885C2A1R2BB01D
	±0.25pF(C)	GQM1875C2E1R2CB12D	GQM1885C2A1R2CB01D
1.3pF(1R3)	±0.1pF(B)	GQM1875C2E1R3BB12D	GQM1885C2A1R3BB01D
	±0.25pF(C)	GQM1875C2E1R3CB12D	GQM1885C2A1R3CB01D
1.5pF(1R5)	±0.1pF(B)	GQM1875C2E1R5BB12D	GQM1885C2A1R5BB01D
	±0.25pF(C)	GQM1875C2E1R5CB12D	GQM1885C2A1R5CB01D
1.6pF(1R6)	±0.1pF(B)	GQM1875C2E1R6BB12D	GQM1885C2A1R6BB01D
	±0.25pF(C)	GQM1875C2E1R6CB12D	GQM1885C2A1R6CB01D
1.8pF(1R8)	±0.1pF(B)	GQM1875C2E1R8BB12D	GQM1885C2A1R8BB01D
	±0.25pF(C)	GQM1875C2E1R8CB12D	GQM1885C2A1R8CB01D
2.0pF(2R0)	±0.1pF(B)	GQM1875C2E2R0BB12D	GQM1885C2A2R0BB01D
	±0.25pF(C)	GQM1875C2E2R0CB12D	GQM1885C2A2R0CB01D
2.2pF(2R2)	±0.1pF(B)	GQM1875C2E2R2BB12D	GQM1885C2A2R2BB01D
	±0.25pF(C)	GQM1875C2E2R2CB12D	GQM1885C2A2R2CB01D
2.4pF(2R4)	±0.1pF(B)	GQM1875C2E2R4BB12D	GQM1885C2A2R4BB01D
	±0.25pF(C)	GQM1875C2E2R4CB12D	GQM1885C2A2R4CB01D
2.7pF(2R7)	±0.1pF(B)	GQM1875C2E2R7BB12D	GQM1885C2A2R7BB01D
	±0.25pF(C)	GQM1875C2E2R7CB12D	GQM1885C2A2R7CB01D
3.0pF(3R0)	±0.1pF(B)	GQM1875C2E3R0BB12D	GQM1885C2A3R0BB01D
	±0.25pF(C)	GQM1875C2E3R0CB12D	GQM1885C2A3R0CB01D
3.3pF(3R3)	±0.1pF(B)	GQM1875C2E3R3BB12D	GQM1885C2A3R3BB01D
	±0.25pF(C)	GQM1875C2E3R3CB12D	GQM1885C2A3R3CB01D
3.6pF(3R6)	±0.1pF(B)	GQM1875C2E3R6BB12D	GQM1885C2A3R6BB01D
	±0.25pF(C)	GQM1875C2E3R6CB12D	GQM1885C2A3R6CB01D
3.9pF(3R9)	±0.1pF(B)	GQM1875C2E3R9BB12D	GQM1885C2A3R9BB01D
	±0.25pF(C)	GQM1875C2E3R9CB12D	GQM1885C2A3R9CB01D
4.0pF(4R0)	±0.1pF(B)	GQM1875C2E4R0BB12D	GQM1885C2A4R0BB01D
	±0.25pF(C)	GQM1875C2E4R0CB12D	GQM1885C2A4R0CB01D
4.3pF(4R3)	±0.1pF(B)	GQM1875C2E4R3BB12D	GQM1885C2A4R3BB01D
	±0.25pF(C)	GQM1875C2E4R3CB12D	GQM1885C2A4R3CB01D
4.7pF(4R7)	±0.1pF(B)	GQM1875C2E4R7BB12D	GQM1885C2A4R7BB01D
	±0.25pF(C)	GQM1875C2E4R7CB12D	GQM1885C2A4R7CB01D
5.0pF(5R0)	±0.1pF(B)	GQM1875C2E5R0BB12D	GQM1885C2A5R0BB01D
	±0.25pF(C)	GQM1875C2E5R0CB12D	GQM1885C2A5R0CB01D

The part number code is shown in () and Unit is shown in []. < >: EIA [inch] Code

(Part Number) **GQ** **M** **18** **7** **5C** **2E** **R10** **B** **B12** **D**
 ① ② ③ ④ ⑤ ⑥ ⑦ ⑧ ⑨ ⑩

① Product ID ② Series
 ⑤ Temperature Characteristics
 ⑥ Capacitance Tolerance

③ Dimension (LxW)
 ⑥ Rated Voltage
 ⑨ Individual Specification Code

④ Dimension (T)
 ⑦ Capacitance
 ⑩ Packaging

Packaging Code in Part Number is a code shows STD 180mm Reel Taping.



Temperature Compensating Type C0G(5C) Characteristics

LxW [mm]		1.6x0.8(18)<0603>		
Rated Volt. [Vdc]		250(2E)	100(2A)	50(1H)
Capacitance	Tolerance	Part Number		
5.1pF(5R1)	±0.25pF(C)	GQM1875C2E5R1CB12D	GQM1885C2A5R1CB01D	
	±0.5pF(D)	GQM1875C2E5R1DB12D	GQM1885C2A5R1DB01D	
5.6pF(5R6)	±0.25pF(C)	GQM1875C2E5R6CB12D	GQM1885C2A5R6CB01D	
	±0.5pF(D)	GQM1875C2E5R6DB12D	GQM1885C2A5R6DB01D	
6.0pF(6R0)	±0.25pF(C)	GQM1875C2E6R0CB12D	GQM1885C2A6R0CB01D	
	±0.5pF(D)	GQM1875C2E6R0DB12D	GQM1885C2A6R0DB01D	
6.2pF(6R2)	±0.25pF(C)	GQM1875C2E6R2CB12D	GQM1885C2A6R2CB01D	
	±0.5pF(D)	GQM1875C2E6R2DB12D	GQM1885C2A6R2DB01D	
6.8pF(6R8)	±0.25pF(C)	GQM1875C2E6R8CB12D	GQM1885C2A6R8CB01D	
	±0.5pF(D)	GQM1875C2E6R8DB12D	GQM1885C2A6R8DB01D	
7.0pF(7R0)	±0.25pF(C)	GQM1875C2E7R0CB12D		GQM1885C1H7R0CB01D
	±0.5pF(D)	GQM1875C2E7R0DB12D		GQM1885C1H7R0DB01D
7.5pF(7R5)	±0.25pF(C)	GQM1875C2E7R5CB12D		GQM1885C1H7R5CB01D
	±0.5pF(D)	GQM1875C2E7R5DB12D		GQM1885C1H7R5DB01D
8.0pF(8R0)	±0.25pF(C)	GQM1875C2E8R0CB12D		GQM1885C1H8R0CB01D
	±0.5pF(D)	GQM1875C2E8R0DB12D		GQM1885C1H8R0DB01D
8.2pF(8R2)	±0.25pF(C)	GQM1875C2E8R2CB12D		GQM1885C1H8R2CB01D
	±0.5pF(D)	GQM1875C2E8R2DB12D		GQM1885C1H8R2DB01D
9.0pF(9R0)	±0.25pF(C)	GQM1875C2E9R0CB12D		GQM1885C1H9R0CB01D
	±0.5pF(D)	GQM1875C2E9R0DB12D		GQM1885C1H9R0DB01D
9.1pF(9R1)	±0.25pF(C)	GQM1875C2E9R1CB12D		GQM1885C1H9R1CB01D
	±0.5pF(D)	GQM1875C2E9R1DB12D		GQM1885C1H9R1DB01D
10pF(100)	±2%(G)	GQM1875C2E100GB12D		GQM1885C1H100GB01D
	±5%(J)	GQM1875C2E100JB12D		GQM1885C1H100JB01D
11pF(110)	±2%(G)	GQM1875C2E110GB12D		GQM1885C1H110GB01D
	±5%(J)	GQM1875C2E110JB12D		GQM1885C1H110JB01D
12pF(120)	±2%(G)	GQM1875C2E120GB12D		GQM1885C1H120GB01D
	±5%(J)	GQM1875C2E120JB12D		GQM1885C1H120JB01D
13pF(130)	±2%(G)	GQM1875C2E130GB12D		GQM1885C1H130GB01D
	±5%(J)	GQM1875C2E130JB12D		GQM1885C1H130JB01D
15pF(150)	±2%(G)	GQM1875C2E150GB12D		GQM1885C1H150GB01D
	±5%(J)	GQM1875C2E150JB12D		GQM1885C1H150JB01D
16pF(160)	±2%(G)	GQM1875C2E160GB12D		GQM1885C1H160GB01D
	±5%(J)	GQM1875C2E160JB12D		GQM1885C1H160JB01D
18pF(180)	±2%(G)	GQM1875C2E180GB12D		GQM1885C1H180GB01D
	±5%(J)	GQM1875C2E180JB12D		GQM1885C1H180JB01D
20pF(200)	±2%(G)	GQM1875C2E200GB12D		GQM1885C1H200GB01D
	±5%(J)	GQM1875C2E200JB12D		GQM1885C1H200JB01D
22pF(220)	±2%(G)	GQM1875C2E220GB12D		GQM1885C1H220GB01D
	±5%(J)	GQM1875C2E220JB12D		GQM1885C1H220JB01D
24pF(240)	±2%(G)	GQM1875C2E240GB12D		GQM1885C1H240GB01D
	±5%(J)	GQM1875C2E240JB12D		GQM1885C1H240JB01D
27pF(270)	±2%(G)	GQM1875C2E270GB12D		GQM1885C1H270GB01D
	±5%(J)	GQM1875C2E270JB12D		GQM1885C1H270JB01D
30pF(300)	±2%(G)	GQM1875C2E300GB12D		GQM1885C1H300GB01D
	±5%(J)	GQM1875C2E300JB12D		GQM1885C1H300JB01D

The part number code is shown in () and Unit is shown in []. <->: EIA [inch] Code

(Part Number) **GQ** **M** **18** **7** **5C** **2E** **5R1** **C** **B12** **D**
 ① ② ③ ④ ⑤ ⑥ ⑦ ⑧ ⑨ ⑩

① Product ID ② Series
 ⑤ Temperature Characteristics ⑥ Dimension (LxW)
 ⑦ Capacitance Tolerance ⑧ Rated Voltage
 ⑨ Individual Specification Code ⑩ Dimension (T)
 ⑩ Packaging

Packaging Code in Part Number is a code shows STD 180mm Reel Taping.

Temperature Compensating Type C0G(5C) Characteristics

LxW [mm]		1.6x0.8(18)<0603>	
Rated Volt. [Vdc]		250(2E)	50(1H)
Capacitance	Tolerance	Part Number	
33pF(330)	±2%(G)	GQM1875C2E330GB12D	GQM1885C1H330GB01D
	±5%(J)	GQM1875C2E330JB12D	GQM1885C1H330JB01D
36pF(360)	±2%(G)	GQM1875C2E360GB12D	GQM1885C1H360GB01D
	±5%(J)	GQM1875C2E360JB12D	GQM1885C1H360JB01D
39pF(390)	±2%(G)	GQM1875C2E390GB12D	GQM1885C1H390GB01D
	±5%(J)	GQM1875C2E390JB12D	GQM1885C1H390JB01D
43pF(430)	±2%(G)	GQM1875C2E430GB12D	GQM1885C1H430GB01D
	±5%(J)	GQM1875C2E430JB12D	GQM1885C1H430JB01D
47pF(470)	±2%(G)	GQM1875C2E470GB12D	GQM1885C1H470GB01D
	±5%(J)	GQM1875C2E470JB12D	GQM1885C1H470JB01D
51pF(510)	±2%(G)		GQM1885C1H510GB01D
	±5%(J)		GQM1885C1H510JB01D
56pF(560)	±2%(G)		GQM1885C1H560GB01D
	±5%(J)		GQM1885C1H560JB01D
62pF(620)	±2%(G)		GQM1885C1H620GB01D
	±5%(J)		GQM1885C1H620JB01D
68pF(680)	±2%(G)		GQM1885C1H680GB01D
	±5%(J)		GQM1885C1H680JB01D
75pF(750)	±2%(G)		GQM1885C1H750GB01D
	±5%(J)		GQM1885C1H750JB01D
82pF(820)	±2%(G)		GQM1885C1H820GB01D
	±5%(J)		GQM1885C1H820JB01D
91pF(910)	±2%(G)		GQM1885C1H910GB01D
	±5%(J)		GQM1885C1H910JB01D
100pF(101)	±2%(G)		GQM1885C1H101GB01D
	±5%(J)		GQM1885C1H101JB01D

The part number code is shown in () and Unit is shown in []. < >: EIA [inch] Code

Temperature Compensating Type C0G(5C) Characteristics

LxW [mm]		2.0x1.25(21)<0805>	
Rated Volt. [Vdc]		250(2E)	100(2A)
Capacitance	Tolerance	Part Number	
0.50pF(R50)	±0.1pF(B)	GQM2195C2ER50BB12D	GQM2195C2AR50BB01D
	±0.25pF(C)	GQM2195C2ER50CB12D	GQM2195C2AR50CB01D
0.75pF(R75)	±0.1pF(B)	GQM2195C2ER75BB12D	GQM2195C2AR75BB01D
	±0.25pF(C)	GQM2195C2ER75CB12D	GQM2195C2AR75CB01D
1.0pF(1R0)	±0.1pF(B)	GQM2195C2E1R0BB12D	GQM2195C2A1R0BB01D
	±0.25pF(C)	GQM2195C2E1R0CB12D	GQM2195C2A1R0CB01D
1.1pF(1R1)	±0.1pF(B)	GQM2195C2E1R1BB12D	GQM2195C2A1R1BB01D
	±0.25pF(C)	GQM2195C2E1R1CB12D	GQM2195C2A1R1CB01D
1.2pF(1R2)	±0.1pF(B)	GQM2195C2E1R2BB12D	GQM2195C2A1R2BB01D
	±0.25pF(C)	GQM2195C2E1R2CB12D	GQM2195C2A1R2CB01D
1.3pF(1R3)	±0.1pF(B)	GQM2195C2E1R3BB12D	GQM2195C2A1R3BB01D
	±0.25pF(C)	GQM2195C2E1R3CB12D	GQM2195C2A1R3CB01D
1.5pF(1R5)	±0.1pF(B)	GQM2195C2E1R5BB12D	GQM2195C2A1R5BB01D
	±0.25pF(C)	GQM2195C2E1R5CB12D	GQM2195C2A1R5CB01D
1.6pF(1R6)	±0.1pF(B)	GQM2195C2E1R6BB12D	GQM2195C2A1R6BB01D
	±0.25pF(C)	GQM2195C2E1R6CB12D	GQM2195C2A1R6CB01D
1.8pF(1R8)	±0.1pF(B)	GQM2195C2E1R8BB12D	GQM2195C2A1R8BB01D
	±0.25pF(C)	GQM2195C2E1R8CB12D	GQM2195C2A1R8CB01D
2.0pF(2R0)	±0.1pF(B)	GQM2195C2E2R0BB12D	GQM2195C2A2R0BB01D
	±0.25pF(C)	GQM2195C2E2R0CB12D	GQM2195C2A2R0CB01D
2.2pF(2R2)	±0.1pF(B)	GQM2195C2E2R2BB12D	GQM2195C2A2R2BB01D
	±0.25pF(C)	GQM2195C2E2R2CB12D	GQM2195C2A2R2CB01D
2.4pF(2R4)	±0.1pF(B)	GQM2195C2E2R4BB12D	GQM2195C2A2R4BB01D
	±0.25pF(C)	GQM2195C2E2R4CB12D	GQM2195C2A2R4CB01D
2.7pF(2R7)	±0.1pF(B)	GQM2195C2E2R7BB12D	GQM2195C2A2R7BB01D
	±0.25pF(C)	GQM2195C2E2R7CB12D	GQM2195C2A2R7CB01D
3.0pF(3R0)	±0.1pF(B)	GQM2195C2E3R0BB12D	GQM2195C2A3R0BB01D
	±0.25pF(C)	GQM2195C2E3R0CB12D	GQM2195C2A3R0CB01D
3.3pF(3R3)	±0.1pF(B)	GQM2195C2E3R3BB12D	GQM2195C2A3R3BB01D
	±0.25pF(C)	GQM2195C2E3R3CB12D	GQM2195C2A3R3CB01D
3.6pF(3R6)	±0.1pF(B)	GQM2195C2E3R6BB12D	GQM2195C2A3R6BB01D
	±0.25pF(C)	GQM2195C2E3R6CB12D	GQM2195C2A3R6CB01D
3.9pF(3R9)	±0.1pF(B)	GQM2195C2E3R9BB12D	GQM2195C2A3R9BB01D
	±0.25pF(C)	GQM2195C2E3R9CB12D	GQM2195C2A3R9CB01D
4.0pF(4R0)	±0.1pF(B)	GQM2195C2E4R0BB12D	GQM2195C2A4R0BB01D
	±0.25pF(C)	GQM2195C2E4R0CB12D	GQM2195C2A4R0CB01D
4.3pF(4R3)	±0.1pF(B)	GQM2195C2E4R3BB12D	GQM2195C2A4R3BB01D
	±0.25pF(C)	GQM2195C2E4R3CB12D	GQM2195C2A4R3CB01D
4.7pF(4R7)	±0.1pF(B)	GQM2195C2E4R7BB12D	GQM2195C2A4R7BB01D
	±0.25pF(C)	GQM2195C2E4R7CB12D	GQM2195C2A4R7CB01D
5.0pF(5R0)	±0.1pF(B)	GQM2195C2E5R0BB12D	GQM2195C2A5R0BB01D
	±0.25pF(C)	GQM2195C2E5R0CB12D	GQM2195C2A5R0CB01D
5.1pF(5R1)	±0.25pF(C)	GQM2195C2E5R1CB12D	GQM2195C2A5R1CB01D
	±0.5pF(D)	GQM2195C2E5R1DB12D	GQM2195C2A5R1DB01D
5.6pF(5R6)	±0.25pF(C)	GQM2195C2E5R6CB12D	GQM2195C2A5R6CB01D
	±0.5pF(D)	GQM2195C2E5R6DB12D	GQM2195C2A5R6DB01D
6.0pF(6R0)	±0.25pF(C)	GQM2195C2E6R0CB12D	GQM2195C2A6R0CB01D
	±0.5pF(D)	GQM2195C2E6R0DB12D	GQM2195C2A6R0DB01D

The part number code is shown in () and Unit is shown in []. < >: EIA [inch] Code

(Part Number) **GQ** **M** **21** **9** **5C** **2E** **R50** **B** **B12** **D**
 ① ② ③ ④ ⑤ ⑥ ⑦ ⑧ ⑨ ⑩

① Product ID
 ② Series
 ⑤ Temperature Characteristics
 ⑥ Capacitance Tolerance

③ Dimension (LxW)
 ⑥ Rated Voltage
 ⑨ Individual Specification Code

④ Dimension (T)
 ⑦ Capacitance
 ⑩ Packaging

Packaging Code in Part Number is a code shows STD 180mm Reel Taping.

Temperature Compensating Type C0G(5C) Characteristics

LxW [mm]		2.0x1.25(21)<0805>		
Rated Volt. [Vdc]		250(2E)	100(2A)	50(1H)
Capacitance	Tolerance	Part Number		
6.2pF(6R2)	±0.25pF(C)	GQM2195C2E6R2CB12D	GQM2195C2A6R2CB01D	
	±0.5pF(D)	GQM2195C2E6R2DB12D	GQM2195C2A6R2DB01D	
6.8pF(6R8)	±0.25pF(C)	GQM2195C2E6R8CB12D	GQM2195C2A6R8CB01D	
	±0.5pF(D)	GQM2195C2E6R8DB12D	GQM2195C2A6R8DB01D	
7.0pF(7R0)	±0.25pF(C)	GQM2195C2E7R0CB12D	GQM2195C2A7R0CB01D	
	±0.5pF(D)	GQM2195C2E7R0DB12D	GQM2195C2A7R0DB01D	
7.5pF(7R5)	±0.25pF(C)	GQM2195C2E7R5CB12D	GQM2195C2A7R5CB01D	
	±0.5pF(D)	GQM2195C2E7R5DB12D	GQM2195C2A7R5DB01D	
8.0pF(8R0)	±0.25pF(C)	GQM2195C2E8R0CB12D	GQM2195C2A8R0CB01D	
	±0.5pF(D)	GQM2195C2E8R0DB12D	GQM2195C2A8R0DB01D	
8.2pF(8R2)	±0.25pF(C)	GQM2195C2E8R2CB12D	GQM2195C2A8R2CB01D	
	±0.5pF(D)	GQM2195C2E8R2DB12D	GQM2195C2A8R2DB01D	
9.0pF(9R0)	±0.25pF(C)	GQM2195C2E9R0CB12D	GQM2195C2A9R0CB01D	
	±0.5pF(D)	GQM2195C2E9R0DB12D	GQM2195C2A9R0DB01D	
9.1pF(9R1)	±0.25pF(C)	GQM2195C2E9R1CB12D	GQM2195C2A9R1CB01D	
	±0.5pF(D)	GQM2195C2E9R1DB12D	GQM2195C2A9R1DB01D	
10pF(100)	±2%(G)	GQM2195C2E100GB12D	GQM2195C2A100GB01D	
	±5%(J)	GQM2195C2E100JB12D	GQM2195C2A100JB01D	
11pF(110)	±2%(G)	GQM2195C2E110GB12D	GQM2195C2A110GB01D	
	±5%(J)	GQM2195C2E110JB12D	GQM2195C2A110JB01D	
12pF(120)	±2%(G)	GQM2195C2E120GB12D	GQM2195C2A120GB01D	
	±5%(J)	GQM2195C2E120JB12D	GQM2195C2A120JB01D	
13pF(130)	±2%(G)	GQM2195C2E130GB12D	GQM2195C2A130GB01D	
	±5%(J)	GQM2195C2E130JB12D	GQM2195C2A130JB01D	
15pF(150)	±2%(G)	GQM2195C2E150GB12D	GQM2195C2A150GB01D	
	±5%(J)	GQM2195C2E150JB12D	GQM2195C2A150JB01D	
16pF(160)	±2%(G)	GQM2195C2E160GB12D	GQM2195C2A160GB01D	
	±5%(J)	GQM2195C2E160JB12D	GQM2195C2A160JB01D	
18pF(180)	±2%(G)	GQM2195C2E180GB12D	GQM2195C2A180GB01D	
	±5%(J)	GQM2195C2E180JB12D	GQM2195C2A180JB01D	
20pF(200)	±2%(G)	GQM2195C2E200GB12D		GQM2195C1H200GB01D
	±5%(J)	GQM2195C2E200JB12D		GQM2195C1H200JB01D
22pF(220)	±2%(G)	GQM2195C2E220GB12D		GQM2195C1H220GB01D
	±5%(J)	GQM2195C2E220JB12D		GQM2195C1H220JB01D
24pF(240)	±2%(G)	GQM2195C2E240GB12D		GQM2195C1H240GB01D
	±5%(J)	GQM2195C2E240JB12D		GQM2195C1H240JB01D
27pF(270)	±2%(G)	GQM2195C2E270GB12D		GQM2195C1H270GB01D
	±5%(J)	GQM2195C2E270JB12D		GQM2195C1H270JB01D
30pF(300)	±2%(G)	GQM2195C2E300GB12D		GQM2195C1H300GB01D
	±5%(J)	GQM2195C2E300JB12D		GQM2195C1H300JB01D
33pF(330)	±2%(G)	GQM2195C2E330GB12D		GQM2195C1H330GB01D
	±5%(J)	GQM2195C2E330JB12D		GQM2195C1H330JB01D
36pF(360)	±2%(G)	GQM2195C2E360GB12D		GQM2195C1H360GB01D
	±5%(J)	GQM2195C2E360JB12D		GQM2195C1H360JB01D
39pF(390)	±2%(G)	GQM2195C2E390GB12D		GQM2195C1H390GB01D
	±5%(J)	GQM2195C2E390JB12D		GQM2195C1H390JB01D

The part number code is shown in () and Unit is shown in []. < >: EIA [inch] Code

Temperature Compensating Type C0G(5C) Characteristics

LxW [mm]		2.0x1.25(21)<0805>	
Rated Volt. [Vdc]		250(2E)	50(1H)
Capacitance	Tolerance	Part Number	
43pF(430)	±2%(G)	GQM2195C2E430GB12D	GQM2195C1H430GB01D
	±5%(J)	GQM2195C2E430JB12D	GQM2195C1H430JB01D
47pF(470)	±2%(G)	GQM2195C2E470GB12D	GQM2195C1H470GB01D
	±5%(J)	GQM2195C2E470JB12D	GQM2195C1H470JB01D
51pF(510)	±2%(G)	GQM2195C2E510GB12D	GQM2195C1H510GB01D
	±5%(J)	GQM2195C2E510JB12D	GQM2195C1H510JB01D
56pF(560)	±2%(G)	GQM2195C2E560GB12D	GQM2195C1H560GB01D
	±5%(J)	GQM2195C2E560JB12D	GQM2195C1H560JB01D
62pF(620)	±2%(G)	GQM2195C2E620GB12D	GQM2195C1H620GB01D
	±5%(J)	GQM2195C2E620JB12D	GQM2195C1H620JB01D
68pF(680)	±2%(G)	GQM2195C2E680GB12D	GQM2195C1H680GB01D
	±5%(J)	GQM2195C2E680JB12D	GQM2195C1H680JB01D
75pF(750)	±2%(G)	GQM2195C2E750GB12D	GQM2195C1H750GB01D
	±5%(J)	GQM2195C2E750JB12D	GQM2195C1H750JB01D
82pF(820)	±2%(G)	GQM2195C2E820GB12D	GQM2195C1H820GB01D
	±5%(J)	GQM2195C2E820JB12D	GQM2195C1H820JB01D
91pF(910)	±2%(G)	GQM2195C2E910GB12D	GQM2195C1H910GB01D
	±5%(J)	GQM2195C2E910JB12D	GQM2195C1H910JB01D
100pF(101)	±2%(G)	GQM2195C2E101GB12D	GQM2195C1H101GB01D
	±5%(J)	GQM2195C2E101JB12D	GQM2195C1H101JB01D

The part number code is shown in () and Unit is shown in [. <->: EIA [inch] Code

5

(Part Number) **GQ** **M** **21** **9** **5C** **2E** **430** **G** **B12** **D**
 ① ② ③ ④ ⑤ ⑥ ⑦ ⑧ ⑨ ⑩

① Product ID ② Series
 ⑤ Temperature Characteristics
 ⑧ Capacitance Tolerance

③ Dimension (LxW)
 ⑥ Rated Voltage
 ⑨ Individual Specification Code

④ Dimension (T)
 ⑦ Capacitance
 ⑩ Packaging

Packaging Code in Part Number is a code shows STD 180mm Reel Taping.

GQM Series Specifications and Test Methods

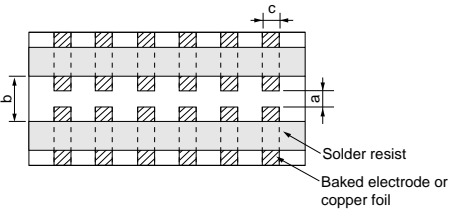
No.	Item	Specifications	Test Method												
1	Operating Temperature	-55 to 125°C	Reference Temperature: 25°C												
2	Rated Voltage	See the previous page.	The rated voltage is defined as the maximum voltage which may be applied continuously to the capacitor. When AC voltage is superimposed on DC voltage, V^{AC} or V^{DC} , whichever is larger, should be maintained within the rated voltage range.												
3	Appearance	No defects or abnormalities	Visual inspection												
4	Dimension	Within the specified dimensions	Using calipers												
5	Dielectric Strength	No defects or abnormalities	No failure should be observed when 300%* of the rated voltage is applied between the terminations for 1 to 5 seconds, provided the charge/discharge current is less than 50mA. *250V only 250%												
6	Insulation Resistance	More than 10,000MΩ	The insulation resistance should be measured with a DC voltage not exceeding the rated voltage at 25°C and 75%RH max. and within 2 minutes of charging.												
7	Capacitance	Within the specified tolerance	The capacitance/Q should be measured at 25°C at the frequency and voltage shown in the table.												
8	Q	30pF min.: $Q \geq 1400$ 30pF max.: $Q \geq 800+20C$ C: Nominal Capacitance (pF)	<table border="1" style="margin-left: auto; margin-right: auto;"> <tr> <td>Frequency</td> <td>1±0.1MHz</td> </tr> <tr> <td>Voltage</td> <td>0.5 to 5Vrms</td> </tr> </table>	Frequency	1±0.1MHz	Voltage	0.5 to 5Vrms								
Frequency	1±0.1MHz														
Voltage	0.5 to 5Vrms														
9	Capacitance Temperature Characteristics	Capacitance Change	Within the specified tolerance (Table A)												
		Temperature Coefficient	Within the specified tolerance (Table A)												
		Capacitance Drift	Within ±0.2% or ±0.05pF (Whichever is larger)												
			<p>The temperature coefficient is determined using the capacitance measured in step 3 as a reference.</p> <p>When cycling the temperature sequentially from step 1 through 5 the capacitance should be within the specified tolerance for the temperature coefficient and capacitance change as in Table A. The capacitance drift is calculated by dividing the differences between the maximum and minimum measured values in the steps 1, 3 and 5 by the capacitance value in step 3.</p> <table border="1" style="margin-left: auto; margin-right: auto;"> <thead> <tr> <th>Step</th> <th>Temperature (°C)</th> </tr> </thead> <tbody> <tr> <td>1</td> <td>Reference Temp. ±2</td> </tr> <tr> <td>2</td> <td>-55±3</td> </tr> <tr> <td>3</td> <td>Reference Temp. ±2</td> </tr> <tr> <td>4</td> <td>125±3</td> </tr> <tr> <td>5</td> <td>Reference Temp. ±2</td> </tr> </tbody> </table>	Step	Temperature (°C)	1	Reference Temp. ±2	2	-55±3	3	Reference Temp. ±2	4	125±3	5	Reference Temp. ±2
Step	Temperature (°C)														
1	Reference Temp. ±2														
2	-55±3														
3	Reference Temp. ±2														
4	125±3														
5	Reference Temp. ±2														
10	Adhesive Strength of Termination	No removal of the terminations or other defect should occur.	<p>Solder the capacitor to the test jig (glass epoxy board) shown in Fig. 1 using a eutectic solder. Then apply 10N* force in parallel with the test jig for 10±1 sec.</p> <p>The soldering should be done either with an iron or using the reflow method and should be conducted with care so that the soldering is uniform and free of defects such as heat shock.</p> <p style="text-align: right;">*5N (GQM188)</p> <table border="1" style="margin-left: auto; margin-right: auto;"> <thead> <tr> <th>Type</th> <th>a</th> <th>b</th> <th>c</th> </tr> </thead> <tbody> <tr> <td>GQM18</td> <td>1.0</td> <td>3.0</td> <td>1.2</td> </tr> <tr> <td>GQM21</td> <td>1.2</td> <td>4.0</td> <td>1.65</td> </tr> </tbody> </table> <p style="text-align: right;">(in mm)</p>	Type	a	b	c	GQM18	1.0	3.0	1.2	GQM21	1.2	4.0	1.65
		Type		a	b	c									
GQM18	1.0	3.0	1.2												
GQM21	1.2	4.0	1.65												
		Fig. 1													
11	Vibration Resistance	Appearance	No defects or abnormalities												
		Capacitance	Within the specified tolerance												
		Q	30pF min.: $Q \geq 1400$ 30pF max.: $Q \geq 800+20C$ C: Nominal Capacitance (pF)												
			<p>Solder the capacitor to the test jig (glass epoxy board) in the same manner and under the same conditions as (10).</p> <p>The capacitor should be subjected to a simple harmonic motion having a total amplitude of 1.5mm, the frequency being varied uniformly between the approximate limits of 10 and 55Hz. The frequency range, from 10 to 55Hz and return to 10Hz, should be traversed in approximately 1 minute.</p> <p>This motion should be applied for a period of 2 hours in each of 3 mutually perpendicular directions (total of 6 hours).</p>												

Continued on the following page.

5

GQM Series Specifications and Test Methods

Continued from the preceding page.

5

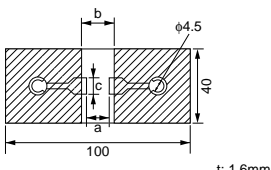
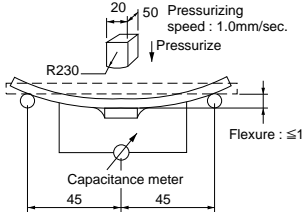
No.	Item	Specifications	Test Method															
12	Appearance	No marking defects	Solder the capacitor on the test jig (glass epoxy board) shown in Fig. 2 using a eutectic solder. Then apply a force in the direction shown in Fig. 3. The soldering should be done by the reflow method and should be conducted with care so that the soldering is uniform and free of defects such as heat shock.															
	Capacitance Change	Within $\pm 5\%$ or $\pm 0.5\text{pF}$ (Whichever is larger)																
		 <table border="1" style="margin: 0 auto; border-collapse: collapse;"> <thead> <tr> <th>Type</th> <th>a</th> <th>b</th> <th>c</th> </tr> </thead> <tbody> <tr> <td>GQM18</td> <td>1.0</td> <td>3.0</td> <td>1.2</td> </tr> <tr> <td>GQM21</td> <td>1.2</td> <td>4.0</td> <td>1.65</td> </tr> </tbody> </table> <p style="text-align: right;">(in mm)</p>	Type	a	b	c	GQM18	1.0	3.0	1.2	GQM21	1.2	4.0	1.65				
Type	a	b	c															
GQM18	1.0	3.0	1.2															
GQM21	1.2	4.0	1.65															
13	Solderability of Termination	75% of the terminations are to be soldered evenly and continuously.	Immerse the capacitor in a solution of ethanol (JIS-K-8101) and rosin (JIS-K-5902) (25% rosin in weight proportion). Preheat at 80 to 120°C for 10 to 30 seconds. After preheating, immerse in eutectic solder solution for 2 ± 0.5 seconds at $230\pm 5^\circ\text{C}$ or Sn-3.0Ag-0.5Cu solder solution for 2 ± 0.5 seconds at $245\pm 5^\circ\text{C}$.															
14	Resistance to Soldering Heat		The measured and observed characteristics should satisfy the specifications in the following table. Preheat the capacitor at 120 to 150°C for 1 minute. Immerse the capacitor in a eutectic solder or Sn-3.0Ag-0.5Cu solder solution at $270\pm 5^\circ\text{C}$ for 10 ± 0.5 seconds. Let sit at room temperature for 24 ± 2 hours.															
	Appearance	No marking defects																
	Capacitance Change	Within $\pm 2.5\%$ or $\pm 0.25\text{pF}$ (Whichever is larger)																
	Q	30pF min.: $Q\geq 1400$ 30pF max.: $Q\geq 800+20C$ C: Nominal Capacitance (pF)																
	I.R.	More than 10,000MΩ																
Dielectric Strength	No failure																	
15	Temperature Cycle		The measured and observed characteristics should satisfy the specifications in the following table. Fix the capacitor to the supporting jig in the same manner and under the same conditions as (10). Perform the five cycles according to the four heat treatments listed in the following table. Let sit for 24 ± 2 hours at room temperature, then measure.															
	Appearance	No marking defects																
	Capacitance Change	Within $\pm 2.5\%$ or $\pm 0.25\text{pF}$ (Whichever is larger)																
	Q	30pF min.: $Q\geq 1400$ 30pF max.: $Q\geq 800+20C$ C: Nominal Capacitance (pF)																
	I.R.	More than 10,000MΩ																
Dielectric Strength	No failure																	
			<table border="1" style="margin: 0 auto; border-collapse: collapse;"> <thead> <tr> <th>Step</th> <th>1</th> <th>2</th> <th>3</th> <th>4</th> </tr> </thead> <tbody> <tr> <td>Temp. (°C)</td> <td>Min. Operating Temp. +0/-3</td> <td>Room Temp.</td> <td>Max. Operating Temp. +3/-0</td> <td>Room Temp.</td> </tr> <tr> <td>Time (min.)</td> <td>30±3</td> <td>2 to 3</td> <td>30±3</td> <td>2 to 3</td> </tr> </tbody> </table>	Step	1	2	3	4	Temp. (°C)	Min. Operating Temp. +0/-3	Room Temp.	Max. Operating Temp. +3/-0	Room Temp.	Time (min.)	30±3	2 to 3	30±3	2 to 3
Step	1	2	3	4														
Temp. (°C)	Min. Operating Temp. +0/-3	Room Temp.	Max. Operating Temp. +3/-0	Room Temp.														
Time (min.)	30±3	2 to 3	30±3	2 to 3														
16	Humidity Steady State		The measured and observed characteristics should satisfy the specifications in the following table. Let the capacitor sit at $40\pm 2^\circ\text{C}$ and 90 to 95% humidity for 500 ± 12 hours. Remove and let sit for 24 ± 2 hours (temperature compensating type) at room temperature, then measure.															
	Appearance	No marking defects																
	Capacitance Change	Within $\pm 5\%$ or $\pm 0.5\text{pF}$ (Whichever is larger)																
	Q	30pF min.: $Q\geq 350$ 10pF and over, 30pF and below: $Q\geq 275+5C/2$ 10pF max.: $Q\geq 200+10C$ C: Nominal Capacitance (pF)																
I.R.	More than 1,000MΩ																	

Continued on the following page.

GQM Series Specifications and Test Methods

Continued from the preceding page.

No.	Item	Specifications	Test Method	
17	Humidity Load	The measured and observed characteristics should satisfy the specifications in the following table.	Apply the rated voltage at 40±2°C and 90 to 95% humidity for 500±12 hours. Remove and let sit for 24±2 hours at room temperature then measure. The charge/discharge current is less than 50mA.	
		Appearance		No marking defects
		Capacitance Change		Within ±7.5% or ±0.75pF (Whichever is larger)
		Q		30pF min.: $Q \geq 200$ 30pF max.: $Q \geq 100 + 10C/3$ C: Nominal Capacitance (pF)
	I.R.	More than 500MΩ		
18	High Temperature Load	The measured and observed characteristics should satisfy the specifications in the following table.	Apply 200% of the rated voltage for 1000±12 hours at the maximum operating temperature ±3°C. Let sit for 24±2 hours (temperature compensating type) at room temperature, then measure. The charge/discharge current is less than 50mA.	
		Appearance		No marking defects
		Capacitance Change		Within ±3% or ±0.3pF (Whichever is larger)
		Q		30pF min.: $Q \geq 350$ 10pF and over, 30pF and below: $Q \geq 275 + 5C/2$ 10pF max.: $Q \geq 200 + 10C$ C: Nominal Capacitance (pF)
	I.R.	More than 1,000MΩ		

5

Table A

Char.	Nominal Values (ppm/°C) *1	Capacitance Change from 25°C (%)					
		-55°C		-30°C		-10°C	
		Max.	Min.	Max.	Min.	Max.	Min.
5C	0±30	0.58	-0.24	0.40	-0.17	0.25	-0.11

*1: Nominal values denote the temperature coefficient within a range of 25 to 125°C.

GQM Series Data

■ Q - Frequency Characteristics

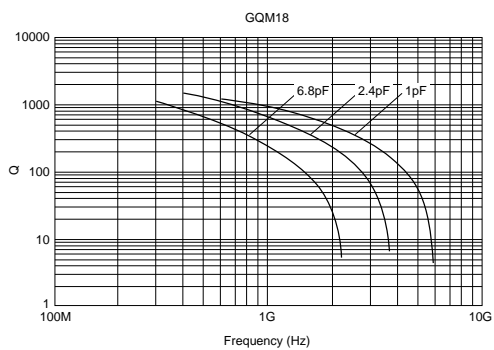

■ Resonant Frequency - Capacitance

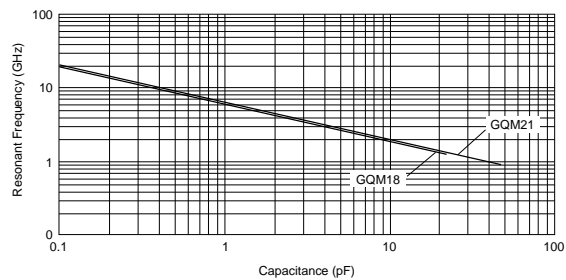

5

Chip Monolithic Ceramic Capacitors



High Frequency Type ERB Series

■ Features (ERB Series)

1. Negligible inductance is achieved by its monolithic structure so the series can be used at frequencies above 1GHz.
2. Nickel barriered terminations of ERB series improve solderability and decrease solder leaching.
3. ERB18/21 series are designed for both flow and reflow soldering and ERB32 series are designed for reflow soldering.

■ Applications

High frequency and high-power circuits

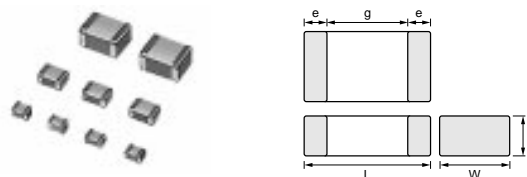

Part Number	Dimensions (mm)				
	L	W	T max.	e min.	g min.
ERB188	1.6±0.1	0.8±0.1	0.9	0.2	0.5
ERB21B	2.0±0.3	1.25±0.3	1.35	0.25	0.7
ERB32Q	3.2±0.3	2.5±0.3	1.7	0.3	1.0

6

Capacitance Table

Temperature Compensating Type C0G(5C) Characteristics

8 ex.8: T Dimension [mm]

Capacitance	Rated Voltage [Vdc]	COG(5C)										
		TC		1.6x0.8 (18) <0603>			2.0x1.25 (21) <0805>			3.2x2.5 (32) <1210>		
		LxW [mm]		250 (2E)	250 (2E)	100 (2A)	50 (1H)	500 (2H)	300 (YD)	250 (2E)	100 (2A)	50 (1H)
0.50pF(R50)		8	B									
0.75pF(R75)		8	B									
1.0pF(1R0)		8	B									
1.1pF(1R1)		8	B									
1.2pF(1R2)		8	B									
1.3pF(1R3)		8	B									
1.5pF(1R5)		8	B									
1.6pF(1R6)		8	B									
1.8pF(1R8)		8	B									
2.0pF(2R0)		8	B									
2.2pF(2R2)		8	B									
2.4pF(2R4)		8	B									
2.7pF(2R7)		8	B									
3.0pF(3R0)		8	B									
3.3pF(3R3)		8	B					Q				
3.6pF(3R6)		8	B					Q				
3.9pF(3R9)		8	B					Q				
4.0pF(4R0)		8	B					Q				
4.3pF(4R3)		8	B					Q				
4.7pF(4R7)		8	B					Q				
5.0pF(5R0)		8	B					Q				
5.1pF(5R1)		8	B					Q				
5.6pF(5R6)		8	B					Q				
6.0pF(6R0)		8	B					Q				
6.2pF(6R2)		8	B					Q				
6.8pF(6R8)		8	B					Q				
7.0pF(7R0)		8	B					Q				
7.5pF(7R5)		8	B					Q				
8.0pF(8R0)		8	B					Q				
8.2pF(8R2)		8	B					Q				
9.0pF(9R0)		8	B					Q				
9.1pF(9R1)		8	B					Q				
10pF(100)		8	B					Q				
11pF(110)		8	B					Q				
12pF(120)		8	B					Q				
13pF(130)		8	B					Q				
15pF(150)		8	B					Q				
16pF(160)		8	B					Q				
18pF(180)		8	B					Q				
20pF(200)		8	B					Q				
22pF(220)		8	B					Q				
24pF(240)		8	B					Q				
27pF(270)		8	B					Q				
30pF(300)		8	B					Q				
33pF(330)		8	B					Q				
36pF(360)		8	B					Q				
39pF(390)		8	B					Q				
43pF(430)		8	B					Q				

Capacitance	Rated Voltage [Vdc]	COG(5C)										
		TC		1.6x0.8 (18) <0603>			2.0x1.25 (21) <0805>			3.2x2.5 (32) <1210>		
		LxW [mm]		250 (2E)	250 (2E)	100 (2A)	50 (1H)	500 (2H)	300 (YD)	250 (2E)	100 (2A)	50 (1H)
47pF(470)		8	B					Q				
51pF(510)		8	B					Q				
56pF(560)		8	B					Q				
62pF(620)		8	B					Q				
68pF(680)		8	B					Q				
75pF(750)		8	B					Q				
82pF(820)		8	B					Q				
91pF(910)		8	B					Q				
100pF(101)		8	B					Q				
110pF(111)					B			Q				
120pF(121)					B			Q				
130pF(131)					B			Q	Q			
150pF(151)						B		Q	Q			
160pF(161)							B	Q	Q	Q		
180pF(181)								Q	Q	Q	Q	
200pF(201)								Q	Q	Q	Q	
220pF(221)								Q	Q	Q	Q	
240pF(241)								Q		Q	Q	Q
270pF(271)								Q		Q	Q	Q
300pF(301)								Q		Q	Q	Q
330pF(331)								Q		Q	Q	Q
360pF(361)								Q		Q	Q	Q
390pF(391)								Q		Q	Q	Q
430pF(431)								Q		Q	Q	Q
470pF(471)								Q		Q	Q	Q
510pF(511)								Q		Q	Q	Q
560pF(561)								Q		Q	Q	Q
620pF(621)								Q		Q	Q	Q
680pF(681)								Q		Q	Q	Q
750pF(751)								Q		Q	Q	Q
820pF(821)								Q		Q	Q	Q
910pF(911)								Q		Q	Q	Q
1000pF(102)								Q		Q	Q	Q

The part number code is shown in () and Unit is shown in []. < >: EIA [inch] Code

Temperature Compensating Type C0G(5C) Characteristics

LxW [mm]		1.6x0.8(18)<0603>		2.0x1.25(21)<0805>	
Rated Volt. [Vdc]		250(2E)		250(2E)	
Capacitance	Tolerance	Part Number			
0.50pF(R50)	±0.1pF(B)	ERB1885C2ER50BDX1D	ERB21B5C2ER50BDX1L		
	±0.25pF(C)	ERB1885C2ER50CDX1D	ERB21B5C2ER50CDX1L		
0.75pF(R75)	±0.1pF(B)	ERB1885C2ER75BDX1D	ERB21B5C2ER75BDX1L		
	±0.25pF(C)	ERB1885C2ER75CDX1D	ERB21B5C2ER75CDX1L		
1.0pF(1R0)	±0.1pF(B)	ERB1885C2E1R0BDX1D	ERB21B5C2E1R0BDX1L		
	±0.25pF(C)	ERB1885C2E1R0CDX1D	ERB21B5C2E1R0CDX1L		
1.1pF(1R1)	±0.1pF(B)	ERB1885C2E1R1BDX1D	ERB21B5C2E1R1BDX1L		
	±0.25pF(C)	ERB1885C2E1R1CDX1D	ERB21B5C2E1R1CDX1L		
1.2pF(1R2)	±0.1pF(B)	ERB1885C2E1R2BDX1D	ERB21B5C2E1R2BDX1L		
	±0.25pF(C)	ERB1885C2E1R2CDX1D	ERB21B5C2E1R2CDX1L		
1.3pF(1R3)	±0.1pF(B)	ERB1885C2E1R3BDX1D	ERB21B5C2E1R3BDX1L		
	±0.25pF(C)	ERB1885C2E1R3CDX1D	ERB21B5C2E1R3CDX1L		
1.5pF(1R5)	±0.1pF(B)	ERB1885C2E1R5BDX1D	ERB21B5C2E1R5BDX1L		
	±0.25pF(C)	ERB1885C2E1R5CDX1D	ERB21B5C2E1R5CDX1L		
1.6pF(1R6)	±0.1pF(B)	ERB1885C2E1R6BDX1D	ERB21B5C2E1R6BDX1L		
	±0.25pF(C)	ERB1885C2E1R6CDX1D	ERB21B5C2E1R6CDX1L		
1.8pF(1R8)	±0.1pF(B)	ERB1885C2E1R8BDX1D	ERB21B5C2E1R8BDX1L		
	±0.25pF(C)	ERB1885C2E1R8CDX1D	ERB21B5C2E1R8CDX1L		
2.0pF(2R0)	±0.1pF(B)	ERB1885C2E2R0BDX1D	ERB21B5C2E2R0BDX1L		
	±0.25pF(C)	ERB1885C2E2R0CDX1D	ERB21B5C2E2R0CDX1L		
2.2pF(2R2)	±0.1pF(B)	ERB1885C2E2R2BDX1D	ERB21B5C2E2R2BDX1L		
	±0.25pF(C)	ERB1885C2E2R2CDX1D	ERB21B5C2E2R2CDX1L		
2.4pF(2R4)	±0.1pF(B)	ERB1885C2E2R4BDX1D	ERB21B5C2E2R4BDX1L		
	±0.25pF(C)	ERB1885C2E2R4CDX1D	ERB21B5C2E2R4CDX1L		
2.7pF(2R7)	±0.1pF(B)	ERB1885C2E2R7BDX1D	ERB21B5C2E2R7BDX1L		
	±0.25pF(C)	ERB1885C2E2R7CDX1D	ERB21B5C2E2R7CDX1L		
3.0pF(3R0)	±0.1pF(B)	ERB1885C2E3R0BDX1D	ERB21B5C2E3R0BDX1L		
	±0.25pF(C)	ERB1885C2E3R0CDX1D	ERB21B5C2E3R0CDX1L		
3.3pF(3R3)	±0.1pF(B)	ERB1885C2E3R3BDX1D	ERB21B5C2E3R3BDX1L		
	±0.25pF(C)	ERB1885C2E3R3CDX1D	ERB21B5C2E3R3CDX1L		
3.6pF(3R6)	±0.1pF(B)	ERB1885C2E3R6BDX1D	ERB21B5C2E3R6BDX1L		
	±0.25pF(C)	ERB1885C2E3R6CDX1D	ERB21B5C2E3R6CDX1L		
3.9pF(3R9)	±0.1pF(B)	ERB1885C2E3R9BDX1D	ERB21B5C2E3R9BDX1L		
	±0.25pF(C)	ERB1885C2E3R9CDX1D	ERB21B5C2E3R9CDX1L		
4.0pF(4R0)	±0.1pF(B)	ERB1885C2E4R0BDX1D	ERB21B5C2E4R0BDX1L		
	±0.25pF(C)	ERB1885C2E4R0CDX1D	ERB21B5C2E4R0CDX1L		
4.3pF(4R3)	±0.1pF(B)	ERB1885C2E4R3BDX1D	ERB21B5C2E4R3BDX1L		
	±0.25pF(C)	ERB1885C2E4R3CDX1D	ERB21B5C2E4R3CDX1L		
4.7pF(4R7)	±0.1pF(B)	ERB1885C2E4R7BDX1D	ERB21B5C2E4R7BDX1L		
	±0.25pF(C)	ERB1885C2E4R7CDX1D	ERB21B5C2E4R7CDX1L		
5.0pF(5R0)	±0.1pF(B)	ERB1885C2E5R0BDX1D	ERB21B5C2E5R0BDX1L		
	±0.25pF(C)	ERB1885C2E5R0CDX1D	ERB21B5C2E5R0CDX1L		
5.1pF(5R1)	±0.1pF(B)	ERB1885C2E5R1BDX1D	ERB21B5C2E5R1BDX1L		
	±0.25pF(C)	ERB1885C2E5R1CDX1D	ERB21B5C2E5R1CDX1L		
	±0.5pF(D)	ERB1885C2E5R1DDX1D	ERB21B5C2E5R1DDX1L		
5.6pF(5R6)	±0.1pF(B)	ERB1885C2E5R6BDX1D	ERB21B5C2E5R6BDX1L		
	±0.25pF(C)	ERB1885C2E5R6CDX1D	ERB21B5C2E5R6CDX1L		
	±0.5pF(D)	ERB1885C2E5R6DDX1D	ERB21B5C2E5R6DDX1L		
6.0pF(6R0)	±0.1pF(B)	ERB1885C2E6R0BDX1D	ERB21B5C2E6R0BDX1L		
	±0.25pF(C)	ERB1885C2E6R0CDX1D	ERB21B5C2E6R0CDX1L		
	±0.5pF(D)	ERB1885C2E6R0DDX1D	ERB21B5C2E6R0DDX1L		

The part number code is shown in () and Unit is shown in []. <->: EIA [inch] Code

(Part Number) **ER** **B** **18** **8** **5C** **2E** **R50** **B** **DX1** **D** **1** **2** **3** **4** **5** **6** **7** **8** **9** **10**

①Product ID ②Series ③Dimension (LxW) ④Dimension (T)
 ⑤Temperature Characteristics ⑥Rated Voltage ⑦Capacitance
 ⑧Capacitance Tolerance ⑨Individual Specification Code ⑩Packaging

Packaging Code in Part Number is a code shows STD 180mm Reel Taping.

Temperature Compensating Type C0G(5C) Characteristics

LxW [mm]		1.6x0.8(18)<0603>	2.0x1.25(21)<0805>
Rated Volt. [Vdc]		250(2E)	250(2E)
Capacitance	Tolerance	Part Number	
6.2pF(6R2)	±0.1pF(B)	ERB1885C2E6R2BDX1D	ERB21B5C2E6R2BDX1L
	±0.25pF(C)	ERB1885C2E6R2CDX1D	ERB21B5C2E6R2CDX1L
	±0.5pF(D)	ERB1885C2E6R2DDX1D	ERB21B5C2E6R2DDX1L
6.8pF(6R8)	±0.1pF(B)	ERB1885C2E6R8BDX1D	ERB21B5C2E6R8BDX1L
	±0.25pF(C)	ERB1885C2E6R8CDX1D	ERB21B5C2E6R8CDX1L
	±0.5pF(D)	ERB1885C2E6R8DDX1D	ERB21B5C2E6R8DDX1L
7.0pF(7R0)	±0.1pF(B)	ERB1885C2E7R0BDX5D	ERB21B5C2E7R0BDX1L
	±0.25pF(C)	ERB1885C2E7R0CDX5D	ERB21B5C2E7R0CDX1L
	±0.5pF(D)	ERB1885C2E7R0DDX5D	ERB21B5C2E7R0DDX1L
7.5pF(7R5)	±0.1pF(B)	ERB1885C2E7R5BDX5D	ERB21B5C2E7R5BDX1L
	±0.25pF(C)	ERB1885C2E7R5CDX5D	ERB21B5C2E7R5CDX1L
	±0.5pF(D)	ERB1885C2E7R5DDX5D	ERB21B5C2E7R5DDX1L
8.0pF(8R0)	±0.1pF(B)	ERB1885C2E8R0BDX5D	ERB21B5C2E8R0BDX1L
	±0.25pF(C)	ERB1885C2E8R0CDX5D	ERB21B5C2E8R0CDX1L
	±0.5pF(D)	ERB1885C2E8R0DDX5D	ERB21B5C2E8R0DDX1L
8.2pF(8R2)	±0.1pF(B)	ERB1885C2E8R2BDX5D	ERB21B5C2E8R2BDX1L
	±0.25pF(C)	ERB1885C2E8R2CDX5D	ERB21B5C2E8R2CDX1L
	±0.5pF(D)	ERB1885C2E8R2DDX5D	ERB21B5C2E8R2DDX1L
9.0pF(9R0)	±0.1pF(B)	ERB1885C2E9R0BDX5D	ERB21B5C2E9R0BDX1L
	±0.25pF(C)	ERB1885C2E9R0CDX5D	ERB21B5C2E9R0CDX1L
	±0.5pF(D)	ERB1885C2E9R0DDX5D	ERB21B5C2E9R0DDX1L
9.1pF(9R1)	±0.1pF(B)	ERB1885C2E9R1BDX5D	ERB21B5C2E9R1BDX1L
	±0.25pF(C)	ERB1885C2E9R1CDX5D	ERB21B5C2E9R1CDX1L
	±0.5pF(D)	ERB1885C2E9R1DDX5D	ERB21B5C2E9R1DDX1L
10pF(100)	±2%(G)	ERB1885C2E100GDX5D	ERB21B5C2E100GDX1L
	±5%(J)	ERB1885C2E100JDX5D	ERB21B5C2E100JDX1L
11pF(110)	±2%(G)	ERB1885C2E110GDX5D	ERB21B5C2E110GDX1L
	±5%(J)	ERB1885C2E110JDX5D	ERB21B5C2E110JDX1L
12pF(120)	±2%(G)	ERB1885C2E120GDX5D	ERB21B5C2E120GDX1L
	±5%(J)	ERB1885C2E120JDX5D	ERB21B5C2E120JDX1L
13pF(130)	±2%(G)	ERB1885C2E130GDX5D	ERB21B5C2E130GDX1L
	±5%(J)	ERB1885C2E130JDX5D	ERB21B5C2E130JDX1L
15pF(150)	±2%(G)	ERB1885C2E150GDX5D	ERB21B5C2E150GDX1L
	±5%(J)	ERB1885C2E150JDX5D	ERB21B5C2E150JDX1L
16pF(160)	±2%(G)	ERB1885C2E160GDX5D	ERB21B5C2E160GDX1L
	±5%(J)	ERB1885C2E160JDX5D	ERB21B5C2E160JDX1L
18pF(180)	±2%(G)	ERB1885C2E180GDX5D	ERB21B5C2E180GDX1L
	±5%(J)	ERB1885C2E180JDX5D	ERB21B5C2E180JDX1L
20pF(200)	±2%(G)	ERB1885C2E200GDX5D	ERB21B5C2E200GDX1L
	±5%(J)	ERB1885C2E200JDX5D	ERB21B5C2E200JDX1L
22pF(220)	±2%(G)	ERB1885C2E220GDX5D	ERB21B5C2E220GDX1L
	±5%(J)	ERB1885C2E220JDX5D	ERB21B5C2E220JDX1L
24pF(240)	±2%(G)	ERB1885C2E240GDX5D	ERB21B5C2E240GDX1L
	±5%(J)	ERB1885C2E240JDX5D	ERB21B5C2E240JDX1L
27pF(270)	±2%(G)	ERB1885C2E270GDX5D	ERB21B5C2E270GDX1L
	±5%(J)	ERB1885C2E270JDX5D	ERB21B5C2E270JDX1L
30pF(300)	±2%(G)	ERB1885C2E300GDX5D	ERB21B5C2E300GDX1L
	±5%(J)	ERB1885C2E300JDX5D	ERB21B5C2E300JDX1L
33pF(330)	±2%(G)	ERB1885C2E330GDX5D	ERB21B5C2E330GDX1L
	±5%(J)	ERB1885C2E330JDX5D	ERB21B5C2E330JDX1L

The part number code is shown in () and Unit is shown in []. < >: EIA [inch] Code

(Part Number) ER B 18 8 5C 2E 6R2 B DX1 D
 ① Product ID ② Series ③ Dimension (LxW) ④ Dimension (T)
 ⑤ Temperature Characteristics ⑥ Rated Voltage ⑦ Capacitance
 ⑧ Capacitance Tolerance ⑨ Individual Specification Code ⑩ Packaging

Packaging Code in Part Number is a code shows STD 180mm Reel Taping.

Temperature Compensating Type C0G(5C) Characteristics

LxW [mm]		1.6x0.8(18)<0603>		2.0x1.25(21)<0805>	
Rated Volt. [Vdc]		250(2E)		250(2E)	100(2A)
Capacitance	Tolerance	Part Number			
36pF(360)	±2%(G)	ERB1885C2E360GDX5D	ERB21B5C2E360GDX1L		
	±5%(J)	ERB1885C2E360JDX5D	ERB21B5C2E360JDX1L		
39pF(390)	±2%(G)	ERB1885C2E390GDX5D	ERB21B5C2E390GDX1L		
	±5%(J)	ERB1885C2E390JDX5D	ERB21B5C2E390JDX1L		
43pF(430)	±2%(G)	ERB1885C2E430GDX5D	ERB21B5C2E430GDX1L		
	±5%(J)	ERB1885C2E430JDX5D	ERB21B5C2E430JDX1L		
47pF(470)	±2%(G)	ERB1885C2E470GDX5D	ERB21B5C2E470GDX1L		
	±5%(J)	ERB1885C2E470JDX5D	ERB21B5C2E470JDX1L		
51pF(510)	±2%(G)	ERB1885C2E510GDX5D	ERB21B5C2E510GDX1L		
	±5%(J)	ERB1885C2E510JDX5D	ERB21B5C2E510JDX1L		
56pF(560)	±2%(G)	ERB1885C2E560GDX5D	ERB21B5C2E560GDX1L		
	±5%(J)	ERB1885C2E560JDX5D	ERB21B5C2E560JDX1L		
62pF(620)	±2%(G)	ERB1885C2E620GDX5D	ERB21B5C2E620GDX1L		
	±5%(J)	ERB1885C2E620JDX5D	ERB21B5C2E620JDX1L		
68pF(680)	±2%(G)	ERB1885C2E680GDX5D	ERB21B5C2E680GDX1L		
	±5%(J)	ERB1885C2E680JDX5D	ERB21B5C2E680JDX1L		
75pF(750)	±2%(G)	ERB1885C2E750GDX5D	ERB21B5C2E750GDX1L		
	±5%(J)	ERB1885C2E750JDX5D	ERB21B5C2E750JDX1L		
82pF(820)	±2%(G)	ERB1885C2E820GDX5D	ERB21B5C2E820GDX1L		
	±5%(J)	ERB1885C2E820JDX5D	ERB21B5C2E820JDX1L		
91pF(910)	±2%(G)	ERB1885C2E910GDX5D	ERB21B5C2E910GDX1L		
	±5%(J)	ERB1885C2E910JDX5D	ERB21B5C2E910JDX1L		
100pF(101)	±2%(G)	ERB1885C2E101GDX5D	ERB21B5C2E101GDX1L		
	±5%(J)	ERB1885C2E101JDX5D	ERB21B5C2E101JDX1L		
110pF(111)	±2%(G)			ERB21B5C2A111GDX1L	
	±5%(J)			ERB21B5C2A111JDX1L	
120pF(121)	±2%(G)			ERB21B5C2A121GDX1L	
	±5%(J)			ERB21B5C2A121JDX1L	
130pF(131)	±2%(G)			ERB21B5C2A131GDX1L	
	±5%(J)			ERB21B5C2A131JDX1L	
150pF(151)	±2%(G)				ERB21B5C1H151GDX1L
	±5%(J)				ERB21B5C1H151JDX1L
160pF(161)	±2%(G)				ERB21B5C1H161GDX1L
	±5%(J)				ERB21B5C1H161JDX1L

The part number code is shown in () and Unit is shown in []. <->: EIA [inch] Code

Temperature Compensating Type C0G(5C) Characteristics

6

LxW [mm]		3.2x2.5(32)<1210>	
Rated Volt. [Vdc]		500(2H)	
Capacitance	Tolerance	Part Number	
3.3pF(3R3)	±0.1pF(B)	ERB32Q5C2H3R3BDX1L	
	±0.25pF(C)	ERB32Q5C2H3R3CDX1L	
3.6pF(3R6)	±0.1pF(B)	ERB32Q5C2H3R6BDX1L	
	±0.25pF(C)	ERB32Q5C2H3R6CDX1L	
3.9pF(3R9)	±0.1pF(B)	ERB32Q5C2H3R9BDX1L	
	±0.25pF(C)	ERB32Q5C2H3R9CDX1L	
4.0pF(4R0)	±0.1pF(B)	ERB32Q5C2H4R0BDX1L	
	±0.25pF(C)	ERB32Q5C2H4R0CDX1L	
4.3pF(4R3)	±0.1pF(B)	ERB32Q5C2H4R3BDX1L	
	±0.25pF(C)	ERB32Q5C2H4R3CDX1L	
4.7pF(4R7)	±0.1pF(B)	ERB32Q5C2H4R7BDX1L	
	±0.25pF(C)	ERB32Q5C2H4R7CDX1L	
5.0pF(5R0)	±0.1pF(B)	ERB32Q5C2H5R0BDX1L	
	±0.25pF(C)	ERB32Q5C2H5R0CDX1L	
5.1pF(5R1)	±0.1pF(B)	ERB32Q5C2H5R1BDX1L	
	±0.25pF(C)	ERB32Q5C2H5R1CDX1L	
	±0.5pF(D)	ERB32Q5C2H5R1DDX1L	
5.6pF(5R6)	±0.1pF(B)	ERB32Q5C2H5R6BDX1L	
	±0.25pF(C)	ERB32Q5C2H5R6CDX1L	
	±0.5pF(D)	ERB32Q5C2H5R6DDX1L	
6.0pF(6R0)	±0.1pF(B)	ERB32Q5C2H6R0BDX1L	
	±0.25pF(C)	ERB32Q5C2H6R0CDX1L	
	±0.5pF(D)	ERB32Q5C2H6R0DDX1L	
6.2pF(6R2)	±0.1pF(B)	ERB32Q5C2H6R2BDX1L	
	±0.25pF(C)	ERB32Q5C2H6R2CDX1L	
	±0.5pF(D)	ERB32Q5C2H6R2DDX1L	
6.8pF(6R8)	±0.1pF(B)	ERB32Q5C2H6R8BDX1L	
	±0.25pF(C)	ERB32Q5C2H6R8CDX1L	
	±0.5pF(D)	ERB32Q5C2H6R8DDX1L	
7.0pF(7R0)	±0.1pF(B)	ERB32Q5C2H7R0BDX1L	
	±0.25pF(C)	ERB32Q5C2H7R0CDX1L	
	±0.5pF(D)	ERB32Q5C2H7R0DDX1L	
7.5pF(7R5)	±0.1pF(B)	ERB32Q5C2H7R5BDX1L	
	±0.25pF(C)	ERB32Q5C2H7R5CDX1L	
	±0.5pF(D)	ERB32Q5C2H7R5DDX1L	
8.0pF(8R0)	±0.1pF(B)	ERB32Q5C2H8R0BDX1L	
	±0.25pF(C)	ERB32Q5C2H8R0CDX1L	
	±0.5pF(D)	ERB32Q5C2H8R0DDX1L	
8.2pF(8R2)	±0.1pF(B)	ERB32Q5C2H8R2BDX1L	
	±0.25pF(C)	ERB32Q5C2H8R2CDX1L	
	±0.5pF(D)	ERB32Q5C2H8R2DDX1L	
9.0pF(9R0)	±0.1pF(B)	ERB32Q5C2H9R0BDX1L	
	±0.25pF(C)	ERB32Q5C2H9R0CDX1L	
	±0.5pF(D)	ERB32Q5C2H9R0DDX1L	
9.1pF(9R1)	±0.1pF(B)	ERB32Q5C2H9R1BDX1L	
	±0.25pF(C)	ERB32Q5C2H9R1CDX1L	
	±0.5pF(D)	ERB32Q5C2H9R1DDX1L	
10pF(100)	±2%(G)	ERB32Q5C2H100GDX1L	
	±5%(J)	ERB32Q5C2H100JDX1L	

LxW [mm]		3.2x2.5(32)<1210>	
Rated Volt. [Vdc]		500(2H)	
Capacitance	Tolerance	Part Number	
11pF(110)	±2%(G)	ERB32Q5C2H110GDX1L	
	±5%(J)	ERB32Q5C2H110JDX1L	
12pF(120)	±2%(G)	ERB32Q5C2H120GDX1L	
	±5%(J)	ERB32Q5C2H120JDX1L	
13pF(130)	±2%(G)	ERB32Q5C2H130GDX1L	
	±5%(J)	ERB32Q5C2H130JDX1L	
15pF(150)	±2%(G)	ERB32Q5C2H150GDX1L	
	±5%(J)	ERB32Q5C2H150JDX1L	
16pF(160)	±2%(G)	ERB32Q5C2H160GDX1L	
	±5%(J)	ERB32Q5C2H160JDX1L	
18pF(180)	±2%(G)	ERB32Q5C2H180GDX1L	
	±5%(J)	ERB32Q5C2H180JDX1L	
20pF(200)	±2%(G)	ERB32Q5C2H200GDX1L	
	±5%(J)	ERB32Q5C2H200JDX1L	
22pF(220)	±2%(G)	ERB32Q5C2H220GDX1L	
	±5%(J)	ERB32Q5C2H220JDX1L	
24pF(240)	±2%(G)	ERB32Q5C2H240GDX1L	
	±5%(J)	ERB32Q5C2H240JDX1L	
27pF(270)	±2%(G)	ERB32Q5C2H270GDX1L	
	±5%(J)	ERB32Q5C2H270JDX1L	
30pF(300)	±2%(G)	ERB32Q5C2H300GDX1L	
	±5%(J)	ERB32Q5C2H300JDX1L	
33pF(330)	±2%(G)	ERB32Q5C2H330GDX1L	
	±5%(J)	ERB32Q5C2H330JDX1L	
36pF(360)	±2%(G)	ERB32Q5C2H360GDX1L	
	±5%(J)	ERB32Q5C2H360JDX1L	
39pF(390)	±2%(G)	ERB32Q5C2H390GDX1L	
	±5%(J)	ERB32Q5C2H390JDX1L	
43pF(430)	±2%(G)	ERB32Q5C2H430GDX1L	
	±5%(J)	ERB32Q5C2H430JDX1L	
47pF(470)	±2%(G)	ERB32Q5C2H470GDX1L	
	±5%(J)	ERB32Q5C2H470JDX1L	
51pF(510)	±2%(G)	ERB32Q5C2H510GDX1L	
	±5%(J)	ERB32Q5C2H510JDX1L	
56pF(560)	±2%(G)	ERB32Q5C2H560GDX1L	
	±5%(J)	ERB32Q5C2H560JDX1L	
62pF(620)	±2%(G)	ERB32Q5C2H620GDX1L	
	±5%(J)	ERB32Q5C2H620JDX1L	
68pF(680)	±2%(G)	ERB32Q5C2H680GDX1L	
	±5%(J)	ERB32Q5C2H680JDX1L	
75pF(750)	±2%(G)	ERB32Q5C2H750GDX1L	
	±5%(J)	ERB32Q5C2H750JDX1L	
82pF(820)	±2%(G)	ERB32Q5C2H820GDX1L	
	±5%(J)	ERB32Q5C2H820JDX1L	
91pF(910)	±2%(G)	ERB32Q5C2H910GDX1L	
	±5%(J)	ERB32Q5C2H910JDX1L	
100pF(101)	±2%(G)	ERB32Q5C2H101GDX1L	
	±5%(J)	ERB32Q5C2H101JDX1L	

The part number code is shown in () and Unit is shown in []. <->: EIA [inch] Code

(Part Number) ER B 32 Q 5C 2H 3R3 B DX1 L
 ① ② ③ ④ ⑤ ⑥ ⑦ ⑧ ⑨ ⑩

① Product ID ② Series ③ Dimension (LxW) ④ Dimension (T)
 ⑤ Temperature Characteristics ⑥ Rated Voltage ⑦ Capacitance
 ⑧ Capacitance Tolerance ⑨ Individual Specification Code ⑩ Packaging

Packaging Code in Part Number is a code shows STD 180mm Reel Taping.

Temperature Compensating Type C0G(5C) Characteristics

LxW [mm]		3.2x2.5(32)<1210>			
Rated Volt. [Vdc]		500(2H)	300(YD)	250(2E)	100(2A)
Capacitance	Tolerance	Part Number			
110pF(111)	±2%(G)	ERB32Q5C2H111GDX1L			
	±5%(J)	ERB32Q5C2H111JDX1L			
120pF(121)	±2%(G)	ERB32Q5C2H121GDX1L			
	±5%(J)	ERB32Q5C2H121JDX1L			
130pF(131)	±2%(G)		ERB32Q5CYD131GDX1L		
	±5%(J)		ERB32Q5CYD131JDX1L		
150pF(151)	±2%(G)		ERB32Q5CYD151GDX1L		
	±5%(J)		ERB32Q5CYD151JDX1L		
160pF(161)	±2%(G)			ERB32Q5C2E161GDX1L	
	±5%(J)			ERB32Q5C2E161JDX1L	
180pF(181)	±2%(G)			ERB32Q5C2E181GDX1L	
	±5%(J)			ERB32Q5C2E181JDX1L	
200pF(201)	±2%(G)			ERB32Q5C2E201GDX1L	
	±5%(J)			ERB32Q5C2E201JDX1L	
220pF(221)	±2%(G)			ERB32Q5C2E221GDX1L	
	±5%(J)			ERB32Q5C2E221JDX1L	
240pF(241)	±2%(G)				ERB32Q5C2A241GDX1L
	±5%(J)				ERB32Q5C2A241JDX1L
270pF(271)	±2%(G)				ERB32Q5C2A271GDX1L
	±5%(J)				ERB32Q5C2A271JDX1L
300pF(301)	±2%(G)				ERB32Q5C2A301GDX1L
	±5%(J)				ERB32Q5C2A301JDX1L
330pF(331)	±2%(G)				ERB32Q5C2A331GDX1L
	±5%(J)				ERB32Q5C2A331JDX1L
360pF(361)	±2%(G)				ERB32Q5C2A361GDX1L
	±5%(J)				ERB32Q5C2A361JDX1L
390pF(391)	±2%(G)				ERB32Q5C2A391GDX1L
	±5%(J)				ERB32Q5C2A391JDX1L
430pF(431)	±2%(G)				ERB32Q5C2A431GDX1L
	±5%(J)				ERB32Q5C2A431JDX1L
470pF(471)	±2%(G)				ERB32Q5C2A471GDX1L
	±5%(J)				ERB32Q5C2A471JDX1L

LxW [mm]		3.2x2.5(32)<1210>	
Rated Volt. [Vdc]		50(1H)	
Capacitance	Tolerance	Part Number	
510pF(511)	±2%(G)	ERB32Q5C1H511GDX1L	
	±5%(J)	ERB32Q5C1H511JDX1L	
560pF(561)	±2%(G)	ERB32Q5C1H561GDX1L	
	±5%(J)	ERB32Q5C1H561JDX1L	
620pF(621)	±2%(G)	ERB32Q5C1H621GDX1L	
	±5%(J)	ERB32Q5C1H621JDX1L	
680pF(681)	±2%(G)	ERB32Q5C1H681GDX1L	
	±5%(J)	ERB32Q5C1H681JDX1L	
750pF(751)	±2%(G)	ERB32Q5C1H751GDX1L	
	±5%(J)	ERB32Q5C1H751JDX1L	
820pF(821)	±2%(G)	ERB32Q5C1H821GDX1L	
	±5%(J)	ERB32Q5C1H821JDX1L	
910pF(911)	±2%(G)	ERB32Q5C1H911GDX1L	
	±5%(J)	ERB32Q5C1H911JDX1L	
1000pF(102)	±2%(G)	ERB32Q5C1H102GDX1L	
	±5%(J)	ERB32Q5C1H102JDX1L	

The part number code is shown in () and Unit is shown in []. < >: EIA [inch] Code

ERB Series Specifications and Test Methods

6

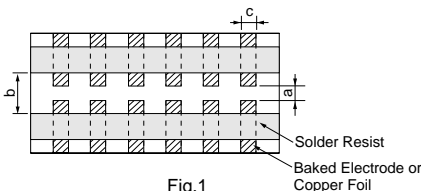
No.	Item	Specifications	Test Method																
1	Operating Temperature Range	-55 to +125°C	Reference Temperature: 25°C																
2	Rated Voltage	See the previous pages.	The rated voltage is defined as the maximum voltage which may be applied continuously to the capacitor. When AC voltage is superimposed on DC voltage, V^{P-P} or V^{O-P} , whichever is larger, should be maintained within the rated voltage range.																
3	Appearance	No defects or abnormalities	Visual inspection																
4	Dimensions	Within the specified dimension	Using calipers																
5	Dielectric Strength	No defects or abnormalities	No failure should be observed when 300%(*) of the rated voltage is applied between the terminations for 1 to 5 seconds, provided the charge/discharge current is less than 50mA. (*) 300V: 250%, 500V: 200%																
6	Insulation Resistance (I.R.)	1,000,000MΩ min. (C≤470pF) 100,000MΩ min. (C>470pF)	The insulation resistance should be measured with a DC voltage not exceeding the rated voltage at 25°C and standard humidity and within 2 minutes of charging.																
7	Capacitance	Within the specified tolerance	The capacitance/Q should be measured at 25°C at the frequency and voltage shown in the table.																
8	Q	$C \leq 220\text{pF} : Q \geq 10,000$ $220\text{pF} < C \leq 470\text{pF} : Q \geq 5,000$ $470\text{pF} < C \leq 1,000\text{pF} : Q \geq 3,000$ C: Nominal Capacitance (pF)	<table border="1"> <tr> <td>Frequency</td> <td>1±0.1MHz</td> </tr> <tr> <td>Voltage</td> <td>1±0.2Vrms</td> </tr> </table>	Frequency	1±0.1MHz	Voltage	1±0.2Vrms												
Frequency	1±0.1MHz																		
Voltage	1±0.2Vrms																		
9	Capacitance Temperature Characteristics	Capacitance Change	The temperature coefficient is determined using the capacitance measured in step 3 as a reference. When cycling the temperature sequentially from step 1 through 5, the capacitance should be within the specified tolerance for the temperature coefficient and capacitance change as Table A. The capacitance drift is calculated by dividing the differences between the maximum and minimum measured values in steps 1, 3 and 5 by the capacitance value in step 3.																
		Temperature Coefficient																	
		Capacitance Drift		Within ±0.2% or ±0.05pF (Whichever is larger)															
10	Adhesive Strength of Termination	No removal of the terminations or other defects should occur.	<p>Solder the capacitor on the test jig (glass epoxy board) shown in Fig. 1 using an eutectic solder. Then apply 10N* force in parallel with the test jig for 10±1sec. The soldering should be done either with an iron or using the reflow method and should be conducted with care so that the soldering is uniform and free of defects such as heat shock.</p> <table border="1"> <thead> <tr> <th>Type</th> <th>a</th> <th>b</th> <th>c</th> </tr> </thead> <tbody> <tr> <td>ERB18</td> <td>1.0</td> <td>3.0</td> <td>1.2</td> </tr> <tr> <td>ERB21</td> <td>1.2</td> <td>4.0</td> <td>1.65</td> </tr> <tr> <td>ERB32</td> <td>2.2</td> <td>5.0</td> <td>2.9</td> </tr> </tbody> </table> <p>(in mm) *5N (ERB188)</p>	Type	a	b	c	ERB18	1.0	3.0	1.2	ERB21	1.2	4.0	1.65	ERB32	2.2	5.0	2.9
		Type		a	b	c													
ERB18	1.0	3.0	1.2																
ERB21	1.2	4.0	1.65																
ERB32	2.2	5.0	2.9																
																			

Continued on the following page. 

ERB Series Specifications and Test Methods

Continued from the preceding page.

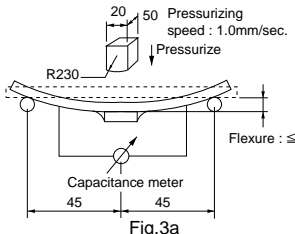
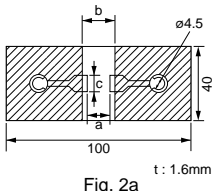
No.	Item	Specifications	Test Method																
11	Appearance	No defects or abnormalities	Solder the capacitor to the test jig (glass epoxy board) in the same manner and under the same conditions as (10). The capacitor should be subjected to a simple harmonic motion having a total amplitude of 1.5mm, the frequency being varied uniformly between the approximate limits of 10 and 55Hz. The frequency range, from 10 to 55Hz and return to 10Hz, should be traversed in approximately 1 minute. This motion should be applied for a period of 2 hours in each of 3 mutually perpendicular directions (total of 6 hours).																
	Capacitance	Within the specified tolerance																	
12	Q	Satisfies the initial value. $C \leq 220\text{pF} : Q \geq 10,000$ $220\text{pF} < C \leq 470\text{pF} : Q \geq 5,000$ $470\text{pF} < C \leq 1,000\text{pF} : Q \geq 3,000$ C: Nominal Capacitance (pF)	Solder the capacitor on the test jig (glass epoxy board) shown in Fig. 2a using an eutectic solder. Then apply a force in the direction shown in Fig. 3a. The soldering should be done by the reflow method and should be conducted with care so that the soldering is uniform and free of defects such as heat shock.																
	Appearance	No marking defects																	
13	Capacitance Change	Within $\pm 5\%$ or $\pm 0.5\text{pF}$ (Whichever is larger)	<table border="1" style="width: 100%; border-collapse: collapse; text-align: center;"> <thead> <tr> <th>Type</th> <th>a</th> <th>b</th> <th>c</th> </tr> </thead> <tbody> <tr> <td>ERB18</td> <td>1.0</td> <td>3.0</td> <td>1.2</td> </tr> <tr> <td>ERB21</td> <td>1.2</td> <td>4.0</td> <td>1.65</td> </tr> <tr> <td>ERB32</td> <td>2.2</td> <td>5.0</td> <td>2.9</td> </tr> </tbody> </table> (in mm)	Type	a	b	c	ERB18	1.0	3.0	1.2	ERB21	1.2	4.0	1.65	ERB32	2.2	5.0	2.9
	Type	a		b	c														
ERB18	1.0	3.0	1.2																
ERB21	1.2	4.0	1.65																
ERB32	2.2	5.0	2.9																
14	Deflection	 Fig. 3a	 Fig. 2a																
	Solderability of Termination	95% of the terminations are to be soldered evenly and continuously.																	
15	Resistance to Soldering Heat	The measured and observed characteristics should satisfy the specifications in the following table.	Immerse the capacitor in a solution of isopropyl alcohol and rosin (25% rosin in weight proportion). Preheat at 80 to 120°C for 10 to 30 seconds. After preheating, immerse in an eutectic solder or Sn-3.0Ag-0.5Cu solder solution for 5±0.5 seconds at 245±5°C. Preheat according to the conditions listed in the table below. Immerse the capacitor in an eutectic solder or Sn-3.0Ag-0.5Cu solder solution at 270±5°C for 10±0.5 seconds. Let sit at room temperature for 24±2 hours.																
	Temperature Cycle	The measured and observed characteristics should satisfy the specifications in the following table.																	
		<table border="1" style="width: 100%; border-collapse: collapse; text-align: center;"> <thead> <tr> <th>Item</th> <th>Specifications</th> </tr> </thead> <tbody> <tr> <td>Appearance</td> <td>No marked defect</td> </tr> <tr> <td>Capacitance Change</td> <td>Within $\pm 2.5\%$ or $\pm 0.25\text{pF}$ (Whichever is larger)</td> </tr> <tr> <td>Q</td> <td> $C \leq 220\text{pF} : Q \geq 10,000$ $220\text{pF} < C \leq 470\text{pF} : Q \geq 5,000$ $470\text{pF} < C \leq 1,000\text{pF} : Q \geq 3,000$ </td> </tr> <tr> <td>Dielectric Strength</td> <td>No failure</td> </tr> </tbody> </table> C: Nominal Capacitance (pF)	Item	Specifications	Appearance	No marked defect	Capacitance Change	Within $\pm 2.5\%$ or $\pm 0.25\text{pF}$ (Whichever is larger)	Q	$C \leq 220\text{pF} : Q \geq 10,000$ $220\text{pF} < C \leq 470\text{pF} : Q \geq 5,000$ $470\text{pF} < C \leq 1,000\text{pF} : Q \geq 3,000$	Dielectric Strength	No failure	<table border="1" style="width: 100%; border-collapse: collapse; text-align: center;"> <thead> <tr> <th>Chip Size</th> <th>Preheat Condition</th> </tr> </thead> <tbody> <tr> <td>2.0×1.25mm max.</td> <td>1minute at 120 to 150°C</td> </tr> <tr> <td>3.2×2.5mm</td> <td>Each 1 minute at 100 to 120°C and then 170 to 200°C</td> </tr> </tbody> </table>	Chip Size	Preheat Condition	2.0×1.25mm max.	1minute at 120 to 150°C	3.2×2.5mm	Each 1 minute at 100 to 120°C and then 170 to 200°C
Item	Specifications																		
Appearance	No marked defect																		
Capacitance Change	Within $\pm 2.5\%$ or $\pm 0.25\text{pF}$ (Whichever is larger)																		
Q	$C \leq 220\text{pF} : Q \geq 10,000$ $220\text{pF} < C \leq 470\text{pF} : Q \geq 5,000$ $470\text{pF} < C \leq 1,000\text{pF} : Q \geq 3,000$																		
Dielectric Strength	No failure																		
Chip Size	Preheat Condition																		
2.0×1.25mm max.	1minute at 120 to 150°C																		
3.2×2.5mm	Each 1 minute at 100 to 120°C and then 170 to 200°C																		
		<table border="1" style="width: 100%; border-collapse: collapse; text-align: center;"> <thead> <tr> <th>Item</th> <th>Specifications</th> </tr> </thead> <tbody> <tr> <td>Appearance</td> <td>No marked defect</td> </tr> <tr> <td>Capacitance Change</td> <td>Within $\pm 5\%$ or $\pm 0.5\text{pF}$ (Whichever is larger)</td> </tr> <tr> <td>Q</td> <td> $C \geq 30\text{pF} : Q \geq 350$ $10\text{pF} \leq C < 30\text{pF} : Q \geq 275 + \frac{C}{10}$ $C < 10\text{pF} : Q \geq 200 + 10C$ </td> </tr> <tr> <td>I.R.</td> <td>1,000MΩ min.</td> </tr> <tr> <td>Dielectric Strength</td> <td>No failure</td> </tr> </tbody> </table> C: Nominal Capacitance (pF)	Item	Specifications	Appearance	No marked defect	Capacitance Change	Within $\pm 5\%$ or $\pm 0.5\text{pF}$ (Whichever is larger)	Q	$C \geq 30\text{pF} : Q \geq 350$ $10\text{pF} \leq C < 30\text{pF} : Q \geq 275 + \frac{C}{10}$ $C < 10\text{pF} : Q \geq 200 + 10C$	I.R.	1,000MΩ min.	Dielectric Strength	No failure	Fix the capacitor to the supporting jig in the same manner and under the same conditions as (10). Perform the five cycles according to the four heat treatments listed in the following table. Let sit for 24±2 hours at room temperature, then measure.				
Item	Specifications																		
Appearance	No marked defect																		
Capacitance Change	Within $\pm 5\%$ or $\pm 0.5\text{pF}$ (Whichever is larger)																		
Q	$C \geq 30\text{pF} : Q \geq 350$ $10\text{pF} \leq C < 30\text{pF} : Q \geq 275 + \frac{C}{10}$ $C < 10\text{pF} : Q \geq 200 + 10C$																		
I.R.	1,000MΩ min.																		
Dielectric Strength	No failure																		
		<table border="1" style="width: 100%; border-collapse: collapse; text-align: center;"> <thead> <tr> <th>Step</th> <th>1</th> <th>2</th> <th>3</th> <th>4</th> </tr> </thead> <tbody> <tr> <td>Temp. (°C)</td> <td>Min. Operating Temp. +0/-3</td> <td>Room Temp.</td> <td>Max. Operating Temp. +3/-0</td> <td>Room Temp.</td> </tr> <tr> <td>Time (min.)</td> <td>30±3</td> <td>5 max.</td> <td>30±3</td> <td>5 max.</td> </tr> </tbody> </table>	Step	1	2	3	4	Temp. (°C)	Min. Operating Temp. +0/-3	Room Temp.	Max. Operating Temp. +3/-0	Room Temp.	Time (min.)	30±3	5 max.	30±3	5 max.		
Step	1	2	3	4															
Temp. (°C)	Min. Operating Temp. +0/-3	Room Temp.	Max. Operating Temp. +3/-0	Room Temp.															
Time (min.)	30±3	5 max.	30±3	5 max.															

Continued on the following page. ↗

ERB Series Specifications and Test Methods

Continued from the preceding page.

No.	Item	Specifications	Test Method										
16	Humidity	<p>The measured and observed characteristics should satisfy the specifications in the following table.</p> <table border="1"> <thead> <tr> <th>Item</th> <th>Specifications</th> </tr> </thead> <tbody> <tr> <td>Appearance</td> <td>No marked defect</td> </tr> <tr> <td>Capacitance Change</td> <td>Within $\pm 5\%$ or $\pm 0.5\text{pF}$ (Whichever is larger) $C \geq 30\text{pF} : Q \geq 350$</td> </tr> <tr> <td>Q</td> <td>$10\text{pF} \leq C < 30\text{pF} : Q \geq 275 + \frac{C}{2}$ $C < 10\text{pF} : Q \geq 200 + 10C$</td> </tr> <tr> <td>I.R.</td> <td>1,000MΩ min.</td> </tr> </tbody> </table> <p style="text-align: right;">C: Nominal Capacitance (pF)</p>	Item	Specifications	Appearance	No marked defect	Capacitance Change	Within $\pm 5\%$ or $\pm 0.5\text{pF}$ (Whichever is larger) $C \geq 30\text{pF} : Q \geq 350$	Q	$10\text{pF} \leq C < 30\text{pF} : Q \geq 275 + \frac{C}{2}$ $C < 10\text{pF} : Q \geq 200 + 10C$	I.R.	1,000M Ω min.	<p>Apply the 24-hour heat (-10 to $+65^\circ\text{C}$) and humidity (80 to 100%) treatment shown below, 10 consecutive times. Remove, let sit for 24 ± 2 hours at room temperature, and measure.</p>
Item	Specifications												
Appearance	No marked defect												
Capacitance Change	Within $\pm 5\%$ or $\pm 0.5\text{pF}$ (Whichever is larger) $C \geq 30\text{pF} : Q \geq 350$												
Q	$10\text{pF} \leq C < 30\text{pF} : Q \geq 275 + \frac{C}{2}$ $C < 10\text{pF} : Q \geq 200 + 10C$												
I.R.	1,000M Ω min.												
17	High Temperature Load	<p>The measured and observed characteristics should satisfy the specifications in the following table.</p> <table border="1"> <thead> <tr> <th>Item</th> <th>Specifications</th> </tr> </thead> <tbody> <tr> <td>Appearance</td> <td>No marked defect</td> </tr> <tr> <td>Capacitance Change</td> <td>Within $\pm 3\%$ or $\pm 0.3\text{pF}$ (Whichever is larger) $C \geq 30\text{pF} : Q \geq 350$</td> </tr> <tr> <td>Q</td> <td>$10\text{pF} \leq C < 30\text{pF} : Q \geq 275 + \frac{C}{2}$ $C < 10\text{pF} : Q \geq 200 + 10C$</td> </tr> <tr> <td>I.R.</td> <td>1,000MΩ min.</td> </tr> </tbody> </table> <p style="text-align: right;">C: Nominal Capacitance (pF)</p>	Item	Specifications	Appearance	No marked defect	Capacitance Change	Within $\pm 3\%$ or $\pm 0.3\text{pF}$ (Whichever is larger) $C \geq 30\text{pF} : Q \geq 350$	Q	$10\text{pF} \leq C < 30\text{pF} : Q \geq 275 + \frac{C}{2}$ $C < 10\text{pF} : Q \geq 200 + 10C$	I.R.	1,000M Ω min.	<p>Apply 200% (500V only 150%) of the rated voltage for $1,000 \pm 12$ hours at $125 \pm 3^\circ\text{C}$. Remove and let sit for 24 ± 2 hours at room temperature, then measure. The charge/discharge current is less than 50mA.</p>
Item	Specifications												
Appearance	No marked defect												
Capacitance Change	Within $\pm 3\%$ or $\pm 0.3\text{pF}$ (Whichever is larger) $C \geq 30\text{pF} : Q \geq 350$												
Q	$10\text{pF} \leq C < 30\text{pF} : Q \geq 275 + \frac{C}{2}$ $C < 10\text{pF} : Q \geq 200 + 10C$												
I.R.	1,000M Ω min.												

Table A-6

Char.	Nominal Values (ppm/ $^\circ\text{C}$) Note 1	Capacitance Change from 25°C (%)					
		-55		-30		-10	
		Max.	Min.	Max.	Min.	Max.	Min.
5C	0 ± 30	0.58	-0.24	0.40	-0.17	0.25	-0.11

Note 1: Nominal values denote the temperature coefficient within a range of 25 to 125°C (for 5C)

ERB Series Data

Q - Frequency Characteristics

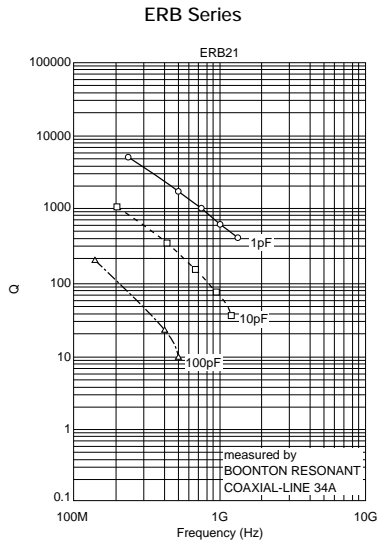

Impedance - Frequency Characteristics

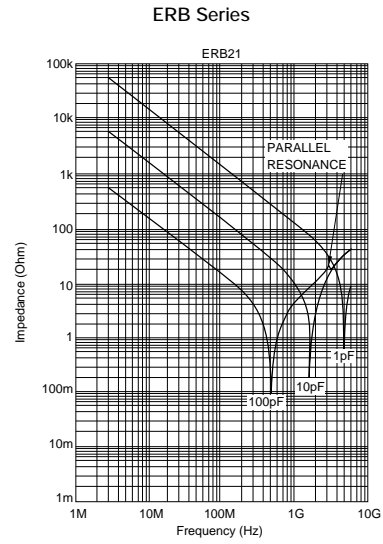

6

ESR - Frequency Characteristics

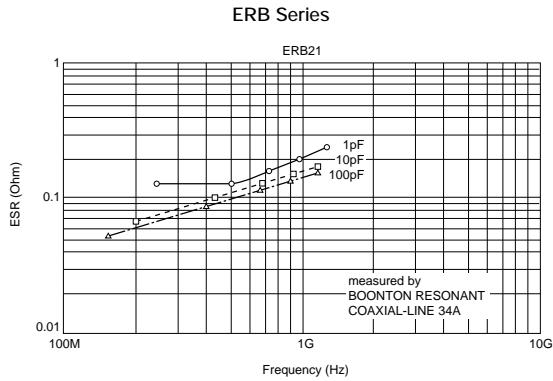

Self Resonant Frequency - Capacitance

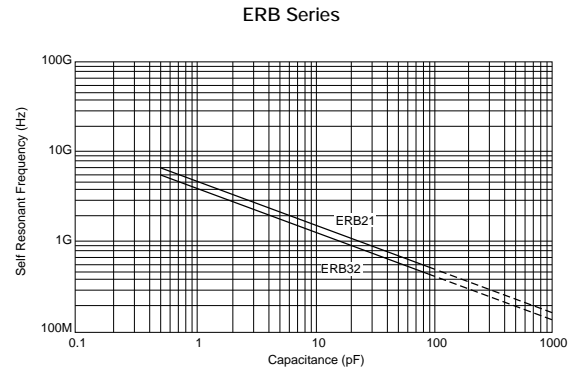

Allowable Voltage - Frequency

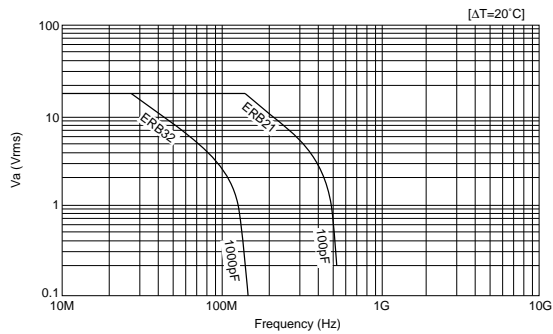

Allowable Current - Frequency

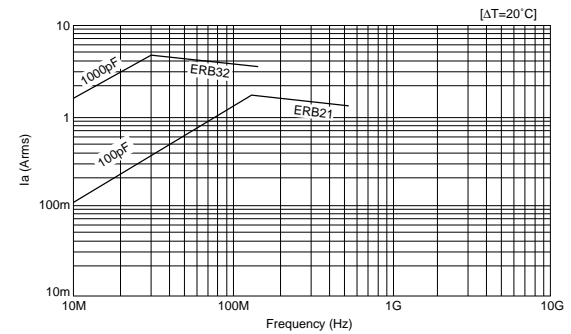

Continued on the following page. ↗

ERB Series Data

Continued from the preceding page.

Allowable Apparent Power - Frequency

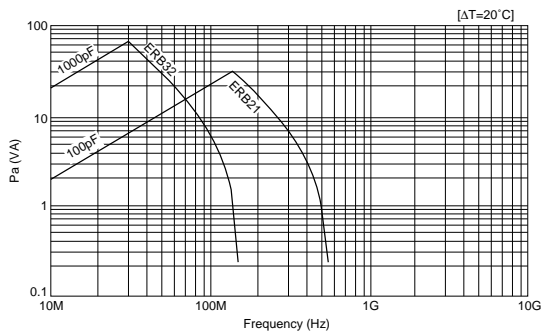

Allowable Effective Power - Frequency

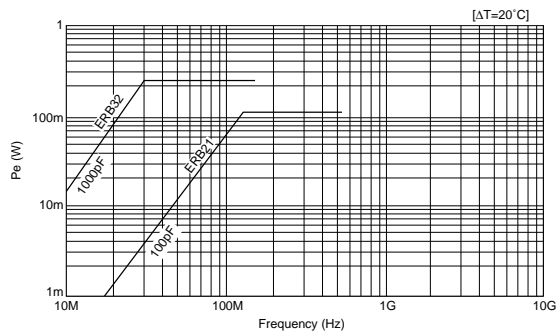

6

Chip Monolithic Ceramic Capacitors



Monolithic Microchip GMA Series

■ Features

1. Better micro wave characteristics
2. Suitable for by-passing
3. High density mounting

■ Applications

1. Optical device for telecommunication
2. IC, IC packaging built-in
3. Measuring equipment

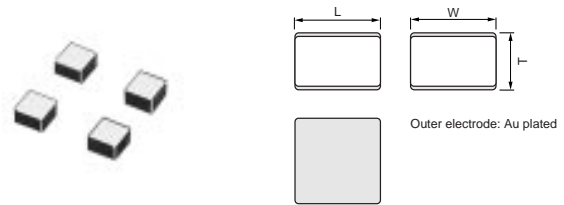

Part Number	Dimensions (mm)		
	L	W	T
GMA0D3	0.38 ±0.05	0.38 ±0.05	0.3 ±0.05
GMA05X	0.5 ±0.05	0.5 ±0.05	0.35 ±0.05
GMA085	0.8 ±0.05	0.8 ±0.05	0.5 ±0.1

Capacitance Table

7

High Dielectric Constant Type X7R(R7)/X5R(R6) Characteristics

X		ex.X: T Dimension [mm]									
LxW [mm]	0.38x0.38 (0D) <015015>	0.5x0.5 (05) <0202>				0.8x0.8 (08) <0303>					
		100 (2A)	25 (1E)	10 (1A)	6.3 (0J)	100 (2A)	25 (1E)	10 (1A)	6.3 (0J)		
Rated Voltage [Vdc]	10 (1A)	100 (2A)	25 (1E)	10 (1A)	6.3 (0J)	100 (2A)	25 (1E)	10 (1A)	6.3 (0J)		
TC	X7R (R7)	X7R (R7)			X5R (R6)	X7R (R7)			X5R (R6)		
100pF(101)		X									
150pF(151)		X									
220pF(221)		X									
330pF(331)		X									
470pF(471)		X									
680pF(681)		X									
1000pF(102)		X									
1500pF(152)			X			5					
2200pF(222)			X			5					
3300pF(332)			X			5					
4700pF(472)			X			5					
6800pF(682)				X		5					
10000pF(103)	3			X			5				
15000pF(153)				X			5				
22000pF(223)				X			5				
33000pF(333)								5			
47000pF(473)								5			
68000pF(683)								5			
0.10μF(104)					X			5			
0.47μF(474)									5		

The part number code is shown in () and Unit is shown in []. < >: EIA [inch] Code

High Dielectric Constant Type X7R(R7)/X5R(R6) Characteristics

LxW [mm]	0.38x0.38(0D)<015015>	
Rated Volt. [Vdc]	10(1A)	
Capacitance	Tolerance	Part Number
1000pF(103)	±20%(M)	GMA0D3R71A103MA01T

LxW [mm]	0.5x0.5(05)<0202>			
Rated Volt. [Vdc]	100(2A)	25(1E)	10(1A)	6.3(0J)
Capacitance	Tolerance	Part Number		
100pF(101)	±20%(M)	GMA05XR72A101MA01T		
150pF(151)	±20%(M)	GMA05XR72A151MA01T		
220pF(221)	±20%(M)	GMA05XR72A221MA01T		
330pF(331)	±20%(M)	GMA05XR72A331MA01T		
470pF(471)	±20%(M)	GMA05XR72A471MA01T		
680pF(681)	±20%(M)	GMA05XR72A681MA01T		
1000pF(102)	±20%(M)	GMA05XR72A102MA01T		
1500pF(152)	±20%(M)		GMA05XR71E152MA11T	
2200pF(222)	±20%(M)		GMA05XR71E222MA11T	
3300pF(332)	±20%(M)		GMA05XR71E332MA11T	
4700pF(472)	±20%(M)		GMA05XR71E472MA11T	
6800pF(682)	±20%(M)			GMA05XR71A682MA01T
10000pF(103)	±20%(M)			GMA05XR71A103MA01T
15000pF(153)	±20%(M)			GMA05XR71A153MA01T
22000pF(223)	±20%(M)			GMA05XR71A223MA01T
33000pF(333)	±20%(M)			
47000pF(473)	±20%(M)			
68000pF(683)	±20%(M)			
0.10μF(104)	±20%(M)			GMA05XR60J104ME12T*

LxW [mm]	0.8x0.8(08)<0303>			
Rated Volt. [Vdc]	100(2A)	25(1E)	10(1A)	6.3(0J)
Capacitance	Tolerance	Part Number		
1500pF(152)	±20%(M)	GMA085R72A152MA01T		
2200pF(222)	±20%(M)	GMA085R72A222MA01T		
3300pF(332)	±20%(M)	GMA085R72A332MA01T		
4700pF(472)	±20%(M)	GMA085R72A472MA01T		
6800pF(682)	±20%(M)	GMA085R72A682MA01T		
10000pF(103)	±20%(M)		GMA085R71E103MA11T	
15000pF(153)	±20%(M)		GMA085R71E153MA11T	
22000pF(223)	±20%(M)		GMA085R71E223MA11T	
33000pF(333)	±20%(M)			GMA085R71A333MA01T
47000pF(473)	±20%(M)			GMA085R71A473MA01T
68000pF(683)	±20%(M)			GMA085R71A683MA01T
0.10μF(104)	±20%(M)			GMA085R71A104MA01T
0.47μF(474)	±20%(M)			GMA085R60J474ME12T*

The part number code is shown in () and Unit is shown in []. < >: EIA [inch] Code

*: Please refer to GMA series Specifications and Test Method(2).

(Part Number) **GM** **A** **0D** **3** **R7** **1A** **103** **M** **A01** **T**
 ① ② ③ ④ ⑤ ⑥ ⑦ ⑧ ⑨ ⑩

① Product ID ② Series
 ⑤ Temperature Characteristics ⑥ Rated Voltage
 ③ Dimension (LxW) ⑦ Capacitance
 ⑧ Capacitance Tolerance ⑨ Individual Specification Code
 ④ Dimension (T) ⑩ Packaging

Packaging Code in Part Number is a code shows STD Tray.

GMA Series Specifications and Test Methods(1)

In case Non "*" is added in PNs table, please refer to GMA Series Specifications and Test Methods (1).
 In case "*" is added in PNs table, please refer to GMA Series Specifications and Test Methods (2).

No.	Item	Specifications	Test Method															
1	Operating Temperature Range	R7: -55 to +125°C	Reference Temperature: 25°C															
2	Rated Voltage	See the previous pages.	The rated voltage is defined as the maximum voltage which may be applied continuously to the capacitor. When AC voltage is superimposed on DC voltage, V^{P-P} or V^{O-P} , whichever is larger, should be maintained within the rated voltage range.															
3	Appearance	No defects or abnormalities	Visual inspection															
4	Dimensions	Within the specified dimensions	Using calipers															
5	Dielectric Strength	No defects or abnormalities	No failure should be observed when a voltage of 250% of the rated voltage is applied between the both terminations for 1 to 5 seconds, provided the charge/discharge current is less than 50mA.															
6	Insulation Resistance	More than 10,000MΩ or 500ΩF (Whichever is smaller)	The insulation resistance should be measured with a DC voltage not exceeding the rated voltage at normal temperature and humidity and within 2 minutes of charging.															
7	Capacitance	Within the specified tolerance	The capacitance/D.F. should be measured at reference temperature at the frequency and voltage shown in the table.															
8	Dissipation Factor (D.F.)	R7: W.V.: 25V min.; 0.025 max. W.V.: 16V/10V; 0.035 max.	<table border="1" style="margin-left: auto; margin-right: auto;"> <tr> <td>Frequency</td> <td>1±0.1kHz</td> </tr> <tr> <td>Voltage</td> <td>1±0.2Vrms</td> </tr> </table>	Frequency	1±0.1kHz	Voltage	1±0.2Vrms											
Frequency	1±0.1kHz																	
Voltage	1±0.2Vrms																	
9	Capacitance Temperature Characteristics	No bias R7: Within +/-15% (-55 to +125°C)	The capacitance change should be measured after 5min. at each specified temp. stage. •The ranges of capacitance change compared with the Reference Temperature value over the temperature ranges shown in the table should be within the specified ranges.* <table border="1" style="margin-left: auto; margin-right: auto;"> <thead> <tr> <th>Step</th> <th>Temperature (°C)</th> </tr> </thead> <tbody> <tr> <td>1</td> <td>25±2</td> </tr> <tr> <td>2</td> <td>-55±3</td> </tr> <tr> <td>3</td> <td>25±2</td> </tr> <tr> <td>4</td> <td>125±3</td> </tr> </tbody> </table> *Initial measurement for high dielectric constant type Perform a heat treatment at 150 +0/-10°C for one hour and then let sit for 24±2 hours at room temperature. Perform the initial measurement.	Step	Temperature (°C)	1	25±2	2	-55±3	3	25±2	4	125±3					
Step	Temperature (°C)																	
1	25±2																	
2	-55±3																	
3	25±2																	
4	125±3																	
10	Mechanical Strength	Bond Strength	Pull force: 0.03N min. MIL-STD-883 Method 2011 Condition D Mount the capacitor on a gold metallized alumina substrate with Au-Sn (80/20) and bond a 25μm (0.001 inch) gold wire to the capacitor terminal using an ultrasonic ball bond. Then, pull wire.															
		Die Shear Strength	Die Shear force: 2N min. MIL-STD-883 Method 2019 Mount the capacitor on a gold metallized alumina substrate with Au-Sn (80/20). Apply the force parallel to the substrate.															
11	Vibration Resistance	Appearance	No defects or abnormalities															
		Capacitance	Within the specified tolerance															
		D.F.	R7: W.V.: 25V min.; 0.025 max. W.V.: 16V/10V; 0.035 max. Ramp frequency from 10 to 55Hz then return to 10Hz all within 1 minute. Amplitude: 1.5 mm (0.06 inch) max. total excursion. Apply this motion for a period of 2 hours in each of 3 mutually perpendicular directions (total 6 hours).															
12	Temperature Cycle	Appearance	No defects or abnormalities															
		Capacitance Change	R7: Within ±7.5% The capacitor should be set for 24±2 hours at room temperature after one hour heat of treatment at 150+0/-10°C, then measure for the initial measurement. Fix the capacitor to the supporting jig in the same manner and under the same conditions as (11) and conduct the five cycles according to the temperatures and time shown in the following table. Set it for 24±2 hours at room temperature, then measure.															
		D.F.	R7: W.V.: 25V min.; 0.025 max. W.V.: 16V/10V; 0.035 max.															
		I.R.	More than 10,000MΩ or 500ΩF (Whichever is smaller)															
		Dielectric Strength	No defects															
			<table border="1" style="margin-left: auto; margin-right: auto;"> <thead> <tr> <th>Step</th> <th>1</th> <th>2</th> <th>3</th> <th>4</th> </tr> </thead> <tbody> <tr> <td>Temp. (°C)</td> <td>Min. Operating Temp. +0/-3</td> <td>Room Temp.</td> <td>Max. Operating Temp. +3/-0</td> <td>Room Temp.</td> </tr> <tr> <td>Time (min.)</td> <td>30±3</td> <td>2 to 3</td> <td>30±3</td> <td>2 to 3</td> </tr> </tbody> </table>	Step	1	2	3	4	Temp. (°C)	Min. Operating Temp. +0/-3	Room Temp.	Max. Operating Temp. +3/-0	Room Temp.	Time (min.)	30±3	2 to 3	30±3	2 to 3
Step	1	2	3	4														
Temp. (°C)	Min. Operating Temp. +0/-3	Room Temp.	Max. Operating Temp. +3/-0	Room Temp.														
Time (min.)	30±3	2 to 3	30±3	2 to 3														

Mounting for testing: The capacitors should be mounted on the substrate as shown below using die bonding and wire bonding when tests No.11 to 15 are performed.

Continued on the following page.

7

GMA Series Specifications and Test Methods(1)

Continued from the preceding page.

In case Non "*" is added in PNs table, please refer to GMA Series Specifications and Test Methods (1).
 In case "*" is added in PNs table, please refer to GMA Series Specifications and Test Methods (2).

No.	Item	Specifications	Test Method
13	Humidity (Steady State)	Appearance	No defects or abnormalities
		Capacitance Change	R7: Within $\pm 12.5\%$
		D.F.	R7: W.V.: 10V min.; 0.05 max.
		I.R.	More than 1,000M Ω or 50 Ω F (Whichever is smaller)
14	Humidity Load	Appearance	No defects or abnormalities
		Capacitance Change	R7: Within $\pm 12.5\%$
		D.F.	R7: W.V.: 10V min.; 0.05 max.
		I.R.	More than 500M Ω or 25 Ω F (Whichever is smaller)
15	High Temperature Load	Appearance	No defects or abnormalities
		Capacitance Change	R7: Within $\pm 12.5\%$
		D.F.	R7: W.V.: 10V min.; 0.05 max.
		I.R.	More than 1,000M Ω or 50 Ω F (Whichever is smaller)
			Set the capacitor for 500 ± 12 hours at 40 $\pm 2^\circ$ C, in 90 to 95% humidity. Take it out and set it for 24 ± 2 hours at room temperature, then measure.
			Apply the rated voltage for 500 ± 12 hours at 40 $\pm 2^\circ$ C, in 90 to 95% humidity and set it for 24 ± 2 hours at room temperature, then measure. The charge/discharge current is less than 50mA.
			A voltage treatment should be given to the capacitor, in which a DC voltage of 200% the rated voltage is applied for one hour at the maximum operating temperature $\pm 3^\circ$ C then it should be set for 24 ± 2 hours at room temperature and the initial measurement should be conducted. Then apply the above mentioned voltage continuously for 1000 ± 12 hours at the same temperature, remove it from the bath, and set it for 24 ± 2 hours at room temperature, then measure. The charge/discharge current is less than 50mA.

Mounting for testing: The capacitors should be mounted on the substrate as shown below using die bonding and wire bonding when tests No.11 to 15 are performed.

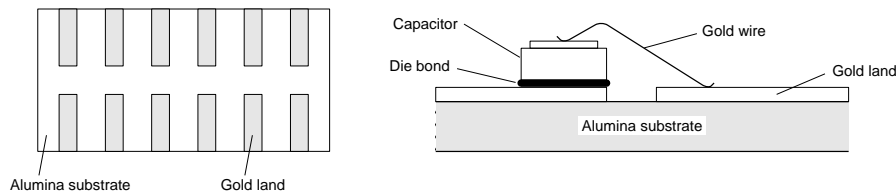

GMA Series Specifications and Test Methods(2)

In case Non "*" is added in PNs table, please refer to GMA Series Specifications and Test Methods (1).
 In case "*" is added in PNs table, please refer to GMA Series Specifications and Test Methods (2).

No.	Item	Specifications	Test Method															
1	Operating Temperature Range	R6 : -55°C to 85°C	Reference Temperature : 25°C															
2	Rated Voltage	See the previous pages.	The rated voltage is defined as the maximum voltage which may be applied continuously to the capacitor. When AC voltage is superimposed on DC voltage, V ^{P-P} or V ^{O-P} , whichever is larger, should be maintained within the rated voltage range.															
3	Appearance	No defects or abnormalities.	Visual inspection.															
4	Dimensions	Within the specified dimensions.	Using calipers.															
5	Dielectric Strength	No defects or abnormalities.	No failure should be observed when 250% of the rated voltage is applied between the terminations for 1 to 5 seconds, provided the charge/discharge current is less than 50mA.															
6	Insulation Resistance	More than 50Ω · F	The insulation resistance should be measured with a DC voltage not exceeding the rated voltage at normal temperature and humidity and within 1 minutes of charging.															
7	Capacitance	Within the specified tolerance.	The capacitance/D.F. should be measured at reference temperature at the frequency and voltage shown in the table.															
8	Dissipation Factor (D.F.)	R6 : 0.1 max.	<table border="1" style="margin-left: auto; margin-right: auto;"> <thead> <tr> <th>Capacitance</th> <th>Frequency</th> <th>Voltage</th> </tr> </thead> <tbody> <tr> <td>C ≤ 10μF (6.3Vmax.)</td> <td>1 ± 0.1kHz</td> <td>0.5 ± 0.1Vrms</td> </tr> </tbody> </table>	Capacitance	Frequency	Voltage	C ≤ 10μF (6.3Vmax.)	1 ± 0.1kHz	0.5 ± 0.1Vrms									
Capacitance	Frequency	Voltage																
C ≤ 10μF (6.3Vmax.)	1 ± 0.1kHz	0.5 ± 0.1Vrms																
9	Capacitance Temperature Characteristics	No bias R6 : Within ±15% (-55°C to +85°C)	<p>The capacitance change should be measured after 5min. at each specified temp. stage.</p> <p>The ranges of capacitance change compared with the Reference Temperature value over the temperature ranges shown in the table should be within the specified ranges.*</p> <table border="1" style="margin-left: auto; margin-right: auto;"> <thead> <tr> <th>Step</th> <th>Temperature (°C)</th> </tr> </thead> <tbody> <tr> <td>1</td> <td>25 ± 2</td> </tr> <tr> <td>2</td> <td>-55 ± 3</td> </tr> <tr> <td>3</td> <td>25 ± 2</td> </tr> <tr> <td>4</td> <td>85 ± 3</td> </tr> </tbody> </table> <p>*Initial measurement for high dielectric constant type Perform a heat treatment at 150 +0/-10°C for one hour and then let sit for 24 ± 2 hours at room temperature. Perform the initial measurement.</p>	Step	Temperature (°C)	1	25 ± 2	2	-55 ± 3	3	25 ± 2	4	85 ± 3					
Step	Temperature (°C)																	
1	25 ± 2																	
2	-55 ± 3																	
3	25 ± 2																	
4	85 ± 3																	
10	Mechanical Strength	Bond Strength Pull force : 0.03N min.	MIL-STD-883 Method 2011 Condition D Mount the capacitor on a gold metallized alumina substrate with Au-Sn (80/20) and bond a 25μm (0.001 inch) gold wire to the capacitor terminal using an ultrasonic ball bond. Then, pull wire.															
		Die Shear Strength Die Shear force : 2N min.	MIL-STD-883 Method 2019 Mount the capacitor on a gold metallized alumina substrate with Au-Sn (80/20). Apply the force parallel to the substrate.															
11	Vibration Resistance	Appearance No defects or abnormalities.	Ramp frequency from 10 to 55Hz then return to 10Hz all within 1 minute. Amplitude : 1.5 mm (0.06 inch) max. total excursion. Apply this motion for a period of 2 hours in each of 3 mutually perpendicular directions (total 6 hours).															
		Capacitance Within the specified tolerance.																
		D.F. R6 : 0.1 max.																
12	Temperature Sudden Change	Appearance No defects or abnormalities.	The capacitor should be set for 24 ± 2 hours at room temperature after one hour heat of treatment at 150 +0/-10°C, then measure for the initial measurement. Fix the capacitor to the supporting jig in the same manner and under the same conditions as (11) and conduct the five cycles according to the temperatures and time shown in the following table. Set it for 48 ± 4 hours at room temperature, then measure.															
		Capacitance Change R6 : Within ±7.5%																
		D.F. R6 : 0.1 max.																
		I.R. More than 50Ω · F																
		Dielectric Strength No defects																
<table border="1" style="margin-left: auto; margin-right: auto;"> <thead> <tr> <th>Step</th> <th>1</th> <th>2</th> <th>3</th> <th>4</th> </tr> </thead> <tbody> <tr> <td>Temp. (°C)</td> <td>Min. Operating Temp. +0/-3</td> <td>Room Temp.</td> <td>Max. Operating Temp. +3/-0</td> <td>Room Temp.</td> </tr> <tr> <td>Time (min.)</td> <td>30 ± 3</td> <td>2 to 3</td> <td>30 ± 3</td> <td>2 to 3</td> </tr> </tbody> </table>				Step	1	2	3	4	Temp. (°C)	Min. Operating Temp. +0/-3	Room Temp.	Max. Operating Temp. +3/-0	Room Temp.	Time (min.)	30 ± 3	2 to 3	30 ± 3	2 to 3
Step	1	2	3	4														
Temp. (°C)	Min. Operating Temp. +0/-3	Room Temp.	Max. Operating Temp. +3/-0	Room Temp.														
Time (min.)	30 ± 3	2 to 3	30 ± 3	2 to 3														

Mounting for testing : The capacitors should be mounted on the substrate as shown below using die bonding and wire bonding when tests No.11 to 14 are performed.

Continued on the following page. ↗

7

GMA Series Specifications and Test Methods(2)

Continued from the preceding page.

In case Non "*" is added in PNs table, please refer to GMA Series Specifications and Test Methods (1).
 In case "*" is added in PNs table, please refer to GMA Series Specifications and Test Methods (2).

No.	Item	Specifications	Test Method
13	High Temperature High Humidity (Steady)	Appearance	No defects or abnormalities.
		Capacitance Change	R6 : Within $\pm 12.5\%$
		D.F.	R6 : 0.2 max.
		I.R.	More than $12.5\Omega \cdot F$
14	Durability	Appearance	No defects or abnormalities.
		Capacitance Change	R6 : Within $\pm 12.5\%$
		D.F.	R6 : 0.2 max.
		I.R.	More than $25\Omega \cdot F$

7

Mounting for testing : The capacitors should be mounted on the substrate as shown below using die bonding and wire bonding when tests No.11 to 14 are performed.

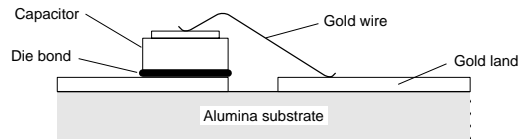
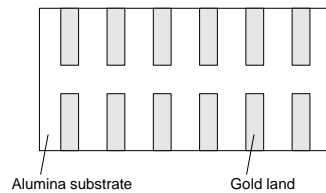

Chip Monolithic Ceramic Capacitors



for Bonding GMD Series

■ Features

1. Small chip size (LxWxT: 0.6x0.3x0.3, 1.0x0.5x0.5mm)
2. Available for Wire/Die bonding due to Gold termination.
3. Suitable for Optical device for telecommunication, IC packaging built-in.

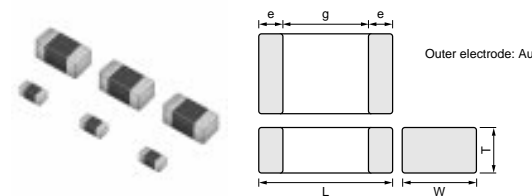

■ Applications

1. Optical device for telecommunication
2. IC, IC packaging built-in

Part Number	Dimensions (mm)				
	L	W	T	e	g min.
GMD033	0.6±0.03	0.3±0.03	0.3±0.03	0.12 to 0.22	0.16
GMD155	1.0±0.05	0.5±0.05	0.5±0.05	0.15 to 0.35	0.3

Capacitance Table

High Dielectric Constant Type X7R(R7)/X5R(R6) Characteristics

3		ex.3: T Dimension [mm]								
LxW [mm]	Rated Voltage [Vdc]	0.6x0.3 (03) <0201>			1.0x0.5 (15) <0402>		0.6x0.3 (03) <0201>	1.0x0.5 (15) <0402>		
		25 (1E)	16 (1C)	10 (1A)	50 (1H)	25 (1E)	16 (1C)	6.3 (0J)	10 (1A)	6.3 (0J)
Capacitance	TC	X7R (R7)					X5R (R6)			
100pF(101)	3									
120pF(121)	3									
150pF(151)	3									
180pF(181)	3									
220pF(221)	3				5					
270pF(271)	3				5					
330pF(331)	3				5					
390pF(391)	3				5					
470pF(471)	3				5					
560pF(561)	3				5					
680pF(681)	3				5					
820pF(821)	3				5					
1000pF(102)	3				5					
1200pF(122)	3				5					
1500pF(152)	3				5					
1800pF(182)		3			5					
2200pF(222)		3			5					
2700pF(272)		3			5					
3300pF(332)		3			5					
3900pF(392)			3		5					
4700pF(472)			3		5					
5600pF(562)			3			5				
6800pF(682)			3			5				
8200pF(822)			3			5				
10000pF(103)				3		5				
12000pF(123)						5				
15000pF(153)						5				
18000pF(183)						5				
22000pF(223)						5				
27000pF(273)						5				
33000pF(333)						5				
39000pF(393)						5				
47000pF(473)						5				
56000pF(563)							5	3		
68000pF(683)							5	3		
82000pF(823)							5	3		
0.10μF(104)							5	3		
0.12μF(124)									5	
0.15μF(154)									5	
0.18μF(184)									5	
0.22μF(224)									5	
0.27μF(274)									5	
0.33μF(334)									5	
0.39μF(394)									5	
0.47μF(474)									5	
1.0μF(105)										5

The part number code is shown in () and Unit is shown in []. < >: EIA [inch] Code

High Dielectric Constant Type X7R(R7) Characteristics

LxW [mm]		0.6x0.3(03)<0201>		
Rated Volt. [Vdc]		25(1E)	16(1C)	10(1A)
Capacitance	Tolerance	Part Number		
100pF(101)	±10%(K)	GMD033R71E101KA01D		
120pF(121)	±10%(K)	GMD033R71E121KA01D		
150pF(151)	±10%(K)	GMD033R71E151KA01D		
180pF(181)	±10%(K)	GMD033R71E181KA01D		
220pF(221)	±10%(K)	GMD033R71E221KA01D		
270pF(271)	±10%(K)	GMD033R71E271KA01D		
330pF(331)	±10%(K)	GMD033R71E331KA01D		
390pF(391)	±10%(K)	GMD033R71E391KA01D		
470pF(471)	±10%(K)	GMD033R71E471KA01D		
560pF(561)	±10%(K)	GMD033R71E561KA01D		
680pF(681)	±10%(K)	GMD033R71E681KA01D		
820pF(821)	±10%(K)	GMD033R71E821KA01D		
1000pF(102)	±10%(K)	GMD033R71E102KA01D		
1200pF(122)	±10%(K)	GMD033R71E122KA01D		
1500pF(152)	±10%(K)	GMD033R71E152KA01D		
1800pF(182)	±10%(K)		GMD033R71C182KA11D	
2200pF(222)	±10%(K)		GMD033R71C222KA11D	
2700pF(272)	±10%(K)		GMD033R71C272KA11D	
3300pF(332)	±10%(K)		GMD033R71C332KA11D	
3900pF(392)	±10%(K)			GMD033R71A392KA01D
4700pF(472)	±10%(K)			GMD033R71A472KA01D
5600pF(562)	±10%(K)			GMD033R71A562KA01D
6800pF(682)	±10%(K)			GMD033R71A682KA01D
8200pF(822)	±10%(K)			GMD033R71A822KA01D
10000pF(103)	±10%(K)			GMD033R71A103KA01D

The part number code is shown in () and Unit is shown in []. <->: EIA [inch] Code

High Dielectric Constant Type X7R(R7) Characteristics

LxW [mm]		1.0x0.5(15)<0402>		
Rated Volt. [Vdc]		50(1H)	25(1E)	16(1C)
Capacitance	Tolerance	Part Number		
220pF(221)	±10%(K)	GMD155R71H221KA01D		
270pF(271)	±10%(K)	GMD155R71H271KA01D		
330pF(331)	±10%(K)	GMD155R71H331KA01D		
390pF(391)	±10%(K)	GMD155R71H391KA01D		
470pF(471)	±10%(K)	GMD155R71H471KA01D		
560pF(561)	±10%(K)	GMD155R71H561KA01D		
680pF(681)	±10%(K)	GMD155R71H681KA01D		
820pF(821)	±10%(K)	GMD155R71H821KA01D		
1000pF(102)	±10%(K)	GMD155R71H102KA01D		
1200pF(122)	±10%(K)	GMD155R71H122KA01D		
1500pF(152)	±10%(K)	GMD155R71H152KA01D		
1800pF(182)	±10%(K)	GMD155R71H182KA01D		
2200pF(222)	±10%(K)	GMD155R71H222KA01D		
2700pF(272)	±10%(K)	GMD155R71H272KA01D		
3300pF(332)	±10%(K)	GMD155R71H332KA01D		
3900pF(392)	±10%(K)	GMD155R71H392KA01D		
4700pF(472)	±10%(K)	GMD155R71H472KA01D		
5600pF(562)	±10%(K)		GMD155R71E562KA01D	
6800pF(682)	±10%(K)		GMD155R71E682KA01D	
8200pF(822)	±10%(K)		GMD155R71E822KA01D	
10000pF(103)	±10%(K)		GMD155R71E103KA01D	
12000pF(123)	±10%(K)		GMD155R71E123KA01D	
15000pF(153)	±10%(K)		GMD155R71E153KA01D	
18000pF(183)	±10%(K)		GMD155R71E183KA01D	
22000pF(223)	±10%(K)		GMD155R71E223KA01D	
27000pF(273)	±10%(K)		GMD155R71E273KA11D	
33000pF(333)	±10%(K)		GMD155R71E333KA11D	
39000pF(393)	±10%(K)		GMD155R71E393KA11D	
47000pF(473)	±10%(K)		GMD155R71E473KA11D	
56000pF(563)	±10%(K)			GMD155R71C563KA11D
68000pF(683)	±10%(K)			GMD155R71C683KA11D
82000pF(823)	±10%(K)			GMD155R71C823KA11D
0.10μF(104)	±10%(K)			GMD155R71C104KA11D

The part number code is shown in () and Unit is shown in []. < >: EIA [inch] Code

8

(Part Number) **GM** **D** **15** **5** **R7** **1H** **221** **K** **A01** **D**
 ① ② ③ ④ ⑤ ⑥ ⑦ ⑧ ⑨ ⑩

① Product ID ② Series
 ⑤ Temperature Characteristics
 ⑥ Capacitance Tolerance

③ Dimension (LxW)
 ⑥ Rated Voltage
 ⑨ Individual Specification Code

④ Dimension (T)
 ⑦ Capacitance
 ⑩ Packaging

Packaging Code in Part Number is a code shows STD 180mm Reel Taping.

High Dielectric Constant Type X5R(R6) Characteristics

LxW [mm]		0.6x0.3(03)<0201>	1.0x0.5(15)<0402>	
Rated Volt. [Vdc]		6.3(0J)	10(1A)	6.3(0J)
Capacitance	Tolerance	Part Number		
56000pF(563)	±10%(K)	GMD033R60J563KE11D*		
68000pF(683)	±10%(K)	GMD033R60J683KE11D*		
82000pF(823)	±10%(K)	GMD033R60J823KE11D*		
0.10μF(104)	±10%(K)	GMD033R60J104KE11D*		
0.12μF(124)	±10%(K)		GMD155R61A124KE12D*	
0.15μF(154)	±10%(K)		GMD155R61A154KE12D*	
0.18μF(184)	±10%(K)		GMD155R61A184KE12D*	
0.22μF(224)	±10%(K)		GMD155R61A224KE12D*	
0.27μF(274)	±10%(K)		GMD155R61A274KE11D*	
0.33μF(334)	±10%(K)		GMD155R61A334KE11D*	
0.39μF(394)	±10%(K)		GMD155R61A394KE11D*	
0.47μF(474)	±10%(K)		GMD155R61A474KE11D*	
1.0μF(105)	±10%(K)			GMD155R60J105KE11D*

The part number code is shown in () and Unit is shown in []. <->: EIA [inch] Code

*: Please refer to GMD series Specifications and Test Method(2).

GMD Series Specifications and Test Methods (1)

In case Non "" is added in PN's table, please refer to GMD Series Specifications and Test Methods (1).
 In case "" is added in PN's table, please refer to GMD Series Specifications and Test Methods (2).

No.	Item	Specifications	Test Method										
1	Operating Temperature Range	R7 : -55°C to 125°C	Reference Temperature : 25°C										
2	Rated Voltage	See the previous pages.	The rated voltage is defined as the maximum voltage which may be applied continuously to the capacitor. When AC voltage is superimposed on DC voltage, V ^{P-P} or V ^{O-P} , whichever is larger, should be maintained within the rated voltage range.										
3	Appearance	No defects or abnormalities.	Visual inspection.										
4	Dimensions	Within the specified dimensions.	Using calipers.										
5	Dielectric Strength	No defects or abnormality.	No failure should be observed when 250% of the rated voltage is applied between the terminations for 1 to 5 seconds, provided the charge/discharge current is less than 50mA.										
6	Insulation Resistance	More than 10,000MΩ or 500Ω · F (Whichever is smaller)	The insulation resistance should be measured with a DC voltage not exceeding the rated voltage at normal temperature and humidity and within 2 minutes of charging.										
7	Capacitance	Within the specified tolerance.	The capacitance/D.F. should be measured at reference temperature at the frequency and voltage shown in the table.										
8	Dissipation Factor (D.F.)	R7 : W.V. 25Vmin. : 0.025 max. W.V. 16/10V : 0.035 max.	<table border="1"> <tr> <td>Frequency</td> <td>1±0.1kHz</td> </tr> <tr> <td>Voltage</td> <td>1±0.2Vrms</td> </tr> </table>	Frequency	1±0.1kHz	Voltage	1±0.2Vrms						
Frequency	1±0.1kHz												
Voltage	1±0.2Vrms												
9	Capacitance Temperature Characteristics	No bias R7 : Within ±15% (-55°C to +125°C)	<p>The capacitance change should be measured after 5min. at each specified temp. stage.</p> <p>The ranges of capacitance change compared with the Reference Temperature value over the temperature ranges shown in the table should be within the specified ranges.*</p> <table border="1"> <thead> <tr> <th>Step</th> <th>Temperature (°C)</th> </tr> </thead> <tbody> <tr> <td>1</td> <td>25±2</td> </tr> <tr> <td>2</td> <td>-55±3</td> </tr> <tr> <td>3</td> <td>25±2</td> </tr> <tr> <td>4</td> <td>125±3</td> </tr> </tbody> </table> <p>*Initial measurement for high dielectric constant type Perform a heat treatment at 150 +0/-10°C for one hour and then let sit for 24±2 hours at room temperature. Perform the initial measurement.</p>	Step	Temperature (°C)	1	25±2	2	-55±3	3	25±2	4	125±3
Step	Temperature (°C)												
1	25±2												
2	-55±3												
3	25±2												
4	125±3												
10	Mechanical Strength	Bond Strength	MIL-STD-883 Method 2011 Condition D Mount the capacitor on a gold metallized alumina substrate with Au-Sn (80/20) and bond a 25mm (0.001 inch) gold wire to the capacitor terminal using an ultrasonic ball bond. Then, pull wire.										
		Die Shear Strength	MIL-STD-883 Method 2019 Mount the capacitor on a gold metallized alumina substrate with Au-Sn (80/20). Apply the force parallel to the substrate.										
11	Vibration Resistance	Appearance	Ramp frequency from 10 to 55Hz then return to 10Hz all within 1 minute. Amplitude : 1.5 mm (0.06 inch) max. total excursion. Apply this motion for a period of 2 hours in each of 3 mutually perpendicular directions (total 6 hours).										
		Capacitance											
		D.F.											
12	Temperature Cycle	Appearance	The capacitor should be set for 24±2 hours at room temperature after one hour heat of treatment at 150+0/-10°C, then measure for the initial measurement. Fix the capacitor to the supporting jig in the same manner and under the same conditions as (11) and conduct the five cycles according to the temperatures and time shown in the following table. Set it for 24±2 hours at room temperature, then measure.										
		Capacitance Change											
		D.F.											
		I.R.											
		Dielectric Strength											

Mounting for testing : The capacitors should be mounted on the substrate as shown below using die bonding, when tests No.11 to 15 are performed.

Continued on the following page. 

GMD Series Specifications and Test Methods (1)

Continued from the preceding page.

**In case Non "" is added in PNs table, please refer to GMD Series Specifications and Test Methods (1).
 In case "" is added in PNs table, please refer to GMD Series Specifications and Test Methods (2).**

No.	Item	Specifications	Test Method
13	Humidity (Steady State)	Appearance	No defects or abnormalities.
		Capacitance Change	R7 : Within $\pm 12.5\%$
		D.F.	R7 : W.V. 25Vmin. : 0.05 max. W.V. 16/10V : 0.05 max.
		I.R.	More than 1,000M Ω or 50 $\Omega \cdot F$ (Whichever is smaller)
			Set the capacitor for 500 ± 12 hours at 40 $\pm 2^\circ C$, in 90 to 95% humidity. Take it out and set it for 24 ± 2 hours at room temperature, then measure.
14	Humidity Load	Appearance	No defects or abnormalities.
		Capacitance Change	R7 : Within $\pm 12.5\%$
		D.F.	R7 : W.V. 25Vmin. : 0.05 max. W.V. 16/10V : 0.05 max.
		I.R.	More than 500M Ω or 25 $\Omega \cdot F$ (Whichever is smaller)
			Apply the rated voltage for 500 ± 12 hours at 40 $\pm 2^\circ C$, in 90 to 95% humidity and set it for 24 ± 2 hours at room temperature, then measure. The charge/discharge current is less than 50mA.
15	High Temperature Load	Appearance	No defects or abnormalities.
		Capacitance Change	R7 : Within $\pm 12.5\%$
		D.F.	R7 : W.V. 25Vmin. : 0.05 max. W.V. 16/10V : 0.05 max.
		I.R.	More than 1,000M Ω or 50 $\Omega \cdot F$ (Whichever is smaller)
			A voltage treatment should be given to the capacitor, in which a DC voltage of 200% the rated voltage is applied for one hour at the maximum operating temperature $\pm 3^\circ C$ then it should be set for 24 ± 2 hours at room temperature and the initial measurement should be conducted. Then apply the above mentioned voltage continuously for 1000 ± 12 hours at the same temperature, remove it from the bath, and set it for 24 ± 2 hours at room temperature, then measure. The charge/discharge current is less than 50mA.

Mounting for testing : The capacitors should be mounted on the substrate as shown below using die bonding. when tests No.11 to 15 are performed.

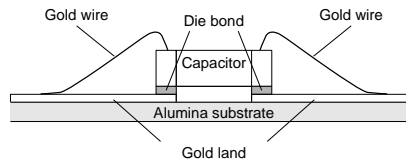
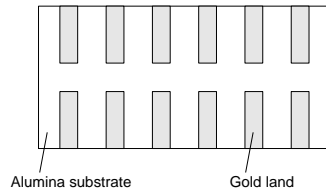

GMD Series Specifications and Test Methods (2)

In case Non "" is added in PNs table, please refer to GMD Series Specifications and Test Methods (1).
 In case "" is added in PNs table, please refer to GMD Series Specifications and Test Methods (2).

No.	Item	Specifications	Test Method															
1	Operating Temperature Range	R6 : -55°C to 85°C	Reference Temperature : 25°C															
2	Rated Voltage	See the previous pages.	The rated voltage is defined as the maximum voltage which may be applied continuously to the capacitor. When AC voltage is superimposed on DC voltage, V ^{P-P} or V ^{O-P} , whichever is larger, should be maintained within the rated voltage range.															
3	Appearance	No defects or abnormalities.	Visual inspection.															
4	Dimensions	Within the specified dimensions.	Using calipers.															
5	Dielectric Strength	No defects or abnormalities.	No failure should be observed when 250% of the rated voltage is applied between the terminations for 1 to 5 seconds, provided the charge/discharge current is less than 50mA.															
6	Insulation Resistance	More than 50Ω · F	The insulation resistance should be measured with a DC voltage not exceeding the rated voltage at normal temperature and humidity and within 1 minutes of charging.															
7	Capacitance	Within the specified tolerance.	The capacitance/D.F. should be measured at reference temperature at the frequency and voltage shown in the table.															
8	Dissipation Factor (D.F.)	R6 : 0.1 max.	<table border="1"> <thead> <tr> <th>Capacitance</th> <th>Frequency</th> <th>Voltage</th> </tr> </thead> <tbody> <tr> <td>C ≤ 10μF (10Vmin.)*1</td> <td>1±0.1kHz</td> <td>1.0±0.2Vrms</td> </tr> <tr> <td>C ≤ 10μF (6.3Vmax.)</td> <td>1±0.1kHz</td> <td>0.5±0.1Vrms</td> </tr> </tbody> </table>	Capacitance	Frequency	Voltage	C ≤ 10μF (10Vmin.)*1	1±0.1kHz	1.0±0.2Vrms	C ≤ 10μF (6.3Vmax.)	1±0.1kHz	0.5±0.1Vrms						
			Capacitance	Frequency	Voltage													
C ≤ 10μF (10Vmin.)*1	1±0.1kHz	1.0±0.2Vrms																
C ≤ 10μF (6.3Vmax.)	1±0.1kHz	0.5±0.1Vrms																
			*1 GMD155 R6 1A 124 to 224 are applied to 0.5±0.1 Vrms.															
9	Capacitance Temperature Characteristics	No bias	R6 : Within ±15% (-55°C to +85°C)															
				<p>The capacitance change should be measured after 5min. at each specified temp. stage.</p> <p>The ranges of capacitance change compared with the Reference Temperature value over the temperature ranges shown in the table should be within the specified ranges.*</p> <table border="1"> <thead> <tr> <th>Step</th> <th>Temperature (°C)</th> </tr> </thead> <tbody> <tr> <td>1</td> <td>25±2</td> </tr> <tr> <td>2</td> <td>-55±3</td> </tr> <tr> <td>3</td> <td>25±2</td> </tr> <tr> <td>4</td> <td>85±3</td> </tr> </tbody> </table> <p>*Initial measurement for high dielectric constant type Perform a heat treatment at 150 +0/-10°C for one hour and then let sit for 24±2 hours at room temperature. Perform the initial measurement.</p>	Step	Temperature (°C)	1	25±2	2	-55±3	3	25±2	4	85±3				
Step	Temperature (°C)																	
1	25±2																	
2	-55±3																	
3	25±2																	
4	85±3																	
10	Mechanical Strength	Bond Strength	Pull force : 0.03N min.															
		Die Shear Strength	Die Shear force : 2N min.															
11	Vibration Resistance	Appearance	No defects or abnormalities.															
		Capacitance	Within the specified tolerance.															
		D.F.	R6 : 0.1 max.															
12	Temperature Sudden Change	Appearance	No defects or abnormalities.															
		Capacitance Change	R6 : Within ±7.5%															
		D.F.	R6 : 0.1 max.															
		I.R.	More than 50Ω · F															
		Dielectric Strength	No defects															
			<p>The capacitor should be set for 24±2 hours at room temperature after one hour heat of treatment at 150+0/-10°C, then measure for the initial measurement. Fix the capacitor to the supporting jig in the same manner and under the same conditions as (11) and conduct the five cycles according to the temperatures and time shown in the following table. Set it for 24±2 hours at room temperature, then measure.</p> <table border="1"> <thead> <tr> <th>Step</th> <th>1</th> <th>2</th> <th>3</th> <th>4</th> </tr> </thead> <tbody> <tr> <td>Temp. (°C)</td> <td>Min. Operating Temp.+0/-3</td> <td>Room Temp.</td> <td>Max. Operating Temp.+3/-0</td> <td>Room Temp.</td> </tr> <tr> <td>Time (min.)</td> <td>30±3</td> <td>2 to 3</td> <td>30±3</td> <td>2 to 3</td> </tr> </tbody> </table>	Step	1	2	3	4	Temp. (°C)	Min. Operating Temp.+0/-3	Room Temp.	Max. Operating Temp.+3/-0	Room Temp.	Time (min.)	30±3	2 to 3	30±3	2 to 3
Step	1	2	3	4														
Temp. (°C)	Min. Operating Temp.+0/-3	Room Temp.	Max. Operating Temp.+3/-0	Room Temp.														
Time (min.)	30±3	2 to 3	30±3	2 to 3														

Mounting for testing : The capacitors should be mounted on the substrate as shown below using die bonding. when tests No.11 to 14 are performed.

Continued on the following page. ↗

GMD Series Specifications and Test Methods (2)

Continued from the preceding page.

**In case Non "*" is added in PNs table, please refer to GMD Series Specifications and Test Methods (1).
 In case "*" is added in PNs table, please refer to GMD Series Specifications and Test Methods (2).**

No.	Item	Specifications	Test Method
13	High Temperature High Humidity (Steady)	Appearance	No defects or abnormalities.
		Capacitance Change	R6 : Within $\pm 12.5\%$
		D.F.	R6 : 0.2 max.
		I.R.	More than $12.5\Omega \cdot F$
14	Durability	Appearance	No defects or abnormalities.
		Capacitance Change	R6 : Within $\pm 12.5\%$
		D.F.	R6 : 0.2 max.
		I.R.	More than $25\Omega \cdot F$

Apply the rated voltage for 500 ± 12 hours at $40 \pm 2^\circ\text{C}$, in 90 to 95% humidity and set it for 24 ± 2 hours at room temperature, then measure. The charge/discharge current is less than 50mA.

- Initial measurement
Perform a heat treatment at $150+0/-10^\circ\text{C}$ for one hour and then let sit for 24 ± 2 hours at room temperature. Perform the initial measurement.
- Measurement after test
Perform a heat treatment at $150+0/-10^\circ\text{C}$ for one hour and then let sit for 24 ± 2 hours at room temperature, then measure.

Apply 150%*2 of the rated voltage for 1000 ± 12 hours at the maximum operating temperature $\pm 3^\circ\text{C}$. Let sit for 24 ± 2 hours at room temperature, then measure. The charge/ discharge current is less than 50mA.

*2 GMD155 R6 1A 274 to 474 are applied to 120%.

- Initial measurement
Perform a heat treatment at $150+0/-10^\circ\text{C}$ for one hour and then let sit for 24 ± 2 hours at room temperature. Perform the initial measurement.
- Measurement after test
Perform a heat treatment at $150+0/-10^\circ\text{C}$ for one hour and then let sit for 24 ± 2 hours at room temperature, then measure.

Mounting for testing : The capacitors should be mounted on the substrate as shown below using die bonding. when tests No.11 to 14 are performed.

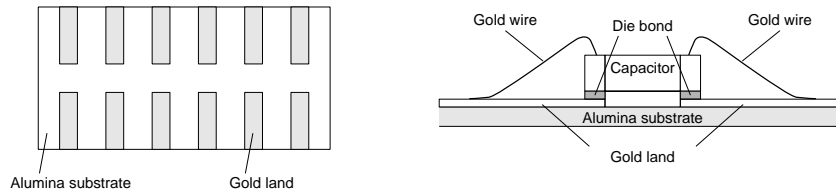

Package

■ Minimum Quantity Guide

Part Number	Dimensions (mm)			Quantity (pcs.)						
				ø180mm Reel		ø330mm Reel		Bulk Case	Bulk Bag	
	L	W	T	Paper Tape	Embossed Tape	Paper Tape	Embossed Tape			
Packaging Code				D	L	J	K	C	Bulk : B Tray : T	
For General Purpose	GRM02	0.4	0.2	0.2	20,000 ¹⁾	40,000 ¹⁾	-	-	-	1,000
	GRM03	0.6	0.3	0.3	15,000	-	50,000	-	-	1,000
	GRM15	1.0	0.5	0.25/0.3	10,000	-	50,000	-	-	1,000
				0.5	10,000	-	50,000	-	50,000	1,000
	GRM18	1.6	0.8	0.5	4,000	-	10,000	-	-	1,000
				0.8	4,000	-	10,000	-	15,000 ²⁾	1,000
	GRM21	2.0	1.25	0.6	4,000	-	10,000	-	10,000	1,000
				0.85	4,000	-	10,000	-	-	1,000
	GRM31	3.2	1.6	1.0/1.25	-	3,000	-	10,000	5,000 ²⁾	1,000
				0.6/0.85	4,000	-	10,000	-	-	1,000
				1.15	-	3,000	-	10,000	-	1,000
	GRM32	3.2	2.5	1.6	-	2,000	-	6,000	-	1,000
				0.85	4,000	-	10,000	-	-	1,000
				1.15	-	3,000	-	10,000	-	1,000
				1.35	-	2,000	-	8,000	-	1,000
	GRM43	4.5	3.2	1.6	-	2,000	-	6,000	-	1,000
				1.8/2.0	-	1,000	-	4,000	-	1,000
				2.5	-	1,000	-	5,000	-	1,000
				1.15	-	1,000	-	4,000	-	1,000
	GRM55	5.7	5.0	1.35/1.6	-	1,000	-	4,000	-	1,000
1.8/2.0				-	1,000	-	4,000	-	1,000	
2.5				-	500	-	2,000	-	500	
3.2				-	300	-	1,500	-	500	
High Power Type	GJM03	0.6	0.3	0.3	15,000	-	50,000	-	1,000	
	GJM15	1.0	0.5	0.5	10,000	-	50,000	-	50,000	
High Frequency	GQM18	1.6	0.8	0.7/0.8	4,000	-	10,000	-	1,000	
	GQM21	2.0	1.25	0.85	4,000	-	10,000	-	1,000	
	ERB18	1.6	0.8	0.9 max.	4,000	-	10,000	-	1,000	
	ERB21	2.0	1.25	1.35 max.	-	3,000	-	10,000	1,000	
	ERB32	3.2	2.5	1.7 max.	-	2,000	-	8,000	1,000	
Microchip	GMA0D	0.38	0.38	0.3	-	-	-	-	400 ³⁾	
	GMA05	0.5	0.5	0.35	-	-	-	-	400 ³⁾	
	GMA08	0.8	0.8	0.5	-	-	-	-	400 ³⁾	
	GMD03	0.6	0.3	0.3	15,000	-	50,000	-	1,000	
	GMD15	1.0	0.5	0.5	10,000	-	50,000	-	1,000	
Array	GNM0M	0.9	0.6	0.45	10,000	-	50,000	-	1,000	
	GNM1M	1.37	1.0	0.5/0.6/0.8	4,000	-	10,000	-	1,000	
	GNM21	2.0	1.25	0.5/0.6/0.85	4,000	-	10,000	-	1,000	
				0.8/0.85	4,000	-	10,000	-	1,000	
Low ESL	LLL15	0.5	1.0	0.3	10,000 ⁴⁾	-	50,000 ⁴⁾	-	1,000	
				0.5	-	4,000	-	10,000	-	1,000
	LLL21	1.25	2.0	0.5/0.6	-	4,000	-	10,000	1,000	
				0.85	-	3,000	-	10,000	1,000	
	LLL31	1.6	3.2	0.5/0.7	-	4,000	-	10,000	1,000	
				1.15	-	3,000	-	10,000	1,000	
	LLA18	1.6	0.8	0.5	-	4,000	-	10,000	1,000	
	LLA21	2.0	1.25	0.5	-	4,000	-	10,000	1,000	
				0.85	-	3,000	-	10,000	1,000	
	LLA31	3.2	1.6	0.5	-	4,000	-	10,000	1,000	
				0.85	-	3,000	-	10,000	1,000	
	LLM21	2.0	1.25	0.5	-	4,000	-	10,000	1,000	
				1.15	-	3,000	-	10,000	1,000	
	LLM31	3.2	1.6	0.5	-	4,000	-	10,000	1,000	

1) 8mm width 2mm pitch Paper Taping. 4mm width 1mm pitch Embossed Taping.

2) There are parts number without bulk case.

3) Tray

4) LLL15: ø180mm Reel Paper Taping Packaging Code: E, ø330mm Reel Paper Taping Packaging Code: F

Continued on the following page. 

Package

Continued from the preceding page.

■ Tape Carrier Packaging

(1) Dimensions of Reel

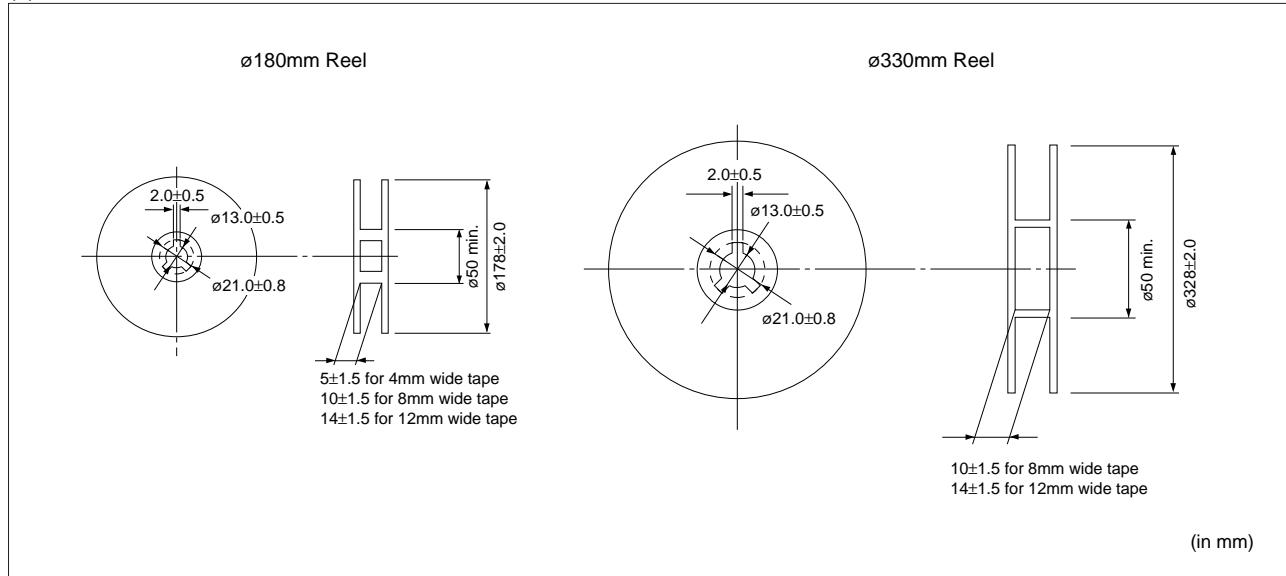

(2) Dimensions of Paper Tape

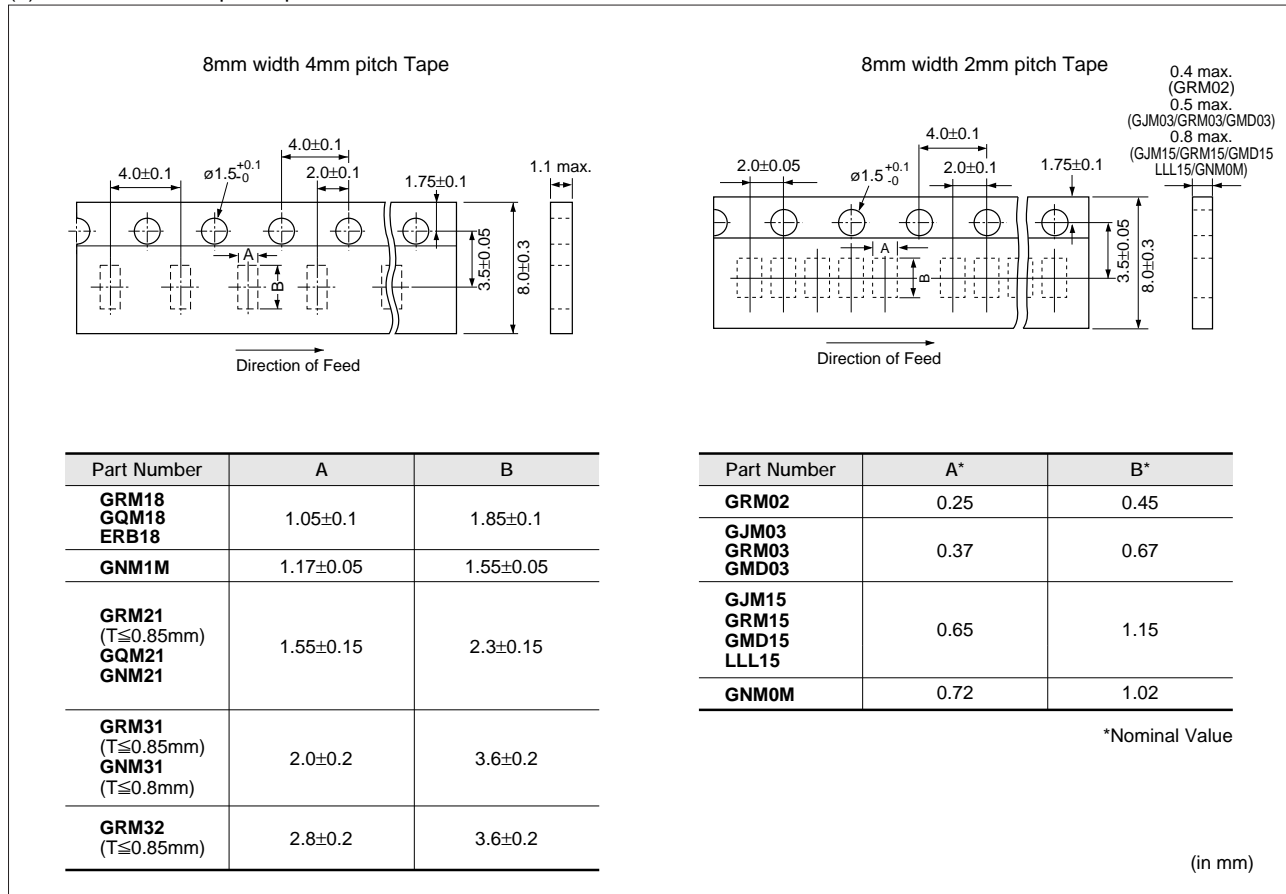

Continued on the following page. ↗

Package

Continued from the preceding page.

(3) Dimensions of Embossed Tape

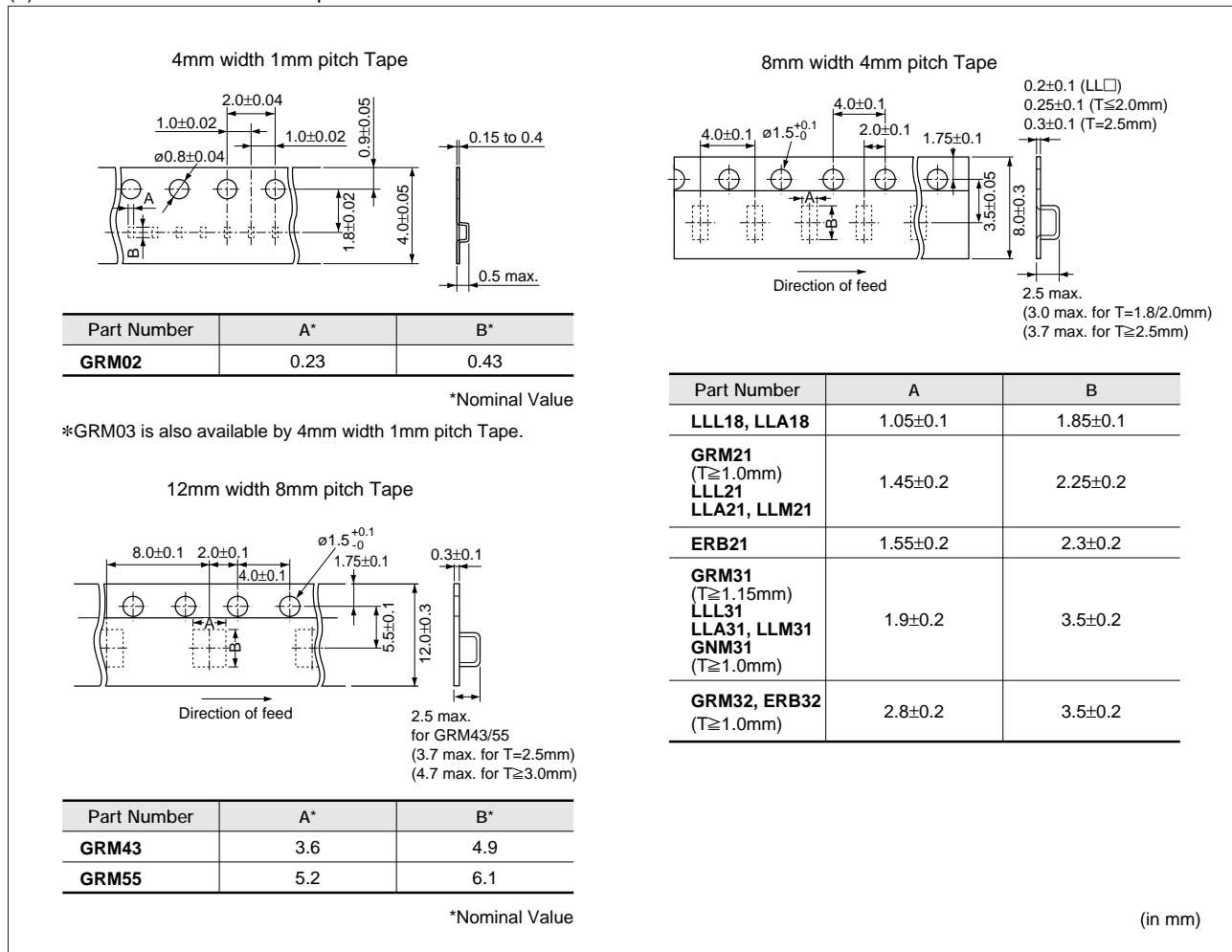

(in mm)

(4) Taping Method

- ① Tapes for capacitors are wound clockwise. The sprocket holes are to the right as the tape is pulled toward the user.
- ② Part of the leader and part of the empty tape should be attached to the end of the tape as follows.
- ③ The top tape and base tape are not attached at the end of the tape for a minimum of 5 pitches.
- ④ Missing capacitors number within 0.1% of the number per reel or 1 pc, whichever is greater, and are not continuous.
- ⑤ The top tape and bottom tape should not protrude beyond the edges of the tape and should not cover sprocket holes.
- ⑥ Cumulative tolerance of sprocket holes, 10 pitches: ±0.3mm.
- ⑦ Peeling off force: 0.1 to 0.6N* in the direction shown below.

*GRM02
 GRM03
 GJM03
 GMD03 } : 0.05 to 0.5N

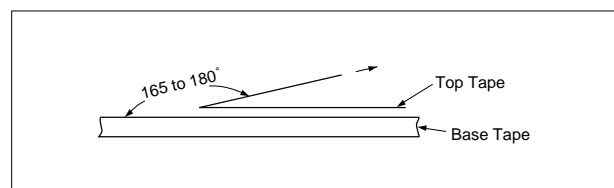
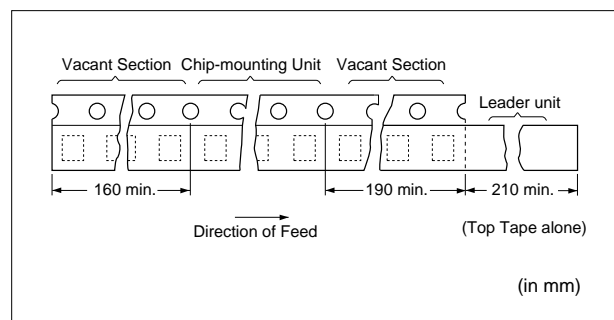

Continued on the following page.

Package

☒ Continued from the preceding page.

■ Dimensions of Bulk Case Packaging

The bulk case uses antistatic materials. Please contact Murata for details.

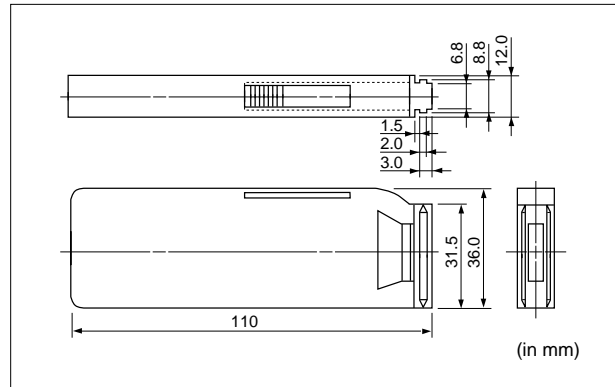

⚠ Caution

■ Storage and Operation condition

1. The performance of chip monolithic ceramic capacitors may be affected by the storage conditions.
 - 1-1. Store capacitors in the following conditions:
Temperature of +5°C to +40°C and a Relative Humidity of 20% to 70%.
 - (1) Sunlight, dust, rapid temperature changes, corrosive gas atmosphere or high temperature and humidity conditions during storage may affect the solderability and the packaging performance. Please use product within six months of receipt.
 - (2) Please confirm solderability before using after six months. Store the capacitors without opening the original bag. Even if the storage period is short, do not exceed the specified atmospheric conditions.
 - 1-2. Corrosive gas can react with the termination (external) electrodes or lead wires of capacitors, and result in poor solderability. Do not store the capacitors in an atmosphere consisting of corrosive gas (e.g., hydrogen sulfide, sulfur dioxide, chlorine, ammonia gas, etc.).
 - 1-3. Due to moisture condensation caused by rapid humidity changes, or the photochemical change caused by direct sunlight on the terminal electrodes and/or the resin/epoxy coatings, the solderability and electrical performance may deteriorate. Do not store capacitors under direct sunlight or in high humidity conditions.



■ Rating

1. Temperature Dependent Characteristics

1. The electrical characteristics of the capacitor can change with temperature.

1-1. For capacitors having larger temperature dependency, the capacitance may change with temperature changes.

The following actions are recommended in order to insure suitable capacitance values.

(1) Select a suitable capacitance for the operating temperature range.

(2) The capacitance may change within the rated temperature.

When you use a high dielectric constant type capacitors in a circuit that needs a tight (narrow) capacitance tolerance. Example: a time constant circuit., please carefully consider the characteristics of these capacitors, such as their aging, voltage, and temperature characteristics. And check capacitors using your actual appliances at the intended environment and operating conditions.

Typical Temperature Characteristics Char. R6(X5R)

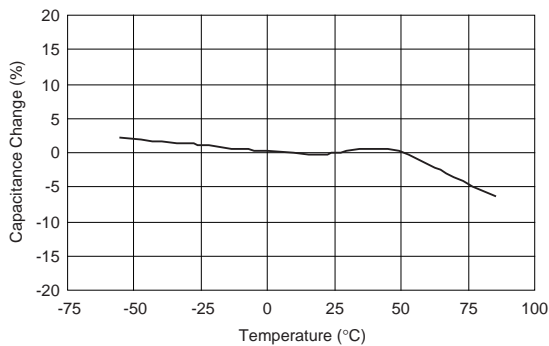

Typical Temperature Characteristics Char. R7(X7R)

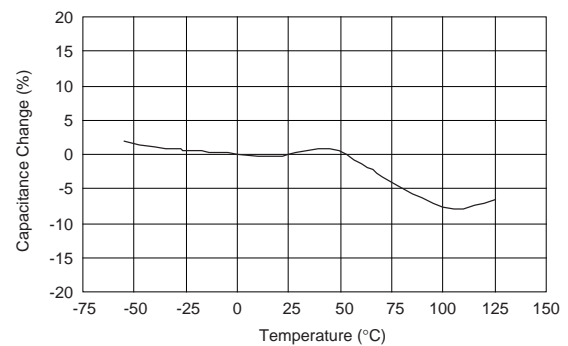

Typical Temperature Characteristics Char. F5(Y5V)

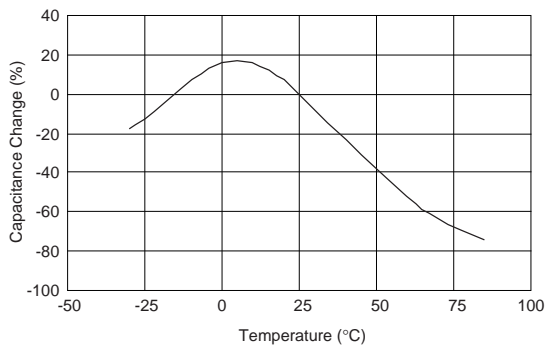

2. Measurement of Capacitance

1. Measure capacitance with the voltage and the frequency specified in the product specifications.

1-1. The output voltage of the measuring equipment may decrease when capacitance is high occasionally. Please confirm whether a prescribed measured voltage is impressed to the capacitor.

1-2. The capacitance values of high dielectric constant type capacitors change depending on the AC voltage applied. Please consider the AC voltage characteristics when selecting a capacitor to be used in a AC circuit.

Continued on the following page.

⚠ Caution

☞ Continued from the preceding page.

3. Applied Voltage

1. Do not apply a voltage to the capacitor that exceeds the rated voltage as called-out in the specifications.
 - 1-1. Applied voltage between the terminals of a capacitor shall be less than or equal to the rated voltage.
 - (1) When AC voltage is superimposed on DC voltage, the zero-to-peak voltage shall not exceed the rated DC voltage.
When AC voltage or pulse voltage is applied, the peak-to-peak voltage shall not exceed the rated DC voltage.
 - (2) Abnormal voltages (surge voltage, static electricity, pulse voltage, etc.) shall not exceed the rated DC voltage.

Typical Voltage Applied to the DC Capacitor

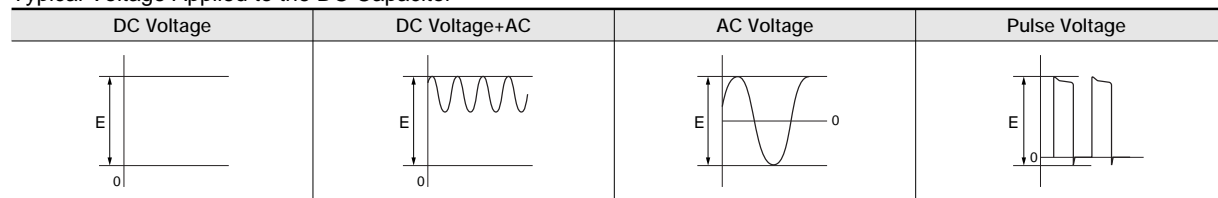

(E: Maximum possible applied voltage.)

1-2. Influence of overvoltage

Overvoltage that is applied to the capacitor may result in an electrical short circuit caused by the breakdown of the internal dielectric layers .
The time duration until breakdown depends on the applied voltage and the ambient temperature.

4. Applied Voltage and Self-heating Temperature

1. When the capacitor is used in a high-frequency voltage, pulse voltage, application, be sure to take into account self-heating may be caused by resistant factors of the capacitor.
 - 1-1. The load should be contained to the level such that when measuring at atomospheric temperature of 25°C, the product's self-heating remains below 20°C and surface temperature of the capacitor in the actual circuit remains wiyhin the maximum operating temperature.

Continued on the following page. ☞



Continued from the preceding page.

5. DC Voltage and AC Voltage Characteristic

1. The capacitance value of a high dielectric constant type capacitor changes depending on the DC voltage applied. Please consider the DC voltage characteristics when a capacitor is selected for use in a DC circuit.

1-1. The capacitance of ceramic capacitors may change sharply depending on the applied voltage. (See figure)

Please confirm the following in order to secure the capacitance.

- (1) Whether the capacitance change caused by the applied voltage is within the range allowed or not.
- (2) In the DC voltage characteristics, the rate of capacitance change becomes larger as voltage increases. Even if the applied voltage is below the rated voltage. When a high dielectric constant type capacitor is in a circuit that needs a tight (narrow) capacitance tolerance. Example: a time constant circuit., please carefully consider the characteristics of these capacitors, such as their aging, voltage, and temperature characteristics. And check capacitors using your actual appliances at the intended environment and operating conditions.

2. The capacitance values of high dielectric constant type capacitors change depending on the AC voltage applied.

Please consider the AC voltage characteristics when selecting a capacitor to be used in a AC circuit.

[DC Voltage Characteristics]

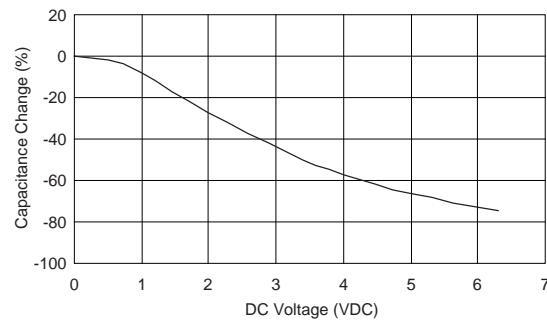

[AC Voltage Characteristics]

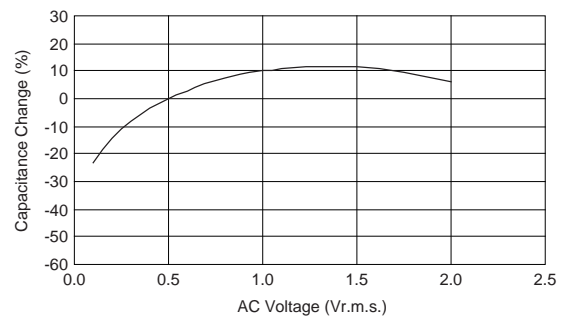

6. Capacitance Aging

1. The high dielectric constant type capacitors have the characteristic in which the capacitance value decreases with passage of time.

When you use a high dielectric constant type capacitors in a circuit that needs a tight (narrow) capacitance tolerance. Example: a time constant circuit., please carefully consider the characteristics of these capacitors, such as their aging, voltage, and temperature characteristics. And check capacitors using your actual appliances at the intended environment and operating conditions.

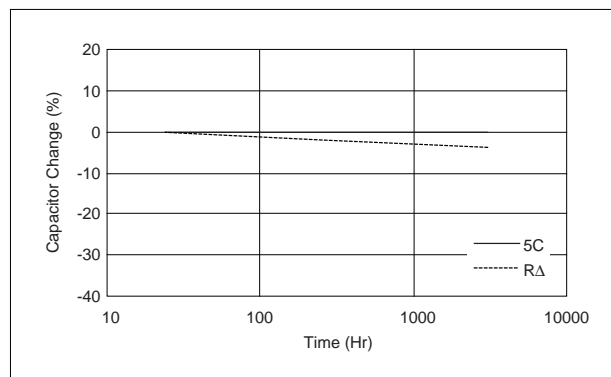

Continued on the following page. ↗

⚠ Caution

☒ Continued from the preceding page.

7. Vibration and Shock

1. The capacitors mechanical stress (vibration and shock) shall be specified for the use environment.
Please confirm the kind of vibration and/or shock, its condition, and any generation of resonance.
Please mount the capacitor so as not to generate resonance, and do not allow any impact on the terminals.
2. Mechanical shock due to falling may cause damage or a crack in the dielectric material of the capacitor.
Do not use a fallen capacitor because the quality and reliability may be deteriorated.
3. When printed circuit boards are piled up or handled, the corners of another printed circuit board should not be allowed to hit the capacitor in order to avoid a crack or other damage to the capacitor.

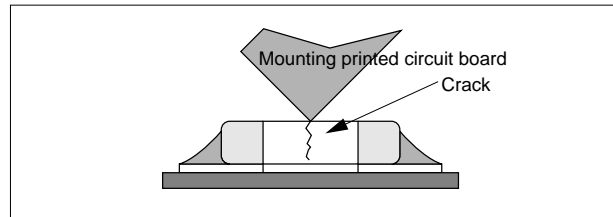
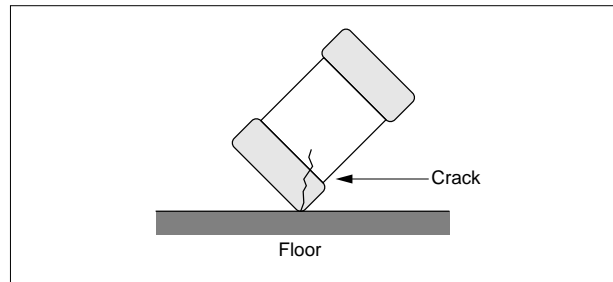

Caution

■ Soldering and Mounting

1. Mounting Position

1. Confirm the best mounting position and direction that minimizes the stress imposed on the capacitor during flexing or bending the printed circuit board.
 - 1-1. Choose a mounting position that minimizes the stress imposed on the chip during flexing or bending of the board.

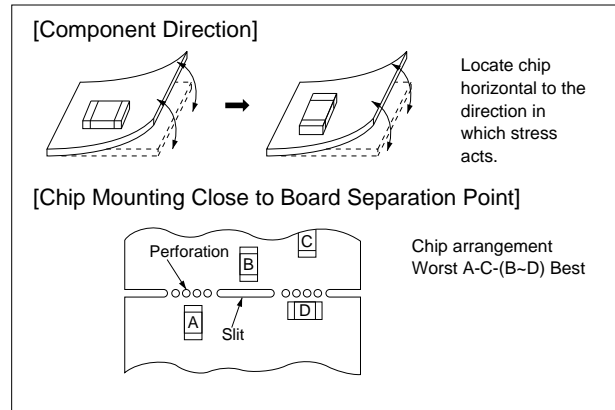

2. Information before Mounting

1. Do not re-use capacitors that were removed from the equipment.
2. Confirm capacitance characteristics under actual applied voltage.
3. Confirm the mechanical stress under actual process and equipment use.
4. Confirm the rated capacitance, rated voltage and other electrical characteristics before assembly.

5. Prior to use, confirm the Solderability for the capacitors that were in long-term storage.
6. Prior to measuring capacitance, carry out a heat treatment for capacitors that were in long-term storage.
7. The use of Sn-Zn based solder will deteriorate the reliability of the MLCC.
 Please contact our sales representative or product engineers on the use of Sn-Zn based solder in advance.

3. Maintenance of the Mounting (pick and place) Machine

1. Make sure that the following excessive forces are not applied to the capacitors.
 - 1-1. In mounting the capacitors on the printed circuit board, any bending force against them shall be kept to a minimum to prevent them from any bending damage or cracking. Please take into account the following precautions and recommendations for use in your process.
 - (1) Adjust the lowest position of the pickup nozzle so as not to bend the printed circuit board.
 - (2) Adjust the nozzle pressure within a static load of 1N to 3N during mounting.
2. Dirt particles and dust accumulated between the suction nozzle and the cylinder inner wall prevent the nozzle from moving smoothly. This imposes greater force upon the chip during mounting, causing cracked chips. Also the locating claw, when worn out, imposes uneven forces on the chip when positioning, causing cracked chips. The suction nozzle and the locating claw must be maintained, checked and replaced periodically.

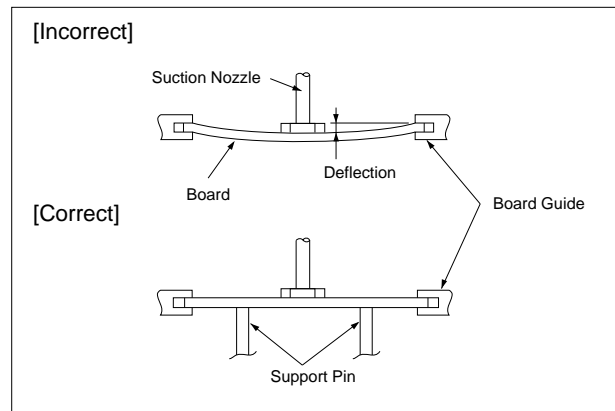

Continued on the following page. ↗

Caution

Continued from the preceding page.

4-1. Reflow Soldering

- When sudden heat is applied to the components, the mechanical strength of the components will decrease because a sudden temperature change causes deformation inside the components. In order to prevent mechanical damage to the components, preheating is required for both the components and the PCB board. Preheating conditions are shown in table 1. It is required to keep the temperature differential between the solder and the components surface (ΔT) as small as possible.
- Solderability of Tin plating termination chips might be deteriorated when a low temperature soldering profile where the peak solder temperature is below the melting point of Tin is used. Please confirm the Solderability of Tin plated termination chips before use.
- When components are immersed in solvent after mounting, be sure to maintain the temperature difference (ΔT) between the component and the solvent within the range shown in the table 1.

Table 1

Part Number	Temperature Differential
GRM02/03/15/18/21/31 GJM03/15 LLL15/18/21/31 ERB18/21 GQM18/21	$\Delta T \leq 190^\circ\text{C}$
GRM32/43/55 LLA18/21/31 LLM21/31 GNM ERB32	$\Delta T \leq 130^\circ\text{C}$

Recommended Conditions

	Pb-Sn Solder		Lead Free Solder
	Infrared Reflow	Vapor Reflow	
Peak Temperature	230 to 250°C	230 to 240°C	240 to 260°C
Atmosphere	Air	Air	Air or N ₂

Pb-Sn Solder: Sn-37Pb
 Lead Free Solder: Sn-3.0Ag-0.5Cu

4. Optimum Solder Amount for Reflow Soldering

- Overly thick application of solder paste results in a excessive solder fillet height. This makes the chip more susceptible to mechanical and thermal stress on the board and may cause the chips to crack.
- Too little solder paste results in a lack of adhesive strength on the outer electrode, which may result in chips breaking loose from the PCB.
- Make sure the solder has been applied smoothly to the end surface to a height of 0.2mm* min.

Inverting the PCB

Make sure not to impose any abnormal mechanical shocks to the PCB.

[Standard Conditions for Reflow Soldering]

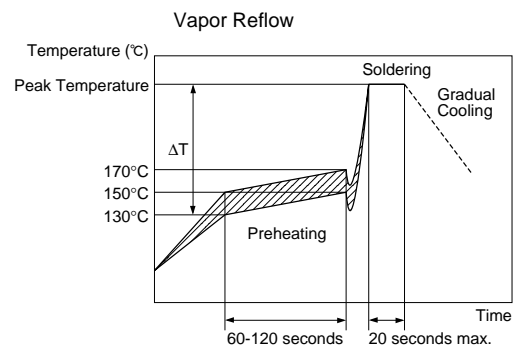
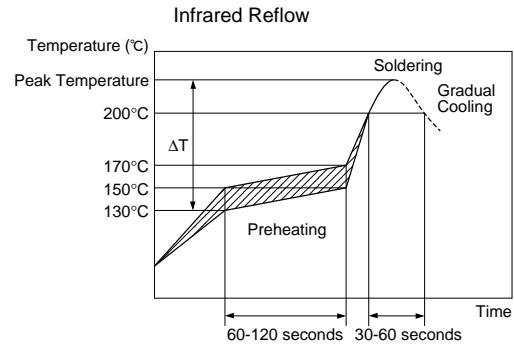

[Allowable Reflow Soldering Temperature and Time]

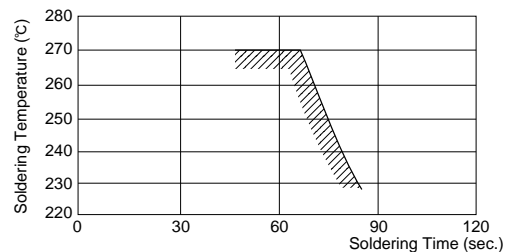

In case of repeated soldering, the accumulated soldering time must be within the range shown above.

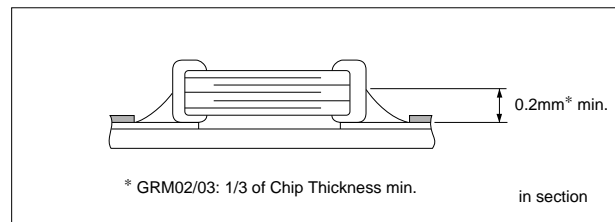

Continued on the following page. ↗



Continued from the preceding page.

4-2. Flow Soldering

- When sudden heat is applied to the components, the mechanical strength of the components will decrease because a sudden temperature change causes deformation inside the components. In order to prevent mechanical damage in the components, preheating should be required for both of the components and the PCB board.
Preheating conditions are shown in table 2. It is required to keep temperature differential between the solder and the components surface (ΔT) as small as possible.
- Excessively long soldering time or high soldering temperature can result in leaching of the outer electrodes, causing poor adhesion or a reduction in capacitance value due to loss of contact between electrodes and end termination.
- When components are immersed in solvent after mounting, be sure to maintain the temperature difference (ΔT) between the component and solvent within the range shown in the table 2.
- Do not apply flow soldering to chips not listed in table 2.

Table 2

Part Number	Temperature Differential
GRM18/21/31	$\Delta T \leq 150^\circ\text{C}$
LLL21/31	
ERB18/21	
GQM18/21	

Recommended Conditions

	Pb-Sn Solder	Lead Free Solder
Preheating Peak Temperature	90 to 110°C	100 to 120°C
Soldering Peak Temperature	240 to 250°C	250 to 260°C
Atmosphere	Air	N ₂

Pb-Sn Solder: Sn-37Pb
 Lead Free Solder: Sn-3.0Ag-0.5Cu

5. Optimum Solder Amount for Flow Soldering

- The top of the solder fillet should be lower than the thickness of components. If the solder amount is excessive, the risk of cracking is higher during board bending or any other stressful condition.

[Standard Conditions for Flow Soldering]

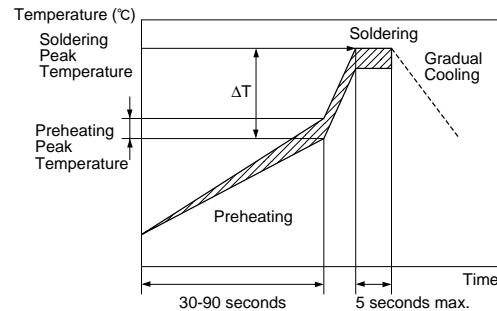

[Allowable Flow Soldering Temperature and Time]

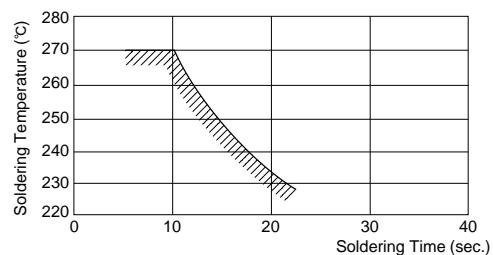

In case of repeated soldering, the accumulated soldering time must be within the range shown above.

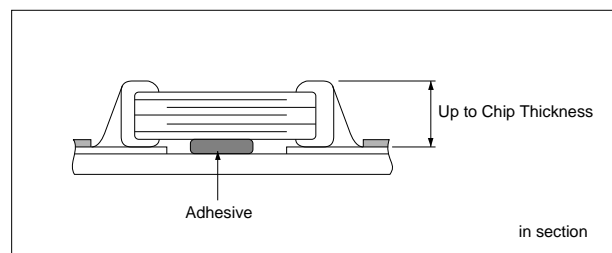

Continued on the following page. ↗

⚠ Caution

☒ Continued from the preceding page.

4-3. Correction with a Soldering Iron

1. When sudden heat is applied to the components when using a soldering iron, the mechanical strength of the components will decrease because the extreme temperature change can cause deformations inside the components. In order to prevent mechanical damage to the components, preheating is required for both the components and the PCB board. Preheating conditions, (The "Temperature of the Soldering Iron Tip", "Preheating Temperature", "Temperature Differential" between the iron tip and the components and the PCB), should be within the conditions of table 3. It is required to keep the temperature differential between the soldering iron and the component surfaces (ΔT) as small as possible.
2. After soldering, do not allow the component/PCB to rapidly cool down.
3. The operating time for the re-working should be as short as possible. When re-working time is too long, it may cause solder leaching, and that will cause a reduction in the adhesive strength of the terminations.
4. Optimum Solder amount when re-working with a Soldering Iron

- 4-1. In case of sizes smaller than 0603, (GRM03/15/18, GJM03/15, QM18, ERB18), the top of the solder fillet should be lower than 2/3's of the thickness of the component or 0.5mm whichever is smaller. In case of 0805 and larger sizes, (GRM21/31/32/43/55, QM21, ERB21/32), the top of the solder fillet should be lower than 2/3's of the thickness of the component. If the solder amount is excessive, the risk of cracking is higher during board bending or under any other stressful condition.
- 4-2. A soldering iron with a tip of $\phi 3\text{mm}$ or smaller should be used. It is also necessary to keep the soldering iron from touching the components during the re-work.
- 4-3. Solder wire with $\phi 0.5\text{mm}$ or smaller is required for soldering.

4-4. Leaded Component Insertion

1. If the PCB is flexed when leaded components (such as transformers and ICs) are being mounted, chips may crack and solder joints may break.
Before mounting leaded components, support the PCB using backup pins or special jigs to prevent warping.

5. Washing

Excessive ultrasonic oscillation during cleaning can cause the PCBs to resonate, resulting in cracked chips or broken solder joints. Take note not to vibrate PCBs.

Table 3

Part Number	Temperature of Soldering Iron Tip	Preheating Temperature	Temperature Differential (ΔT)	Atmosphere
GRM03/15/18/21/31 GJM03/15 QM18/21 ERB18/21	350°C max.	150°C min.	$\Delta T \leq 190^\circ\text{C}$	Air
GRM32/43/55 ERB32	280°C max.	150°C min.	$\Delta T \leq 130^\circ\text{C}$	Air

*Applicable for both Pb-Sn and Lead Free Solder.

Pb-Sn Solder: Sn-37Pb

Lead Free Solder: Sn-3.0Ag-0.5Cu

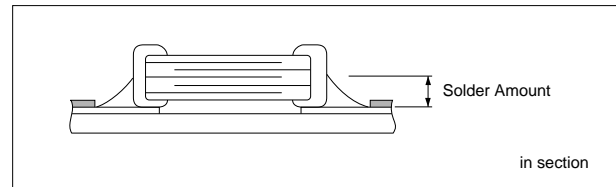

Continued on the following page. ☒

Caution

Continued from the preceding page.

6. Electrical Test on Printed Circuit Board

1. Confirm position of the support pin or specific jig, when inspecting the electrical performance of a capacitor after mounting on the printed circuit board.
 - 1-1. Avoid bending printed circuit board by the pressure of a test pin, etc.

The thrusting force of the test probe can flex the PCB, resulting in cracked chips or open solder joints.

Provide support pins on the back side of the PCB to prevent warping or flexing.
 - 1-2. Avoid vibration of the board by shock when a test pin contacts a printed circuit board.

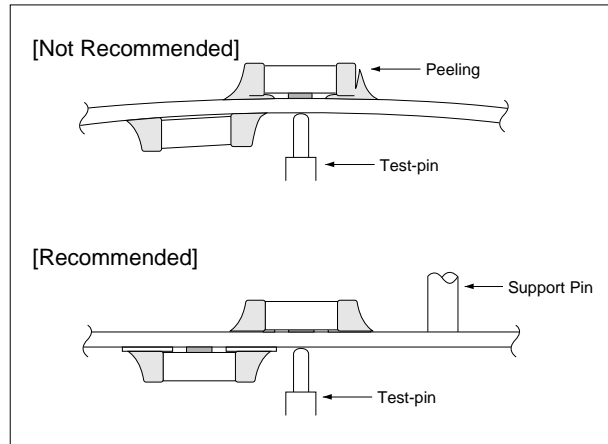

7. Printed Circuit Board Cropping

1. After mounting a capacitor on a printed circuit board, do not apply any stress to the capacitor that is caused by bending or twisting the board.
 - 1-1. In cropping the board, the stress as shown right may cause the capacitor to crack.

Try not to apply this type of stress to a capacitor.

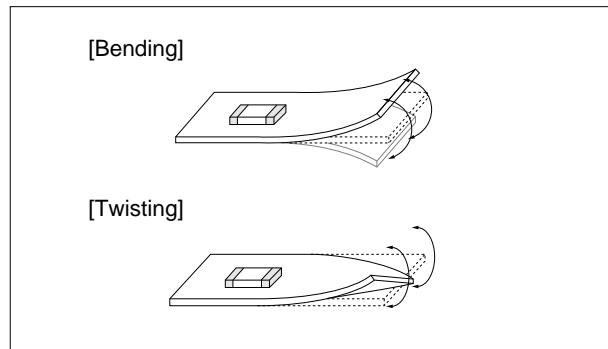

2. Check of the cropping method for the printed circuit board in advance.
 - 2-1. Printed circuit board cropping shall be carried out by using a jig or an apparatus to prevent the mechanical stress which can occur to the board.

(1) Example of a suitable jig

Recommended example: the board should be pushed as close to the near the cropping jig as possible and from the back side of board in order to minimize the compressive stress applied to capacitor.

Not recommended example* when the board is pushed at a point far from the cropping jig and from the front side of board as below, the capacitor may form a crack caused by the tensile stress applied to capacitor.

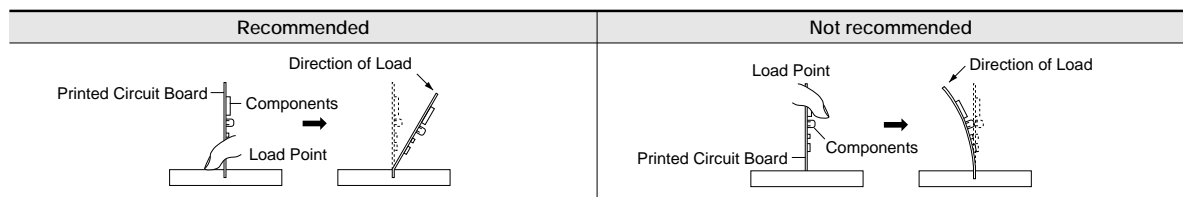
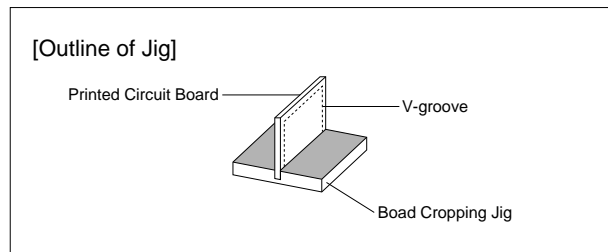

Continued on the following page. ↗

! Caution

Continued from the preceding page.

(2) Example of a suitable machine

An outline of a printed circuit board cropping machine is shown as follows. Along the lines with the V-grooves on printed circuit board, the top and bottom blades are aligned to one another when cropping the board.

The misalignment of the position between top and bottom blades may cause the capacitor to crack.

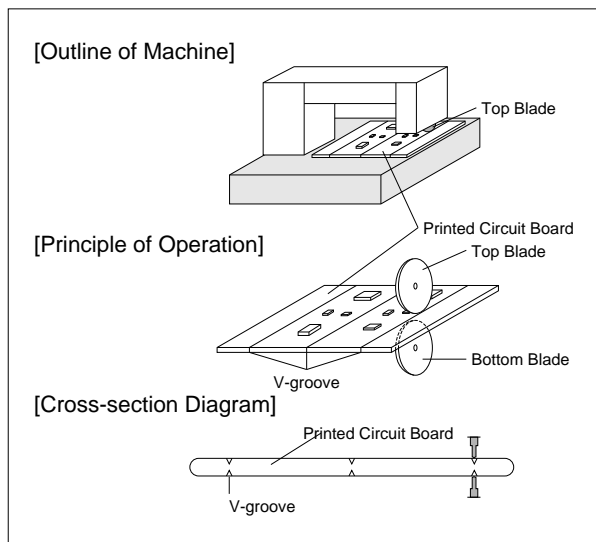

Recommended	Not Recommended		
	Top-bottom Misalignment	Left-right Misalignment	Front-rear Misalignment
<p>Top Blade</p> <p>Bottom Blade</p>	<p>Top Blade</p> <p>Bottom Blade</p>	<p>Top Blade</p> <p>Bottom Blade</p>	<p>Top Blade</p> <p>Bottom Blade</p>



■ Others

1. Under Operation of Equipment

- 1-1. Do not touch a capacitor directly with bare hands during operation in order to avoid the danger of a electric shock.
- 1-2. Do not allow the terminals of a capacitor to come in contact with any conductive objects (short-circuit). Do not expose a capacitor to a conductive liquid, inducing any acid or alkali solutions.
- 1-3. Confirm the environment in which the equipment will operation is under the specified conditions. Do not use the equipment under the following environment.
 - (1) Being spattered with water or oil.
 - (2) Being exposed to direct sunlight.
 - (3) Being exposed to Ozone, ultraviolet rays or radiation.
 - (4) Being exposed to toxic gas (e.g., hydrogen sulfide, sulfur dioxide, chlorine, ammonia gas, etc.)
 - (5) Any vibrations or mechanical shocks exceeding the specified limits.
 - (6) Moisture condensing environments.
- 1-4. Use damp proof countermeasures if using under any conditions that can cause condensation.

2. Others

- 2-1. In an Emergency
 - (1) If the equipment should generate smoke, fire or smell, immediately turn off or unplug the equipment.

If the equipment is not turned off or unplugged, the hazards may be worsened by supplying continuous power.

- (2) In this type of situation, do not allow face and hands to come in contact with the capacitor or burns may be caused by the capacitors high temperature.

2-2. Disposal of Waste

When capacitors are disposed, they must be burned or buried by the industrial waste vender with the appropriate licenses.

2-3. Circuit Design

GRM, GCM, GMA/D, LLL/A/M, ERB, GQM, GJM, GNM Series capacitors in this catalog are not safety certified products.

2-4. Remarks

Failure to follow the cautions may result, worst case, in a short circuit and smoking when the product is used.

The above notices are for standard applications and conditions. Contact us when the products are used in special mounting conditions.

Select optimum conditions for operation as they determine the reliability of the product after assembly.

The data herein are given in typical values, not guaranteed ratings.

Notice

■ Rating

1. Operating Temperature

1. The operating temperature limit depends on the capacitor.

- 1-1. Do not apply temperatures exceeding the upper operating temperature.

It is necessary to select a capacitor with a suitable rated temperature which will cover the operating temperature range.

Also it is necessary to consider the temperature distribution in equipment and the seasonal temperature variable factor.

- 1-2. Consider the self-heating of the capacitor

The surface temperature of the capacitor shall be the upper operating temperature or less when including the self-heating factors.

2. Atmosphere Surroundings (gaseous and liquid)

1. Restriction on the operating environment of capacitors.

- 1-1. The capacitor, when used in the above, unsuitable, operating environments may deteriorate due to the corrosion of the terminations and the penetration of moisture into the capacitor.

- 1-2. The same phenomenon as the above may occur when the electrodes or terminals of the capacitor are subject to moisture condensation.

- 1-3. The deterioration of characteristics and insulation resistance due to the oxidization or corrosion of terminal electrodes may result in breakdown when the capacitor is exposed to corrosive or volatile gases or solvents for long periods of time.

3. Piezo-electric Phenomenon

1. When using high dielectric constant type capacitors in AC or pulse circuits, the capacitor itself vibrates at specific frequencies and noise may be generated. Moreover, when the mechanical vibration or shock is added to capacitor, noise may occur.

Notice

■ Soldering and Mounting

1. PCB Design

1. Notice for Pattern Forms

- 1-1. Unlike leaded components, chip components are susceptible to flexing stresses since they are mounted directly on the substrate. They are also more sensitive to mechanical and thermal stresses than leaded components. Excess solder fillet height can multiply these stresses and cause chip cracking. When designing substrates, take land patterns and dimensions into consideration to eliminate the possibility of excess solder fillet height.
- 1-2. It is possible for the chip to crack by the expansion and shrinkage of a metal board. Please contact us if you want to use our ceramic capacitors on a metal board such as Aluminum.

Pattern Forms

	Prohibited	Correct
Placing Close to Chassis		
Placing of Chip Components and Leaded Components		
Placing of Leaded Components after Chip Component		
Lateral Mounting		

Continued on the following page.

Notice

☒ Continued from the preceding page.

2. Land Dimensions

- 2-1. Chip capacitor can be cracked due to the stress of PCB bending / etc if the land area is larger than needed and has an excess amount of solder. Please refer to the land dimensions in table 1 for flow soldering, table 2 for reflow soldering, table 3 for GNM & LLA, and table 4 for LLM. Please confirm the suitable land dimension by evaluating of the actual SET / PCB.

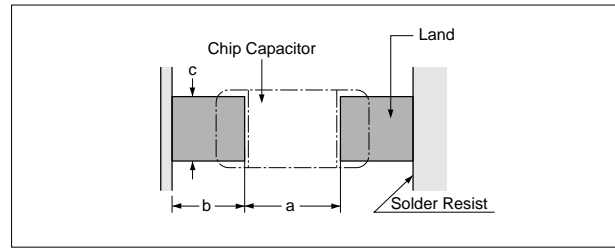

Table 1 Flow Soldering Method

Part Number	Dimensions	Chip (L×W)	a	b	c
GRM18 QQM18		1.6×0.8	0.6 to 1.0	0.8 to 0.9	0.6 to 0.8
GRM21 QQM21		2.0×1.25	1.0 to 1.2	0.9 to 1.0	0.8 to 1.1
GRM31		3.2×1.6	2.2 to 2.6	1.0 to 1.1	1.0 to 1.4
LLL21		1.25×2.0	0.4 to 0.7	0.5 to 0.7	1.4 to 1.8
LLL31		1.6×3.2	0.6 to 1.0	0.8 to 0.9	2.6 to 2.8
ERB11		1.25×1.0	0.4 to 0.6	0.6 to 0.8	0.8 to 1.0
ERB21		2.0×1.25	1.0 to 1.2	0.9 to 1.0	0.8 to 1.0
ERF1D		1.4×1.4	0.5 to 0.8	0.8 to 0.9	1.0 to 1.2

(in mm)

Table 2 Reflow Soldering Method

Part Number	Dimensions	Chip (L×W)	a	b	c
GRM02		0.4×0.2	0.16 to 0.2	0.12 to 0.18	0.2 to 0.23
GRM03 GJM03		0.6×0.3	0.2 to 0.3	0.2 to 0.35	0.2 to 0.4
GRM15 GJM15		1.0×0.5	0.3 to 0.5	0.35 to 0.45	0.4 to 0.6
GRM18 QQM18		1.6×0.8	0.6 to 0.8	0.6 to 0.7	0.6 to 0.8
GRM21 QQM21		2.0×1.25	1.0 to 1.2	0.6 to 0.7	0.8 to 1.1
GRM31		3.2×1.6	2.2 to 2.4	0.8 to 0.9	1.0 to 1.4
GRM32		3.2×2.5	2.0 to 2.4	1.0 to 1.2	1.8 to 2.3
GRM43		4.5×3.2	3.0 to 3.5	1.2 to 1.4	2.3 to 3.0
GRM55		5.7×5.0	4.0 to 4.6	1.4 to 1.6	3.5 to 4.8
LLL15		0.5×1.0	0.15 to 0.2	0.2 to 0.25	0.7 to 1.0
LLL18		0.8×1.6	0.2 to 0.3	0.3 to 0.4	1.4 to 1.6
LLL21		1.25×2.0	0.4 to 0.6	0.4 to 0.5	1.4 to 1.8
LLL31		1.6×3.2	0.6 to 0.8	0.6 to 0.7	2.6 to 2.8
ERB11		1.25×1.0	0.4 to 0.6	0.6 to 0.8	0.8 to 1.0
ERB21		2.0×1.25	1.0 to 1.2	0.6 to 0.8	0.8 to 1.0
ERB32		3.2×2.5	2.2 to 2.5	0.8 to 1.0	1.9 to 2.3
ERF1D		1.4×1.4	0.4 to 0.8	0.6 to 0.8	1.0 to 1.2
ERF22		2.8×2.8	1.8 to 2.1	0.7 to 0.9	2.2 to 2.6

(in mm)

Continued on the following page. ☒

Notice

Continued from the preceding page.

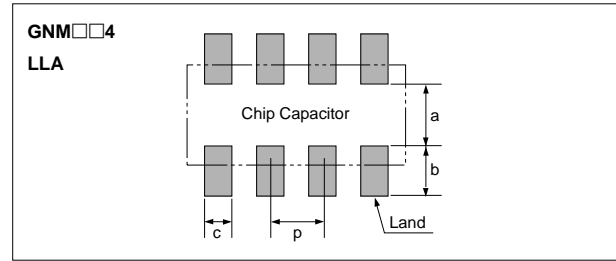
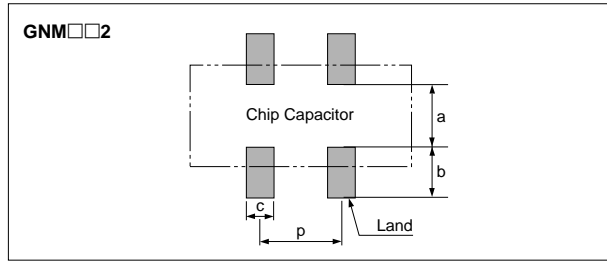

Table 3 GNM, LLA Series for Reflow Soldering Land Dimensions

Part Number	Dimensions (mm)					
	L	W	a	b	c	p
GNM0M2	0.9	0.6	0.12 to 0.20*	0.35 to 0.40*	0.3	0.45
GNM1M2	1.37	1.0	0.4 to 0.5	0.35 to 0.45	0.3 to 0.35	0.64
GNM212	2.0	1.25	0.6 to 0.7	0.5 to 0.7	0.4 to 0.5	1.0
GNM214	2.0	1.25	0.6 to 0.7	0.5 to 0.7	0.25 to 0.35	0.5
GNM314	3.2	1.6	0.8 to 1.0	0.7 to 0.9	0.3 to 0.4	0.8
LLA18	1.6	0.8	0.3 to 0.4	0.25 to 0.35	0.15 to 0.25	0.4
LLA21	2.0	1.25	0.5 to 0.7	0.35 to 0.6	0.2 to 0.3	0.5
LLA31	3.2	1.6	0.7 to 0.9	0.4 to 0.7	0.3 to 0.4	0.8

* $0.82 \leq a+2b \leq 1.00$

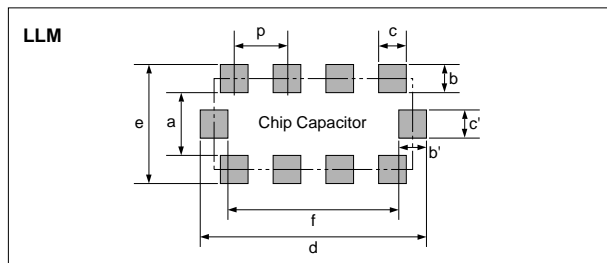

Table 4 LLM Series for Reflow Soldering Land Dimensions

Part Number	Dimensions (mm)						
	a	b, b'	c, c'	d	e	f	p
LLM21	0.6 to 0.8	(0.3 to 0.5)	0.3	2.0 to 2.6	1.3 to 1.8	1.4 to 1.6	0.5
LLM31	1.0	(0.3 to 0.5)	0.4	3.2 to 3.6	1.6 to 2.0	2.6	0.8

$b=(c-e)/2, b'=(d-f)/2$

2. Adhesive Application

- Thin or insufficient adhesive can cause the chips to loosen or become disconnected during flow soldering. The amount of adhesive must be more than dimension c, shown in the drawing at right, to obtain the correct bonding strength. The chip's electrode thickness and land thickness must also be taken into consideration.
- Low viscosity adhesive can cause chips to slip after mounting. The adhesive must have a viscosity of 5000Pa · s (500ps) min. (at 25°C).

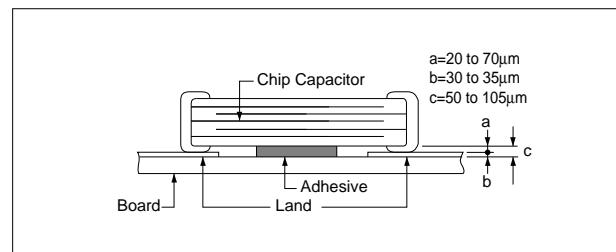

3. Adhesive Coverage

Part Number	Adhesive Coverage*
GRM18, GQM18	0.05mg min.
GRM21, LLL21, GQM21	0.1mg min.
GRM31, LLL31	0.15mg min.

*Nominal Value

Continued on the following page.

Notice

☒ Continued from the preceding page.

3. Adhesive Curing

1. Insufficient curing of the adhesive can cause chips to disconnect during flow soldering and causes deterioration in the insulation resistance between the outer electrodes due to moisture absorption.
Control curing temperature and time in order to prevent insufficient hardening.

4. Flux Application

1. An excessive amount of flux generates a large quantity of flux gas, which can cause a deterioration of Solderability. So apply flux thinly and evenly throughout. (A foaming system is generally used for flow soldering).
2. Flux containing too a high percentage of halide may cause corrosion of the outer electrodes unless there is sufficient cleaning. Use flux with a halide content of 0.2% max.

3. Do not use strong acidic flux.

4. Do not use water-soluble flux.

(*Water-soluble flux can be defined as non rosin type flux including wash-type flux and non-wash-type flux.)

5. Flow Soldering

- Set temperature and time to ensure that leaching of the outer electrode does not exceed 25% of the chip end area as a single chip (full length of the edge A-B-C-D shown right) and 25% of the length A-B shown below as mounted on substrate.

[As a Single Chip]

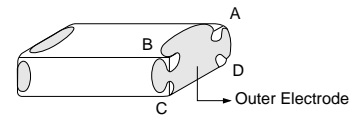

[As Mounted on Substrate]

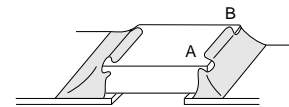

6. Washing

1. Please evaluate a capacitor by actual cleaning equipment and condition surely for confirming the quality and select the applicable solvent.
2. Unsuitable cleaning solvent may leave residual flux, other foreign substances, causing deterioration of electrical characteristics and the reliability of the capacitors.

3. Select the proper cleaning conditions.

- 3-1. Improper cleaning conditions (excessive or insufficient) may result in the deterioration of the performance of the capacitors.

Continued on the following page. ☒

Notice

☒ Continued from the preceding page.

7. Coating

1. A crack may be caused in the capacitor due to the stress of the thermal contraction of the resin during curing process.

The stress is affected by the amount of resin and curing contraction.

Select a resin with small curing contraction.

The difference in the thermal expansion coefficient between a coating resin or a molding resin and capacitor may cause the destruction and deterioration of the capacitor such as a crack or peeling, and lead to the deterioration of insulation resistance or dielectric breakdown.

Select a resin for which the thermal expansion coefficient is as close to that of capacitor as possible.

A silicone resin can be used as an under-coating to buffer against the stress.

2. Select a resin that is less hygroscopic.

Using hygroscopic resins under high humidity conditions may cause the deterioration of the insulation resistance of a capacitor.

An epoxy resin can be used as a less hygroscopic resin.

8. Die Bonding/Wire Bonding (GMA or GMD Series)

1. Die Bonding of Capacitors

- Use the following materials for the Brazing alloys:
Au-Sn (80/20) 300 to 320 degree C in N₂ atmosphere
- Mounting
 - (1) Control the temperature of the substrate so it matches the temperature of the brazing alloy.
 - (2) Place the brazing alloy on the substrate and place the capacitor on the alloy. Hold the capacitor and gently apply the load. Be sure to complete the operation within 1 minute.

2. Wire Bonding

- Wire
Gold wire: 25 micro m (0.001 inch) diameter
- Bonding
 - (1) Thermo compression, ultrasonic ball bonding.
 - (2) Required stage temperature: 150 to 200 degree C
 - (3) Required wedge or capillary weight: 0.2N to 0.5N
 - (4) Bond the capacitor and base substrate or other devices with gold wire.

Notice

■ Others

1. Transportation

1. The performance of a capacitor may be affected by the conditions during transportation.

1-1. The capacitors shall be protected against excessive temperature, humidity and mechanical force during transportation.

(1) Climatic condition

- low air temperature: -40°C
- change of temperature air/air: $-25^{\circ}\text{C}/+25^{\circ}\text{C}$
- low air pressure: 30 kPa
- change of air pressure: 6 kPa/min.

(2) Mechanical condition

Transportation shall be done in such a way that the boxes are not deformed and forces are not directly passed on to the inner packaging.

1-2. Do not apply excessive vibration, shock, and pressure to the capacitor.

- (1) When excessive mechanical shock or pressure is applied to a capacitor, chipping or cracking may occur in the ceramic body of the capacitor.
- (2) When a sharp edge of an air driver, a soldering iron, tweezers, a chassis, etc. impacts strongly on the surface of capacitor, the capacitor may crack and short-circuit.

1-3. Do not use a capacitor to which excessive shock was applied by dropping, etc.

The capacitor dropped accidentally during processing may be damaged.

Reference Data

1. Solderability

(1) Test Method

Subject the chip capacitor to the following conditions.
 Then apply flux (an ethanol solution of 25% rosin) to the chip and dip it in 230°C eutectic solder for 2 seconds.
 Conditions:
 Expose prepared at room temperature (for 6 months and 12 months, respectively)
 Prepared at high temperature (for 100 hours at 85°C)
 Prepared left at high humidity (for 100 hours under 90%RH to 95%RH at 40°C)

(2) Test Samples

GRM21 : Products for flow/reflow soldering.

(3) Acceptance Criteria

With a 60-power optical microscope, measure the surface area of the outer electrode that is covered with solder.

(4) Results

Refer to Table 1.

Table 1

Sample	Initial State	Prepared at Room Temperature		Prepared at High Temperature for 100 Hours at 85°C	Prepared at High Humidity for 100 Hours at 90 to 95% RH and 40°C
		6 months	12 months		
GRM21 for flow/reflow soldering	95 to 100%	95 to 100%	95%	90 to 95%	95%

2. Board Bending Strength for Solder Fillet Height

(1) Test Method

Solder the chip capacitor to the test PCB with the amount of solder paste necessary to achieve the fillet heights.
 Then bend the PCB using the method illustrated and measure capacitance.

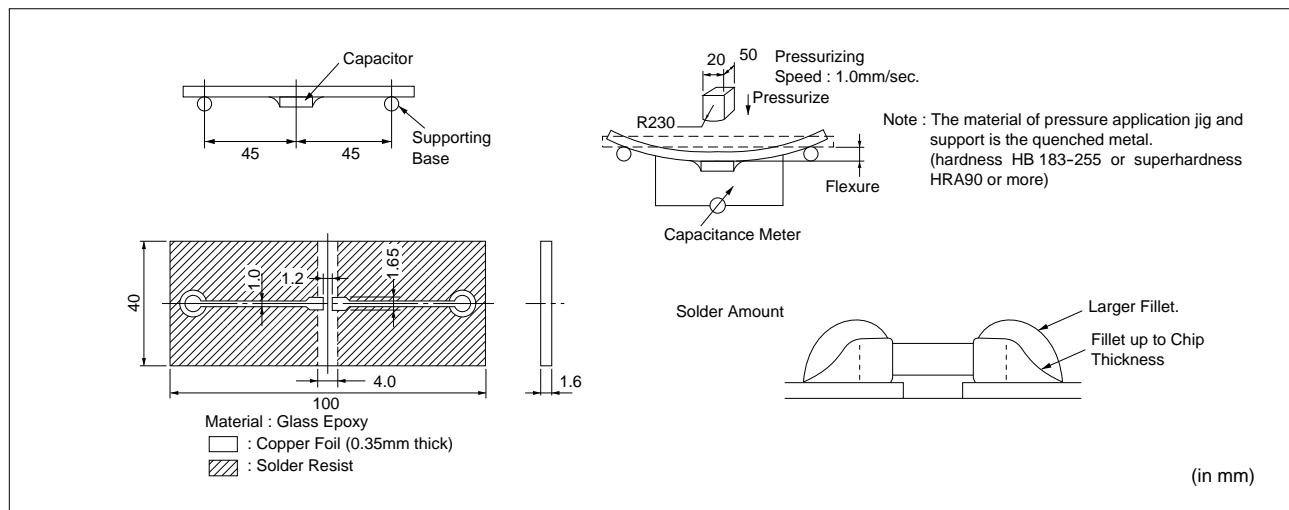

(2) Test Samples

GRM21: 5C/R7/F5 Characteristics T=0.6mm

(3) Acceptance Criteria

Products should be determined to be defective if the change in capacitance has exceeded the values specified in Table 2.

Table 2

Characteristics	Change in Capacitance
5C	Within $\pm 5\%$ or $\pm 0.5\text{pF}$, whichever is greater
R7	Within $\pm 12.5\%$
F5	Within $\pm 20\%$

Continued on the following page. ↗

Reference Data

☒ Continued from the preceding page.

(4) Results

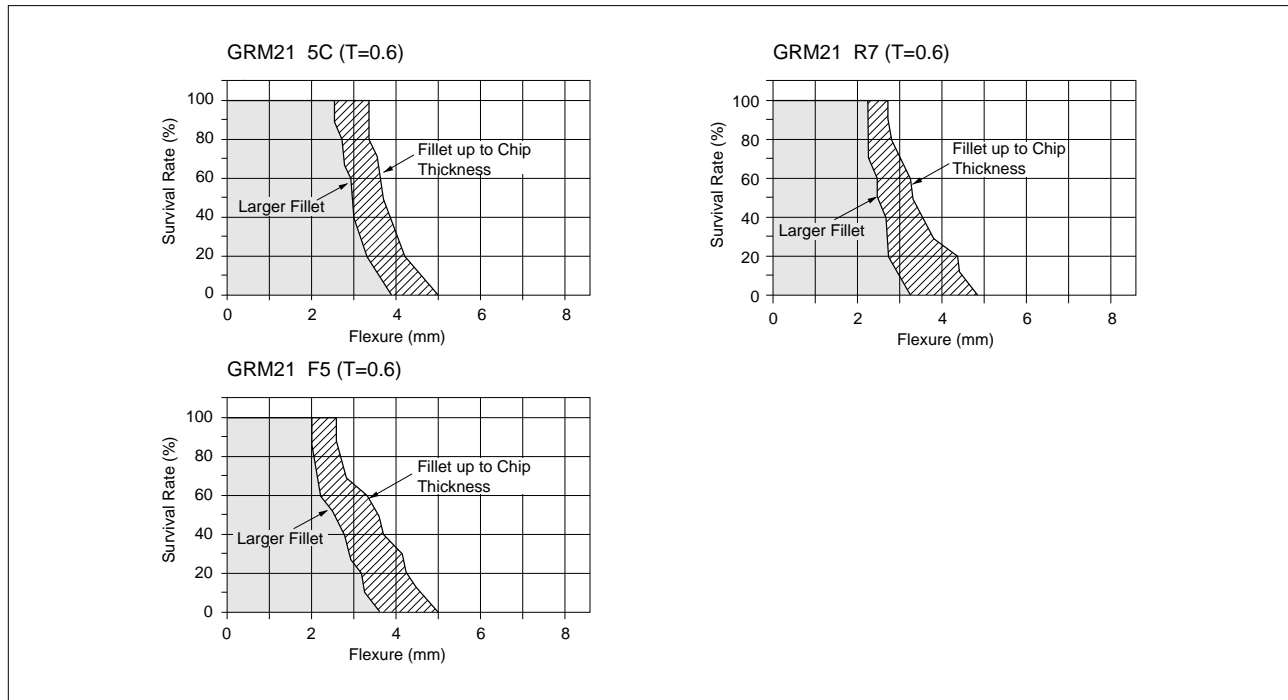

3. Temperature Cycling for Solder Fillet Height

(1) Test Method

Solder the chips to the substrate of various test fixtures using sufficient amounts of solder to achieve the required fillet height. Then subject the fixtures to the cycle illustrated below 200 times.

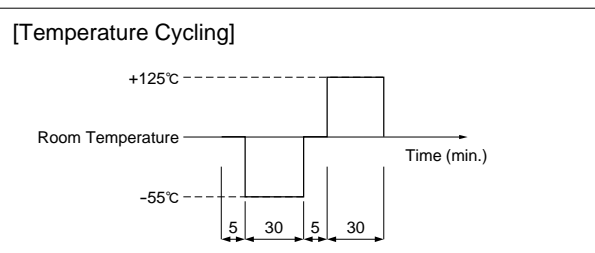

① Solder Amount

Alumina substrates are typically designed for reflow soldering.
 Glass epoxy or paper phenol substrates are typically used for flow soldering.

② Material

Alumina (Thickness: 0.64mm)
 Glass epoxy (Thickness: 1.64mm)
 Paper phenol (Thickness: 1.64mm)

[Solder Amount]

Substrate		Alumina	Glass Epoxy or Paper Phenol
Solder Amount	①		
	②		
	③		
Solder to be used		6X4 Eutectic solder	

③ Land Dimension

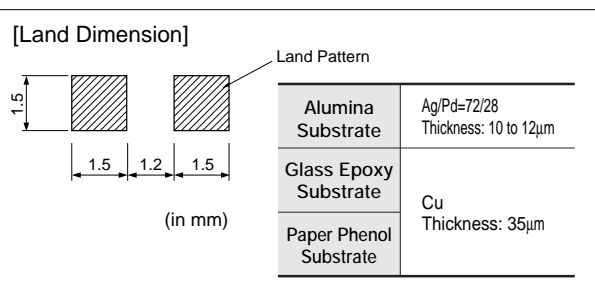

Continued on the following page. ☒

Reference Data

Continued from the preceding page.

(2) Test Samples

GRM21 5C/R7/F5 Characteristics T=0.6mm

(3) Acceptance Criteria

Products are determined to be defective if the change in capacitance has exceeded the values specified in Table 3.

Table 3

Characteristics	Change in Capacitance
5C	Within $\pm 2.5\%$ or $\pm 0.25\text{pF}$, whichever is greater
R7	Within $\pm 7.5\%$
F5	Within $\pm 20\%$

(4) Results

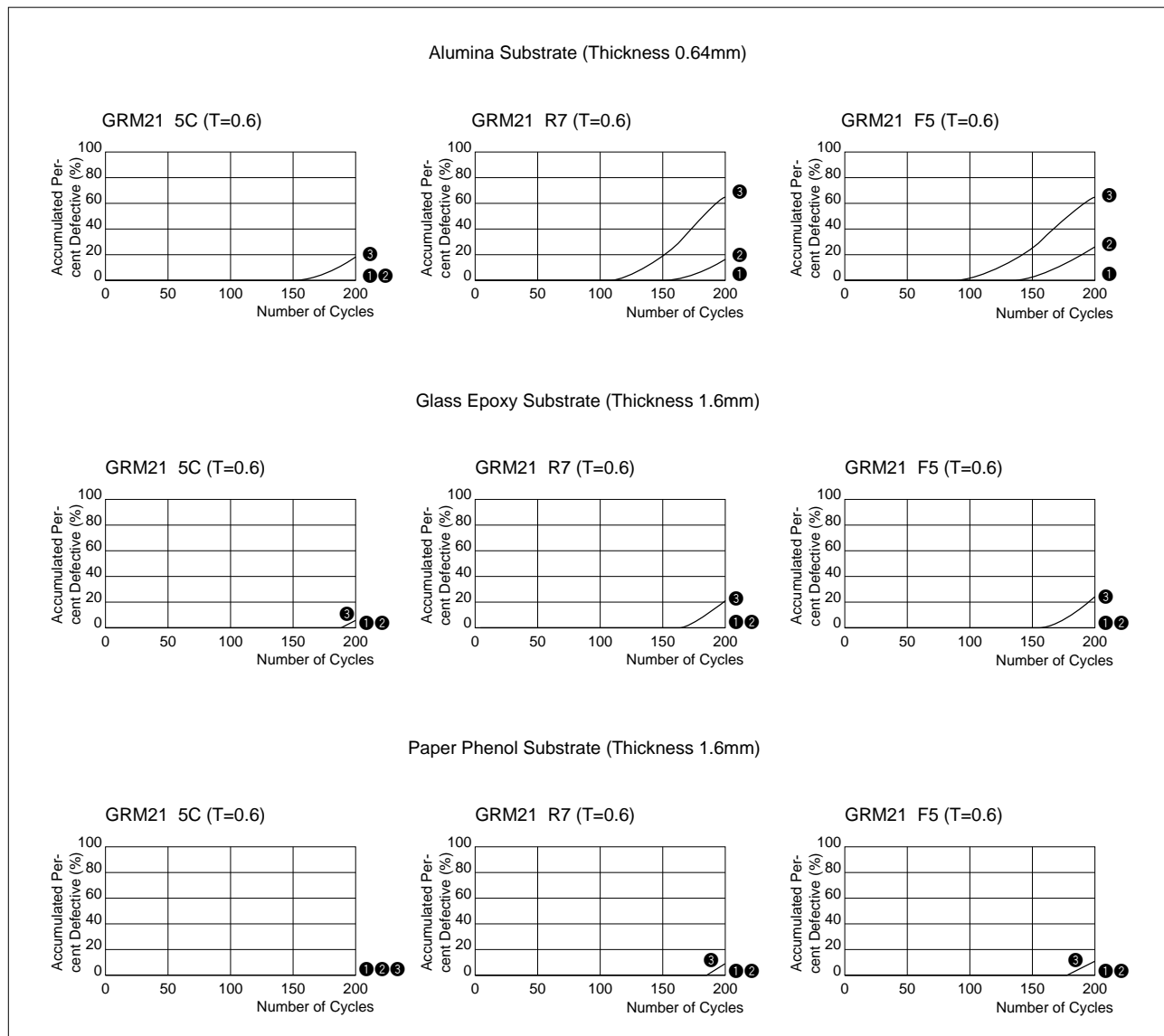

Continued on the following page. ↗

Reference Data

☒ Continued from the preceding page.

4. Board Bending Strength for Board Material

(1) Test Method

Solder the chip to the test board. Then bend the board using the method illustrated below, to measure capacitance.

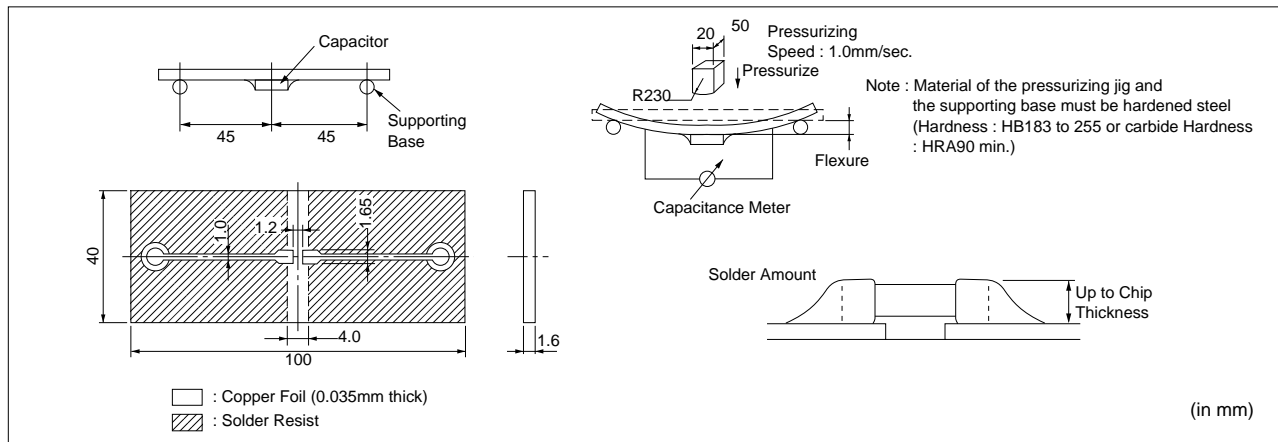

(2) Test Samples

GRM21 5C/R7/F5 Characteristics T=0.6mm typical

(3) Acceptance Criteria

Products should be determined to be defective if the change in capacitance has exceeded the values specified in Table 4.

Table 4

Characteristics	Change in Capacitance
5C	Within $\pm 5\%$ or $\pm 0.5\text{pF}$, whichever is greater
R7	Within $\pm 12.5\%$
F5	Within $\pm 20\%$

(4) Results

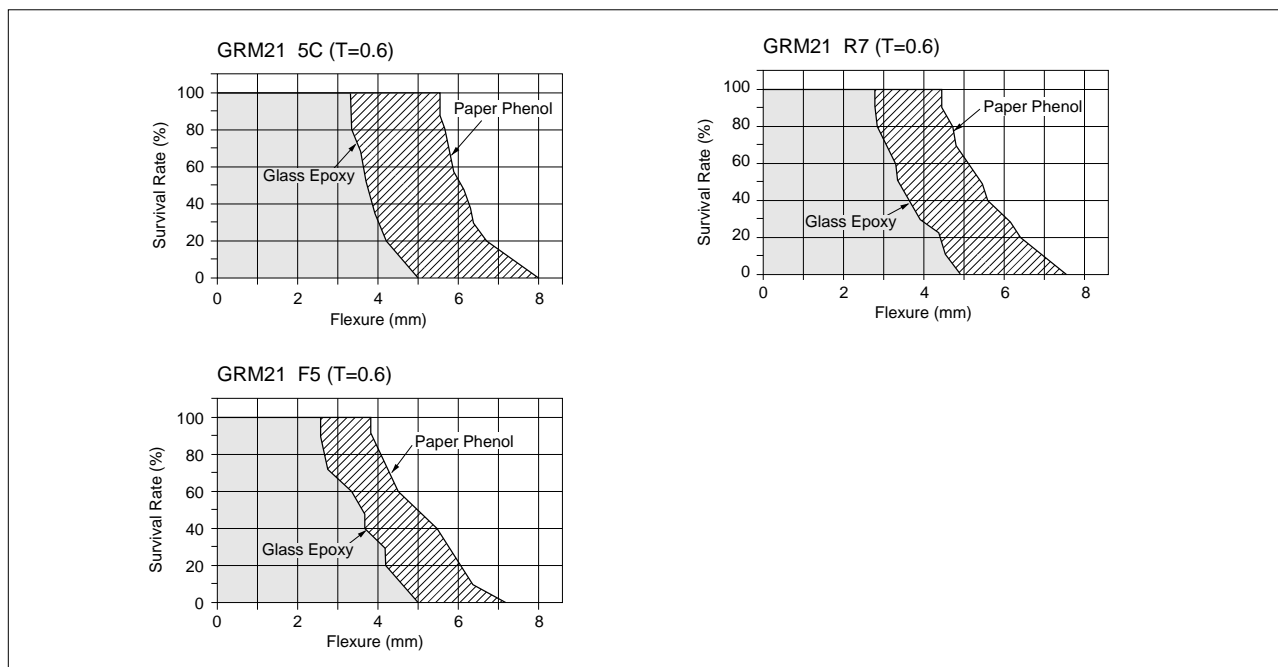

Continued on the following page. ☞

Reference Data

Continued from the preceding page.

5. Break Strength

(1) Test Method

Place the chip on a steel plate as illustrated on the right. Increase load applied to a point near the center of the test sample.

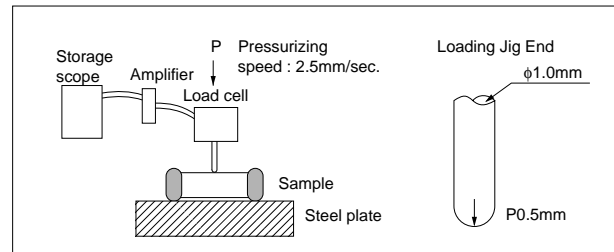

(2) Test Samples

GRM21 5C/R7/F5 Characteristics
GRM31 5C/R7/F5 Characteristics

(3) Acceptance Criteria

Define the load that has caused the chip to break or crack, as the bending force.

(4) Explanation

Break strength, P, is proportionate to the square of the thickness of the ceramic element and is expressed as a curve of secondary degree.

The formula is:

$$P = \frac{2\gamma WT^2}{3L} \quad (\text{N})$$

W : Width of ceramic element (mm)

T : Thickness of element (mm)

L : Distance between fulcrums (mm)

γ : Bending stress (N/mm²)

Chip Size	L	W	γ		
			5C Characteristics	R7 Characteristics	F5 Characteristics
GRM21	1.5	1.2	300	180	160
GRM31	2.7	1.5			

(in mm)

(5) Results

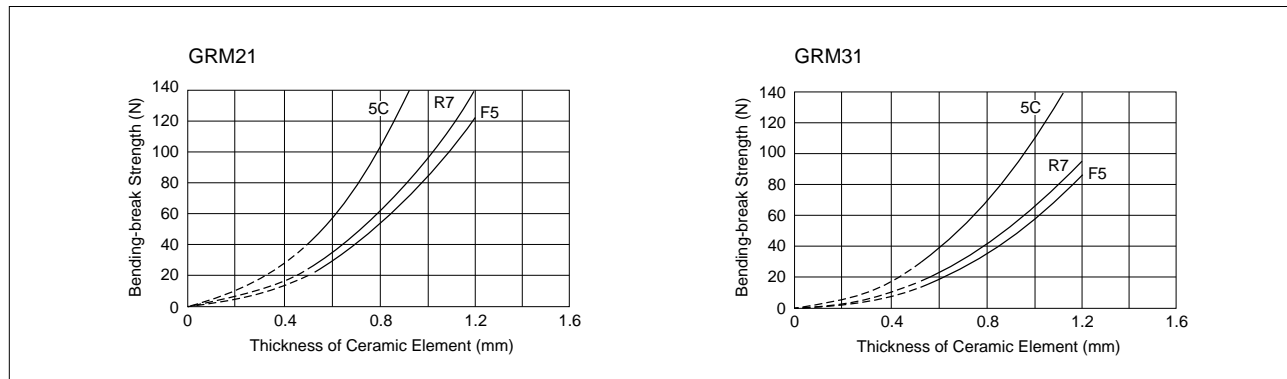

6. Thermal Shock

(1) Test method

After applying flux (an ethanol solution of 25% rosin), dip the chip in a solder bath (6X4 eutectic solder) in accordance with the following conditions:

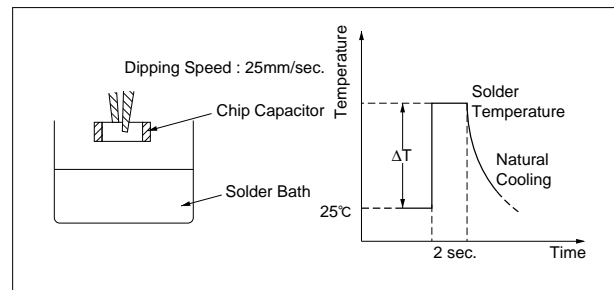

(2) Test samples

GRM21 5C/R7/F5 Characteristics T=0.6mm typical

(3) Acceptance criteria

Visually inspect the test sample with a 60-power optical microscope. Chips exhibiting breaks or cracks should be determined to be defective.

Continued on the following page. ↗

Reference Data

Continued from the preceding page.

(4) Results

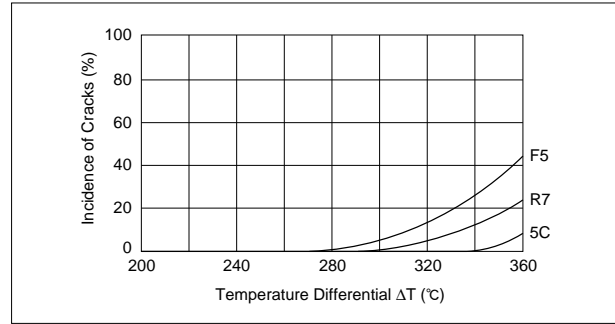

7. Solder Heat Resistance

(1) Test Method

- ① Reflow soldering:
Apply about 300 μm of solder paste over the alumina substrate. After reflow soldering, remove the chip and check for leaching that may have occurred on the outer electrode.
- ② Flow soldering:
After dipping the test sample with a pair of tweezers in wave solder (eutectic solder), check for leaching that may have occurred on the outer electrode.

- ③ Dip soldering:
After dipping the test sample with a pair of tweezers in static solder (eutectic solder), check for leaching that may have occurred on the outer electrode.
- ④ Flux to be used: An ethanol solution of 25% rosin.

(2) Test samples

GRM21: For flow/reflow soldering T=0.6mm

(3) Acceptance criteria

The starting time of leaching should be defined as the time when the outer electrode has lost 25% of the total edge length of A-B-C-D as illustrated:

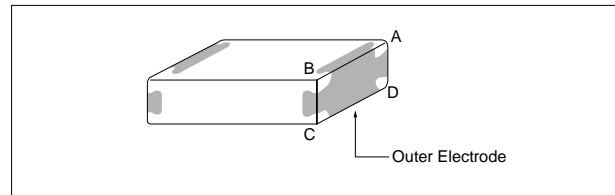

(4) Results

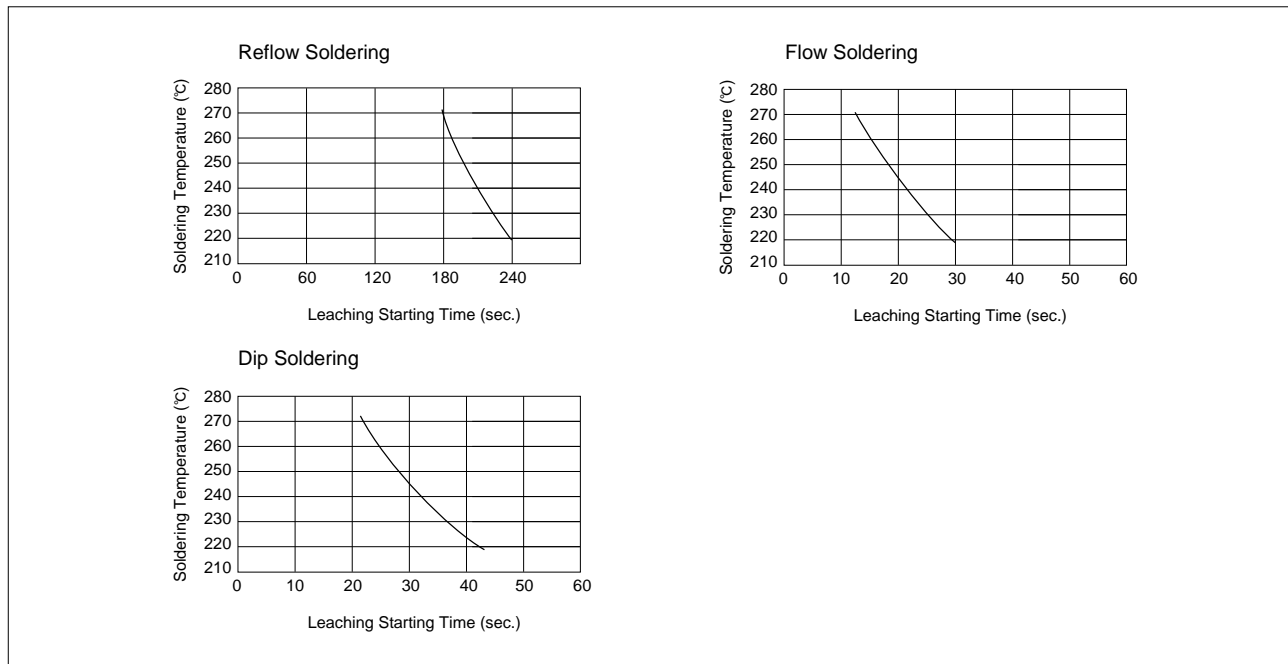

Continued on the following page. ↗

Reference Data

☒ Continued from the preceding page.

8. Thermal Shock when Making Corrections with a Soldering Iron

(1) Test Method

Apply a soldering iron meeting the conditions below to the soldered joint of a chip that has been soldered to a paper phenol board, while supplying wire solder. (Note: the soldering iron tip should not directly touch the ceramic element of the chip.)

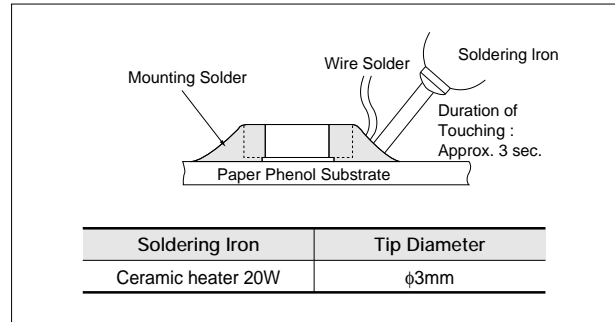

(2) Test Samples

GRM21 5C/R7/F5 Characteristics T=0.6mm

(3) Acceptance Criteria for Defects

Observe the appearance of the test sample with a 60-power optical microscope. Those units displaying any breaks or cracks are determined to be defective.

(4) Results

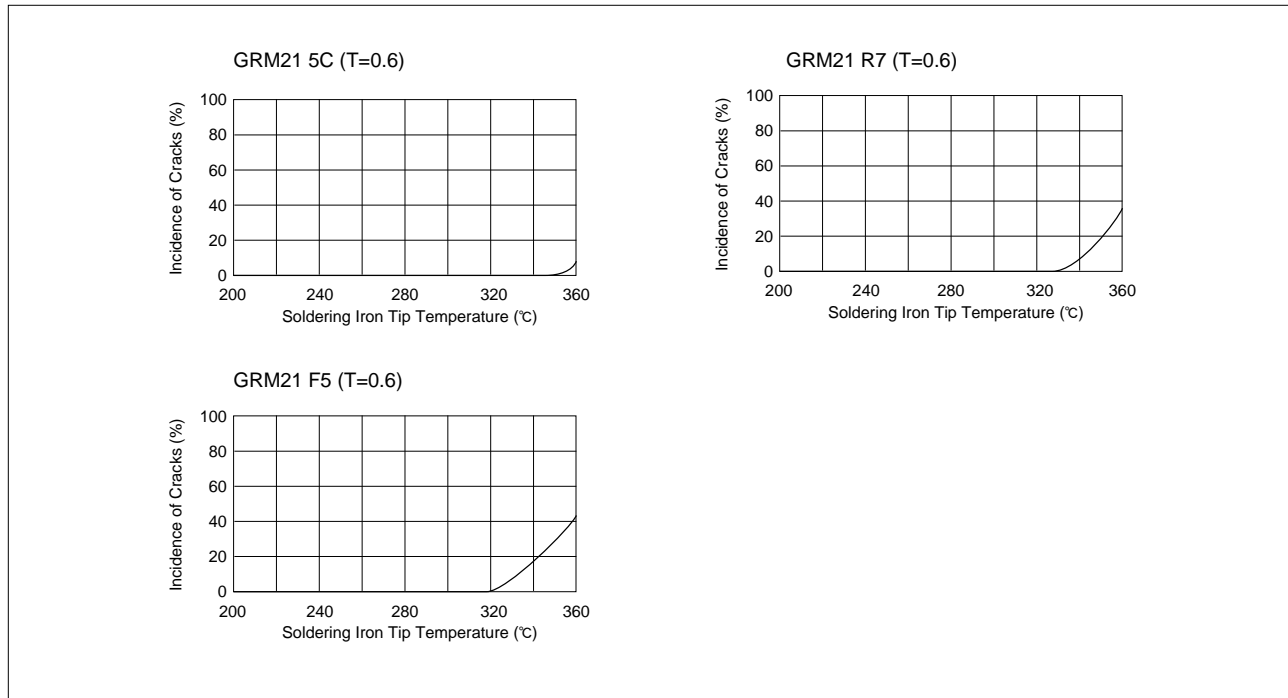

Chip Monolithic Ceramic Capacitors



Medium Voltage Low Dissipation Factor

■ Features

1. Low-loss and suitable for high frequency circuits
2. Murata's original internal electrode structure realizes high flash-over voltage.
3. A new monolithic structure for small, surface-mountable devices capable of operating at high voltage levels
4. Sn-plated external electrodes realize good solderability.
5. Use the GRM21/31 type with flow or reflow soldering, and other types with reflow soldering only.

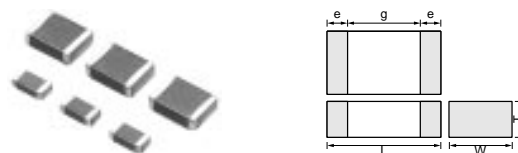

Part Number	Dimensions (mm)				
	L	W	T	e min.	g min.
GRM21A	2.0 ±0.2	1.25 ±0.2	1.0 +0, -0.3	0.3	0.7
GRM31A	3.2 ±0.2	1.6 ±0.2	1.25 +0, -0.3		1.5*
GRM31B			1.0 +0, -0.3		
GRM32A	3.2 ±0.2	2.5 ±0.2	1.25 +0, -0.3		
GRM32B			1.0 +0, -0.3		
GRM42A	4.5 ±0.3	2.0 ±0.2	1.0 +0, -0.3		

* GRM31A7U3D, GRM32A7U3D, GRM32B7U3D : 1.8mm min.

■ Applications

Ideal for use on high frequency pulse circuits such as snubber circuits for switching power supplies, DC-DC converters, ballasts (inverter fluorescent lamps), etc.

9

Do not use these products in any Automotive Power train or Safety equipment including Battery charger for Electric Vehicles and Plug-in Hybrid. Only Murata products clearly stipulated as "for Automotive use" on its catalog can be used for automobile applications such as Power train and Safety equipment.

*: In case of use C0G char., DC630V product with pulse voltage, be sure not to use with 10kHz and less pulse or ripple voltage condition. and these product are not suitable for commercial power line voltage application, such as AC filter. For those applications, be sure to use AC voltage rating product.(GA2/GA3 series)

C0G Characteristics

Part Number	Rated Voltage (V)	TC Code (Standard)	Capacitance (pF)	Length L (mm)	Width W (mm)	Thickness T (mm)	Electrode g min. (mm)	Electrode e (mm)
GRM31A5C2J101JW01D	DC630	C0G (EIA)	100 ±5%	3.2	1.6	1.0	1.5	0.3 min.
GRM31A5C2J121JW01D	DC630	C0G (EIA)	120 ±5%	3.2	1.6	1.0	1.5	0.3 min.
GRM31A5C2J151JW01D	DC630	C0G (EIA)	150 ±5%	3.2	1.6	1.0	1.5	0.3 min.
GRM31A5C2J181JW01D	DC630	C0G (EIA)	180 ±5%	3.2	1.6	1.0	1.5	0.3 min.
GRM31A5C2J221JW01D	DC630	C0G (EIA)	220 ±5%	3.2	1.6	1.0	1.5	0.3 min.
GRM31A5C2J271JW01D	DC630	C0G (EIA)	270 ±5%	3.2	1.6	1.0	1.5	0.3 min.
GRM31A5C2J331JW01D	DC630	C0G (EIA)	330 ±5%	3.2	1.6	1.0	1.5	0.3 min.
GRM31A5C2J391JW01D	DC630	C0G (EIA)	390 ±5%	3.2	1.6	1.0	1.5	0.3 min.
GRM31A5C2J471JW01D	DC630	C0G (EIA)	470 ±5%	3.2	1.6	1.0	1.5	0.3 min.
GRM31A5C2J561JW01D	DC630	C0G (EIA)	560 ±5%	3.2	1.6	1.0	1.5	0.3 min.
GRM31B5C2J681JW01L	DC630	C0G (EIA)	680 ±5%	3.2	1.6	1.25	1.5	0.3 min.
GRM31B5C2J821JW01L	DC630	C0G (EIA)	820 ±5%	3.2	1.6	1.25	1.5	0.3 min.
GRM31B5C2J102JW01L	DC630	C0G (EIA)	1000 ±5%	3.2	1.6	1.25	1.5	0.3 min.

U2J Characteristics

Part Number	Rated Voltage (V)	TC Code (Standard)	Capacitance (pF)	Length L (mm)	Width W (mm)	Thickness T (mm)	Electrode g min. (mm)	Electrode e (mm)
GRM21A7U2E101JW31D	DC250	U2J (EIA)	100 ±5%	2.0	1.25	1.0	0.7	0.3 min.
GRM21A7U2E121JW31D	DC250	U2J (EIA)	120 ±5%	2.0	1.25	1.0	0.7	0.3 min.
GRM21A7U2E151JW31D	DC250	U2J (EIA)	150 ±5%	2.0	1.25	1.0	0.7	0.3 min.
GRM21A7U2E181JW31D	DC250	U2J (EIA)	180 ±5%	2.0	1.25	1.0	0.7	0.3 min.
GRM21A7U2E221JW31D	DC250	U2J (EIA)	220 ±5%	2.0	1.25	1.0	0.7	0.3 min.
GRM21A7U2E271JW31D	DC250	U2J (EIA)	270 ±5%	2.0	1.25	1.0	0.7	0.3 min.
GRM21A7U2E331JW31D	DC250	U2J (EIA)	330 ±5%	2.0	1.25	1.0	0.7	0.3 min.
GRM21A7U2E391JW31D	DC250	U2J (EIA)	390 ±5%	2.0	1.25	1.0	0.7	0.3 min.
GRM21A7U2E471JW31D	DC250	U2J (EIA)	470 ±5%	2.0	1.25	1.0	0.7	0.3 min.
GRM21A7U2E561JW31D	DC250	U2J (EIA)	560 ±5%	2.0	1.25	1.0	0.7	0.3 min.
GRM21A7U2E681JW31D	DC250	U2J (EIA)	680 ±5%	2.0	1.25	1.0	0.7	0.3 min.
GRM21A7U2E821JW31D	DC250	U2J (EIA)	820 ±5%	2.0	1.25	1.0	0.7	0.3 min.
GRM21A7U2E102JW31D	DC250	U2J (EIA)	1000 ±5%	2.0	1.25	1.0	0.7	0.3 min.
GRM21A7U2E122JW31D	DC250	U2J (EIA)	1200 ±5%	2.0	1.25	1.0	0.7	0.3 min.
GRM21A7U2E152JW31D	DC250	U2J (EIA)	1500 ±5%	2.0	1.25	1.0	0.7	0.3 min.
GRM21A7U2E182JW31D	DC250	U2J (EIA)	1800 ±5%	2.0	1.25	1.0	0.7	0.3 min.
GRM21A7U2E222JW31D	DC250	U2J (EIA)	2200 ±5%	2.0	1.25	1.0	0.7	0.3 min.
GRM31A7U2E272JW31D	DC250	U2J (EIA)	2700 ±5%	3.2	1.6	1.0	1.5	0.3 min.
GRM31A7U2E332JW31D	DC250	U2J (EIA)	3300 ±5%	3.2	1.6	1.0	1.5	0.3 min.
GRM31A7U2E392JW31D	DC250	U2J (EIA)	3900 ±5%	3.2	1.6	1.0	1.5	0.3 min.
GRM31A7U2E472JW31D	DC250	U2J (EIA)	4700 ±5%	3.2	1.6	1.0	1.5	0.3 min.
GRM31A7U2E562JW31D	DC250	U2J (EIA)	5600 ±5%	3.2	1.6	1.0	1.5	0.3 min.
GRM31B7U2E682JW31L	DC250	U2J (EIA)	6800 ±5%	3.2	1.6	1.25	1.5	0.3 min.
GRM31B7U2E822JW31L	DC250	U2J (EIA)	8200 ±5%	3.2	1.6	1.25	1.5	0.3 min.
GRM31B7U2E103JW31L	DC250	U2J (EIA)	10000 ±5%	3.2	1.6	1.25	1.5	0.3 min.
GRM31A7U2J100JW31D	DC630	U2J (EIA)	10 ±5%	3.2	1.6	1.0	1.5	0.3 min.
GRM31A7U2J120JW31D	DC630	U2J (EIA)	12 ±5%	3.2	1.6	1.0	1.5	0.3 min.
GRM31A7U2J150JW31D	DC630	U2J (EIA)	15 ±5%	3.2	1.6	1.0	1.5	0.3 min.
GRM31A7U2J180JW31D	DC630	U2J (EIA)	18 ±5%	3.2	1.6	1.0	1.5	0.3 min.
GRM31A7U2J220JW31D	DC630	U2J (EIA)	22 ±5%	3.2	1.6	1.0	1.5	0.3 min.
GRM31A7U2J270JW31D	DC630	U2J (EIA)	27 ±5%	3.2	1.6	1.0	1.5	0.3 min.
GRM31A7U2J330JW31D	DC630	U2J (EIA)	33 ±5%	3.2	1.6	1.0	1.5	0.3 min.
GRM31A7U2J390JW31D	DC630	U2J (EIA)	39 ±5%	3.2	1.6	1.0	1.5	0.3 min.
GRM31A7U2J470JW31D	DC630	U2J (EIA)	47 ±5%	3.2	1.6	1.0	1.5	0.3 min.
GRM31A7U2J560JW31D	DC630	U2J (EIA)	56 ±5%	3.2	1.6	1.0	1.5	0.3 min.
GRM31A7U2J680JW31D	DC630	U2J (EIA)	68 ±5%	3.2	1.6	1.0	1.5	0.3 min.
GRM31A7U2J820JW31D	DC630	U2J (EIA)	82 ±5%	3.2	1.6	1.0	1.5	0.3 min.
GRM31A7U2J101JW31D	DC630	U2J (EIA)	100 ±5%	3.2	1.6	1.0	1.5	0.3 min.
GRM31A7U2J121JW31D	DC630	U2J (EIA)	120 ±5%	3.2	1.6	1.0	1.5	0.3 min.
GRM31A7U2J151JW31D	DC630	U2J (EIA)	150 ±5%	3.2	1.6	1.0	1.5	0.3 min.
GRM31A7U2J181JW31D	DC630	U2J (EIA)	180 ±5%	3.2	1.6	1.0	1.5	0.3 min.
GRM31A7U2J221JW31D	DC630	U2J (EIA)	220 ±5%	3.2	1.6	1.0	1.5	0.3 min.
GRM31A7U2J271JW31D	DC630	U2J (EIA)	270 ±5%	3.2	1.6	1.0	1.5	0.3 min.
GRM31A7U2J331JW31D	DC630	U2J (EIA)	330 ±5%	3.2	1.6	1.0	1.5	0.3 min.
GRM31A7U2J391JW31D	DC630	U2J (EIA)	390 ±5%	3.2	1.6	1.0	1.5	0.3 min.
GRM31A7U2J471JW31D	DC630	U2J (EIA)	470 ±5%	3.2	1.6	1.0	1.5	0.3 min.
GRM31A7U2J561JW31D	DC630	U2J (EIA)	560 ±5%	3.2	1.6	1.0	1.5	0.3 min.
GRM31A7U2J681JW31D	DC630	U2J (EIA)	680 ±5%	3.2	1.6	1.0	1.5	0.3 min.
GRM31A7U2J821JW31D	DC630	U2J (EIA)	820 ±5%	3.2	1.6	1.0	1.5	0.3 min.
GRM31A7U2J102JW31D	DC630	U2J (EIA)	1000 ±5%	3.2	1.6	1.0	1.5	0.3 min.
GRM32A7U2J122JW31D	DC630	U2J (EIA)	1200 ±5%	3.2	2.5	1.0	1.5	0.3 min.
GRM32A7U2J152JW31D	DC630	U2J (EIA)	1500 ±5%	3.2	2.5	1.0	1.5	0.3 min.
GRM32A7U2J182JW31D	DC630	U2J (EIA)	1800 ±5%	3.2	2.5	1.0	1.5	0.3 min.
GRM32A7U2J222JW31D	DC630	U2J (EIA)	2200 ±5%	3.2	2.5	1.0	1.5	0.3 min.

Continued on the following page. 

Continued from the preceding page.

Part Number	Rated Voltage (V)	TC Code (Standard)	Capacitance (pF)	Length L (mm)	Width W (mm)	Thickness T (mm)	Electrode g min. (mm)	Electrode e (mm)
GRM31A7U3A100JW31D	DC1000	U2J (EIA)	10 ±5%	3.2	1.6	1.0	1.5	0.3 min.
GRM31A7U3A120JW31D	DC1000	U2J (EIA)	12 ±5%	3.2	1.6	1.0	1.5	0.3 min.
GRM31A7U3A150JW31D	DC1000	U2J (EIA)	15 ±5%	3.2	1.6	1.0	1.5	0.3 min.
GRM31A7U3A180JW31D	DC1000	U2J (EIA)	18 ±5%	3.2	1.6	1.0	1.5	0.3 min.
GRM31A7U3A220JW31D	DC1000	U2J (EIA)	22 ±5%	3.2	1.6	1.0	1.5	0.3 min.
GRM31A7U3A270JW31D	DC1000	U2J (EIA)	27 ±5%	3.2	1.6	1.0	1.5	0.3 min.
GRM31A7U3A330JW31D	DC1000	U2J (EIA)	33 ±5%	3.2	1.6	1.0	1.5	0.3 min.
GRM31A7U3A390JW31D	DC1000	U2J (EIA)	39 ±5%	3.2	1.6	1.0	1.5	0.3 min.
GRM31A7U3A470JW31D	DC1000	U2J (EIA)	47 ±5%	3.2	1.6	1.0	1.5	0.3 min.
GRM31A7U3A560JW31D	DC1000	U2J (EIA)	56 ±5%	3.2	1.6	1.0	1.5	0.3 min.
GRM31A7U3A680JW31D	DC1000	U2J (EIA)	68 ±5%	3.2	1.6	1.0	1.5	0.3 min.
GRM31A7U3A820JW31D	DC1000	U2J (EIA)	82 ±5%	3.2	1.6	1.0	1.5	0.3 min.
GRM31A7U3A101JW31D	DC1000	U2J (EIA)	100 ±5%	3.2	1.6	1.0	1.5	0.3 min.
GRM31A7U3A121JW31D	DC1000	U2J (EIA)	120 ±5%	3.2	1.6	1.0	1.5	0.3 min.
GRM31A7U3A151JW31D	DC1000	U2J (EIA)	150 ±5%	3.2	1.6	1.0	1.5	0.3 min.
GRM31A7U3A181JW31D	DC1000	U2J (EIA)	180 ±5%	3.2	1.6	1.0	1.5	0.3 min.
GRM31A7U3A221JW31D	DC1000	U2J (EIA)	220 ±5%	3.2	1.6	1.0	1.5	0.3 min.
GRM31A7U3A271JW31D	DC1000	U2J (EIA)	270 ±5%	3.2	1.6	1.0	1.5	0.3 min.
GRM31A7U3A331JW31D	DC1000	U2J (EIA)	330 ±5%	3.2	1.6	1.0	1.5	0.3 min.
GRM31B7U3A391JW31L	DC1000	U2J (EIA)	390 ±5%	3.2	1.6	1.25	1.5	0.3 min.
GRM31B7U3A471JW31L	DC1000	U2J (EIA)	470 ±5%	3.2	1.6	1.25	1.5	0.3 min.
GRM31A7U3D100JW31D	DC2000	U2J (EIA)	10 ±5%	3.2	1.6	1.0	1.8	0.3 min.
GRM31A7U3D120JW31D	DC2000	U2J (EIA)	12 ±5%	3.2	1.6	1.0	1.8	0.3 min.
GRM31A7U3D150JW31D	DC2000	U2J (EIA)	15 ±5%	3.2	1.6	1.0	1.8	0.3 min.
GRM31A7U3D180JW31D	DC2000	U2J (EIA)	18 ±5%	3.2	1.6	1.0	1.8	0.3 min.
GRM31A7U3D220JW31D	DC2000	U2J (EIA)	22 ±5%	3.2	1.6	1.0	1.8	0.3 min.
GRM31A7U3D270JW31D	DC2000	U2J (EIA)	27 ±5%	3.2	1.6	1.0	1.8	0.3 min.
GRM31A7U3D330JW31D	DC2000	U2J (EIA)	33 ±5%	3.2	1.6	1.0	1.8	0.3 min.
GRM31A7U3D390JW31D	DC2000	U2J (EIA)	39 ±5%	3.2	1.6	1.0	1.8	0.3 min.
GRM31A7U3D470JW31D	DC2000	U2J (EIA)	47 ±5%	3.2	1.6	1.0	1.8	0.3 min.
GRM31A7U3D560JW31D	DC2000	U2J (EIA)	56 ±5%	3.2	1.6	1.0	1.8	0.3 min.
GRM31A7U3D680JW31D	DC2000	U2J (EIA)	68 ±5%	3.2	1.6	1.0	1.8	0.3 min.
GRM32A7U3D820JW31D	DC2000	U2J (EIA)	82 ±5%	3.2	2.5	1.0	1.8	0.3 min.
GRM32A7U3D101JW31D	DC2000	U2J (EIA)	100 ±5%	3.2	2.5	1.0	1.8	0.3 min.
GRM32A7U3D121JW31D	DC2000	U2J (EIA)	120 ±5%	3.2	2.5	1.0	1.8	0.3 min.
GRM32A7U3D151JW31D	DC2000	U2J (EIA)	150 ±5%	3.2	2.5	1.0	1.8	0.3 min.
GRM32B7U3D181JW31L	DC2000	U2J (EIA)	180 ±5%	3.2	2.5	1.25	1.8	0.3 min.
GRM32B7U3D221JW31L	DC2000	U2J (EIA)	220 ±5%	3.2	2.5	1.25	1.8	0.3 min.
GRM42A7U3F270JW31L	DC3150	U2J (EIA)	27 ±5%	4.5	2.0	1.0	2.9	0.3 min.
GRM42A7U3F330JW31L	DC3150	U2J (EIA)	33 ±5%	4.5	2.0	1.0	2.9	0.3 min.
GRM42A7U3F390JW31L	DC3150	U2J (EIA)	39 ±5%	4.5	2.0	1.0	2.9	0.3 min.
GRM42A7U3F470JW31L	DC3150	U2J (EIA)	47 ±5%	4.5	2.0	1.0	2.9	0.3 min.
GRM42A7U3F560JW31L	DC3150	U2J (EIA)	56 ±5%	4.5	2.0	1.0	2.9	0.3 min.
GRM42A7U3F680JW31L	DC3150	U2J (EIA)	68 ±5%	4.5	2.0	1.0	2.9	0.3 min.
GRM42A7U3F820JW31L	DC3150	U2J (EIA)	82 ±5%	4.5	2.0	1.0	2.9	0.3 min.
GRM42A7U3F101JW31L	DC3150	U2J (EIA)	100 ±5%	4.5	2.0	1.0	2.9	0.3 min.

Specifications and Test Methods

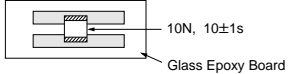
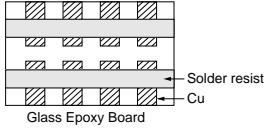
No.	Item	Specifications	Test Method												
1	Operating Temperature Range	-55 to +125°C	—												
2	Appearance	No defects or abnormalities	Visual inspection												
3	Dimensions	Within the specified dimension	Using calipers												
4	Dielectric Strength	No defects or abnormalities	<p>No failure should be observed when voltage in Table is applied between the terminations for 1 to 5 sec., provided the charge/discharge current is less than 50mA.</p> <table border="1"> <thead> <tr> <th>Rated Voltage</th> <th>Test Voltage</th> </tr> </thead> <tbody> <tr> <td>DC250V</td> <td>200% of the rated voltage</td> </tr> <tr> <td>DC630V</td> <td>150% of the rated voltage</td> </tr> <tr> <td>DC1kV, DC2kV</td> <td>120% of the rated voltage</td> </tr> <tr> <td>DC3.15kV</td> <td>DC4095V</td> </tr> </tbody> </table>	Rated Voltage	Test Voltage	DC250V	200% of the rated voltage	DC630V	150% of the rated voltage	DC1kV, DC2kV	120% of the rated voltage	DC3.15kV	DC4095V		
Rated Voltage	Test Voltage														
DC250V	200% of the rated voltage														
DC630V	150% of the rated voltage														
DC1kV, DC2kV	120% of the rated voltage														
DC3.15kV	DC4095V														
5	Insulation Resistance (I.R.)	More than 10,000MΩ	The insulation resistance should be measured with DC500±50V (DC250±25V in case of rated voltage: DC250V) and within 60±5 sec. of charging.												
6	Capacitance	Within the specified tolerance	The capacitance/Q should be measured at the frequency and voltage shown as follows.												
7	Q	1,000 min.	<table border="1"> <thead> <tr> <th>Capacitance</th> <th>Frequency</th> <th>Voltage</th> </tr> </thead> <tbody> <tr> <td>C<1,000pF</td> <td>1±0.2MHz</td> <td>AC0.5 to 5V(r.m.s.)</td> </tr> <tr> <td>C≥1,000pF</td> <td>1±0.2kHz</td> <td>AC1±0.2V(r.m.s.)</td> </tr> </tbody> </table>	Capacitance	Frequency	Voltage	C<1,000pF	1±0.2MHz	AC0.5 to 5V(r.m.s.)	C≥1,000pF	1±0.2kHz	AC1±0.2V(r.m.s.)			
Capacitance	Frequency	Voltage													
C<1,000pF	1±0.2MHz	AC0.5 to 5V(r.m.s.)													
C≥1,000pF	1±0.2kHz	AC1±0.2V(r.m.s.)													
8	Capacitance Temperature Characteristics	Temp. Coefficient C0G char. : 0±30ppm/°C (Temp. Range : +25 to +125°C) 0+30, -72ppm/°C (Temp. Range : -55 to +25°C) U2J char. : -750±120ppm/°C (Temp. Range : +25 to +125°C) -750+120, -347ppm/°C (Temp. Range : -55 to +25°C)	The capacitance measurement should be made at each step specified in Table. <table border="1"> <thead> <tr> <th>Step</th> <th>Temperature (°C)</th> </tr> </thead> <tbody> <tr> <td>1</td> <td>25±2</td> </tr> <tr> <td>2</td> <td>Min. Operating Temp.±3</td> </tr> <tr> <td>3</td> <td>25±2</td> </tr> <tr> <td>4</td> <td>Max. Operating Temp.±2</td> </tr> <tr> <td>5</td> <td>25±2</td> </tr> </tbody> </table>	Step	Temperature (°C)	1	25±2	2	Min. Operating Temp.±3	3	25±2	4	Max. Operating Temp.±2	5	25±2
Step	Temperature (°C)														
1	25±2														
2	Min. Operating Temp.±3														
3	25±2														
4	Max. Operating Temp.±2														
5	25±2														
9	Adhesive Strength of Termination	No removal of the terminations or other defect should occur.	Solder the capacitor to the testing jig (glass epoxy board) shown in Fig. 1. Then apply 10N force in the direction of the arrow. The soldering should be done using the reflow method and should be conducted with care so that the soldering is uniform and free of defects such as heat shock. <div style="text-align: center;">  <p>10N, 10±1s Glass Epoxy Board</p> </div> <p>Fig. 1</p>												
10	Appearance	No defects or abnormalities	Solder the capacitor to the test jig (glass epoxy board). The capacitor should be subjected to a simple harmonic motion having a total amplitude of 1.5mm, the frequency being varied uniformly between the approximate limits of 10 and 55Hz. The frequency range, from 10 to 55Hz and return to 10Hz, should be traversed in approximately 1 min. This motion should be applied for a period of 2 hrs. in each of 3 mutually perpendicular directions (total of 6 hrs.). <div style="text-align: center;">  <p>Solder resist Cu Glass Epoxy Board</p> </div>												
	Capacitance	Within the specified tolerance													
	Q	1,000 min.													

9

Continued on the following page.

Specifications and Test Methods

Continued from the preceding page.

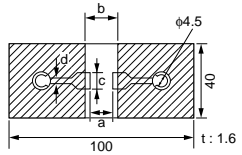
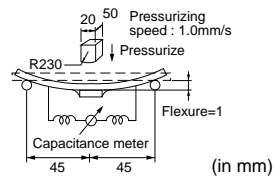
No.	Item	Specifications	Test Method																						
11	Deflection	No cracking or marking defects should occur.	Solder the capacitor to the testing jig (glass epoxy board) shown in Fig. 2. Then apply a force in the direction shown in Fig. 3. The soldering should be done using the reflow method and should be conducted with care so that the soldering is uniform and free of defects such as heat shock.																						
		 <table border="1" data-bbox="414 472 889 609"> <thead> <tr> <th rowspan="2">L×W (mm)</th> <th colspan="3">Dimension (mm)</th> <th rowspan="2">d</th> </tr> <tr> <th>a</th> <th>b</th> <th>c</th> </tr> </thead> <tbody> <tr> <td>2.0×1.25</td> <td>1.2</td> <td>4.0</td> <td>1.65</td> <td rowspan="4">1.0</td> </tr> <tr> <td>3.2×1.6</td> <td>2.2</td> <td>5.0</td> <td>2.0</td> </tr> <tr> <td>3.2×2.5</td> <td>2.2</td> <td>5.0</td> <td>2.9</td> </tr> <tr> <td>4.5×2.0</td> <td>3.5</td> <td>7.0</td> <td>2.4</td> </tr> </tbody> </table> <p style="text-align: center;">Fig. 2</p>		L×W (mm)	Dimension (mm)			d	a	b	c	2.0×1.25	1.2	4.0	1.65	1.0	3.2×1.6	2.2	5.0	2.0	3.2×2.5	2.2	5.0	2.9	4.5×2.0
L×W (mm)	Dimension (mm)				d																				
	a	b	c																						
2.0×1.25	1.2	4.0	1.65	1.0																					
3.2×1.6	2.2	5.0	2.0																						
3.2×2.5	2.2	5.0	2.9																						
4.5×2.0	3.5	7.0	2.4																						
			 <p style="text-align: center;">Fig. 3</p>																						
12	Solderability of Termination	75% of the terminations are to be soldered evenly and continuously.	Immerse the capacitor in a solution of ethanol (JIS-K-8101) and rosin (JIS-K-5902) (25% rosin in weight proportion). Immerse in solder solution for 2±0.5 sec. Immersing speed: 25±2.5mm/s Temp. of solder: 245±5°C Lead Free Solder (Sn-3.0Ag-0.5Cu) 235±5°C H60A or H63A Eutectic Solder																						
13	Resistance to Soldering Heat	Appearance	No marking defects	Preheat the capacitor at 120 to 150°C* for 1 min. Immerse the capacitor in solder solution at 260±5°C for 10±1 sec. Let sit at room condition* for 24±2 hrs., then measure. •Immersing speed: 25±2.5mm/s *Preheating for more than 3.2×2.5mm																					
		Capacitance Change	Within ±2.5%																						
		Q	1,000 min.																						
		I.R.	More than 10,000MΩ																						
		Dielectric Strength	In accordance with item No.4																						
14	Temperature Cycle	Appearance	No marking defects	Fix the capacitor to the supporting jig (glass epoxy board) shown in Fig. 4. Perform the 5 cycles according to the 4 heat treatments listed in the following table. Let sit for 24±2 hrs. at room condition*, then measure.																					
		Capacitance Change	Within ±2.5%																						
		Q	500 min.																						
		I.R.	More than 10,000MΩ																						
		Dielectric Strength	In accordance with item No.4																						
15	Humidity (Steady State)	Appearance	No marking defects	Let the capacitor sit at 40±2°C and relative humidity of 90 to 95% for 500±2 hrs. Remove and let sit for 24±2 hrs. at room condition*, then measure.																					
		Capacitance Change	Within ±5.0%																						
		Q	350 min.																						
		I.R.	More than 1,000MΩ																						
		Dielectric Strength	In accordance with item No.4																						
16	Life	Appearance	No marking defects	Apply voltage as Table for 1,000±4 hrs. at maximum operating temperature ±3°C. Remove and let sit for 24±2 hrs. at room condition*, then measure.																					
		Capacitance Change	Within ±3.0%																						
		Q	350 min.																						
		I.R.	More than 1,000MΩ																						
		Dielectric Strength	In accordance with item No.4																						

Step	Temperature	Time
1	100 to 120°C	1 min.
2	170 to 200°C	1 min.

Step	Temperature (°C)	Time (min.)
1	Min. Operating Temp.±3	30±3
2	Room Temp.	2 to 3
3	Max. Operating Temp.±2	30±3
4	Room Temp.	2 to 3

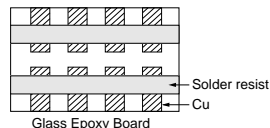

Rated Voltage	Applied Voltage
DC250V	150% of the rated voltage
DC630V, DC1kV, DC2kV, DC3.15kV	120% of the rated voltage

* "Room condition" Temperature: 15 to 35°C, Relative humidity: 45 to 75%, Atmospheric pressure: 86 to 106kPa

Chip Monolithic Ceramic Capacitors



Medium Voltage High Capacitance for General Use

■ Features

1. A new monolithic structure for small, high capacitance capable of operating at high voltage levels.
2. Sn-plated external electrodes realizes good solderability.
3. Use the GRM18/21/31 types with flow or reflow soldering, and other types with reflow soldering only.

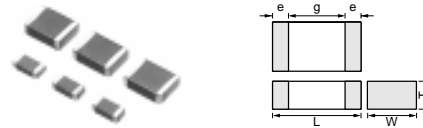

Part Number	Dimensions (mm)					
	L	W	T	e	g min.	
GRM188	1.6 ±0.1	0.8 ±0.1	0.8 ±0.1	0.2 to 0.5	0.4	
GRM21A	2.0 ±0.2	1.25 ±0.2	1.0 +0,-0.3			
GRM21B			1.25 ±0.2	0.7		
GRM31B	3.2 ±0.2	1.6 ±0.2	1.25 +0,-0.3		0.3 min.	1.2
GRM31C			1.6 ±0.2			
GRM32Q	3.2 ±0.3	2.5 ±0.2	1.5 +0,-0.3			
GRM32D			2.0 +0,-0.3			
GRM43Q	4.5 ±0.4	3.2 ±0.3	1.5 +0,-0.3	2.2		
GRM43D			2.0 +0,-0.3			
GRM55D	5.7 ±0.4	5.0 ±0.4	2.0 +0,-0.3	3.2		

■ Applications

1. Ideal for use on diode-snubber circuits for switching power supplies.
2. Ideal for use as primary-secondary coupling for DC-DC converter.
3. Ideal for use on line filters and ringer detectors for telephones, facsimiles and modems.

Do not use these products in any Automotive Power train or Safety equipment including Battery charger for Electric Vehicles and Plug-in Hybrid. Only Murata products clearly stipulated as "for Automotive use" on its catalog can be used for automobile applications such as Power train and Safety equipment.

Part Number	Rated Voltage (V)	TC Code (Standard)	Capacitance	Length L (mm)	Width W (mm)	Thickness T (mm)	Electrode g min. (mm)	Electrode e (mm)
GRM188R72E221KW07D	DC250	X7R (EIA)	220pF ±10%	1.6	0.8	0.8	0.4	0.2 to 0.5
GRM188R72E331KW07D	DC250	X7R (EIA)	330pF ±10%	1.6	0.8	0.8	0.4	0.2 to 0.5
GRM188R72E471KW07D	DC250	X7R (EIA)	470pF ±10%	1.6	0.8	0.8	0.4	0.2 to 0.5
GRM188R72E681KW07D	DC250	X7R (EIA)	680pF ±10%	1.6	0.8	0.8	0.4	0.2 to 0.5
GRM188R72E102KW07D	DC250	X7R (EIA)	1000pF ±10%	1.6	0.8	0.8	0.4	0.2 to 0.5
GRM21AR72E102KW01D	DC250	X7R (EIA)	1000pF ±10%	2.0	1.25	1.0	0.7	0.3 min.
GRM188R72E152KW07D	DC250	X7R (EIA)	1500pF ±10%	1.6	0.8	0.8	0.4	0.2 to 0.5
GRM21AR72E152KW01D	DC250	X7R (EIA)	1500pF ±10%	2.0	1.25	1.0	0.7	0.3 min.
GRM188R72E222KW07D	DC250	X7R (EIA)	2200pF ±10%	1.6	0.8	0.8	0.4	0.2 to 0.5
GRM21AR72E222KW01D	DC250	X7R (EIA)	2200pF ±10%	2.0	1.25	1.0	0.7	0.3 min.
GRM21AR72E332KW01D	DC250	X7R (EIA)	3300pF ±10%	2.0	1.25	1.0	0.7	0.3 min.
GRM21AR72E472KW01D	DC250	X7R (EIA)	4700pF ±10%	2.0	1.25	1.0	0.7	0.3 min.
GRM21AR72E682KW01D	DC250	X7R (EIA)	6800pF ±10%	2.0	1.25	1.0	0.7	0.3 min.
GRM21BR72E103KW03L	DC250	X7R (EIA)	10000pF ±10%	2.0	1.25	1.25	0.7	0.3 min.
GRM31BR72E153KW01L	DC250	X7R (EIA)	15000pF ±10%	3.2	1.6	1.25	1.2	0.3 min.
GRM31BR72E223KW01L	DC250	X7R (EIA)	22000pF ±10%	3.2	1.6	1.25	1.2	0.3 min.
GRM31CR72E333KW03L	DC250	X7R (EIA)	33000pF ±10%	3.2	1.6	1.6	1.2	0.3 min.
GRM31CR72E473KW03L	DC250	X7R (EIA)	47000pF ±10%	3.2	1.6	1.6	1.2	0.3 min.
GRM31BR72E683KW01L	DC250	X7R (EIA)	68000pF ±10%	3.2	1.6	1.25	1.2	0.3 min.
GRM32QR72E683KW01L	DC250	X7R (EIA)	68000pF ±10%	3.2	2.5	1.5	1.2	0.3 min.
GRM31CR72E104KW03L	DC250	X7R (EIA)	0.10µF ±10%	3.2	1.6	1.6	1.2	0.3 min.
GRM32DR72E104KW01L	DC250	X7R (EIA)	0.10µF ±10%	3.2	2.5	2.0	1.2	0.3 min.
GRM32QR72E154KW01L	DC250	X7R (EIA)	0.15µF ±10%	3.2	2.5	1.5	1.2	0.3 min.
GRM43QR72E154KW01L	DC250	X7R (EIA)	0.15µF ±10%	4.5	3.2	1.5	2.2	0.3 min.

Continued on the following page.

Continued from the preceding page.

Part Number	Rated Voltage (V)	TC Code (Standard)	Capacitance	Length L (mm)	Width W (mm)	Thickness T (mm)	Electrode g min. (mm)	Electrode e (mm)
GRM32DR72E224KW01L	DC250	X7R (EIA)	0.22μF ±10%	3.2	2.5	2.0	1.2	0.3 min.
GRM43DR72E224KW01L	DC250	X7R (EIA)	0.22μF ±10%	4.5	3.2	2.0	2.2	0.3 min.
GRM43DR72E334KW01L	DC250	X7R (EIA)	0.33μF ±10%	4.5	3.2	2.0	2.2	0.3 min.
GRM55DR72E334KW01L	DC250	X7R (EIA)	0.33μF ±10%	5.7	5.0	2.0	3.2	0.3 min.
GRM43DR72E474KW01L	DC250	X7R (EIA)	0.47μF ±10%	4.5	3.2	2.0	2.2	0.3 min.
GRM55DR72E474KW01L	DC250	X7R (EIA)	0.47μF ±10%	5.7	5.0	2.0	3.2	0.3 min.
GRM55DR72E105KW01L	DC250	X7R (EIA)	1.0μF ±10%	5.7	5.0	2.0	3.2	0.3 min.
GRM31BR72J102KW01L	DC630	X7R (EIA)	1000pF ±10%	3.2	1.6	1.25	1.2	0.3 min.
GRM31BR72J152KW01L	DC630	X7R (EIA)	1500pF ±10%	3.2	1.6	1.25	1.2	0.3 min.
GRM31BR72J222KW01L	DC630	X7R (EIA)	2200pF ±10%	3.2	1.6	1.25	1.2	0.3 min.
GRM31BR72J332KW01L	DC630	X7R (EIA)	3300pF ±10%	3.2	1.6	1.25	1.2	0.3 min.
GRM31BR72J472KW01L	DC630	X7R (EIA)	4700pF ±10%	3.2	1.6	1.25	1.2	0.3 min.
GRM31BR72J682KW01L	DC630	X7R (EIA)	6800pF ±10%	3.2	1.6	1.25	1.2	0.3 min.
GRM31BR72J103KW01L	DC630	X7R (EIA)	10000pF ±10%	3.2	1.6	1.25	1.2	0.3 min.
GRM31CR72J153KW03L	DC630	X7R (EIA)	15000pF ±10%	3.2	1.6	1.6	1.2	0.3 min.
GRM32QR72J223KW01L	DC630	X7R (EIA)	22000pF ±10%	3.2	2.5	1.5	1.2	0.3 min.
GRM32DR72J333KW01L	DC630	X7R (EIA)	33000pF ±10%	3.2	2.5	2.0	1.2	0.3 min.
GRM32DR72J473KW01L	DC630	X7R (EIA)	47000pF ±10%	3.2	2.5	2.0	1.2	0.3 min.
GRM43QR72J683KW01L	DC630	X7R (EIA)	68000pF ±10%	4.5	3.2	1.5	2.2	0.3 min.
GRM43DR72J104KW01L	DC630	X7R (EIA)	0.10μF ±10%	4.5	3.2	2.0	2.2	0.3 min.
GRM55DR72J154KW01L	DC630	X7R (EIA)	0.15μF ±10%	5.7	5.0	2.0	3.2	0.3 min.
GRM55DR72J224KW01L	DC630	X7R (EIA)	0.22μF ±10%	5.7	5.0	2.0	3.2	0.3 min.
GRM31BR73A471KW01L	DC1000	X7R (EIA)	470pF ±10%	3.2	1.6	1.25	1.2	0.3 min.
GRM31BR73A102KW01L	DC1000	X7R (EIA)	1000pF ±10%	3.2	1.6	1.25	1.2	0.3 min.
GRM31BR73A152KW01L	DC1000	X7R (EIA)	1500pF ±10%	3.2	1.6	1.25	1.2	0.3 min.
GRM31BR73A222KW01L	DC1000	X7R (EIA)	2200pF ±10%	3.2	1.6	1.25	1.2	0.3 min.
GRM31BR73A332KW01L	DC1000	X7R (EIA)	3300pF ±10%	3.2	1.6	1.25	1.2	0.3 min.
GRM31BR73A472KW01L	DC1000	X7R (EIA)	4700pF ±10%	3.2	1.6	1.25	1.2	0.3 min.
GRM32QR73A682KW01L	DC1000	X7R (EIA)	6800pF ±10%	3.2	2.5	1.5	1.2	0.3 min.
GRM32QR73A103KW01L	DC1000	X7R (EIA)	10000pF ±10%	3.2	2.5	1.5	1.2	0.3 min.
GRM32DR73A153KW01L	DC1000	X7R (EIA)	15000pF ±10%	3.2	2.5	2.0	1.2	0.3 min.
GRM32DR73A223KW01L	DC1000	X7R (EIA)	22000pF ±10%	3.2	2.5	2.0	1.2	0.3 min.
GRM43DR73A333KW01L	DC1000	X7R (EIA)	33000pF ±10%	4.5	3.2	2.0	2.2	0.3 min.
GRM43DR73A473KW01L	DC1000	X7R (EIA)	47000pF ±10%	4.5	3.2	2.0	2.2	0.3 min.
GRM55DR73A104KW01L	DC1000	X7R (EIA)	0.10μF ±10%	5.7	5.0	2.0	3.2	0.3 min.

Specifications and Test Methods

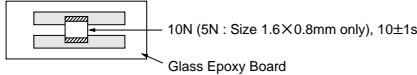
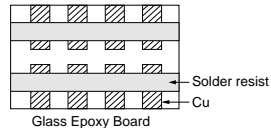
No.	Item	Specifications	Test Method												
1	Operating Temperature Range	-55 to +125°C	—												
2	Appearance	No defects or abnormalities	Visual inspection												
3	Dimensions	Within the specified dimensions	Using calipers												
4	Dielectric Strength	No defects or abnormalities	No failure should be observed when 150% of the rated voltage (200% of the rated voltage in case of rated voltage: DC250V, 120% of the rated voltage in case of rated voltage: DC1kV) is applied between the terminations for 1 to 5 sec., provided the charge/discharge current is less than 50mA.												
5	Insulation Resistance (I.R.)	$C \geq 0.01\mu\text{F}$: More than $100\text{M}\Omega \cdot \mu\text{F}$ $C < 0.01\mu\text{F}$: More than $10,000\text{M}\Omega$	The insulation resistance should be measured with $\text{DC}500 \pm 50\text{V}$ ($\text{DC}250 \pm 25\text{V}$ in case of rated voltage: DC250V) and within 60 ± 5 sec. of charging.												
6	Capacitance	Within the specified tolerance	The capacitance/D.F. should be measured at a frequency of $1 \pm 0.2\text{kHz}$ and a voltage of $\text{AC}1 \pm 0.2\text{V}$ (r.m.s.)												
7	Dissipation Factor (D.F.)	0.025 max.													
8	Capacitance Temperature Characteristics	Cap. Change Within $\pm 15\%$ (Temp. Range: -55 to +125°C)	<p>The capacitance measurement should be made at each step specified in Table.</p> <table border="1" style="margin-left: auto; margin-right: auto;"> <thead> <tr> <th>Step</th> <th>Temperature (°C)</th> </tr> </thead> <tbody> <tr> <td>1</td> <td>25 ± 2</td> </tr> <tr> <td>2</td> <td>Min. Operating Temp. ± 3</td> </tr> <tr> <td>3</td> <td>25 ± 2</td> </tr> <tr> <td>4</td> <td>Max. Operating Temp. ± 2</td> </tr> <tr> <td>5</td> <td>25 ± 2</td> </tr> </tbody> </table> <p>•Pretreatment Perform a heat treatment at $150 \pm 9.0^\circ\text{C}$ for 60 ± 5 min. and then let sit for 24 ± 2 hrs. at room condition*.</p>	Step	Temperature (°C)	1	25 ± 2	2	Min. Operating Temp. ± 3	3	25 ± 2	4	Max. Operating Temp. ± 2	5	25 ± 2
Step	Temperature (°C)														
1	25 ± 2														
2	Min. Operating Temp. ± 3														
3	25 ± 2														
4	Max. Operating Temp. ± 2														
5	25 ± 2														
9	Adhesive Strength of Termination	No removal of the terminations or other defect should occur.	<p>Solder the capacitor to the testing jig (glass epoxy board) shown in Fig. 1. Then apply 10N force in the direction of the arrow. The soldering should be done using the reflow method and should be conducted with care so that the soldering is uniform and free of defects such as heat shock.</p> <div style="text-align: center;">  <p>10N (5N : Size 1.6×0.8mm only), $10 \pm 1\text{s}$ Glass Epoxy Board</p> </div> <p>Fig. 1</p>												
10	Vibration Resistance	Appearance	No defects or abnormalities												
		Capacitance	Within the specified tolerance												
		D.F.	0.025 max.												
			<p>Solder the capacitor to the test jig (glass epoxy board). The capacitor should be subjected to a simple harmonic motion having a total amplitude of 1.5mm, the frequency being varied uniformly between the approximate limits of 10 and 55Hz. The frequency range, from 10 to 55Hz and return to 10Hz, should be traversed in approximately 1 min. This motion should be applied for a period of 2 hrs. in each of 3 mutually perpendicular directions (total of 6 hrs.).</p> <div style="text-align: center;">  <p>Solder resist Cu Glass Epoxy Board</p> </div>												

* "Room condition" Temperature: 15 to 35°C, Relative humidity: 45 to 75%, Atmospheric pressure: 86 to 106kPa

Continued on the following page.

10

Specifications and Test Methods

Continued from the preceding page.

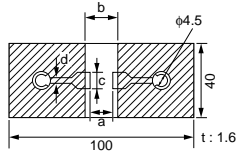
No.	Item	Specifications	Test Method																																
11	Deflection	No cracking or marking defects should occur.	Solder the capacitor to the testing jig (glass epoxy board) shown in Fig. 2. Then apply a force in the direction shown in Fig. 3. The soldering should be done using the reflow method and should be conducted with care so that the soldering is uniform and free of defects such as heat shock.																																
		 <table border="1" data-bbox="414 478 889 661"> <thead> <tr> <th>L×W (mm)</th> <th colspan="4">Dimension (mm)</th> </tr> <tr> <th></th> <th>a</th> <th>b</th> <th>c</th> <th>d</th> </tr> </thead> <tbody> <tr> <td>1.6×0.8</td> <td>1.0</td> <td>3.0</td> <td>1.2</td> <td rowspan="6">1.0</td> </tr> <tr> <td>2.0×1.25</td> <td>1.2</td> <td>4.0</td> <td>1.65</td> </tr> <tr> <td>3.2×1.6</td> <td>2.2</td> <td>5.0</td> <td>2.0</td> </tr> <tr> <td>3.2×2.5</td> <td>2.2</td> <td>5.0</td> <td>2.9</td> </tr> <tr> <td>4.5×3.2</td> <td>3.5</td> <td>7.0</td> <td>3.7</td> </tr> <tr> <td>5.7×5.0</td> <td>4.5</td> <td>8.0</td> <td>5.6</td> </tr> </tbody> </table> <p>Fig. 2</p>		L×W (mm)	Dimension (mm)					a	b	c	d	1.6×0.8	1.0	3.0	1.2	1.0	2.0×1.25	1.2	4.0	1.65	3.2×1.6	2.2	5.0	2.0	3.2×2.5	2.2	5.0	2.9	4.5×3.2	3.5	7.0	3.7	5.7×5.0
L×W (mm)	Dimension (mm)																																		
	a	b	c	d																															
1.6×0.8	1.0	3.0	1.2	1.0																															
2.0×1.25	1.2	4.0	1.65																																
3.2×1.6	2.2	5.0	2.0																																
3.2×2.5	2.2	5.0	2.9																																
4.5×3.2	3.5	7.0	3.7																																
5.7×5.0	4.5	8.0	5.6																																
12	Solderability of Termination	75% of the terminations are to be soldered evenly and continuously.	Immerse the capacitor in a solution of ethanol (JIS-K-8101) and rosin (JIS-K-5902) (25% rosin in weight proportion). Immerse in solder solution for 2±0.5 sec. Immersing speed: 25±2.5mm/s Temp. of solder: 245±5°C Lead Free Solder (Sn-3.0Ag-0.5Cu) 235±5°C H60A or H63A Eutectic Solder																																
13	Resistance to Soldering Heat	Appearance	No marking defects	Preheat the capacitor at 120 to 150°C* for 1 min. Immerse the capacitor in solder solution at 260±5°C for 10±1 sec. Let sit at room condition* for 24±2 hrs., then measure. •Immersing speed: 25±2.5mm/s •Pretreatment Perform a heat treatment at 150±1°C for 60±5 min. and then let sit for 24±2 hrs. at room condition*.																															
		Capacitance Change	Within ±10%																																
		D.F.	0.025 max.																																
		I.R.	C≥0.01μF: More than 100MΩ • μF C<0.01μF: More than 10,000MΩ																																
		Dielectric Strength	In accordance with item No.4																																
14	Temperature Cycle	Appearance	No marking defects	Fix the capacitor to the supporting jig (glass epoxy board) shown in Fig. 4. Perform the 5 cycles according to the 4 heat treatments listed in the following table. Let sit for 24±2 hrs. at room condition*, then measure.																															
		Capacitance Change	Within ±7.5%																																
		D.F.	0.025 max.																																
		I.R.	C≥0.01μF: More than 100MΩ • μF C<0.01μF: More than 10,000MΩ																																
		Dielectric Strength	In accordance with item No.4																																
15	Humidity (Steady State)	Appearance	No marking defects	Let the capacitor sit at 40±2°C and relative humidity of 90 to 95% for 500±24 hrs. Remove and let sit for 24±2 hrs. at room condition*, then measure. •Pretreatment Perform a heat treatment at 150±1°C for 60±5 min. and then let sit for 24±2 hrs. at room condition*.																															
		Capacitance Change	Within ±15%																																
		D.F.	0.05 max.																																
		I.R.	C≥0.01μF: More than 10MΩ • μF C<0.01μF: More than 1,000MΩ																																
		Dielectric Strength	In accordance with item No.4																																

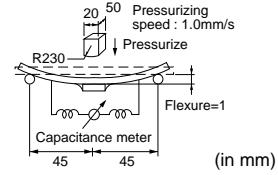

Fig. 3

Step	Temperature	Time
1	100 to 120°C	1 min.
2	170 to 200°C	1 min.

Step	Temperature (°C)	Time (min.)
1	Min. Operating Temp.±3	30±3
2	Room Temp.	2 to 3
3	Max. Operating Temp.±2	30±3
4	Room Temp.	2 to 3

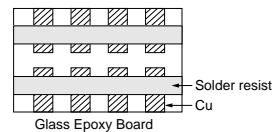

Fig. 4

* "Room condition" Temperature: 15 to 35°C, Relative humidity: 45 to 75%, Atmospheric pressure: 86 to 106kPa

Continued on the following page. ↗

Specifications and Test Methods

Continued from the preceding page.

No.	Item	Specifications	Test Method
16	Life	Appearance	No marking defects
		Capacitance Change	Within $\pm 15\%$ (rated voltage: DC250V, DC630V) Within $\pm 20\%$ (rated voltage: DC1kV)
		D.F.	0.05 max.
		I.R.	$C \geq 0.01\mu\text{F}$: More than $10\text{M}\Omega \cdot \mu\text{F}$ $C < 0.01\mu\text{F}$: More than $1,000\text{M}\Omega$
		Dielectric Strength	In accordance with item No.4
			Apply 120% of the rated voltage (150% of the rated voltage in case of rated voltage: DC250V, 110% of the rated voltage in case of rated voltage: DC1kV) for $1,000 \pm 48$ hrs. at maximum operating temperature $\pm 3^\circ\text{C}$. Remove and let sit for 24 ± 2 hrs. at room condition*, then measure. The charge/discharge current is less than 50mA. •Pretreatment Apply test voltage for 60 ± 5 min. at test temperature. Remove and let sit for 24 ± 2 hrs. at room condition*.
17	Humidity Loading (Application: DC250V, DC630V item)	Appearance	No marking defects
		Capacitance Change	Within $\pm 15\%$
		D.F.	0.05 max.
		I.R.	$C \geq 0.01\mu\text{F}$: More than $10\text{M}\Omega \cdot \mu\text{F}$ $C < 0.01\mu\text{F}$: More than $1,000\text{M}\Omega$
		Dielectric Strength	In accordance with item No.4
			Apply the rated voltage at $40 \pm 2^\circ\text{C}$ and relative humidity of 90 to 95% for 500 ± 24 hrs. Remove and let sit for 24 ± 2 hrs. at room condition*, then measure. •Pretreatment Apply test voltage for 60 ± 5 min. at test temperature. Remove and let sit for 24 ± 2 hrs. at room condition*.

* "Room condition" Temperature: 15 to 35°C , Relative humidity: 45 to 75%, Atmospheric pressure: 86 to 106kPa

Chip Monolithic Ceramic Capacitors



Only for LCD Backlight Inverter Circuit

■ Features

1. Low-loss and suitable for high frequency circuits
2. Murata's original internal electrode structure realizes high flash-over voltage.
3. A new monolithic structure for small, surface-mountable devices capable of operating at high voltage levels.
4. Sn-plated external electrodes realize good solderability.
5. Only for reflow soldering
6. The capacitors less than 22pF can be applied maximum 4.0kV peak to peak at 100kHz or less only for the ballast or the resonance usage in the LCD backlight inverter circuit.

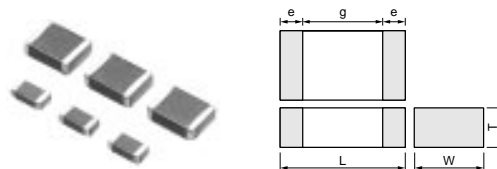

Part Number	Dimensions (mm)				
	L	W	T	e min.	g min.
GRM42A	4.5 ±0.3	2.0 ±0.2	1.0 +0, -0.3	0.3	2.9

■ Applications

Ideal for use as the ballast in LCD backlight inverter.

Do not use these products in any Automotive Power train or Safety equipment including Battery charger for Electric Vehicles and Plug-in Hybrid. Only Murata products clearly stipulated as "for Automotive use" on its catalog can be used for automobile applications such as Power train and Safety equipment.

11

Part Number	Rated Voltage (V)	TC Code (Standard)	Capacitance (pF)	Length L (mm)	Width W (mm)	Thickness T (mm)	Electrode g min. (mm)	Electrode e (mm)
GRM42A5C3F050DW01L	DC3150	C0G (EIA)	5.0 ±0.5pF	4.5	2.0	1.0	2.9	0.3 min.
GRM42A5C3F100JW01L	DC3150	C0G (EIA)	10 ±5%	4.5	2.0	1.0	2.9	0.3 min.
GRM42A5C3F120JW01L	DC3150	C0G (EIA)	12 ±5%	4.5	2.0	1.0	2.9	0.3 min.
GRM42A5C3F150JW01L	DC3150	C0G (EIA)	15 ±5%	4.5	2.0	1.0	2.9	0.3 min.
GRM42A5C3F180JW01L	DC3150	C0G (EIA)	18 ±5%	4.5	2.0	1.0	2.9	0.3 min.
GRM42A5C3F220JW01L	DC3150	C0G (EIA)	22 ±5%	4.5	2.0	1.0	2.9	0.3 min.
GRM42A5C3F270JW01L	DC3150	C0G (EIA)	27 ±5%	4.5	2.0	1.0	2.9	0.3 min.
GRM42A5C3F330JW01L	DC3150	C0G (EIA)	33 ±5%	4.5	2.0	1.0	2.9	0.3 min.
GRM42A5C3F390JW01L	DC3150	C0G (EIA)	39 ±5%	4.5	2.0	1.0	2.9	0.3 min.
GRM42A5C3F470JW01L	DC3150	C0G (EIA)	47 ±5%	4.5	2.0	1.0	2.9	0.3 min.

Specifications and Test Methods

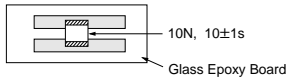
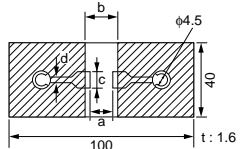
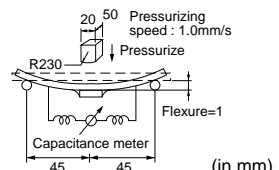
No.	Item	Specifications	Test Method														
1	Operating Temperature Range	-55 to +125°C	—														
2	Appearance	No defects or abnormalities	Visual inspection														
3	Dimensions	Within the specified dimension	Using calipers														
4	Dielectric Strength	No defects or abnormalities	No failure should be observed when DC4095V is applied between the terminations for 1 to 5 sec., provided the charge/discharge current is less than 50mA.														
5	Insulation Resistance (I.R.)	More than 10,000MΩ	The insulation resistance should be measured with DC500±50V and within 60±5 sec. of charging.														
6	Capacitance	Within the specified tolerance	The capacitance/Q should be measured at a frequency of 1±0.2MHz and a voltage of AC0.5 to 5V(r.m.s.)														
7	Q	1,000 min.															
8	Capacitance Temperature Characteristics	Temp. Coefficient 0±30ppm/°C (Temp. Range: +25 to +125°C) 0+30, -72ppm/°C (Temp. Range: -55 to +25°C)	The capacitance measurement should be made at each step specified in Table.														
			<table border="1" style="margin-left: auto; margin-right: auto;"> <thead> <tr> <th>Step</th> <th>Temperature (°C)</th> </tr> </thead> <tbody> <tr> <td>1</td> <td>25±2</td> </tr> <tr> <td>2</td> <td>Min. Operating Temp.±3</td> </tr> <tr> <td>3</td> <td>25±2</td> </tr> <tr> <td>4</td> <td>Max. Operating Temp.±2</td> </tr> <tr> <td>5</td> <td>25±2</td> </tr> </tbody> </table>	Step	Temperature (°C)	1	25±2	2	Min. Operating Temp.±3	3	25±2	4	Max. Operating Temp.±2	5	25±2		
Step	Temperature (°C)																
1	25±2																
2	Min. Operating Temp.±3																
3	25±2																
4	Max. Operating Temp.±2																
5	25±2																
9	Adhesive Strength of Termination	No removal of the terminations or other defect should occur.	<p>Solder the capacitor to the testing jig (glass epoxy board) shown in Fig. 1. Then apply 10N force in the direction of the arrow. The soldering should be done using the reflow method and should be conducted with care so that the soldering is uniform and free of defects such as heat shock.</p> <div style="text-align: center;">  <p>10N, 10±1s Glass Epoxy Board</p> </div> <p style="text-align: center;">Fig. 1</p>														
10	Vibration Resistance	Appearance	No defects or abnormalities														
		Capacitance	Within the specified tolerance														
		Q	1,000 min.														
11	Deflection	No cracking or marking defects should occur.	<p>Solder the capacitor to the testing jig (glass epoxy board) shown in Fig. 2. Then apply a force in the direction shown in Fig. 3. The soldering should be done using the reflow method and should be conducted with care so that the soldering is uniform and free of defects such as heat shock.</p> <div style="text-align: center;">  <p style="text-align: center;">t: 1.6</p> <table border="1" style="margin-left: auto; margin-right: auto;"> <thead> <tr> <th rowspan="2">L×W (mm)</th> <th colspan="4">Dimension (mm)</th> </tr> <tr> <th>a</th> <th>b</th> <th>c</th> <th>d</th> </tr> </thead> <tbody> <tr> <td>4.5×2.0</td> <td>3.5</td> <td>7.0</td> <td>2.4</td> <td>1.0</td> </tr> </tbody> </table> <p style="text-align: center;">Fig. 2</p> </div>	L×W (mm)	Dimension (mm)				a	b	c	d	4.5×2.0	3.5	7.0	2.4	1.0
		L×W (mm)			Dimension (mm)												
a	b		c	d													
4.5×2.0	3.5	7.0	2.4	1.0													
<div style="text-align: center;">  <p>20 50 Pressurizing speed : 1.0mm/s Pressurize R230 Flexure=1 Capacitance meter 45 45 (in mm)</p> </div> <p style="text-align: center;">Fig. 3</p>																	

Continued on the following page.

Specifications and Test Methods

Continued from the preceding page.

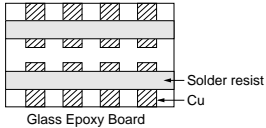
No.	Item	Specifications	Test Method															
12	Solderability of Termination	75% of the terminations are to be soldered evenly and continuously.	Immerse the capacitor in a solution of ethanol (JIS-K-8101) and rosin (JIS-K-5902) (25% rosin in weight proportion). Immerse in solder solution for 2±0.5 sec. Immersing speed: 25±2.5mm/s Temp. of solder: 245±5°C Lead Free Solder (Sn-3.0Ag-0.5Cu) 235±5°C H60A or H63A Eutectic Solder															
13	Resistance to Soldering Heat	Appearance	No marking defects															
		Capacitance Change	Within ±2.5%															
		Q	1,000 min.															
		I.R.	More than 10,000MΩ															
		Dielectric Strength	In accordance with item No.4															
			Preheat the capacitor as table. Immerse the capacitor in solder solution at 260±5°C for 10±1 sec. Let sit at room condition* for 24±2 hrs., then measure. •Immersing speed: 25±2.5mm/s *Preheating															
			<table border="1"> <thead> <tr> <th>Step</th> <th>Temperature</th> <th>Time</th> </tr> </thead> <tbody> <tr> <td>1</td> <td>100 to 120°C</td> <td>1 min.</td> </tr> <tr> <td>2</td> <td>170 to 200°C</td> <td>1 min.</td> </tr> </tbody> </table>	Step	Temperature	Time	1	100 to 120°C	1 min.	2	170 to 200°C	1 min.						
Step	Temperature	Time																
1	100 to 120°C	1 min.																
2	170 to 200°C	1 min.																
14	Temperature Cycle	Appearance	No marking defects															
		Capacitance Change	Within ±2.5%															
		Q	1,000 min.															
		I.R.	More than 10,000MΩ															
		Dielectric Strength	In accordance with item No.4															
			Fix the capacitor to the supporting jig (glass epoxy board) shown in Fig. 4. Perform the 5 cycles according to the 4 heat treatments listed in the following table. Let sit for 24±2 hrs. at room condition*, then measure.															
			<table border="1"> <thead> <tr> <th>Step</th> <th>Temperature (°C)</th> <th>Time (min.)</th> </tr> </thead> <tbody> <tr> <td>1</td> <td>Min. Operating Temp.±3</td> <td>30±3</td> </tr> <tr> <td>2</td> <td>Room Temp.</td> <td>2 to 3</td> </tr> <tr> <td>3</td> <td>Max. Operating Temp.±2</td> <td>30±3</td> </tr> <tr> <td>4</td> <td>Room Temp.</td> <td>2 to 3</td> </tr> </tbody> </table>	Step	Temperature (°C)	Time (min.)	1	Min. Operating Temp.±3	30±3	2	Room Temp.	2 to 3	3	Max. Operating Temp.±2	30±3	4	Room Temp.	2 to 3
Step	Temperature (°C)	Time (min.)																
1	Min. Operating Temp.±3	30±3																
2	Room Temp.	2 to 3																
3	Max. Operating Temp.±2	30±3																
4	Room Temp.	2 to 3																
			 <p style="text-align: center;">Fig. 4</p>															
15	Humidity (Steady State)	Appearance	No marking defects															
		Capacitance Change	Within ±5.0%															
		Q	350 min.															
		I.R.	More than 1,000MΩ															
		Dielectric Strength	In accordance with item No.4															
			Let the capacitor sit at 40±2°C and relative humidity of 90 to 95% for 500±24 hrs. Remove and let sit for 24±2 hrs. at room condition*, then measure.															
16	Life	Appearance	No marking defects															
		Capacitance Change	Within ±3.0%															
		Q	350 min.															
		I.R.	More than 1,000MΩ															
		Dielectric Strength	In accordance with item No.4															
			Apply 120% of the rated voltage for 1,000±48 hrs. at maximum operating temperature ±3°C. Remove and let sit for 24±2 hrs. at room condition*, then measure. The charge/discharge current is less than 50mA.															

* "Room condition" Temperature: 15 to 35°C, Relative humidity: 45 to 75%, Atmospheric pressure: 86 to 106kPa

Chip Monolithic Ceramic Capacitors



Only for Information Devices

■ Features

1. These items are designed specifically for telecommunications devices (IEEE802.3) in Ethernet LAN and primary-secondary coupling for DC-DC converter.
2. A new monolithic structure for small, high capacitance capable of operating at high voltage levels
3. Sn-plated external electrodes realizes good solderability.
4. Only for reflow soldering
5. The low-profile type (thickness: 1.5mm max.) is available. Fit for use on thinner type equipment.

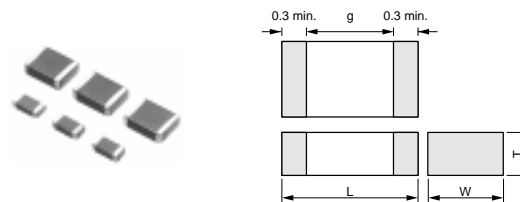

Part Number	Dimensions (mm)			
	L	W	T	g min.
GR442Q	4.5 ±0.3	2.0 ±0.2	1.5 +0, -0.3	2.5
GR443D	4.5 ±0.4	3.2 ±0.3	2.0 +0, -0.3	
GR443Q			1.5 +0, -0.3	
GR455D	5.7 ±0.4	5.0 ±0.4	2.0 +0, -0.3	3.2

■ Applications

1. Ideal for use on telecommunications devices in Ethernet LAN
2. Ideal for use as primary-secondary coupling for DC-DC converter

Do not use these products in any Automotive Power train or Safety equipment including Battery charger for Electric Vehicles and Plug-in Hybrid. Only Murata products clearly stipulated as "for Automotive use" on its catalog can be used for automobile applications such as Power train and Safety equipment.

Part Number	Rated Voltage (V)	TC Code (Standard)	Capacitance (pF)	Length L (mm)	Width W (mm)	Thickness T (mm)	Electrode g min. (mm)	Electrode e (mm)
GR442QR73D101KW01L	DC2000	X7R (EIA)	100 ±10%	4.5	2.0	1.5	2.5	0.3 min.
GR442QR73D121KW01L	DC2000	X7R (EIA)	120 ±10%	4.5	2.0	1.5	2.5	0.3 min.
GR442QR73D151KW01L	DC2000	X7R (EIA)	150 ±10%	4.5	2.0	1.5	2.5	0.3 min.
GR442QR73D181KW01L	DC2000	X7R (EIA)	180 ±10%	4.5	2.0	1.5	2.5	0.3 min.
GR442QR73D221KW01L	DC2000	X7R (EIA)	220 ±10%	4.5	2.0	1.5	2.5	0.3 min.
GR442QR73D271KW01L	DC2000	X7R (EIA)	270 ±10%	4.5	2.0	1.5	2.5	0.3 min.
GR442QR73D331KW01L	DC2000	X7R (EIA)	330 ±10%	4.5	2.0	1.5	2.5	0.3 min.
GR442QR73D391KW01L	DC2000	X7R (EIA)	390 ±10%	4.5	2.0	1.5	2.5	0.3 min.
GR442QR73D471KW01L	DC2000	X7R (EIA)	470 ±10%	4.5	2.0	1.5	2.5	0.3 min.
GR442QR73D561KW01L	DC2000	X7R (EIA)	560 ±10%	4.5	2.0	1.5	2.5	0.3 min.
GR442QR73D681KW01L	DC2000	X7R (EIA)	680 ±10%	4.5	2.0	1.5	2.5	0.3 min.
GR442QR73D821KW01L	DC2000	X7R (EIA)	820 ±10%	4.5	2.0	1.5	2.5	0.3 min.
GR442QR73D102KW01L	DC2000	X7R (EIA)	1000 ±10%	4.5	2.0	1.5	2.5	0.3 min.
GR442QR73D122KW01L	DC2000	X7R (EIA)	1200 ±10%	4.5	2.0	1.5	2.5	0.3 min.
GR442QR73D152KW01L	DC2000	X7R (EIA)	1500 ±10%	4.5	2.0	1.5	2.5	0.3 min.
GR443QR73D182KW01L	DC2000	X7R (EIA)	1800 ±10%	4.5	3.2	1.5	2.5	0.3 min.
GR443QR73D222KW01L	DC2000	X7R (EIA)	2200 ±10%	4.5	3.2	1.5	2.5	0.3 min.
GR443QR73D272KW01L	DC2000	X7R (EIA)	2700 ±10%	4.5	3.2	1.5	2.5	0.3 min.
GR443QR73D332KW01L	DC2000	X7R (EIA)	3300 ±10%	4.5	3.2	1.5	2.5	0.3 min.
GR443QR73D392KW01L	DC2000	X7R (EIA)	3900 ±10%	4.5	3.2	1.5	2.5	0.3 min.
GR443DR73D472KW01L	DC2000	X7R (EIA)	4700 ±10%	4.5	3.2	2.0	2.5	0.3 min.
GR455DR73D103KW01L	DC2000	X7R (EIA)	10000 ±10%	5.7	5.0	2.0	3.2	0.3 min.

Specifications and Test Methods

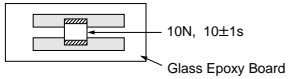
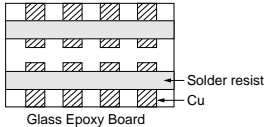
No.	Item	Specifications	Test Method												
1	Operating Temperature Range	-55 to +125°C	—												
2	Appearance	No defects or abnormalities	Visual inspection												
3	Dimensions	Within the specified dimensions	Using calipers												
4	Dielectric Strength	No defects or abnormalities	No failure should be observed when voltage in table is applied between the terminations, provided the charge/discharge current is less than 50mA. <table border="1" style="margin-left: auto; margin-right: auto; border-collapse: collapse;"> <thead> <tr style="background-color: #f2f2f2;"> <th>Rated Voltage</th> <th>Test Voltage</th> <th>Time</th> </tr> </thead> <tbody> <tr> <td rowspan="2" style="text-align: center;">DC2kV</td> <td style="text-align: center;">120% of the rated voltage</td> <td style="text-align: center;">60±1 sec.</td> </tr> <tr> <td style="text-align: center;">AC1500V(r.m.s.)</td> <td style="text-align: center;">60±1 sec.</td> </tr> </tbody> </table>	Rated Voltage	Test Voltage	Time	DC2kV	120% of the rated voltage	60±1 sec.	AC1500V(r.m.s.)	60±1 sec.				
Rated Voltage	Test Voltage	Time													
DC2kV	120% of the rated voltage	60±1 sec.													
	AC1500V(r.m.s.)	60±1 sec.													
5	Pulse Voltage	No self healing breakdowns or flash-overs have taken place in the capacitor.	10 impulse of alternating polarity is subjected. (5 impulse for each polarity) The interval between impulse is 60 sec. Applied Voltage: 2.5kV zero to peak												
6	Insulation Resistance (I.R.)	More than 6,000MΩ	The insulation resistance should be measured with DC500±50V and within 60±5 sec. of charging.												
7	Capacitance	Within the specified tolerance	The capacitance/D.F. should be measured at a frequency of 1±0.2kHz and a voltage of AC1±0.2V(r.m.s.)												
8	Dissipation Factor (D.F.)	0.025 max.													
9	Capacitance Temperature Characteristics	Cap. Change within ±15% (Temp. Range: -55 to +125°C)	The capacitance measurement should be made at each step specified in Table. <table border="1" style="margin-left: auto; margin-right: auto; border-collapse: collapse;"> <thead> <tr style="background-color: #f2f2f2;"> <th>Step</th> <th>Temperature (°C)</th> </tr> </thead> <tbody> <tr> <td style="text-align: center;">1</td> <td style="text-align: center;">25±2</td> </tr> <tr> <td style="text-align: center;">2</td> <td style="text-align: center;">Min. Operating Temp.±3</td> </tr> <tr> <td style="text-align: center;">3</td> <td style="text-align: center;">25±2</td> </tr> <tr> <td style="text-align: center;">4</td> <td style="text-align: center;">Max. Operating Temp.±2</td> </tr> <tr> <td style="text-align: center;">5</td> <td style="text-align: center;">25±2</td> </tr> </tbody> </table> <p>•Pretreatment Perform a heat treatment at 150±5°C for 60±5 min. and then let sit for 24±2 hrs. at room condition*.</p>	Step	Temperature (°C)	1	25±2	2	Min. Operating Temp.±3	3	25±2	4	Max. Operating Temp.±2	5	25±2
Step	Temperature (°C)														
1	25±2														
2	Min. Operating Temp.±3														
3	25±2														
4	Max. Operating Temp.±2														
5	25±2														
10	Adhesive Strength of Termination	No removal of the terminations or other defect should occur.	Solder the capacitor to the testing jig (glass epoxy board) shown in Fig. 1. Then apply 10N force in the direction of the arrow. The soldering should be done using the reflow method and should be conducted with care so that the soldering is uniform and free of defects such as heat shock. <div style="text-align: center; margin-top: 10px;">  <p>10N, 10±1s Glass Epoxy Board</p> </div> <p style="text-align: center;">Fig. 1</p>												
11	Vibration Resistance	Appearance	No defects or abnormalities												
		Capacitance	Within the specified tolerance												
		D.F.	0.025 max.												
			Solder the capacitor to the test jig (glass epoxy board). The capacitor should be subjected to a simple harmonic motion having a total amplitude of 1.5mm, the frequency being varied uniformly between the approximate limits of 10 and 55Hz. The frequency range, from 10 to 55Hz and return to 10Hz, should be traversed in approximately 1 min. This motion should be applied for a period of 2 hrs. in each of 3 mutually perpendicular directions (total of 6 hrs.). <div style="text-align: center; margin-top: 10px;">  <p>Solder resist Cu Glass Epoxy Board</p> </div>												

* "Room condition" Temperature: 15 to 35°C, Relative humidity: 45 to 75%, Atmospheric pressure: 86 to 106kPa

Continued on the following page. ↗

Specifications and Test Methods

Continued from the preceding page.

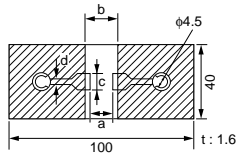
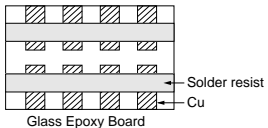
No.	Item	Specifications	Test Method																				
12	Deflection	No cracking or marking defects should occur.	Solder the capacitor to the testing jig (glass epoxy board) shown in Fig. 2. Then apply a force in the direction shown in Fig. 3. The soldering should be done using the reflow method and should be conducted with care so that the soldering is uniform and free of defects such as heat shock.																				
		 <table border="1" style="margin: 10px auto; border-collapse: collapse;"> <thead> <tr> <th rowspan="2">L×W (mm)</th> <th colspan="4">Dimension (mm)</th> </tr> <tr> <th>a</th> <th>b</th> <th>c</th> <th>d</th> </tr> </thead> <tbody> <tr> <td>4.5×2.0</td> <td>3.5</td> <td>7.0</td> <td>2.4</td> <td rowspan="3" style="text-align: center; vertical-align: middle;">1.0</td> </tr> <tr> <td>4.5×3.2</td> <td>3.5</td> <td>7.0</td> <td>3.7</td> </tr> <tr> <td>5.7×5.0</td> <td>4.5</td> <td>8.0</td> <td>5.6</td> </tr> </tbody> </table> <p style="text-align: center;">Fig. 2</p>		L×W (mm)	Dimension (mm)				a	b	c	d	4.5×2.0	3.5	7.0	2.4	1.0	4.5×3.2	3.5	7.0	3.7	5.7×5.0	4.5
L×W (mm)	Dimension (mm)																						
	a	b	c	d																			
4.5×2.0	3.5	7.0	2.4	1.0																			
4.5×3.2	3.5	7.0	3.7																				
5.7×5.0	4.5	8.0	5.6																				
13	Solderability of Termination	75% of the terminations are to be soldered evenly and continuously.	Immerse the capacitor in a solution of ethanol (JIS-K-8101) and rosin (JIS-K-5902) (25% rosin in weight proportion). Immerse in solder solution for 2±0.5 sec. Immersing speed: 25±2.5mm/s Temp. of solder: 245±5°C Lead Free Solder (Sn-3.0Ag-0.5Cu) 235±5°C H60A or H63A Eutectic Solder																				
14	Resistance to Soldering Heat	Appearance	No marking defects																				
		Capacitance Change	Within ±10%																				
		D.F.	0.025 max.																				
		I.R.	More than 1,000MΩ																				
	Dielectric Strength	In accordance with item No.4	Preheat the capacitor as table. Immerse the capacitor in solder solution at 260±5°C for 10±1 sec. Let sit at room condition* for 24±2 hrs., then measure. •Immersing speed: 25±2.5mm/s •Pretreatment Perform a heat treatment at 150±18°C for 60±5 min. and then let sit for 24±2 hrs. at room condition*.																				
			*Preheating <table border="1" style="margin: 10px auto; border-collapse: collapse;"> <thead> <tr> <th>Step</th> <th>Temperature</th> <th>Time</th> </tr> </thead> <tbody> <tr> <td>1</td> <td>100 to 120°C</td> <td>1 min.</td> </tr> <tr> <td>2</td> <td>170 to 200°C</td> <td>1 min.</td> </tr> </tbody> </table>	Step	Temperature	Time	1	100 to 120°C	1 min.	2	170 to 200°C	1 min.											
Step	Temperature	Time																					
1	100 to 120°C	1 min.																					
2	170 to 200°C	1 min.																					
15	Temperature Cycle	Appearance	No marking defects																				
		Capacitance Change	Within ±15%																				
		D.F.	0.05 max.																				
		I.R.	More than 3,000MΩ																				
		Dielectric Strength	In accordance with item No.4																				
			Fix the capacitor to the supporting jig (glass epoxy board) shown in Fig. 4. Perform the 5 cycles according to the 4 heat treatments listed in the following table. Let sit for 24±2 hrs. at room condition*, then measure. <table border="1" style="margin: 10px auto; border-collapse: collapse;"> <thead> <tr> <th>Step</th> <th>Temperature (°C)</th> <th>Time (min.)</th> </tr> </thead> <tbody> <tr> <td>1</td> <td>Min. Operating Temp.±3</td> <td>30±3</td> </tr> <tr> <td>2</td> <td>Room Temp.</td> <td>2 to 3</td> </tr> <tr> <td>3</td> <td>Max. Operating Temp.±2</td> <td>30±3</td> </tr> <tr> <td>4</td> <td>Room Temp.</td> <td>2 to 3</td> </tr> </tbody> </table> •Pretreatment Perform a heat treatment at 150±18°C for 60±5 min. and then let sit for 24±2 hrs. at room condition*.	Step	Temperature (°C)	Time (min.)	1	Min. Operating Temp.±3	30±3	2	Room Temp.	2 to 3	3	Max. Operating Temp.±2	30±3	4	Room Temp.	2 to 3					
Step	Temperature (°C)	Time (min.)																					
1	Min. Operating Temp.±3	30±3																					
2	Room Temp.	2 to 3																					
3	Max. Operating Temp.±2	30±3																					
4	Room Temp.	2 to 3																					
			 <p style="text-align: center;">Fig. 4</p>																				
16	Humidity (Steady State)	Appearance	No marking defects																				
		Capacitance Change	Within ±15%																				
		D.F.	0.05 max.																				
		I.R.	More than 1,000MΩ																				
		Dielectric Strength	In accordance with item No.4																				
			Let the capacitor sit at 40±2°C and relative humidity of 90 to 95% for 500±24 hrs. Remove and let sit for 24±2 hrs. at room condition*, then measure. •Pretreatment Perform a heat treatment at 150±18°C for 60±5 min. and then let sit for 24±2 hrs. at room condition*.																				

* "Room condition" Temperature: 15 to 35°C, Relative humidity: 45 to 75%, Atmospheric pressure: 86 to 106kPa

Continued on the following page. ↗

Specifications and Test Methods

 Continued from the preceding page.

No.	Item	Specifications	Test Method
17	Life	Appearance	Apply 110% of the rated voltage for 1,000 ± 48 hrs. at maximum operating temperature ± 3°C. Remove and let sit for 24 ± 2 hrs. at room condition*, then measure. The charge/discharge current is less than 50mA. •Pretreatment Apply test voltage for 60 ± 5 min. at test temperature. Remove and let sit for 24 ± 2 hrs. at room condition*.
	Capacitance Change	Within ± 20%	
	D.F.	0.05 max.	
	I.R.	More than 2,000MΩ	
	Dielectric Strength	In accordance with item No.4	

* "Room condition" Temperature: 15 to 35°C, Relative humidity: 45 to 75%, Atmospheric pressure: 86 to 106kPa

Chip Monolithic Ceramic Capacitors



Only for Camera Flash Circuit

■ Features

1. Suitable for the trigger of the flash circuit, because real capacitance is stable during operating voltage.
2. The thin type fit for thinner camera.
3. Sn-plated external electrodes realizes good solderability.
4. For flow and reflow soldering

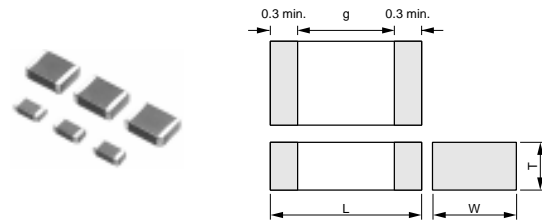

Part Number	Dimensions (mm)			
	L	W	T	g min.
GR731A	3.2 ±0.2	1.6 ±0.2	1.0 +0, -0.3	1.2
GR731B			1.25 +0, -0.3	
GR731C			1.6 ±0.2	

■ Applications

For strobe circuit

Do not use these products in any Automotive Power train or Safety equipment including Battery charger for Electric Vehicles and Plug-in Hybrid. Only Murata products clearly stipulated as **△** for Automotive use **△** on its catalog can be used for automobile applications such as Power train and Safety equipment.

Part Number	Rated Voltage (V)	TC Code (Standard)	Capacitance (pF)	Length L (mm)	Width W (mm)	Thickness T (mm)	Electrode g min. (mm)	Electrode e (mm)
GR731AW0BB103KW01D	DC350	-	10000 ±10%	3.2	1.6	1.0	1.2	0.3 min.
GR731AW0BB153KW01D	DC350	-	15000 ±10%	3.2	1.6	1.0	1.2	0.3 min.
GR731BW0BB223KW01L	DC350	-	22000 ±10%	3.2	1.6	1.25	1.2	0.3 min.
GR731BW0BB333KW01L	DC350	-	33000 ±10%	3.2	1.6	1.25	1.2	0.3 min.
GR731CW0BB473KW03L	DC350	-	47000 ±10%	3.2	1.6	1.6	1.2	0.3 min.

Specifications and Test Methods

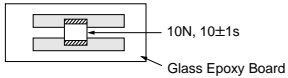
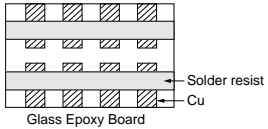
No.	Item	Specifications	Test Method												
1	Operating Temperature Range	-55 to +125°C	—												
2	Appearance	No defects or abnormalities	Visual inspection												
3	Dimensions	Within the specified dimensions	Using calipers												
4	Dielectric Strength	No defects or abnormalities	No failure should be observed when DC500V is applied between the terminations for 1 to 5 sec., provided the charge/discharge current is less than 50mA.												
5	Insulation Resistance (I.R.)	C ≥ 0.01μF: More than 100MΩ • μF C < 0.01μF: More than 10,000MΩ	The insulation resistance should be measured with DC250±50V and within 60±5 sec. of charging.												
6	Capacitance	Within the specified tolerance	The capacitance/D.F. should be measured at a frequency of 1±0.2kHz and a voltage of AC1±0.2V(r.m.s.)												
7	Dissipation Factor (D.F.)	0.025 max.													
8	Capacitance Temperature Characteristics	Cap. Change Within ±10% (Apply DC350V bias) Within ±3% (No DC bias) (Temp. Range : -55 to +125°C)	<p>The capacitance measurement should be made at each step specified in Table.</p> <table border="1"> <thead> <tr> <th>Step</th> <th>Temperature (°C)</th> </tr> </thead> <tbody> <tr> <td>1</td> <td>25±2</td> </tr> <tr> <td>2</td> <td>Min. Operating Temp.±3</td> </tr> <tr> <td>3</td> <td>25±2</td> </tr> <tr> <td>4</td> <td>Max. Operating Temp.±2</td> </tr> <tr> <td>5</td> <td>25±2</td> </tr> </tbody> </table> <p>•Pretreatment Perform a heat treatment at 150±5°C for 60±5 min. and then let sit for 24±2 hrs. at room condition*.</p>	Step	Temperature (°C)	1	25±2	2	Min. Operating Temp.±3	3	25±2	4	Max. Operating Temp.±2	5	25±2
Step	Temperature (°C)														
1	25±2														
2	Min. Operating Temp.±3														
3	25±2														
4	Max. Operating Temp.±2														
5	25±2														
9	Adhesive Strength of Termination	No removal of the terminations or other defect should occur.	<p>Solder the capacitor to the testing jig (glass epoxy board) shown in Fig. 1. Then apply 10N force in the direction of the arrow. The soldering should be done using the reflow method and should be conducted with care so that the soldering is uniform and free of defects such as heat shock.</p>  <p>Fig. 1</p>												
10	Vibration Resistance	Appearance	No defects or abnormalities												
		Capacitance	Within the specified tolerance												
	D.F.	0.025 max.	<p>Solder the capacitor to the test jig (glass epoxy board). The capacitor should be subjected to a simple harmonic motion having a total amplitude of 1.5mm, the frequency being varied uniformly between the approximate limits of 10 and 55Hz. The frequency range, from 10 to 55Hz and return to 10Hz, should be traversed in approximately 1 min. This motion should be applied for a period of 2 hrs. in each of 3 mutually perpendicular directions (total of 6 hrs.).</p> 												

* "Room condition" Temperature: 15 to 35°C, Relative humidity: 45 to 75%, Atmospheric pressure: 86 to 106kPa

Continued on the following page. 

Specifications and Test Methods

Continued from the preceding page.

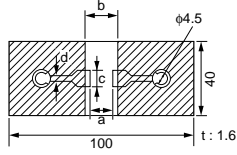
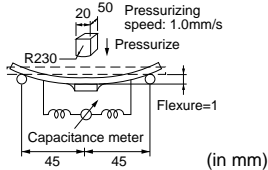
No.	Item	Specifications	Test Method																
11	Deflection	No cracking or marking defects should occur.	Solder the capacitor to the testing jig (glass epoxy board) shown in Fig. 2. Then apply a force in the direction shown in Fig. 3. The soldering should be done using the reflow method and should be conducted with care so that the soldering is uniform and free of defects such as heat shock.																
		 <table border="1" style="margin: 10px auto; border-collapse: collapse;"> <thead> <tr> <th style="text-align: left;">L×W (mm)</th> <th colspan="4" style="text-align: center;">Dimension (mm)</th> </tr> <tr> <th></th> <th style="text-align: center;">a</th> <th style="text-align: center;">b</th> <th style="text-align: center;">c</th> <th style="text-align: center;">d</th> </tr> </thead> <tbody> <tr> <td style="text-align: center;">3.2×1.6</td> <td style="text-align: center;">2.2</td> <td style="text-align: center;">5.0</td> <td style="text-align: center;">2.0</td> <td style="text-align: center;">1.0</td> </tr> </tbody> </table> <p style="text-align: center;">Fig. 2</p>		L×W (mm)	Dimension (mm)					a	b	c	d	3.2×1.6	2.2	5.0	2.0	1.0	 <p style="text-align: center;">Fig. 3</p>
L×W (mm)	Dimension (mm)																		
	a	b	c	d															
3.2×1.6	2.2	5.0	2.0	1.0															
12	Solderability of Termination	75% of the terminations are to be soldered evenly and continuously.	Immerse the capacitor in a solution of ethanol (JIS-K-8101) and rosin (JIS-K-5902) (25% rosin in weight proportion). Immerse in solder solution for 2±0.5 sec. Immersing speed: 25±2.5mm/s Temp. of solder: 245±5°C Lead Free Solder (Sn-3.0Ag-0.5Cu) 235±5°C H60A or H63A Eutectic Solder																
13	Resistance to Soldering Heat	Appearance	No marking defects	Preheat the capacitor at 120 to 150°C* for 1 min. Immerse the capacitor in solder solution at 260±5°C for 10±1 sec. Let sit at room condition* for 24±2 hrs., then measure. •Immersing speed: 25±2.5mm/s •Pretreatment Perform a heat treatment at 150±1°C for 60±5 min. and then let sit for 24±2 hrs. at room condition*.															
		Capacitance Change	Within ±10%																
		D.F.	0.025 max.																
		I.R.	C≥0.01μF: More than 100MΩ • μF C<0.01μF: More than 10,000MΩ																
		Dielectric Strength	In accordance with item No.4																
14	Temperature Cycle	Appearance	No marking defects	Fix the capacitor to the supporting jig (glass epoxy board) shown in Fig. 4. Perform the 5 cycles according to the 4 heat treatments listed in the following table. Let sit for 24±2 hrs. at room condition*, then measure. <table border="1" style="margin: 10px auto; border-collapse: collapse; width: 100%;"> <thead> <tr> <th style="text-align: center;">Step</th> <th style="text-align: center;">Temperature (°C)</th> <th style="text-align: center;">Time (min.)</th> </tr> </thead> <tbody> <tr> <td style="text-align: center;">1</td> <td style="text-align: center;">Min. Operating Temp.±3</td> <td style="text-align: center;">30±3</td> </tr> <tr> <td style="text-align: center;">2</td> <td style="text-align: center;">Room Temp.</td> <td style="text-align: center;">2 to 3</td> </tr> <tr> <td style="text-align: center;">3</td> <td style="text-align: center;">Max. Operating Temp.±2</td> <td style="text-align: center;">30±3</td> </tr> <tr> <td style="text-align: center;">4</td> <td style="text-align: center;">Room Temp.</td> <td style="text-align: center;">2 to 3</td> </tr> </tbody> </table> •Pretreatment Perform a heat treatment at 150±1°C for 60±5 min. and then let sit for 24±2 hrs. at room condition*.	Step	Temperature (°C)	Time (min.)	1	Min. Operating Temp.±3	30±3	2	Room Temp.	2 to 3	3	Max. Operating Temp.±2	30±3	4	Room Temp.	2 to 3
		Step	Temperature (°C)		Time (min.)														
		1	Min. Operating Temp.±3		30±3														
		2	Room Temp.		2 to 3														
		3	Max. Operating Temp.±2		30±3														
4	Room Temp.	2 to 3																	
Capacitance Change	Within ±7.5%																		
D.F.	0.025 max.																		
I.R.	C≥0.01μF: More than 100MΩ • μF C<0.01μF: More than 10,000MΩ																		
Dielectric Strength	In accordance with item No.4																		
15	Humidity (Steady State)	Appearance	No marking defects	Let the capacitor sit at 40±2°C and relative humidity of 90 to 95% for 500±24 hrs. Remove and let sit for 24±2 hrs. at room condition*, then measure. •Pretreatment Perform a heat treatment at 150±1°C for 60±5 min. and then let sit for 24±2 hrs. at room condition*.															
		Capacitance Change	Within ±15%																
		D.F.	0.05 max.																
		I.R.	C≥0.01μF: More than 10MΩ • μF C<0.01μF: More than 1,000MΩ																
		Dielectric Strength	In accordance with item No.4																

* "Room condition" Temperature: 15 to 35°C, Relative humidity: 45 to 75%, Atmospheric pressure: 86 to 106kPa

Continued on the following page.

Specifications and Test Methods

Continued from the preceding page.

No.	Item	Specifications	Test Method	
16	Life	Appearance	Apply DC350V for $1,000 \pm 4\%$ hrs. at maximum operating temperature $\pm 3^\circ\text{C}$. Remove and let sit for 24 ± 2 hrs. at room condition*, then measure. The charge/discharge current is less than 50mA. •Pretreatment Apply test voltage for 60 ± 5 min. at test temperature. Remove and let sit for 24 ± 2 hrs. at room condition*.	
		Capacitance Change		Within $\pm 15\%$
		D.F.		0.05 max.
		I.R.		$C \geq 0.01\mu\text{F}$: More than $10\text{M}\Omega \cdot \mu\text{F}$ $C < 0.01\mu\text{F}$: More than $1,000\text{M}\Omega$
		Dielectric Strength		In accordance with item No.4
17	Humidity Loading	Appearance	Apply the rated voltage at $40 \pm 2^\circ\text{C}$ and relative humidity of 90 to 95% for $500 \pm 2\%$ hrs. Remove and let sit for 24 ± 2 hrs. at room condition*, then measure. •Pretreatment Apply test voltage for 60 ± 5 min. at test temperature. Remove and let sit for 24 ± 2 hrs. at room condition*.	
		Capacitance Change		Within $\pm 15\%$
		D.F.		0.05 max.
		I.R.		$C \geq 0.01\mu\text{F}$: More than $10\text{M}\Omega \cdot \mu\text{F}$ $C < 0.01\mu\text{F}$: More than $1,000\text{M}\Omega$
		Dielectric Strength		In accordance with item No.4

* "Room condition" Temperature: 15 to 35°C , Relative humidity: 45 to 75%, Atmospheric pressure: 86 to 106kPa

Chip Monolithic Ceramic Capacitors



AC250V (r.m.s.) Type (Which Meet Japanese Law)

■ Features

1. Chip monolithic ceramic capacitor for AC lines.
2. A new monolithic structure for small, high capacitance capable of operating at high voltage levels.
3. Sn-plated external electrodes realizes good solderability.
4. Only for reflow soldering
5. Capacitance 0.01 to 0.1uF for connecting lines and 470 to 4700pF for connecting lines to earth.

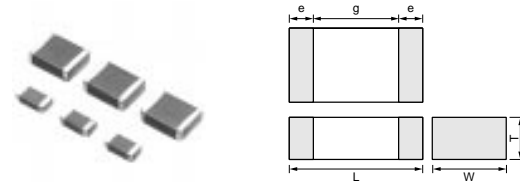

Part Number	Dimensions (mm)				
	L	W	T	e min.	g min.
GA242Q	4.5 ±0.3	2.0 ±0.2	1.5 +0, -0.3	0.3	2.5
GA243D	4.5 ±0.4	3.2 ±0.3	2.0 +0, -0.3		
GA243Q			1.5 +0, -0.3		
GA255D	5.7 ±0.4	5.0 ±0.4	2.0 +0, -0.3		3.2

■ Applications

Noise suppression filters for switching power supplies, telephones, facsimiles, modems.

Do not use these products in any Automotive Power train or Safety equipment including Battery charger for Electric Vehicles and Plug-in Hybrid. Only Murata products clearly stipulated as "for Automotive use" on its catalog can be used for automobile applications such as Power train and Safety equipment.

■ Reference Standard

GA2 series obtains no safety approval. This series is based on the standards of the electrical appliance and material safety law of Japan (separated table 4).

Part Number	Rated Voltage (V)	TC Code (Standard)	Capacitance	Length L (mm)	Width W (mm)	Thickness T (mm)	Electrode g min. (mm)	Electrode e (mm)
GA242QR7E2471MW01L	AC250 (r.m.s.)	X7R (EIA)	470pF ±20%	4.5	2.0	1.5	2.5	0.3 min.
GA242QR7E2102MW01L	AC250 (r.m.s.)	X7R (EIA)	1000pF ±20%	4.5	2.0	1.5	2.5	0.3 min.
GA243QR7E2222MW01L	AC250 (r.m.s.)	X7R (EIA)	2200pF ±20%	4.5	3.2	1.5	2.5	0.3 min.
GA243QR7E2332MW01L	AC250 (r.m.s.)	X7R (EIA)	3300pF ±20%	4.5	3.2	1.5	2.5	0.3 min.
GA243DR7E2472MW01L	AC250 (r.m.s.)	X7R (EIA)	4700pF ±20%	4.5	3.2	2.0	2.5	0.3 min.
GA243QR7E2103MW01L	AC250 (r.m.s.)	X7R (EIA)	10000pF ±20%	4.5	3.2	1.5	2.5	0.3 min.
GA243QR7E2223MW01L	AC250 (r.m.s.)	X7R (EIA)	22000pF ±20%	4.5	3.2	1.5	2.5	0.3 min.
GA243DR7E2473MW01L	AC250 (r.m.s.)	X7R (EIA)	47000pF ±20%	4.5	3.2	2.0	2.5	0.3 min.
GA255DR7E2104MW01L	AC250 (r.m.s.)	X7R (EIA)	0.10µF ±20%	5.7	5.0	2.0	3.2	0.3 min.

Specifications and Test Methods

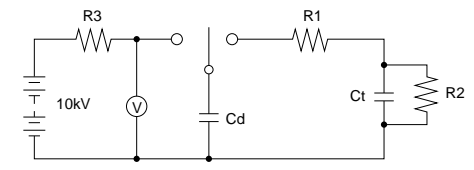
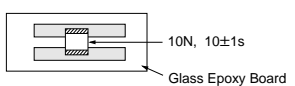
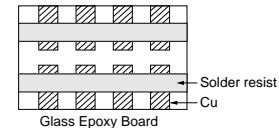
No.	Item	Specifications	Test Method										
1	Operating Temperature Range	-55 to +125°C	—										
2	Appearance	No defects or abnormalities	Visual inspection										
3	Dimensions	Within the specified dimensions	Using calipers										
4	Dielectric Strength	No defects or abnormalities	No failure should be observed when voltage in table is applied between the terminations for 60±1 sec., provided the charge/discharge current is less than 50mA.										
			<table border="1" style="width: 100%; border-collapse: collapse;"> <thead> <tr style="background-color: #f2f2f2;"> <th>Nominal Capacitance</th> <th>Test Voltage</th> </tr> </thead> <tbody> <tr> <td>C≥10,000pF</td> <td>AC575V (r.m.s.)</td> </tr> <tr> <td>C<10,000pF</td> <td>AC1500V (r.m.s.)</td> </tr> </tbody> </table>	Nominal Capacitance	Test Voltage	C≥10,000pF	AC575V (r.m.s.)	C<10,000pF	AC1500V (r.m.s.)				
Nominal Capacitance	Test Voltage												
C≥10,000pF	AC575V (r.m.s.)												
C<10,000pF	AC1500V (r.m.s.)												
5	Insulation Resistance (I.R.)	More than 2,000MΩ	The insulation resistance should be measured with DC500±50V and within 60±5 sec. of charging.										
6	Capacitance	Within the specified tolerance	The capacitance/D.F. should be measured at a frequency of 1±0.2kHz and a voltage of AC1±0.2V (r.m.s.)										
7	Dissipation Factor (D.F.)	0.025 max.											
8	Capacitance Temperature Characteristics	Cap. Change Within ±15% (Temp. Range: -55 to +125°C)	The capacitance measurement should be made at each step specified in Table.										
			<table border="1" style="width: 100%; border-collapse: collapse;"> <thead> <tr style="background-color: #f2f2f2;"> <th>Step</th> <th>Temperature (°C)</th> </tr> </thead> <tbody> <tr> <td>1</td> <td>25±2</td> </tr> <tr> <td>2</td> <td>Min. Operating Temp.±3</td> </tr> <tr> <td>3</td> <td>25±2</td> </tr> <tr> <td>4</td> <td>Max. Operating Temp.±2</td> </tr> <tr> <td>5</td> <td>25±2</td> </tr> </tbody> </table> <p>•Pretreatment Perform a heat treatment at 150±10°C for 60±5 min. and then let sit for 24±2 hrs. at room condition*.</p>	Step	Temperature (°C)	1	25±2	2	Min. Operating Temp.±3	3	25±2	4	Max. Operating Temp.±2
Step	Temperature (°C)												
1	25±2												
2	Min. Operating Temp.±3												
3	25±2												
4	Max. Operating Temp.±2												
5	25±2												
9	Discharge Test (Application: Nominal Capacitance C<10,000pF)	Appearance	No defects or abnormalities										
			<p>As in Fig., discharge is made 50 times at 5 sec. intervals from the capacitor (Cd) charged at DC voltage of specified.</p>  <p style="text-align: center;">Ct: Capacitor under test Cd: 0.001μF R1: 1,000Ω R2: 100MΩ R3: Surge resistance</p>										
10	Adhesive Strength of Termination	No removal of the terminations or other defects should occur.	<p>Solder the capacitor to the testing jig (glass epoxy board) shown in Fig. 1.</p> <p>Then apply 10N force in the direction of the arrow. The soldering should be done using the reflow method and should be conducted with care so that the soldering is uniform and free of defects such as heat shock.</p>  <p style="text-align: center;">Fig. 1</p>										
11	Vibration Resistance	Appearance	No defects or abnormalities										
		Capacitance	Within the specified tolerance										
	D.F.	0.025 max.	<p>Solder the capacitor to the test jig (glass epoxy board). The capacitor should be subjected to a simple harmonic motion having a total amplitude of 1.5mm, the frequency being varied uniformly between the approximate limits of 10 and 55Hz. The frequency range, from 10 to 55Hz and return to 10Hz, should be traversed in approximately 1 min. This motion should be applied for a period of 2 hrs. in each of 3 mutually perpendicular directions (total of 6 hrs.).</p>  <p style="text-align: center;">Glass Epoxy Board</p>										

* "Room condition" Temperature: 15 to 35°C, Relative humidity: 45 to 75%, Atmospheric pressure: 86 to 106kPa

Continued on the following page.

Specifications and Test Methods

Continued from the preceding page.

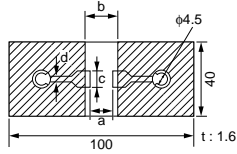
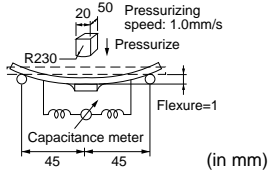
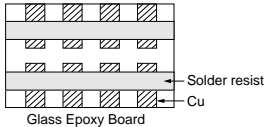
No.	Item	Specifications	Test Method																									
12	Deflection	No cracking or marking defects should occur.	Solder the capacitor to the testing jig (glass epoxy board) shown in Fig. 2. Then apply a force in the direction shown in Fig. 3. The soldering should be done using the reflow method and should be conducted with care so that the soldering is uniform and free of defects such as heat shock.																									
		 <table border="1" style="margin: 10px auto; border-collapse: collapse;"> <thead> <tr> <th rowspan="2">L×W (mm)</th> <th colspan="4">Dimension (mm)</th> </tr> <tr> <th>a</th> <th>b</th> <th>c</th> <th>d</th> </tr> </thead> <tbody> <tr> <td>4.5×2.0</td> <td>3.5</td> <td>7.0</td> <td>2.4</td> <td rowspan="3" style="text-align: center;">1.0</td> </tr> <tr> <td>4.5×3.2</td> <td>3.5</td> <td>7.0</td> <td>3.7</td> </tr> <tr> <td>5.7×5.0</td> <td>4.5</td> <td>8.0</td> <td>5.6</td> </tr> </tbody> </table> <p style="text-align: center;">Fig. 2</p>		L×W (mm)	Dimension (mm)				a	b	c	d	4.5×2.0	3.5	7.0	2.4	1.0	4.5×3.2	3.5	7.0	3.7	5.7×5.0	4.5	8.0	5.6	 <p style="text-align: center;">Fig. 3</p>		
L×W (mm)	Dimension (mm)																											
	a	b	c	d																								
4.5×2.0	3.5	7.0	2.4	1.0																								
4.5×3.2	3.5	7.0	3.7																									
5.7×5.0	4.5	8.0	5.6																									
13	Solderability of Termination	75% of the terminations are to be soldered evenly and continuously.	Immerse the capacitor in a solution of ethanol (JIS-K-8101) and rosin (JIS-K-5902) (25% rosin in weight proportion). Immerse in solder solution for 2±0.5 sec. Immersing speed: 25±2.5mm/s Temp. of solder: 245±5°C Lead Free Solder (Sn-3.0Ag-0.5Cu) 235±5°C H60A or H63A Eutectic Solder																									
14	Humidity Insulation	<table border="1" style="width: 100%; border-collapse: collapse;"> <tr><td style="width: 20%;">Appearance</td><td>No marking defects</td></tr> <tr><td>Capacitance Change</td><td>Within ±15%</td></tr> <tr><td>D.F.</td><td>0.05 max.</td></tr> <tr><td>I.R.</td><td>More than 1,000MΩ</td></tr> <tr><td>Dielectric Strength</td><td>In accordance with item No.4</td></tr> </table>	Appearance	No marking defects	Capacitance Change	Within ±15%	D.F.	0.05 max.	I.R.	More than 1,000MΩ	Dielectric Strength	In accordance with item No.4	The capacitor should be subjected to 40±2°C, relative humidity of 90 to 98% for 8 hrs., and then removed in room condition* for 16 hrs. until 5 cycles.															
Appearance	No marking defects																											
Capacitance Change	Within ±15%																											
D.F.	0.05 max.																											
I.R.	More than 1,000MΩ																											
Dielectric Strength	In accordance with item No.4																											
15	Resistance to Soldering Heat	<table border="1" style="width: 100%; border-collapse: collapse;"> <tr><td style="width: 20%;">Appearance</td><td>No marking defects</td></tr> <tr><td>Capacitance Change</td><td>Within ±10%</td></tr> <tr><td>D.F.</td><td>0.025 max.</td></tr> <tr><td>I.R.</td><td>More than 2,000MΩ</td></tr> <tr><td>Dielectric Strength</td><td>In accordance with item No.4</td></tr> </table>	Appearance	No marking defects	Capacitance Change	Within ±10%	D.F.	0.025 max.	I.R.	More than 2,000MΩ	Dielectric Strength	In accordance with item No.4	Preheat the capacitor as table. Immerse the capacitor in solder solution at 260±5°C for 10±1 sec. Let sit at room condition* for 24±2 hrs., then measure. •Immersing speed: 25±2.5mm/s •Pretreatment Perform a heat treatment at 150±18°C for 60±5 min. and then let sit for 24±2 hrs. at room condition*. *Preheating <table border="1" style="margin: 10px auto; border-collapse: collapse;"> <thead> <tr> <th>Step</th> <th>Temperature</th> <th>Time</th> </tr> </thead> <tbody> <tr> <td style="text-align: center;">1</td> <td style="text-align: center;">100 to 120°C</td> <td style="text-align: center;">1 min.</td> </tr> <tr> <td style="text-align: center;">2</td> <td style="text-align: center;">170 to 200°C</td> <td style="text-align: center;">1 min.</td> </tr> </tbody> </table>	Step	Temperature	Time	1	100 to 120°C	1 min.	2	170 to 200°C	1 min.						
Appearance	No marking defects																											
Capacitance Change	Within ±10%																											
D.F.	0.025 max.																											
I.R.	More than 2,000MΩ																											
Dielectric Strength	In accordance with item No.4																											
Step	Temperature	Time																										
1	100 to 120°C	1 min.																										
2	170 to 200°C	1 min.																										
16	Temperature Cycle	<table border="1" style="width: 100%; border-collapse: collapse;"> <tr><td style="width: 20%;">Appearance</td><td>No marking defects</td></tr> <tr><td>Capacitance Change</td><td>Within ±15%</td></tr> <tr><td>D.F.</td><td>0.05 max.</td></tr> <tr><td>I.R.</td><td>More than 2,000MΩ</td></tr> <tr><td>Dielectric Strength</td><td>In accordance with item No.4</td></tr> </table>	Appearance	No marking defects	Capacitance Change	Within ±15%	D.F.	0.05 max.	I.R.	More than 2,000MΩ	Dielectric Strength	In accordance with item No.4	Fix the capacitor to the supporting jig (glass epoxy board) shown in Fig. 4. Perform the 5 cycles according to the 4 heat treatments listed in the following table. Let sit for 24±2 hrs. at room condition*, then measure. <table border="1" style="margin: 10px auto; border-collapse: collapse;"> <thead> <tr> <th>Step</th> <th>Temperature (°C)</th> <th>Time (min.)</th> </tr> </thead> <tbody> <tr> <td style="text-align: center;">1</td> <td style="text-align: center;">Min. Operating Temp.±3</td> <td style="text-align: center;">30±3</td> </tr> <tr> <td style="text-align: center;">2</td> <td style="text-align: center;">Room Temp.</td> <td style="text-align: center;">2 to 3</td> </tr> <tr> <td style="text-align: center;">3</td> <td style="text-align: center;">Max. Operating Temp.±2</td> <td style="text-align: center;">30±3</td> </tr> <tr> <td style="text-align: center;">4</td> <td style="text-align: center;">Room Temp.</td> <td style="text-align: center;">2 to 3</td> </tr> </tbody> </table> <p>•Pretreatment Perform a heat treatment at 150±18°C for 60±5 min. and then let sit for 24±2 hrs. at room condition*.</p> <div style="text-align: center;">  </div> <p style="text-align: center;">Fig. 4</p>	Step	Temperature (°C)	Time (min.)	1	Min. Operating Temp.±3	30±3	2	Room Temp.	2 to 3	3	Max. Operating Temp.±2	30±3	4	Room Temp.	2 to 3
Appearance	No marking defects																											
Capacitance Change	Within ±15%																											
D.F.	0.05 max.																											
I.R.	More than 2,000MΩ																											
Dielectric Strength	In accordance with item No.4																											
Step	Temperature (°C)	Time (min.)																										
1	Min. Operating Temp.±3	30±3																										
2	Room Temp.	2 to 3																										
3	Max. Operating Temp.±2	30±3																										
4	Room Temp.	2 to 3																										

* "Room condition" Temperature: 15 to 35°C, Relative humidity: 45 to 75%, Atmospheric pressure: 86 to 106kPa

Continued on the following page.

Specifications and Test Methods

Continued from the preceding page.

No.	Item	Specifications	Test Method									
17	Humidity (Steady State)	Appearance	No marking defects									
		Capacitance Change	Within $\pm 15\%$									
		D.F.	0.05 max.									
		I.R.	More than 1,000M Ω									
		Dielectric Strength	In accordance with item No.4									
			Let the capacitor sit at 40 \pm 2 $^{\circ}$ C and relative humidity of 90 to 95% for 500 \pm ²⁴ hrs. Remove and let sit for 24 \pm 2 hrs. at room condition*, then measure. •Pretreatment Perform a heat treatment at 150 \pm 1 $^{\circ}$ C for 60 \pm 5 min. and then let sit for 24 \pm 2 hrs. at room condition*.									
18	Life	Appearance	No marking defects									
		Capacitance Change	Within $\pm 20\%$									
		D.F.	0.05 max.									
		I.R.	More than 1,000M Ω									
		Dielectric Strength	In accordance with item No.4									
			Apply voltage and time as Table at maximum operating temperature $\pm 3^{\circ}$ C. Remove and let sit for 24 \pm 2 hrs. at room condition*, then measure. The charge / discharge current is less than 50mA. <table border="1" style="margin-left: auto; margin-right: auto;"> <thead> <tr> <th>Nominal Capacitance</th> <th>Test Time</th> <th>Test Voltage</th> </tr> </thead> <tbody> <tr> <td>$C \geq 10,000\text{pF}$</td> <td>1,000\pm⁴⁸₉ hrs.</td> <td>AC300V (r.m.s.)</td> </tr> <tr> <td>$C < 10,000\text{pF}$</td> <td>1,500\pm⁴⁸₉ hrs.</td> <td>AC500V (r.m.s.) *</td> </tr> </tbody> </table> * Except that once each hour the voltage is increased to AC1,000V (r.m.s.) for 0.1 sec. •Pretreatment Apply test voltage for 60 \pm 5 min. at test temperature. Remove and let sit for 24 \pm 2 hrs. at room condition*.	Nominal Capacitance	Test Time	Test Voltage	$C \geq 10,000\text{pF}$	1,000 \pm ⁴⁸ ₉ hrs.	AC300V (r.m.s.)	$C < 10,000\text{pF}$	1,500 \pm ⁴⁸ ₉ hrs.	AC500V (r.m.s.) *
Nominal Capacitance	Test Time	Test Voltage										
$C \geq 10,000\text{pF}$	1,000 \pm ⁴⁸ ₉ hrs.	AC300V (r.m.s.)										
$C < 10,000\text{pF}$	1,500 \pm ⁴⁸ ₉ hrs.	AC500V (r.m.s.) *										
19	Humidity Loading	Appearance	No marking defects									
		Capacitance Change	Within $\pm 15\%$									
		D.F.	0.05 max.									
		I.R.	More than 1,000M Ω									
		Dielectric Strength	In accordance with item No.4									
			Apply the rated voltage at 40 \pm 2 $^{\circ}$ C and relative humidity of 90 to 95% for 500 \pm ²⁴ hrs. Remove and let sit for 24 \pm 2 hrs. at room condition*, then measure. •Pretreatment Apply test voltage for 60 \pm 5 min. at test temperature. Remove and let sit for 24 \pm 2 hrs. at room condition*.									

* "Room condition" Temperature: 15 to 35 $^{\circ}$ C, Relative humidity: 45 to 75%, Atmospheric pressure: 86 to 106kPa

Chip Monolithic Ceramic Capacitors



Safety Standard Certified Type GC (UL, IEC60384-14 Class X1/Y2)

■ Features

1. Chip monolithic ceramic capacitor (certified as conforming to safety standards) for AC lines.
2. A new monolithic structure for small, high capacitance capable of operating at high voltage levels.
3. Compared to lead type capacitors, this new capacitor is greatly downsized and low-profiled to 1/10 or less in volume, and 1/4 or less in height.
4. The type GC can be used as an X1-class and Y2-class capacitor, line-by-pass capacitor of UL1414.
5. +125 degree C guaranteed
6. Only for reflow soldering

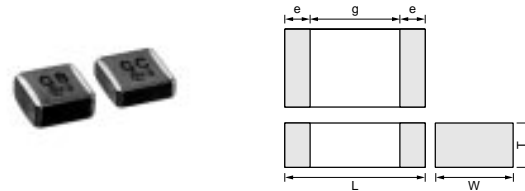

Part Number	Dimensions (mm)				
	L	W	T	e min.	g min.
GA355D	5.7 ±0.4	5.0 ±0.4	2.0 ±0.3	0.3	4.0

■ Applications

1. Ideal for use as Y capacitor or X capacitor for various switching power supplies
2. Ideal for modem applications

Do not use these products in any Automotive Power train or Safety equipment including Battery charger for Electric Vehicles and Plug-in Hybrid. Only Murata products clearly stipulated as "for Automotive use" on its catalog can be used for automobile applications such as Power train and Safety equipment.

■ Standard Certification

	Standard No.	Class	Rated Voltage
UL	UL1414	Line By-pass	AC250V (r.m.s.)
VDE	IEC 60384-14 EN 60384-14	X1, Y2	
BSI	EN 60065 (14.2) IEC 60384-14 EN 60384-14		
SEMKO	IEC 60384-14 EN 60384-14		
ESTI	EN 60065 IEC 60384-14		

Part Number	Rated Voltage (V)	TC Code (Standard)	Capacitance (pF)	Length L (mm)	Width W (mm)	Thickness T (mm)	Electrode g min. (mm)	Electrode e (mm)
GA355DR7GC101KY02L	AC250 (r.m.s.)	X7R (EIA)	100 ±10%	5.7	5.0	2.0	4.0	0.3 min.
GA355DR7GC151KY02L	AC250 (r.m.s.)	X7R (EIA)	150 ±10%	5.7	5.0	2.0	4.0	0.3 min.
GA355DR7GC221KY02L	AC250 (r.m.s.)	X7R (EIA)	220 ±10%	5.7	5.0	2.0	4.0	0.3 min.
GA355DR7GC331KY02L	AC250 (r.m.s.)	X7R (EIA)	330 ±10%	5.7	5.0	2.0	4.0	0.3 min.

Chip Monolithic Ceramic Capacitors



Safety Standard Certified Type GD (IEC60384-14 Class Y3)

■ Features

1. Available for equipment based on IEC/EN60950 and UL1950
2. The type GD can be used as a Y3-class capacitor.
3. A new monolithic structure for small, high capacitance capable of operating at high voltage levels
4. +125 degree C guaranteed
5. Only for reflow soldering
6. The low-profile type (thickness: 1.5mm max.) is available. Fit for use on thinner type equipment.



Part Number	Dimensions (mm)				
	L	W	T	e min.	g min.
GA342A	4.5 ±0.3	2.0 ±0.2	1.0 +0, -0.3	0.3	2.5
GA342D			2.0 ±0.3		
GA342Q			1.5 +0, -0.3		
GA343D	4.5 ±0.4	3.2 ±0.3	2.0 +0, -0.3		
GA343Q			1.5 +0, -0.3		

■ Applications

1. Ideal for use on line filters and couplings for DAA modems without transformers
2. Ideal for use on line filters for information equipment

Do not use these products in any Automotive Power train or Safety equipment including Battery charger for Electric Vehicles and Plug-in Hybrid. Only Murata products clearly stipulated as "for Automotive use" on its catalog can be used for automobile applications such as Power train and Safety equipment.

■ Standard Certification

	Standard No.	Class	Rated Voltage
UL	UL 60950-1	Y3	AC250V(r.m.s.)
SEMKO	IEC 60384-14 EN 60384-14		

Applications		
Size	Switching power supplies	Communication network devices such as a modem
4.5x3.2mm and under	—	⊙

Part Number	Rated Voltage (V)	TC Code (Standard)	Capacitance (pF)	Length L (mm)	Width W (mm)	Thickness T (mm)	Electrode g min. (mm)	Electrode e (mm)
GA342D1XGD100JY02L	AC250 (r.m.s.)	SL (JIS)	10 ±5%	4.5	2.0	2.0	2.5	0.3 min.
GA342D1XGD120JY02L	AC250 (r.m.s.)	SL (JIS)	12 ±5%	4.5	2.0	2.0	2.5	0.3 min.
GA342D1XGD150JY02L	AC250 (r.m.s.)	SL (JIS)	15 ±5%	4.5	2.0	2.0	2.5	0.3 min.
GA342D1XGD180JY02L	AC250 (r.m.s.)	SL (JIS)	18 ±5%	4.5	2.0	2.0	2.5	0.3 min.
GA342D1XGD220JY02L	AC250 (r.m.s.)	SL (JIS)	22 ±5%	4.5	2.0	2.0	2.5	0.3 min.
GA342A1XGD270JW31L	AC250 (r.m.s.)	SL (JIS)	27 ±5%	4.5	2.0	1.0	2.5	0.3 min.
GA342A1XGD330JW31L	AC250 (r.m.s.)	SL (JIS)	33 ±5%	4.5	2.0	1.0	2.5	0.3 min.
GA342A1XGD390JW31L	AC250 (r.m.s.)	SL (JIS)	39 ±5%	4.5	2.0	1.0	2.5	0.3 min.
GA342A1XGD470JW31L	AC250 (r.m.s.)	SL (JIS)	47 ±5%	4.5	2.0	1.0	2.5	0.3 min.
GA342A1XGD560JW31L	AC250 (r.m.s.)	SL (JIS)	56 ±5%	4.5	2.0	1.0	2.5	0.3 min.
GA342A1XGD680JW31L	AC250 (r.m.s.)	SL (JIS)	68 ±5%	4.5	2.0	1.0	2.5	0.3 min.
GA342A1XGD820JW31L	AC250 (r.m.s.)	SL (JIS)	82 ±5%	4.5	2.0	1.0	2.5	0.3 min.
GA342QR7GD101KW01L	AC250 (r.m.s.)	X7R (EIA)	100 ±10%	4.5	2.0	1.5	2.5	0.3 min.
GA342QR7GD151KW01L	AC250 (r.m.s.)	X7R (EIA)	150 ±10%	4.5	2.0	1.5	2.5	0.3 min.
GA342QR7GD221KW01L	AC250 (r.m.s.)	X7R (EIA)	220 ±10%	4.5	2.0	1.5	2.5	0.3 min.
GA342QR7GD331KW01L	AC250 (r.m.s.)	X7R (EIA)	330 ±10%	4.5	2.0	1.5	2.5	0.3 min.
GA342QR7GD471KW01L	AC250 (r.m.s.)	X7R (EIA)	470 ±10%	4.5	2.0	1.5	2.5	0.3 min.
GA342QR7GD681KW01L	AC250 (r.m.s.)	X7R (EIA)	680 ±10%	4.5	2.0	1.5	2.5	0.3 min.
GA342QR7GD102KW01L	AC250 (r.m.s.)	X7R (EIA)	1000 ±10%	4.5	2.0	1.5	2.5	0.3 min.
GA342QR7GD152KW01L	AC250 (r.m.s.)	X7R (EIA)	1500 ±10%	4.5	2.0	1.5	2.5	0.3 min.
GA343QR7GD182KW01L	AC250 (r.m.s.)	X7R (EIA)	1800 ±10%	4.5	3.2	1.5	2.5	0.3 min.
GA343QR7GD222KW01L	AC250 (r.m.s.)	X7R (EIA)	2200 ±10%	4.5	3.2	1.5	2.5	0.3 min.
GA343DR7GD472KW01L	AC250 (r.m.s.)	X7R (EIA)	4700 ±10%	4.5	3.2	2.0	2.5	0.3 min.

Chip Monolithic Ceramic Capacitors



Safety Standard Certified Type GF (IEC60384-14 Class Y2, X1/Y2)

■ Features

1. Available for equipment based on IEC/EN60950 and UL1950. Besides, the GA352/355 types are available for equipment based on IEC/EN60065, UL1492, and UL6500
2. The type GF can be used as a Y2-class capacitor.
3. A new monolithic structure for small, high capacitance capable of operating at high voltage levels
4. +125 degree C guaranteed
5. Only for reflow soldering
6. The low-profile type (thickness: 1.5mm max.) is available. Fit for use on thinner type equipment.

■ Applications

1. Ideal for use on line filters and couplings for DAA modems without transformers
2. Ideal for use on line filters for information equipment
3. Ideal for use as Y capacitor or X capacitor for various switching power supplies (GA352/355 types only)

Do not use these products in any Automotive Power train or Safety equipment including Battery charger for Electric Vehicles and Plug-in Hybrid. Only Murata products clearly stipulated as "for Automotive use" on its catalog can be used for automobile applications such as Power train and Safety equipment.

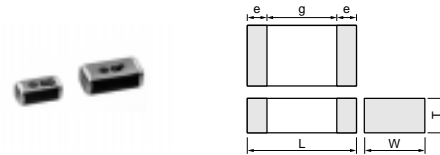

Part Number	Dimensions (mm)			e min.	g min.	
	L	W	T			
GA342A	4.5 ±0.3	2.0 ±0.2	1.0 +0, -0.3	0.3	2.5	
GA342D			2.0 ±0.2*			
GA342Q			1.5 +0, -0.3			
GA352Q	5.7 ±0.4	2.8 ±0.3	1.5 +0, -0.3			4.0
GA355D			2.0 +0, -0.3			
GA355Q			1.5 +0, -0.3			

* GA342D1X : 2.0±0.3

■ Standard Certification

	Standard No.	Class	Status of Certification		Rated Voltage
			Size : 4.5x2.0mm	Size : 5.7x2.8mm and over	
UL	UL1414	X1, Y2	—	⊙	AC250V (r.m.s.)
	UL 60950-1	—	⊙	—	
VDE	IEC 60384-14	X1, Y2	—	⊙	(r.m.s.)
SEMKO	EN 60384-14	Y2	⊙	⊙	

Applications

Size	Switching power supplies	Communication network devices such as a modem
4.5x2.0mm	—	⊙
5.7x2.8mm and over	⊙	⊙

Part Number	Rated Voltage (V)	TC Code (Standard)	Capacitance (pF)	Length L (mm)	Width W (mm)	Thickness T (mm)	Electrode g min. (mm)	Electrode e (mm)
GA342D1XGF100JY02L	AC250 (r.m.s.)	SL (JIS)	10 ±5%	4.5	2.0	2.0	2.5	0.3 min.
GA342D1XGF120JY02L	AC250 (r.m.s.)	SL (JIS)	12 ±5%	4.5	2.0	2.0	2.5	0.3 min.
GA342D1XGF150JY02L	AC250 (r.m.s.)	SL (JIS)	15 ±5%	4.5	2.0	2.0	2.5	0.3 min.
GA342D1XGF180JY02L	AC250 (r.m.s.)	SL (JIS)	18 ±5%	4.5	2.0	2.0	2.5	0.3 min.
GA342D1XGF220JY02L	AC250 (r.m.s.)	SL (JIS)	22 ±5%	4.5	2.0	2.0	2.5	0.3 min.
GA342A1XGF270JW31L	AC250 (r.m.s.)	SL (JIS)	27 ±5%	4.5	2.0	1.0	2.5	0.3 min.
GA342A1XGF330JW31L	AC250 (r.m.s.)	SL (JIS)	33 ±5%	4.5	2.0	1.0	2.5	0.3 min.
GA342A1XGF390JW31L	AC250 (r.m.s.)	SL (JIS)	39 ±5%	4.5	2.0	1.0	2.5	0.3 min.
GA342A1XGF470JW31L	AC250 (r.m.s.)	SL (JIS)	47 ±5%	4.5	2.0	1.0	2.5	0.3 min.
GA342A1XGF560JW31L	AC250 (r.m.s.)	SL (JIS)	56 ±5%	4.5	2.0	1.0	2.5	0.3 min.
GA342A1XGF680JW31L	AC250 (r.m.s.)	SL (JIS)	68 ±5%	4.5	2.0	1.0	2.5	0.3 min.
GA342A1XGF820JW31L	AC250 (r.m.s.)	SL (JIS)	82 ±5%	4.5	2.0	1.0	2.5	0.3 min.
GA342QR7GF101KW01L	AC250 (r.m.s.)	X7R (EIA)	100 ±10%	4.5	2.0	1.5	2.5	0.3 min.
GA342QR7GF151KW01L	AC250 (r.m.s.)	X7R (EIA)	150 ±10%	4.5	2.0	1.5	2.5	0.3 min.
GA342DR7GF221KW02L	AC250 (r.m.s.)	X7R (EIA)	220 ±10%	4.5	2.0	2.0	2.5	0.3 min.
GA342DR7GF331KW02L	AC250 (r.m.s.)	X7R (EIA)	330 ±10%	4.5	2.0	2.0	2.5	0.3 min.
GA342QR7GF471KW01L	AC250 (r.m.s.)	X7R (EIA)	470 ±10%	4.5	2.0	1.5	2.5	0.3 min.
GA352QR7GF471KW01L	AC250 (r.m.s.)	X7R (EIA)	470 ±10%	5.7	2.8	1.5	4.0	0.3 min.
GA342QR7GF681KW01L	AC250 (r.m.s.)	X7R (EIA)	680 ±10%	4.5	2.0	1.5	2.5	0.3 min.

Continued on the following page.

Continued from the preceding page.

Part Number	Rated Voltage (V)	TC Code (Standard)	Capacitance (pF)	Length L (mm)	Width W (mm)	Thickness T (mm)	Electrode g min. (mm)	Electrode e (mm)
GA352QR7GF681KW01L	AC250 (r.m.s.)	X7R (EIA)	680 ±10%	5.7	2.8	1.5	4.0	0.3 min.
GA342DR7GF102KW02L	AC250 (r.m.s.)	X7R (EIA)	1000 ±10%	4.5	2.0	2.0	2.5	0.3 min.
GA352QR7GF102KW01L	AC250 (r.m.s.)	X7R (EIA)	1000 ±10%	5.7	2.8	1.5	4.0	0.3 min.
GA352QR7GF152KW01L	AC250 (r.m.s.)	X7R (EIA)	1500 ±10%	5.7	2.8	1.5	4.0	0.3 min.
GA355QR7GF182KW01L	AC250 (r.m.s.)	X7R (EIA)	1800 ±10%	5.7	5.0	1.5	4.0	0.3 min.
GA355QR7GF222KW01L	AC250 (r.m.s.)	X7R (EIA)	2200 ±10%	5.7	5.0	1.5	4.0	0.3 min.
GA355QR7GF332KW01L	AC250 (r.m.s.)	X7R (EIA)	3300 ±10%	5.7	5.0	1.5	4.0	0.3 min.
GA355DR7GF472KW01L	AC250 (r.m.s.)	X7R (EIA)	4700 ±10%	5.7	5.0	2.0	4.0	0.3 min.

Chip Monolithic Ceramic Capacitors



Safety Standard Certified Type GB (IEC60384-14 Class X2)

■ Features

1. The type GB can be used as an X2-class capacitor.
2. Chip monolithic ceramic capacitor (certified as conforming to safety standards) for AC lines
3. A new monolithic structure for small, high capacitance capable of operating at high voltage levels
4. Compared to lead type capacitors, this new capacitor is greatly downsized and low-profiled to 1/10 or less in volume, and 1/4 or less in height.
5. +125 degree C guaranteed
6. Only for reflow soldering

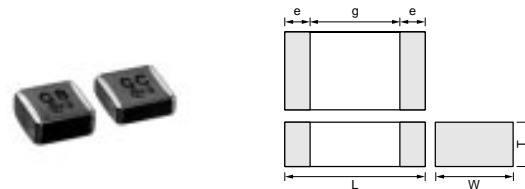

Part Number	Dimensions (mm)				
	L	W	T	e min.	g min.
GA355Q	5.7 ±0.4	5.0 ±0.4	1.5 +0,-0.3	0.3	3.0
GA355D			2.0 +0,-0.3		
GA355E			2.5 +0,-0.3		
GA355X			2.9 +0,-0.4		

■ Applications

Ideal for use as X capacitor for various switching power supplies

Do not use these products in any Automotive Power train or Safety equipment including Battery charger for Electric Vehicles and Plug-in Hybrid. Only Murata products clearly stipulated as "for Automotive use" on its catalog can be used for automobile applications such as Power train and Safety equipment.

■ Standard Certification

	Standard No.	Class	Rated Voltage
VDE	IEC 60384-14 EN 60384-14	X2	AC250V (r.m.s.)
SEMKO			
ESTI			

Part Number	Rated Voltage (V)	TC Code (Standard)	Capacitance (pF)	Length L (mm)	Width W (mm)	Thickness T (mm)	Electrode g min. (mm)	Electrode e (mm)
GA355QR7GB103KW01L	AC250 (r.m.s.)	X7R (EIA)	10000 ±10%	5.7	5.0	1.5	3.0	0.3 min.
GA355QR7GB153KW01L	AC250 (r.m.s.)	X7R (EIA)	15000 ±10%	5.7	5.0	1.5	3.0	0.3 min.
GA355DR7GB223KW01L	AC250 (r.m.s.)	X7R (EIA)	22000 ±10%	5.7	5.0	2.0	3.0	0.3 min.
GA355ER7GB333KW01L	AC250 (r.m.s.)	X7R (EIA)	33000 ±10%	5.7	5.0	2.5	3.0	0.3 min.
GA355ER7GB473KW01L	AC250 (r.m.s.)	X7R (EIA)	47000 ±10%	5.7	5.0	2.5	3.0	0.3 min.
GA355XR7GB563KW06L	AC250 (r.m.s.)	X7R (EIA)	56000 ±10%	5.7	5.0	2.9	3.0	0.3 min.

GA3 Series Specifications and Test Methods

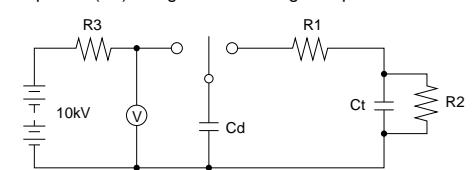
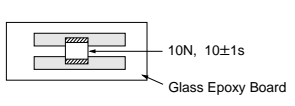
No.	Item	Specifications	Test Method																				
1	Operating Temperature Range	-55 to +125°C	—																				
2	Appearance	No defects or abnormalities	Visual inspection																				
3	Dimensions	Within the specified dimensions	Using calipers																				
4	Dielectric Strength	No defects or abnormalities	No failure should be observed when voltage in table is applied between the terminations for 60±1 sec., provided the charge/discharge current is less than 50mA. <table border="1"> <thead> <tr> <th></th> <th>Test Voltage</th> </tr> </thead> <tbody> <tr> <td>Type GB</td> <td>DC1075V</td> </tr> <tr> <td>Type GC/GD/GF</td> <td>AC1500V (r.m.s.)</td> </tr> </tbody> </table>		Test Voltage	Type GB	DC1075V	Type GC/GD/GF	AC1500V (r.m.s.)														
	Test Voltage																						
Type GB	DC1075V																						
Type GC/GD/GF	AC1500V (r.m.s.)																						
5	Pulse Voltage (Application: Type GD/GF)	No self healing breakdowns or flash-overs have taken place in the capacitor.	10 impulse of alternating polarity is subjected. (5 impulse for each polarity) The interval between impulse is 60 sec. Applied Voltage: 2.5kV zero to peak																				
6	Insulation Resistance (I.R.)	More than 6,000MΩ	The insulation resistance should be measured with DC500±50V and within 60±5 sec. of charging.																				
7	Capacitance	Within the specified tolerance																					
8	Dissipation Factor (D.F.) Q	<table border="1"> <thead> <tr> <th>Char.</th> <th>Specification</th> </tr> </thead> <tbody> <tr> <td>X7R</td> <td>D.F. ≤ 0.025</td> </tr> <tr> <td>SL</td> <td>Q ≥ 400+20C*2 (C < 30pF) Q ≥ 1000 (C ≥ 30pF)</td> </tr> </tbody> </table>	Char.	Specification	X7R	D.F. ≤ 0.025	SL	Q ≥ 400+20C*2 (C < 30pF) Q ≥ 1000 (C ≥ 30pF)	The capacitance/Q/D.F. should be measured at a frequency of 1±0.2kHz (SL char.: 1±0.2MHz) and a voltage of AC1±0.2V (r.m.s.)														
Char.	Specification																						
X7R	D.F. ≤ 0.025																						
SL	Q ≥ 400+20C*2 (C < 30pF) Q ≥ 1000 (C ≥ 30pF)																						
9	Capacitance Temperature Characteristics	<table border="1"> <thead> <tr> <th>Char.</th> <th>Capacitance Change</th> </tr> </thead> <tbody> <tr> <td>X7R</td> <td>Within ±15%</td> </tr> </tbody> </table> Temperature characteristic guarantee is -55 to +125°C <table border="1"> <thead> <tr> <th>Char.</th> <th>Temperature Coefficient</th> </tr> </thead> <tbody> <tr> <td>SL</td> <td>+350 to -1000ppm/°C</td> </tr> </tbody> </table> Temperature characteristic guarantee is +20 to +85°C	Char.	Capacitance Change	X7R	Within ±15%	Char.	Temperature Coefficient	SL	+350 to -1000ppm/°C	The capacitance measurement should be made at each step specified in Table. <table border="1"> <thead> <tr> <th>Step</th> <th>Temperature (°C)</th> </tr> </thead> <tbody> <tr> <td>1</td> <td>25±2 (20±2 for SL char.)</td> </tr> <tr> <td>2</td> <td>Min. Operating Temp. ±3</td> </tr> <tr> <td>3</td> <td>25±2 (20±2 for SL char.)</td> </tr> <tr> <td>4</td> <td>Max. Operating Temp. ±2</td> </tr> <tr> <td>5</td> <td>25±2 (20±2 for SL char.)</td> </tr> </tbody> </table> SL char. : The capacitance should be measured at even 85°C between step 3 and step 4. •Pretreatment for X7R char. Perform a heat treatment at 150±3°C for 60±5 min. and then let sit for 24±2 hrs. at room condition*1.	Step	Temperature (°C)	1	25±2 (20±2 for SL char.)	2	Min. Operating Temp. ±3	3	25±2 (20±2 for SL char.)	4	Max. Operating Temp. ±2	5	25±2 (20±2 for SL char.)
Char.	Capacitance Change																						
X7R	Within ±15%																						
Char.	Temperature Coefficient																						
SL	+350 to -1000ppm/°C																						
Step	Temperature (°C)																						
1	25±2 (20±2 for SL char.)																						
2	Min. Operating Temp. ±3																						
3	25±2 (20±2 for SL char.)																						
4	Max. Operating Temp. ±2																						
5	25±2 (20±2 for SL char.)																						
10	Appearance	No defects or abnormalities	As in Fig., discharge is made 50 times at 5 sec. intervals from the capacitor (Cd) charged at DC voltage of specified.  Ct: Capacitor under test Cd: 0.001μF R1: 1,000Ω R2: 100MΩ R3: Surge resistance																				
	I.R.	More than 1,000MΩ																					
	Dielectric Strength	In accordance with item No.4																					
11	Adhesive Strength of Termination	No removal of the terminations or other defect should occur.	Solder the capacitor to the testing jig (glass epoxy board) shown in Fig. 1. Then apply 10N force in the direction of the arrow. The soldering should be done using the reflow method and should be conducted with care so that the soldering is uniform and free of defects such as heat shock.  Fig. 1																				

*1 "Room condition" Temperature: 15 to 35°C, Relative humidity: 45 to 75%, Atmospheric pressure: 86 to 106kPa

*2 "C" expresses nominal capacitance value (pF).

Continued on the following page. 

GA3 Series Specifications and Test Methods

Continued from the preceding page.

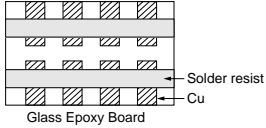
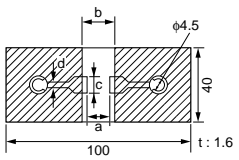
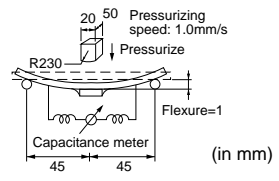
No.	Item	Specifications	Test Method																										
12	Vibration Resistance	<table border="1" style="width: 100%; border-collapse: collapse;"> <tr> <td style="width: 15%;">Appearance</td> <td>No defects or abnormalities</td> </tr> <tr> <td>Capacitance</td> <td>Within the specified tolerance</td> </tr> <tr> <td style="text-align: center;">D.F. Q</td> <td> <table border="1" style="width: 100%; border-collapse: collapse;"> <tr> <th style="width: 15%;">Char.</th> <th>Specification</th> </tr> <tr> <td>X7R</td> <td>D.F. ≤ 0.025</td> </tr> <tr> <td>SL</td> <td>Q ≥ 400 + 20C** (C < 30pF) Q ≥ 1000 (C ≥ 30pF)</td> </tr> </table> </td> </tr> </table>	Appearance	No defects or abnormalities	Capacitance	Within the specified tolerance	D.F. Q	<table border="1" style="width: 100%; border-collapse: collapse;"> <tr> <th style="width: 15%;">Char.</th> <th>Specification</th> </tr> <tr> <td>X7R</td> <td>D.F. ≤ 0.025</td> </tr> <tr> <td>SL</td> <td>Q ≥ 400 + 20C** (C < 30pF) Q ≥ 1000 (C ≥ 30pF)</td> </tr> </table>	Char.	Specification	X7R	D.F. ≤ 0.025	SL	Q ≥ 400 + 20C** (C < 30pF) Q ≥ 1000 (C ≥ 30pF)	<p>Solder the capacitor to the test jig (glass epoxy board). The capacitor should be subjected to a simple harmonic motion having a total amplitude of 1.5mm, the frequency being varied uniformly between the approximate limits of 10 and 55Hz. The frequency range, from 10 to 55Hz and return to 10Hz, should be traversed in approximately 1 min. This motion should be applied for a period of 2 hrs. in each of 3 mutually perpendicular directions (total of 6 hrs.).</p> <div style="text-align: center;">  <p style="font-size: small;">Solder resist Cu Glass Epoxy Board</p> </div>														
	Appearance	No defects or abnormalities																											
Capacitance	Within the specified tolerance																												
D.F. Q	<table border="1" style="width: 100%; border-collapse: collapse;"> <tr> <th style="width: 15%;">Char.</th> <th>Specification</th> </tr> <tr> <td>X7R</td> <td>D.F. ≤ 0.025</td> </tr> <tr> <td>SL</td> <td>Q ≥ 400 + 20C** (C < 30pF) Q ≥ 1000 (C ≥ 30pF)</td> </tr> </table>	Char.	Specification	X7R	D.F. ≤ 0.025	SL	Q ≥ 400 + 20C** (C < 30pF) Q ≥ 1000 (C ≥ 30pF)																						
Char.	Specification																												
X7R	D.F. ≤ 0.025																												
SL	Q ≥ 400 + 20C** (C < 30pF) Q ≥ 1000 (C ≥ 30pF)																												
13	Deflection	No cracking or marking defects should occur.	<p>Solder the capacitor to the testing jig (glass epoxy board) shown in Fig. 2. Then apply a force in the direction shown in Fig. 3. The soldering should be done using the reflow method and should be conducted with care so that the soldering is uniform and free of defects such as heat shock.</p> <div style="text-align: center;">  <table border="1" style="margin-top: 10px; border-collapse: collapse;"> <thead> <tr> <th rowspan="2">L×W (mm)</th> <th colspan="4">Dimension (mm)</th> </tr> <tr> <th>a</th> <th>b</th> <th>c</th> <th>d</th> </tr> </thead> <tbody> <tr> <td>4.5×2.0</td> <td>3.5</td> <td>7.0</td> <td>2.4</td> <td rowspan="5" style="text-align: center; vertical-align: middle;">1.0</td> </tr> <tr> <td>4.5×3.2</td> <td>3.5</td> <td>7.0</td> <td>3.7</td> </tr> <tr> <td>5.7×2.8</td> <td>4.5</td> <td>8.0</td> <td>3.2</td> </tr> <tr> <td>5.7×5.0</td> <td>4.5</td> <td>8.0</td> <td>5.6</td> </tr> </tbody> </table> <p style="text-align: center; font-size: small;">Fig. 2</p> </div>	L×W (mm)	Dimension (mm)				a	b	c	d	4.5×2.0	3.5	7.0	2.4	1.0	4.5×3.2	3.5	7.0	3.7	5.7×2.8	4.5	8.0	3.2	5.7×5.0	4.5	8.0	5.6
		L×W (mm)			Dimension (mm)																								
a	b		c	d																									
4.5×2.0	3.5	7.0	2.4	1.0																									
4.5×3.2	3.5	7.0	3.7																										
5.7×2.8	4.5	8.0	3.2																										
5.7×5.0	4.5	8.0	5.6																										
			<div style="text-align: center;">  <p style="text-align: center; font-size: small;">Fig. 3</p> </div>																										
14	Solderability of Termination	75% of the terminations are to be soldered evenly and continuously.	<p>Immerse the capacitor in a solution of ethanol (JIS-K-8101) and rosin (JIS-K-5902) (25% rosin in weight proportion). Immerse in solder solution for 2±0.5 sec. Immersing speed: 25±2.5mm/s Temp. of solder: 245±5°C Lead Free Solder (Sn-3.0Ag-0.5Cu) 235±5°C H60A or H63A Eutectic Solder</p>																										
15	Appearance	No marking defects	<p>Preheat the capacitor as table. Immerse the capacitor in solder solution at 260±5°C for 10±1 sec. Let sit at room condition*1 for 24±2 hrs., then measure.</p> <ul style="list-style-type: none"> • Immersing speed: 25±2.5mm/s • Pretreatment for X7R char. Perform a heat treatment at 150±10°C for 60±5 min. and then let sit for 24±2 hrs. at room condition*1. <p>*Preheating</p> <table border="1" style="width: 100%; border-collapse: collapse; text-align: center;"> <thead> <tr> <th style="width: 15%;">Step</th> <th style="width: 45%;">Temperature</th> <th style="width: 40%;">Time</th> </tr> </thead> <tbody> <tr> <td>1</td> <td>100 to 120°C</td> <td>1 min.</td> </tr> <tr> <td>2</td> <td>170 to 200°C</td> <td>1 min.</td> </tr> </tbody> </table>	Step	Temperature	Time	1	100 to 120°C	1 min.	2	170 to 200°C	1 min.																	
	Step	Temperature		Time																									
	1	100 to 120°C		1 min.																									
	2	170 to 200°C		1 min.																									
Resistance to Soldering Heat	<table border="1" style="width: 100%; border-collapse: collapse;"> <tr> <th style="width: 15%;">Char.</th> <th>Capacitance Change</th> </tr> <tr> <td>X7R</td> <td>Within ±10%</td> </tr> <tr> <td>SL</td> <td>Within ±2.5% or ±0.25pF (Whichever is larger)</td> </tr> </table>	Char.	Capacitance Change	X7R	Within ±10%	SL	Within ±2.5% or ±0.25pF (Whichever is larger)																						
Char.	Capacitance Change																												
X7R	Within ±10%																												
SL	Within ±2.5% or ±0.25pF (Whichever is larger)																												
I.R.	More than 1,000MΩ																												
Dielectric Strength	In accordance with item No.4																												

*1 "Room condition" Temperature: 15 to 35°C, Relative humidity: 45 to 75%, Atmospheric pressure: 86 to 106kPa

*2 "C" expresses nominal capacitance value (pF).

Continued on the following page. ↗

GA3 Series Specifications and Test Methods

Continued from the preceding page.

No.	Item	Specifications	Test Method	
16	Temperature Cycle	Appearance	No marking defects	
		Capacitance Change	Char. X7R	Capacitance Change Within $\pm 15\%$
			SL	Within $\pm 2.5\%$ or $\pm 0.25\text{pF}$ (Whichever is larger)
		D.F. Q	Char. X7R	Specification D.F. ≤ 0.05
			SL	$Q \geq 400 + 20C^{*2}$ ($C < 30\text{pF}$) $Q \geq 1000$ ($C \geq 30\text{pF}$)
I.R.	More than 3,000M Ω			
Dielectric Strength	In accordance with item No.4			
17	Humidity (Steady State)	Appearance	No marking defects	
		Capacitance Change	Char. X7R	Capacitance Change Within $\pm 15\%$
			SL	Within $\pm 5.0\%$ or $\pm 0.5\text{pF}$ (Whichever is larger)
		D.F. Q	Char. X7R	Specification D.F. ≤ 0.05
			SL	$Q \geq 275 + 5/2C^{*2}$ ($C < 30\text{pF}$) $Q \geq 350$ ($C \geq 30\text{pF}$)
I.R.	More than 3,000M Ω			
Dielectric Strength	In accordance with item No.4			
18	Life	Appearance	No marking defects	
		Capacitance Change	Char. X7R	Capacitance Change Within $\pm 20\%$
			SL	Within $\pm 3.0\%$ or $\pm 0.3\text{pF}$ (Whichever is larger)
		D.F. Q	Char. X7R	Specification D.F. ≤ 0.05
			SL	$Q \geq 275 + 5/2C^{*2}$ ($C < 30\text{pF}$) $Q \geq 350$ ($C \geq 30\text{pF}$)
I.R.	More than 3,000M Ω			
Dielectric Strength	In accordance with item No.4			

Fix the capacitor to the supporting jig (glass epoxy board) shown in Fig. 4.
 Perform the 5 cycles according to the 4 heat treatments listed in the following table.
 Let sit for 24 \pm 2 hrs. at room condition^{*1}, then measure.

Step	Temperature (°C)	Time (min.)
1	Min. Operating Temp. ± 3	30 \pm 3
2	Room Temp.	2 to 3
3	Max. Operating Temp. ± 2	30 \pm 3
4	Room Temp.	2 to 3

•Pretreatment for X7R char.

Perform a heat treatment at 150 \pm 1 $^{\circ}$ C for 60 \pm 5 min. and then let sit for 24 \pm 2 hrs. at room condition^{*1}.

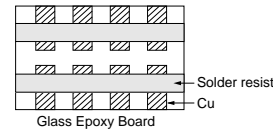

Fig. 4

Before this test, the test shown in the following is performed.

- Item 11 Adhesive Strength of Termination (applied force is 5N)
- Item 13 Deflection

Let the capacitor sit at 40 \pm 2 $^{\circ}$ C and relative humidity of 90 to 95% for 500 \pm 24 hrs.

Remove and let sit for 24 \pm 2 hrs. at room condition^{*1}, then measure.

•Pretreatment for X7R char.

Perform a heat treatment at 150 \pm 1 $^{\circ}$ C for 60 \pm 5 min. and then let sit for 24 \pm 2 hrs. at room condition^{*1}.

Before this test, the test shown in the following is performed.

- Item 11 Adhesive Strength of Termination (apply force is 5N)
- Item 13 Deflection

Impulse Voltage
 Each individual capacitor should be subjected to a 2.5kV (Type GC/GF: 5kV) Impulse (the voltage value means zero to peak) for three times. Then the capacitors are applied to life test.

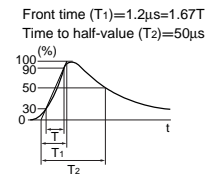

Apply voltage as Table for 1,000 hrs. at 125 \pm 2 $^{\circ}$ C, relative humidity 50% max.

Type	Applied Voltage
GB	AC312.5V (r.m.s.), except that once each hour the voltage is increased to AC1,000V (r.m.s.) for 0.1 sec.
GC	AC425V (r.m.s.), except that once each hour the voltage is increased to AC1,000V (r.m.s.) for 0.1 sec.
GD	

Let sit for 24 \pm 2 hrs. at room condition^{*1}, then measure.

•Pretreatment for X7R char.

Perform a heat treatment at 150 \pm 1 $^{\circ}$ C for 60 \pm 5 min. and then let sit for 24 \pm 2 hrs. at room condition^{*1}.

*1 "Room condition" Temperature: 15 to 35 $^{\circ}$ C, Relative humidity: 45 to 75%, Atmospheric pressure: 86 to 106kPa

*2 "C" expresses nominal capacitance value (pF).

Continued on the following page.

GA3 Series Specifications and Test Methods

Continued from the preceding page.

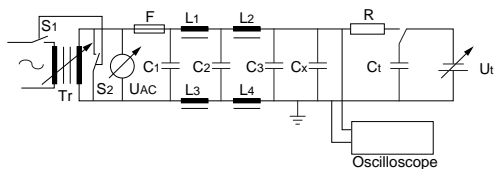
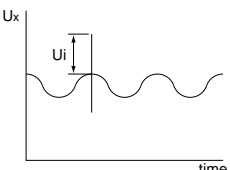
No.	Item	Specifications	Test Method						
19	Appearance	No marking defects	Before this test, the test shown in the following is performed. -Item 11 Adhesive Strength of Termination (apply force is 5N) -Item 13 Deflection Apply the rated voltage at 40±2°C and relative humidity of 90 to 95% for 500 ^{±20} hrs. Remove and let sit for 24±2 hrs. at room condition*1, then measure. •Pretreatment for X7R char. Perform a heat treatment at 150 ^{±10} °C for 60±5 min. and then let sit for 24±2 hrs. at room condition*1.						
	Capacitance Change	<table border="1" style="width: 100%; border-collapse: collapse;"> <thead> <tr style="background-color: #e0e0e0;"> <th style="width: 30%;">Char.</th> <th>Capacitance Change</th> </tr> </thead> <tbody> <tr> <td>X7R</td> <td>Within ±15%</td> </tr> <tr> <td>SL</td> <td>Within ±5.0% or ±0.5pF (Whichever is larger)</td> </tr> </tbody> </table>		Char.	Capacitance Change	X7R	Within ±15%	SL	Within ±5.0% or ±0.5pF (Whichever is larger)
	Char.	Capacitance Change							
	X7R	Within ±15%							
	SL	Within ±5.0% or ±0.5pF (Whichever is larger)							
D.F. Q	<table border="1" style="width: 100%; border-collapse: collapse;"> <thead> <tr style="background-color: #e0e0e0;"> <th style="width: 30%;">Char.</th> <th>Specification</th> </tr> </thead> <tbody> <tr> <td>X7R</td> <td>D.F. ≤0.05</td> </tr> <tr> <td>SL</td> <td>Q ≥ 275+5/2C*2 (C<30pF) Q ≥ 350 (C ≥ 30pF)</td> </tr> </tbody> </table>	Char.	Specification	X7R	D.F. ≤0.05	SL	Q ≥ 275+5/2C*2 (C<30pF) Q ≥ 350 (C ≥ 30pF)		
Char.	Specification								
X7R	D.F. ≤0.05								
SL	Q ≥ 275+5/2C*2 (C<30pF) Q ≥ 350 (C ≥ 30pF)								
I.R.	More than 3,000MΩ								
Dielectric Strength	In accordance with item No.4								
20	Active Flammability	The cheesecloth should not be on fire.	The capacitor should be individually wrapped in at least one but not more than two complete layers of cheesecloth. The capacitor should be subjected to 20 discharges. The interval between successive discharges should be 5 sec. The UAC should be maintained for 2 min. after the last discharge.						
			 <p style="margin-left: 20px;"> C1,2 : 1μF±10% C3 : 0.033μF±5% 10kV L1 to 4 : 1.5mH±20% 16A Rod core choke Ct : 3μF±5% 10kV R : 100Ω±2% Cx : Capacitor under test UAC : UR±5% F : Fuse, Rated 16A UR : Rated Voltage Ut : Voltage applied to Ct </p>  <table border="1" style="margin-left: 20px; border-collapse: collapse;"> <thead> <tr style="background-color: #e0e0e0;"> <th>Type</th> <th>Ui</th> </tr> </thead> <tbody> <tr> <td>GB, GD</td> <td>2.5kV</td> </tr> <tr> <td>GC, GF</td> <td>5kV</td> </tr> </tbody> </table>	Type	Ui	GB, GD	2.5kV	GC, GF	5kV
Type	Ui								
GB, GD	2.5kV								
GC, GF	5kV								
21	Passive Flammability	The burning time should not exceed 30 sec. The tissue paper should not ignite.	The capacitor under test should be held in the flame in the position which best promotes burning. Each specimen should only be exposed once to the flame. Time of exposure to flame: 30 sec. Length of flame: 12±1mm Gas burner : Length 35mm min. Inside Dia. 0.5±0.1mm Outside Dia. 0.9mm max. Gas : Butane gas Purity 95% min.						

*1 "Room condition" Temperature: 15 to 35°C, Relative humidity: 45 to 75%, Atmospheric pressure: 86 to 106kPa

*2 "C" expresses nominal capacitance value (pF).

GRM/GR4/GR7/GA2/GA3 Series Data (Typical Example)

■ Capacitance - Temperature Characteristics

C0G/U2J/SL Characteristics

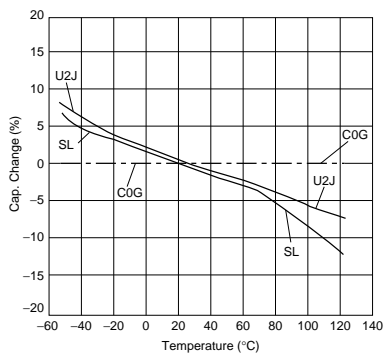

X7R Characteristics

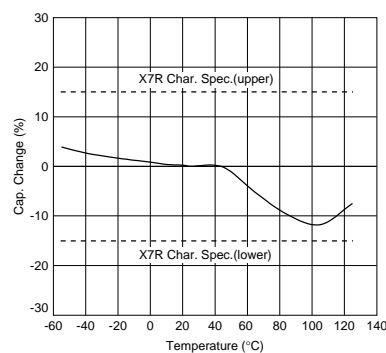

GR4 Series

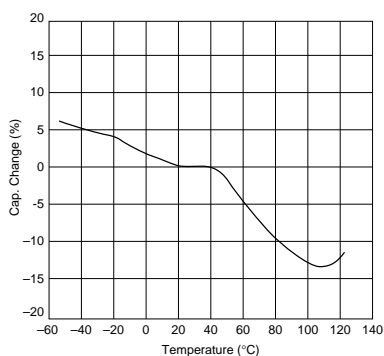

■ Impedance - Frequency Characteristics

GRM Series (C0G Char. 630V)

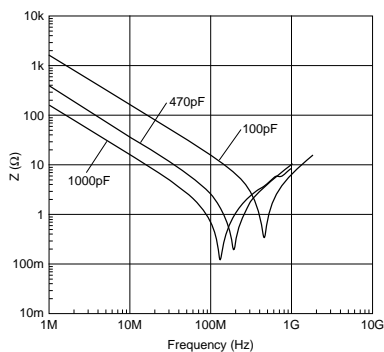

GRM Series (X7R Char. 250V)

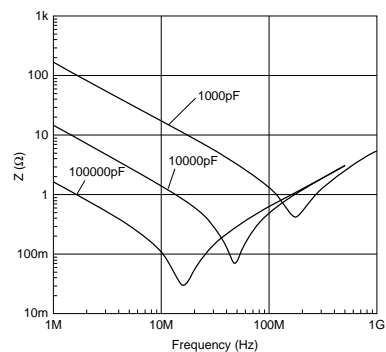

Continued on the following page. ↗

GRM/GR4/GR7/GA2/GA3 Series Data (Typical Example)

Continued from the preceding page.

Impedance - Frequency Characteristics

GRM Series (X7R Char. 630V)

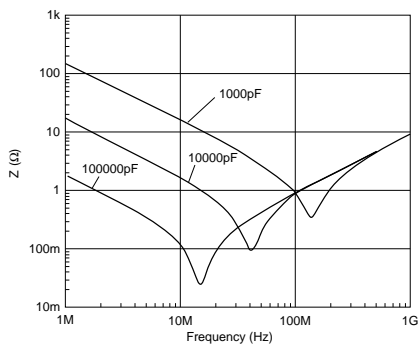

GR4 Series

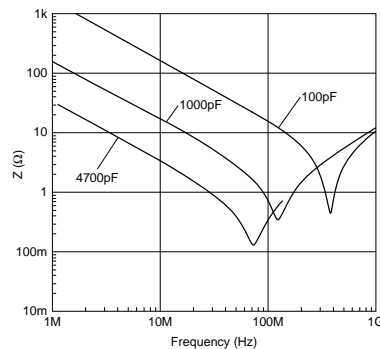

GR7 Series

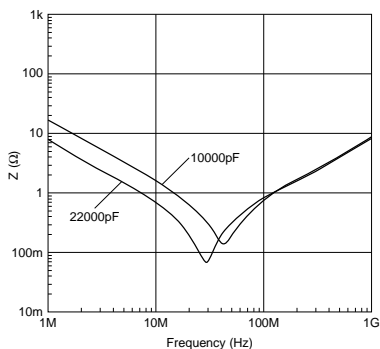

GA2 Series

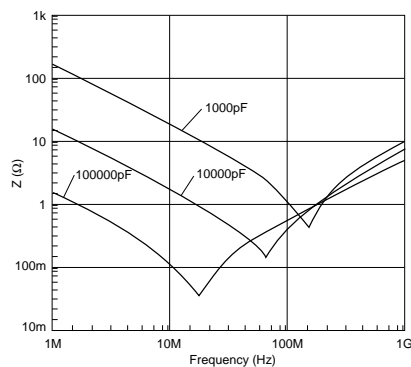

GA3 Series (Type GD)

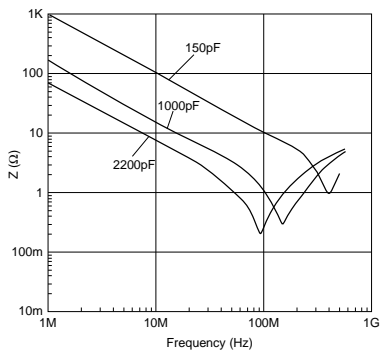

GA3 Series (Type GF)

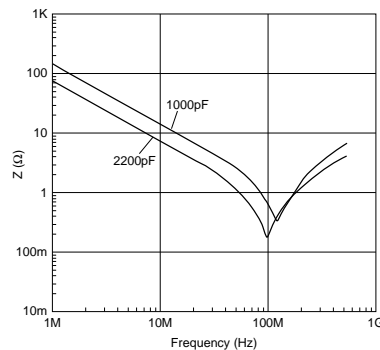

Continued on the following page. ↗

GRM/GR4/GR7/GA2/GA3 Series Data (Typical Example)

Continued from the preceding page.

Impedance - Frequency Characteristics

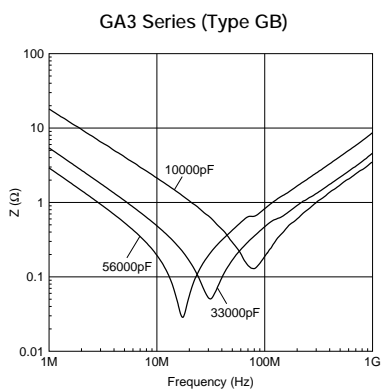

Capacitance - AC Voltage Characteristics

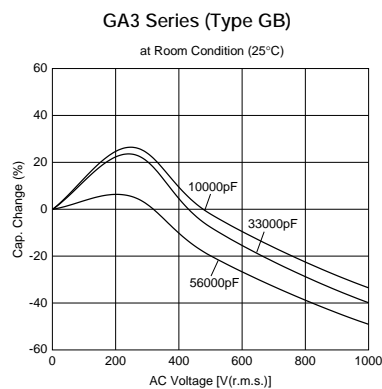
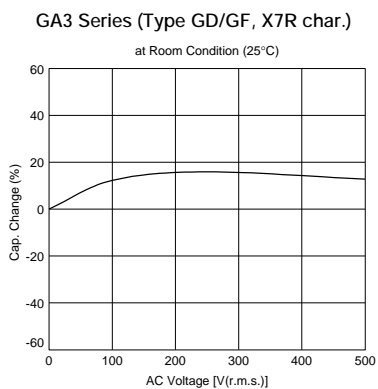

Package

Taping is standard packaging method.

■ Minimum Quantity Guide

Part Number		Dimensions (mm)			Quantity (pcs.)	
					ø180mm Reel	
		L	W	T	Paper Tape	Embossed Tape
Medium Voltage	GRM18	1.6	0.8	0.8	4,000	-
	GRM21	2.0	1.25	1.0	4,000	-
				1.25	-	3,000
	GRM31/GR731	3.2	1.6	1.0	4,000	-
				1.25	-	3,000
				1.6	-	2,000
	GRM32	3.2	2.5	1.0	4,000	-
				1.25	-	3,000
				1.5	-	2,000
				2.0	-	1,000
	GRM42/GR442	4.5	2.0	1.0	-	3,000
				1.5	-	2,000
2.0				-	2,000	
GRM43/GR443	4.5	3.2	1.5	-	1,000	
			2.0	-	1,000	
			2.5	-	500	
GRM55/GR455	5.7	5.0	2.0	-	1,000	
AC250V	GA242	4.5	2.0	1.5	-	2,000
	GA243	4.5	3.2	1.5	-	1,000
				2.0	-	1,000
GA255	5.7	5.0	2.0	-	1,000	
Safety Std. Certification	GA342	4.5	2.0	1.0	-	3,000
				1.5	-	2,000
				2.0	-	2,000
	GA343	4.5	3.2	1.5	-	1,000
				2.0	-	1,000
	GA352	5.7	2.8	1.5	-	1,000
	GA355	5.7	5.0	1.5	-	1,000
				2.0	-	1,000
				2.5	-	500
2.7				-	500	
			2.9	-	500	

■ Tape Carrier Packaging

(1) Appearance of Taping

① Embossed Tape

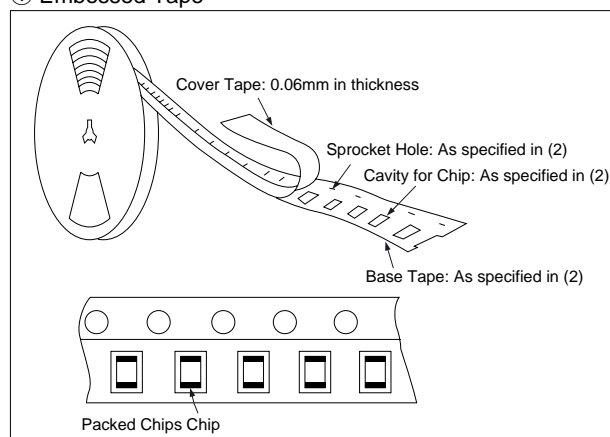

② Paper Tape

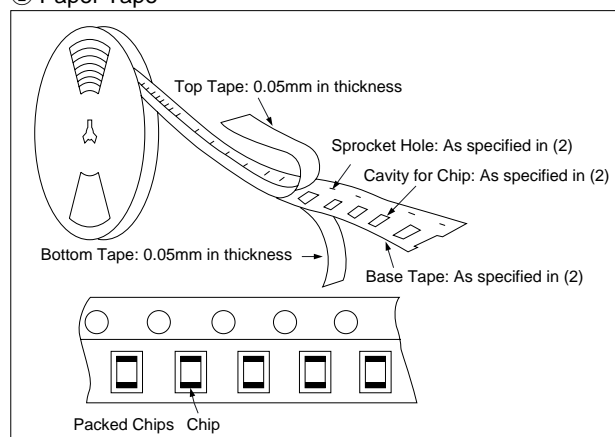

Continued on the following page.

Package

Continued from the preceding page.

(2) Dimensions of Tape

① Embossed Tape

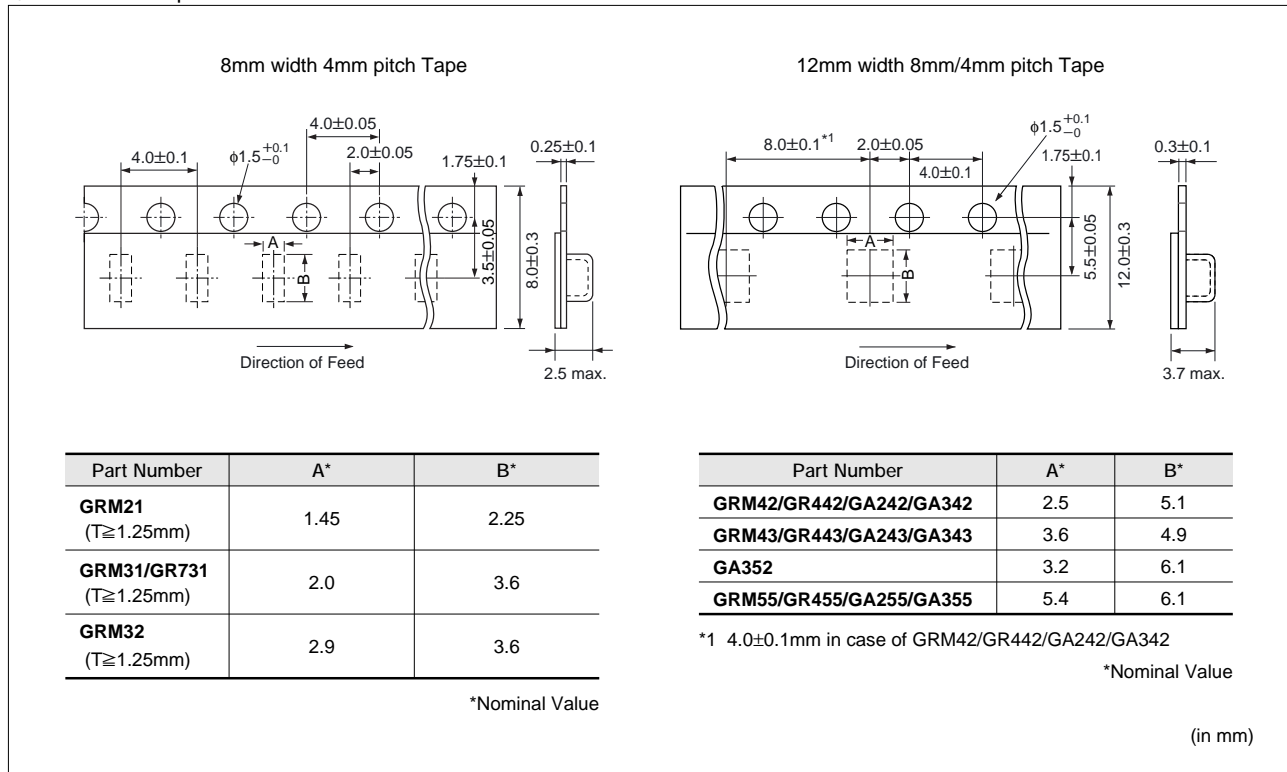

② Paper Tape

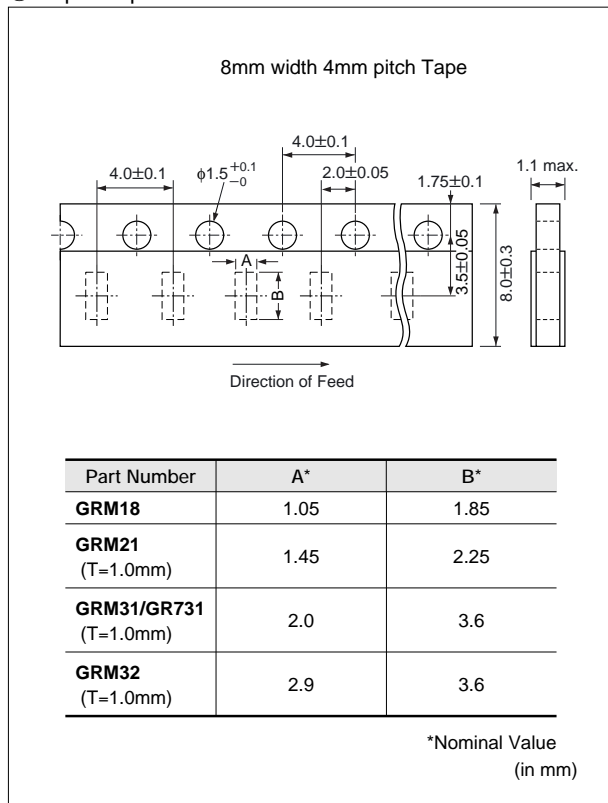

(3) Dimensions of Reel

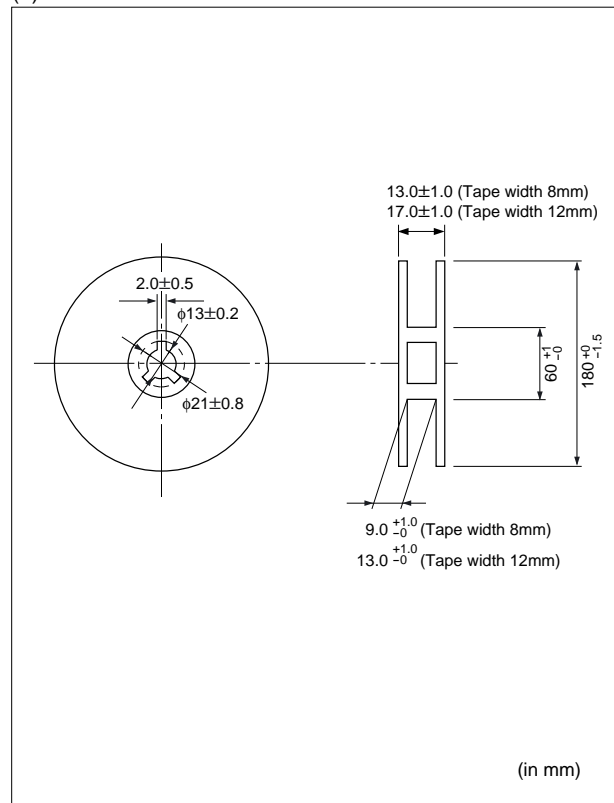

Continued on the following page.

Package

Continued from the preceding page.

(4) Taping Method

- ① Tapes for capacitors are wound clockwise. The sprocket holes are to the right as the tape is pulled toward the user.
- ② Part of the leader and part of the empty tape should be attached to the end of the tape as shown at right.
- ③ The top tape or cover tape and base tape are not attached at the end of the tape for a minimum of 5 pitches.
- ④ Missing capacitors number within 0.1% of the number per reel or 1 pc, whichever is greater, and are not continuous.
- ⑤ The top tape or cover tape and bottom tape should not protrude beyond the edges of the tape and should not cover sprocket holes.
- ⑥ Cumulative tolerance of sprocket holes, 10 pitches: $\pm 0.3\text{mm}$.
- ⑦ Peeling off force: 0.1 to 0.6N in the direction shown at right.

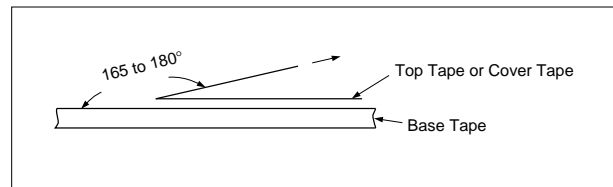
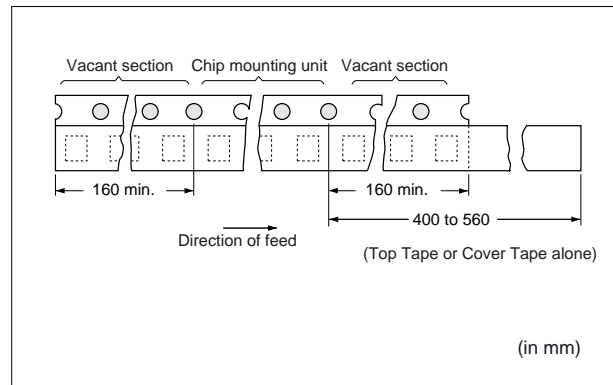

Caution

■ Storage and Operating Conditions

Operating and storage environment

Do not use or store capacitors in a corrosive atmosphere, especially where chloride gas, sulfide gas, acid, alkali, salt or the like are present. And avoid exposure to moisture. Before cleaning, bonding or molding this product, verify that these processes do not affect product quality by testing the performance of a cleaned, bonded or molded product in the intended equipment. Store the capacitors where the temperature and relative humidity do not exceed 5 to 40 degrees centigrade and 20 to 70%.

Use capacitors within 6 months after delivered.

Check the solderability after 6 months or more.

FAILURE TO FOLLOW THE ABOVE CAUTIONS MAY RESULT, WORST CASE, IN A SHORT CIRCUIT AND CAUSE FUMING OR PARTIAL DISPERSION WHEN THE PRODUCT IS USED.

■ Handling

1. Vibration and impact

Do not expose a capacitor to excessive shock or vibration during use.

2. Do not directly touch the chip capacitor, especially the ceramic body. Residue from hands/fingers may create a short circuit environment.

FAILURE TO FOLLOW THE ABOVE CAUTIONS MAY RESULT, WORST CASE, IN A SHORT CIRCUIT AND CAUSE FUMING OR PARTIAL DISPERSION WHEN THE PRODUCT IS USED.



■ Caution (Rating)

1. Operating Voltage

When DC-rated capacitors are to be used in AC or ripple current circuits, be sure to maintain the V_{p-p} value of the applied voltage or the V_{0-p} which contains DC bias within the rated voltage range.

When the voltage is applied to the circuit, starting or stopping may generate irregular voltage for a transit period because of resonance or switching. Be sure to use a capacitor with a rated voltage range that includes these irregular voltages.

When DC-rated capacitors are to be used in input circuits from commercial power source (AC filter), be sure to use Safety Certified Capacitors because various regulations on withstand voltage or impulse withstand established for each equipment should be taken into considerations.

Voltage	DC Voltage	DC+AC Voltage	AC Voltage	Pulse Voltage (1)	Pulse Voltage (2)
Positional Measurement					

2. Operating Temperature, Self-generated Heat, and Load Reduction at High-frequency Voltage Condition

Keep the surface temperature of a capacitor below the upper limit of its rated operating temperature range. Be sure to take into account the heat generated by the capacitor itself. When the capacitor is used in a high-frequency voltage, pulse voltage, it may self-generate heat due to dielectric loss.

(1) In case of X7R char.

Applied voltage should be the load such as self-generated heat is within 20°C on the condition of atmosphere temperature 25°C. When measuring, use a thermocouple of small thermal capacity -K of $\phi 0.1\text{mm}$ in conditions where the capacitor is not affected by radiant heat from other components or surrounding ambient fluctuations. Excessive heat may lead to deterioration of the capacitor's characteristics and reliability. (Never attempt to perform measurement with the cooling fan running. Otherwise, accurate measurement cannot be ensured.)

Continued on the following page.

⚠ Caution

Continued from the preceding page.

(2) In case of C0G, U2J char.

Due to the low self-heating characteristics of low-dissipation capacitors, the allowable electric power of these capacitors is generally much higher than that of X7R characteristic capacitors.

When a high frequency voltage which cause 20°C self heating to the capacitor is applied, it will exceed capacitor's allowable electric power.

The frequency of the applied sine wave voltage should be less than 500kHz (less than 100kHz in case of rated voltage: DC3.15kV). The applied voltage should be less than the value shown in figure below.

While, in case of non-sine wave which include a harmonic frequency, please contact our sales representatives or product engineers. Excessive heat may lead to deterioration of the capacitor's characteristics and reliability. (Never attempt to perform measurement with the cooling fan running. Otherwise, accurate measurement cannot be ensured.)

<C0G char., Rated Voltage: DC3.15kV>

The capacitors less than 22pF can be applied maximum 4.0kV peak to peak at 100kHz or less only for the ballast or the resonance usage in the LCD backlight inverter circuit.

<Capacitor Selection Tool>

We are also offering free software the "capacitor selection tool: Murata Medium Voltage Capacitors Selection Tool by Voltage Form (*)" which will assist you in selecting a suitable capacitor.

The software can be downloaded from Murata's Internet Website.

(http://www.murata.com/designlib/mmcsv_e.html).

By inputting capacitance values and applied voltage waveform of the specific capacitor series, this software will calculate the capacitor's power consumption and list suitable capacitors (non-sine wave is also available).

* Subject series are below.

· Temperature Characteristics C0G, U2J

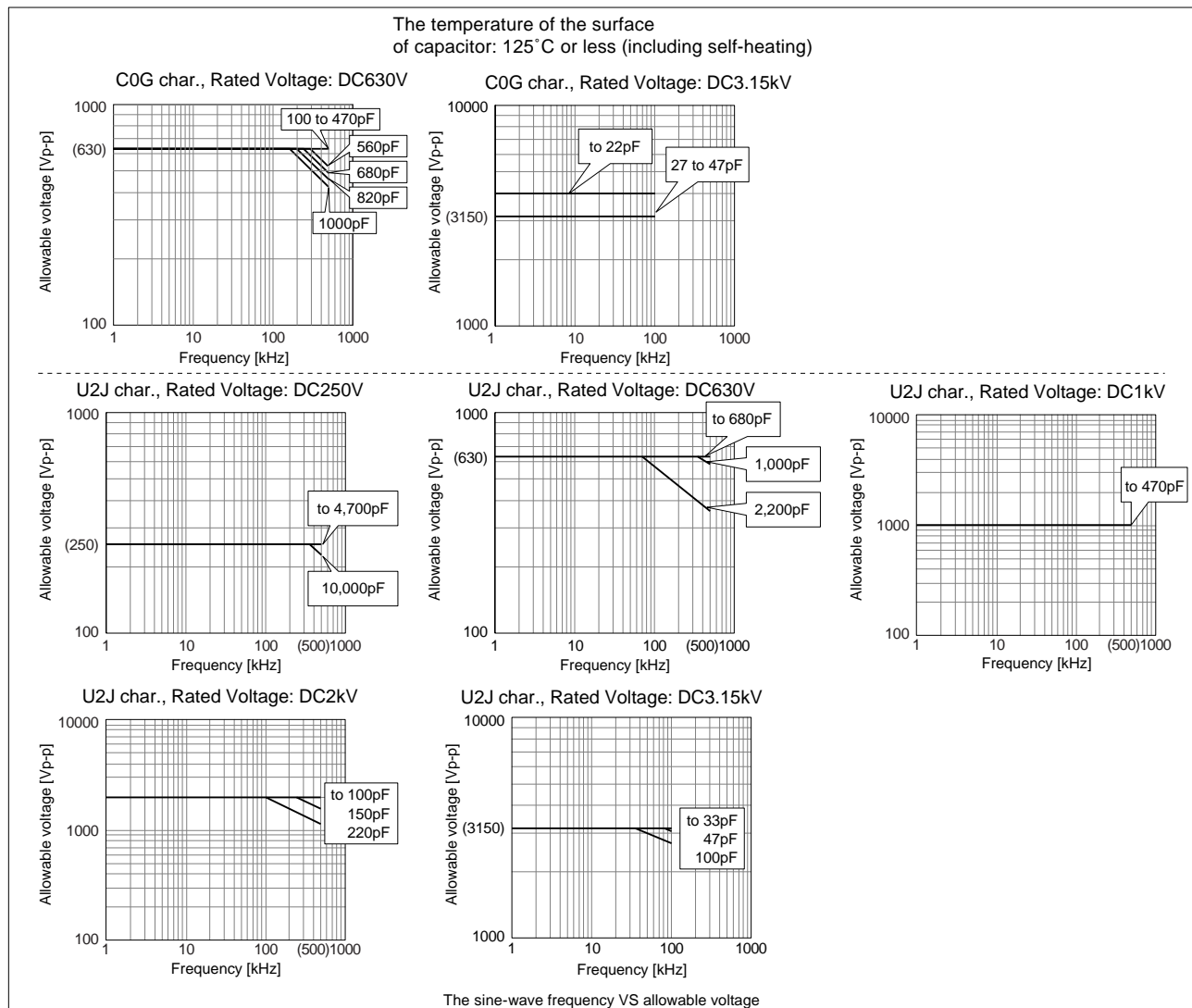

Continued on the following page. ↗

Caution

Continued from the preceding page.

3. Fail-safe

Failure of a capacitor may result in a short circuit. Be sure to provide an appropriate fail-safe function such as a fuse on your product to help eliminate possible electric shock, fire, or fumes.

Please consider using fuses on each AC line if the capacitors are used between the AC input lines and earth (line bypass capacitors), to prepare for the worst case, such as a short circuit.

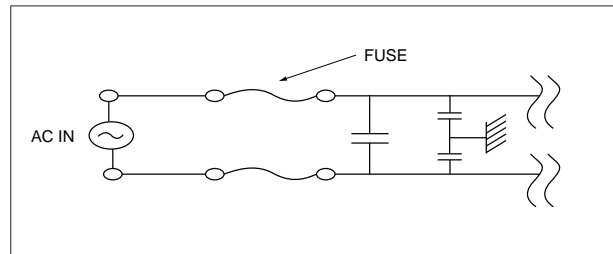

4. Test Condition for AC Withstanding Voltage

(1) Test Equipment

Tests for AC withstanding voltage should be made with equipment capable of creating a wave similar to a 50/60 Hz sine wave.

If the distorted sine wave or overload exceeding the specified voltage value is applied, a defect may be caused.

(2) Voltage Applied Method

The capacitor's leads or terminals should be firmly connected to the output of the withstanding voltage test equipment, and then the voltage should be raised from near zero to the test voltage. If the test voltage is applied directly to the capacitor without raising it from near zero, it should be applied with the zero cross*. At the end of the test time, the test voltage should be reduced to near zero, and then the capacitor's leads or terminals should be taken off the output of the withstanding voltage test equipment. If the test voltage is applied directly to the capacitor without raising it from near zero, surge voltage may occur and cause a defect.

*ZERO CROSS is the point where voltage sine wave pass 0V.

- See the figure at right -

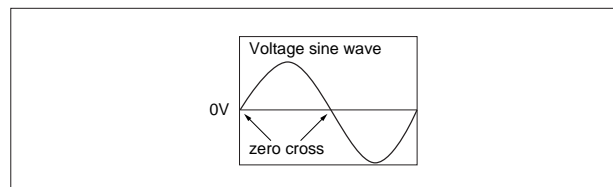

FAILURE TO FOLLOW THE ABOVE CAUTIONS MAY RESULT, WORST CASE, IN A SHORT CIRCUIT AND CAUSE FUMING OR PARTIAL DISPERSION WHEN THE PRODUCT IS USED.

⚠ Caution

■ Caution (Soldering and Mounting)

1. Vibration and Impact

Do not expose a capacitor to excessive shock or vibration during use.

2. Circuit Board Material

It is possible for the chip to crack by the expansion and shrinkage of a metal board.

Please contact us if you want to use our ceramic capacitors on a metal board such as Aluminum.

3. Land Layout for Cropping PC Board

Choose a mounting position that minimizes the stress imposed on the chip during flexing or bending of the board.

[Component Direction]

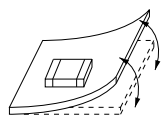

<Example to be avoided>

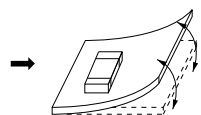

<Examples of improvements>

Locate chip horizontal to the direction in which stress acts.

[Chip Mounting Close to Board Separation Point]

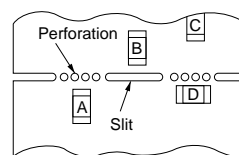

Chip arrangement
Worst A>C>B-D Best

Continued on the following page. ↗



Continued from the preceding page.

4. Reflow Soldering

- When sudden heat is given to the components, the mechanical strength of the components should go down because remarkable temperature change causes deformity of components inside. In order to prevent mechanical damage in the components, preheating should be required for both of the components and the PCB board. Preheating conditions are shown in Table 1. It is required to keep temperature differential between the soldering and the components surface (ΔT) as small as possible.
- Solderability of Tin plating termination chip might be deteriorated when low temperature soldering profile where peak solder temperature is below the Tin melting point is used. Please confirm the solderability of Tin plating termination chip before use.
- When components are immersed in solvent after mounting, be sure to maintain the temperature difference (ΔT) between the component and solvent within the range shown in the Table 1.

Table 1

Part Number	Temperature Differential
G□□18/21/31	$\Delta T \leq 190^\circ\text{C}$
G□□32/42/43/52/55	$\Delta T \leq 130^\circ\text{C}$

Recommended Conditions

	Pb-Sn Solder		Lead Free Solder
	Infrared Reflow	Vapor Reflow	
Peak Temperature	230-250°C	230-240°C	240-260°C
Atmosphere	Air	Air	Air or N ₂

Pb-Sn Solder: Sn-37Pb
 Lead Free Solder: Sn-3.0Ag-0.5Cu

Optimum Solder Amount for Reflow Soldering

- Overly thick application of solder paste results in excessive fillet height solder. This makes the chip more susceptible to mechanical and thermal stress on the board and may cause cracked chips.
- Too little solder paste results in a lack of adhesive strength on the outer electrode, which may result in chips breaking loose from the PCB.
- Make sure the solder has been applied smoothly to the end surface to a height of 0.2mm min.

Inverting the PCB

Make sure not to impose an abnormal mechanical shock on the PCB.

[Standard Conditions for Reflow Soldering]

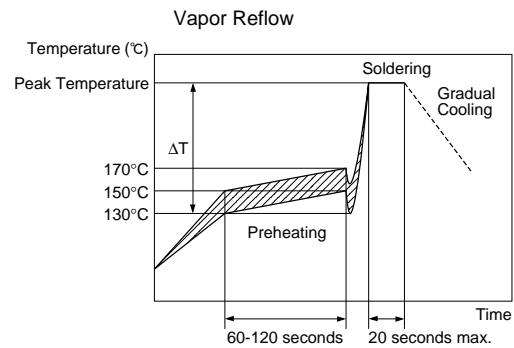
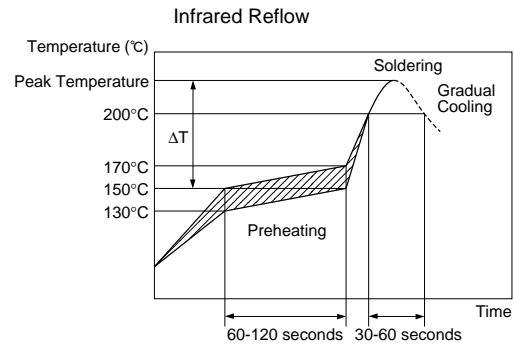

[Allowable Soldering Temperature and Time]

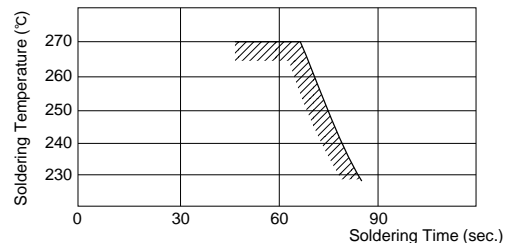

In case of repeated soldering, the accumulated soldering time must be within the range shown above.

[Optimum Solder Amount for Reflow Soldering]

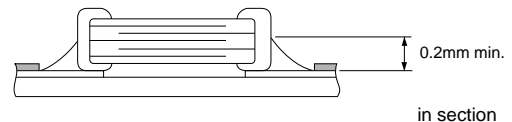

Continued on the following page. ↗

⚠ Caution

☞ Continued from the preceding page.

5. Flow Soldering

- When sudden heat is given to the components, the mechanical strength of the components should go down because remarkable temperature change causes deformity of components inside. And an excessively long soldering time or high soldering temperature results in leaching by the outer electrodes, causing poor adhesion or a reduction in capacitance value due to loss of contact between electrodes and end termination.
- In order to prevent mechanical damage in the components, preheating should be required for both of the components and the PCB board. Preheating conditions are shown in Table 2. It is required to keep temperature differential between the soldering and the components surface (ΔT) as small as possible.
- When components are immersed in solvent after mounting, be sure to maintain the temperature difference between the component and solvent within the range shown in Table 2.
Do not apply flow soldering to chips not listed in Table 2.

Table 2

Part Number	Temperature Differential
G□□18/21/31	$\Delta T \leq 150^\circ\text{C}$

Recommended Conditions

	Pb-Sn Solder	Lead Free Solder
Peak Temperature	240-250°C	250-260°C
Atmosphere	Air	N ₂

Pb-Sn Solder: Sn-37Pb

Lead Free Solder: Sn-3.0Ag-0.5Cu

- Optimum Solder Amount for Flow Soldering
The top of the solder fillet should be lower than the thickness of components. If the solder amount is excessively big, the risk of cracking is higher during board bending or under any other stressful conditions.

[Standard Conditions for Flow Soldering]

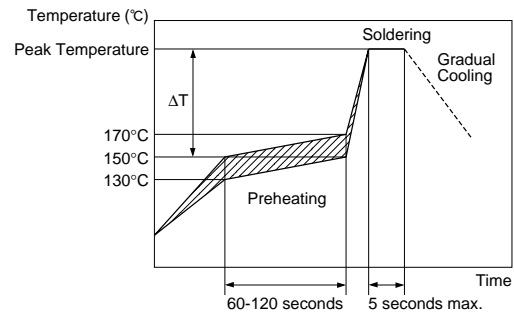

[Allowable Soldering Temperature and Time]

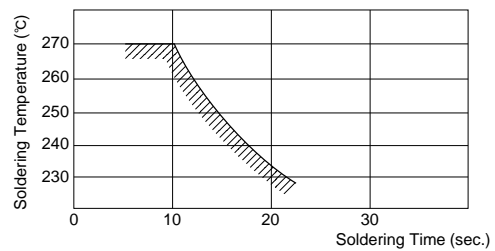

In case of repeated soldering, the accumulated soldering time must be within the range shown above.

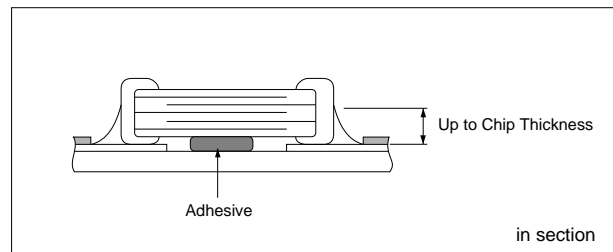

Continued on the following page. ☞

Caution

Continued from the preceding page.

6. Correction with a Soldering Iron

- When sudden heat is applied to the components by use of a soldering iron, the mechanical strength of the components will go down because the extreme temperature change causes deformations inside the components.

In order to prevent mechanical damage to the components, preheating is required for both the components and the PCB board.

Preheating conditions, (The "Temperature of the Soldering Iron Tip", "Preheating Temperature", "Temperature Differential" between iron tip and the

components and the PCB), should be within the conditions of table 3.

It is required to keep the temperature differential between the soldering Iron and the components surface (ΔT) as small as possible.

After soldering, do not allow the component/PCB to cool down rapidly.

The operating time for the re-working should be as short as possible. When re-working time is too long, it may cause solder leaching, and that will cause a reduction of the adhesive strength of the terminations.

Table 3

Part Number	Temperature of Soldering Iron tip	Preheating Temperature	Temperature Differential (ΔT)	Atmosphere
G□□18/21/31	350°C max.	150°C min.	$\Delta T \leq 190^\circ\text{C}$	air
G□□32/42/43/52/55	280°C max.	150°C min.	$\Delta T \leq 130^\circ\text{C}$	air

*Applicable for both Pb-Sn and Lead Free Solder.

Pb-Sn Solder: Sn-37Pb

Lead Free Solder: Sn-3.0Ag-0.5Cu

- Optimum Solder Amount when re-working Using a Soldering Iron

In case of smaller sizes than G□□18, the top of the solder fillet should be lower than 2/3's of the thickness of the component or 0.5mm whichever is smaller.

In case of larger sizes than G□□21, the top of the solder fillet should be lower than 2/3's of the thickness of the component.

If the solder amount is excessive, the risk of cracking is higher during board bending or under any other stressful conditions.

A Soldering iron $\phi 3\text{mm}$ or smaller should be used.

It is also necessary to keep the soldering iron from touching the components during the re-work.

Solder wire with $\phi 0.5\text{mm}$ or smaller is required for soldering.

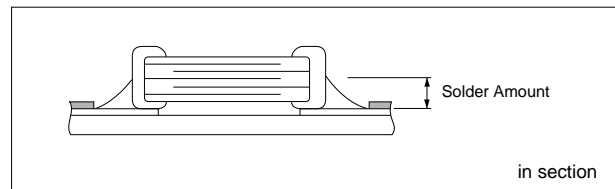

7. Washing

Excessive output of ultrasonic oscillation during cleaning causes PCBs to resonate, resulting in cracked chips or broken solder. Take note not to vibrate PCBs.

FAILURE TO FOLLOW THE ABOVE CAUTIONS MAY RESULT, WORST CASE, IN A SHORT CIRCUIT AND FUMING WHEN THE PRODUCT IS USED.

Notice

■ Notice (Soldering and Mounting)

1. Construction of Board Pattern

After installing chips, if solder is excessively applied to the circuit board, mechanical stress will cause destruction resistance characteristics to lower. To prevent this, be extremely careful in determining shape and dimension before designing the circuit board diagram.

Construction and Dimensions of Pattern (Example)

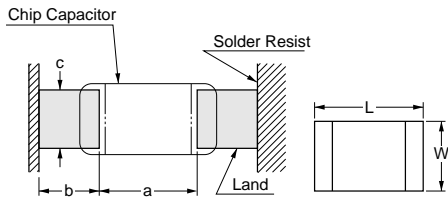

Flow Soldering

L×W	a	b	c
1.6×0.8	0.6-1.0	0.8-0.9	0.6-0.8
2.0×1.25	1.0-1.2	0.9-1.0	0.8-1.1
3.2×1.6	2.2-2.6	1.0-1.1	1.0-1.4

Flow soldering : 3.2×1.6 or less available.

Reflow Soldering

L×W	a	b	c
1.6×0.8	0.6-0.8	0.6-0.7	0.6-0.8
2.0×1.25	1.0-1.2	0.6-0.7	0.8-1.1
3.2×1.6	2.2-2.4	0.8-0.9	1.0-1.4
3.2×2.5	2.0-2.4	1.0-1.2	1.8-2.3
4.5×2.0	2.8-3.4	1.2-1.4	1.4-1.8
4.5×3.2	2.8-3.4	1.2-1.4	2.3-3.0
5.7×2.8	4.0-4.6	1.4-1.6	2.1-2.6
5.7×5.0	4.0-4.6	1.4-1.6	3.5-4.8

(in mm)

Dimensions of Slit (Example)

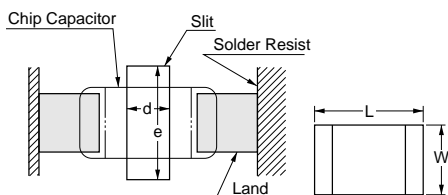

Preparing slit helps flux cleaning and resin coating on the back of the capacitor. But, the length of slit design should be shorter enough as much as possible to prevent the mechanical damage in the capacitor. The longer slit design might receive more severe mechanical stress from the PCB. Recommendable slit design is shown in the Table.

L×W	d	e
1.6×0.8	-	-
2.0×1.25	-	-
3.2×1.6	1.0-2.0	3.2-3.7
3.2×2.5	1.0-2.0	4.1-4.6
4.5×2.0	1.0-2.8	3.6-4.1
4.5×3.2	1.0-2.8	4.8-5.3
5.7×2.8	1.0-4.0	4.4-4.9
5.7×5.0	1.0-4.0	6.6-7.1

(in mm)

Continued on the following page.

Notice

Continued from the preceding page.

Land Layout to Prevent Excessive Solder

	Mounting Close to a Chassis	Mounting with Leaded Components	Mounting Leaded Components Later
Examples of Prohibition			
Examples of Improvements by the Land Division			

2. Mounting of Chips

- Thickness of adhesives applied
Keep thickness of adhesives applied (50-105 μ m or more) to reinforce the adhesive contact considering the thickness of the termination or capacitor (20-70 μ m) and the land pattern (30-35 μ m).
- Mechanical shock of the chip placer
When the positioning claws and pick-up nozzle are worn, the load is applied to the chip while positioning is concentrated in one position, thus causing cracks, breakage, faulty positioning accuracy, etc. Careful checking and maintenance are necessary to prevent unexpected trouble.
An excessively low bottom dead point of the suction nozzle imposes great force on the chip during mounting, causing cracked chips. Please set the suction nozzle's bottom dead point on the upper surface of the board.

3. Soldering

(1) Limit of losing effective area of the terminations and conditions needed for soldering.

Depending on the conditions of the soldering temperature and/or immersion (melting time), effective areas may be lost in some part of the terminations.

To prevent this, be careful in soldering so that any possible loss of the effective area on the terminations will securely remain at a maximum of 25% on all edge length A-B-C-D-A of part with A, B, C, D, shown in the Figure below.

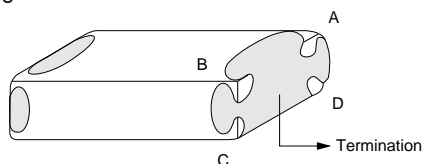

(2) Flux Application

- An excessive amount of flux generates a large quantity of flux gas, causing deteriorated solderability. So apply flux thinly and evenly throughout. (A foaming system is generally used for flow soldering.)
- Flux containing too high percentage of halide may cause corrosion of the outer electrodes unless sufficient cleaning. Use flux with a halide content of 0.2% max.
- Do not use strong acidic flux.
- Do not use water-soluble flux*.
(*Water-soluble flux can be defined as non rosin type flux including wash-type flux and non-wash-type flux.)

Continued on the following page. ↗

Notice

☒ Continued from the preceding page.

4. Cleaning

Please confirm there is no problem in the reliability of the product beforehand when cleaning it with the intended equipment.

The residue after cleaning it might cause the decrease in the surface resistance of the chip and the corrosion of the electrode part, etc. As a result it might cause reliability to deteriorate. Please confirm beforehand that there is no problem with the intended equipment in ultrasonic cleansing.

5. Resin Coating

Please use it after confirming there is no influence on the product with a intended equipment beforehand when the resin coating and molding.

A cracked chip might be caused at the cooling/heating cycle by the amount of resin spreading and/or bias thickness.

The resin for coating and molding must be selected as the stress is small when stiffening and the hygroscopic is low as possible.

■ Rating

1. Capacitance change of capacitor

(1) In case of X7R char.

Capacitors have an aging characteristic, whereby the capacitor continually decreases its capacitance slightly if the capacitor is left on for a long time. Moreover, capacitance might change greatly depending on the surrounding temperature or an applied voltage. So, it is not likely to be suitable for use in a time constant circuit.

Please contact us if you need detailed information.

(2) In case of any char. except X7R

Capacitance might change a little depending on the surrounding temperature or an applied voltage.

Please contact us if you intend to use this product in a strict time constant circuit.

2. Performance check by equipment

Before using a capacitor, check that there is no problem in the equipment's performance and the specifications.

Generally speaking, CLASS 2 (X7R char.) ceramic capacitors have voltage dependence characteristics and temperature dependence characteristics in capacitance. So, the capacitance value may change depending on the operating condition in the equipment. Therefore, be sure to confirm the apparatus performance of receiving influence in a capacitance value change of a capacitor, such as leakage current and noise suppression characteristics.

Moreover, check the surge-proof ability of a capacitor in the equipment, if needed, because the surge voltage may exceed specific value by the inductance of the circuit.

ISO 9001 Certifications

■ Qualified Standards

The products listed here have been produced by ISO 9001 certified factory.

Plant
Fukui Murata Mfg. Co., Ltd.
Izumo Murata Mfg. Co., Ltd.
Okayama Murata Mfg. Co., Ltd.
Murata Electronics Singapore (Pte.) Ltd.
Beijing Murata Electronics Co., Ltd.
Wuxi Murata Electronics Co., Ltd.

△Note:

1. Export Control

<For customers outside Japan>

No Murata products should be used or sold, through any channels, for use in the design, development, production, utilization, maintenance or operation of, or otherwise contribution to (1) any weapons (Weapons of Mass Destruction [nuclear, chemical or biological weapons or missiles] or conventional weapons) or (2) goods or systems specially designed or intended for military end-use or utilization by military end-users.

<For customers in Japan>

For products which are controlled items subject to the "Foreign Exchange and Foreign Trade Law" of Japan, the export license specified by the law is required for export.

2. Please contact our sales representatives or product engineers before using the products in this catalog for the applications listed below, which require especially high reliability for the prevention of defects which might directly damage a third party's life, body or property, or when one of our products is intended for use in applications other than those specified in this catalog.

- | | |
|-----------------------------|--|
| ① Aircraft equipment | ② Aerospace equipment |
| ③ Undersea equipment | ④ Power plant equipment |
| ⑤ Medical equipment | ⑥ Transportation equipment (vehicles, trains, ships, etc.) |
| ⑦ Traffic signal equipment | ⑧ Disaster prevention / crime prevention equipment |
| ⑨ Data-processing equipment | ⑩ Application of similar complexity and/or reliability requirements to the applications listed above |

3. Product specifications in this catalog are as of Jul 2009. They are subject to change or our products in it may be discontinued without advance notice. Please check with our sales representatives or product engineers before ordering. If there are any questions, please contact our sales representatives or product engineers.

4. Please read rating and △ CAUTION (for storage, operating, rating, soldering, mounting and handling) in this catalog to prevent smoking and/or burning, etc.

5. This catalog has only typical specifications because there is no space for detailed specifications. Therefore, please approve our product specifications or transact the approval sheet for product specifications before ordering.

6. Please note that unless otherwise specified, we shall assume no responsibility whatsoever for any conflict or dispute that may occur in connection with the effect of our and/or a third party's intellectual property rights and other related rights in consideration of your use of our products and/or information described or contained in our catalogs. In this connection, no representation shall be made to the effect that any third parties are authorized to use the rights mentioned above under licenses without our consent.

7. No ozone depleting substances (ODS) under the Montreal Protocol are used in our manufacturing process.



Murata Manufacturing Co., Ltd.

<http://www.murata.com/>

Head Office

1-10-1, Higashi Kotari, Nagaokakyo-shi, Kyoto 617-8555, Japan
Phone: 81-75-951-9111

International Division

3-29-12, Shibuya, Shibuya-ku, Tokyo 150-0002, Japan
Phone: 81-3-5469-6123 Fax: 81-3-5469-6155 E-mail: intl@murata.co.jp