

### Anti-Surge Thick Film Chip Resistors 0805, 1206, 1210

Type: **ERJ P06, P08, P14**



#### ■ Features

- Characteristic : Better the Anti-Surge characteristic than the metal film resistor
- High reliability  
Metal glaze thick film resistive element and three layers of electrodes result in high reliability
- Solderability  
Suitable for both reflow soldering and flow soldering
- High power... 0.25 W : 2012(0805) size  
0.33 W : 3216(1206) size  
0.5 W : 3225(1210) size  
Thick film resistor with excellent Anti-Pulse characteristic and high rated power
- Reference Standards... IEC 60115-8, JIS C 5201-8

#### ■ Explanation of Part Numbers

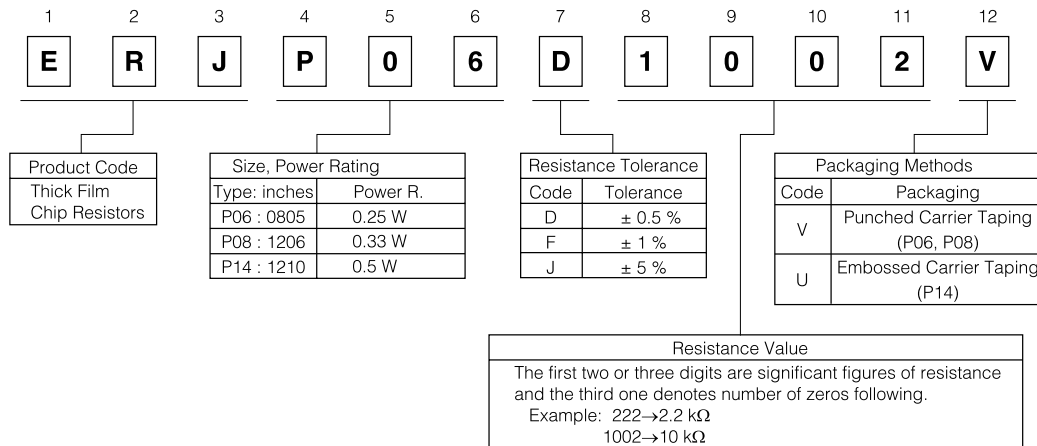

### Construction

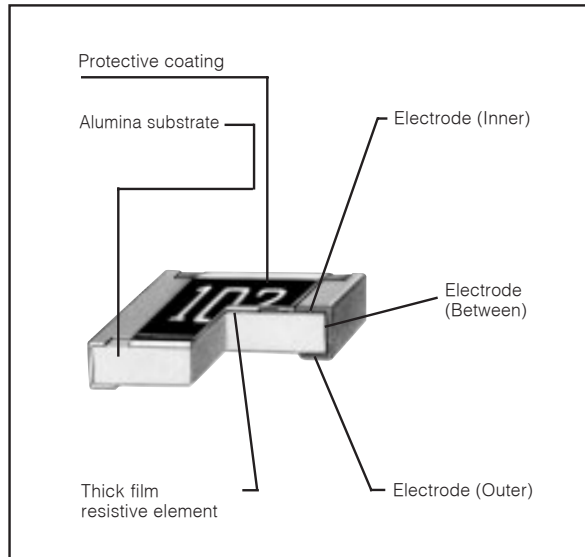

### Dimensions in mm (not to scale)

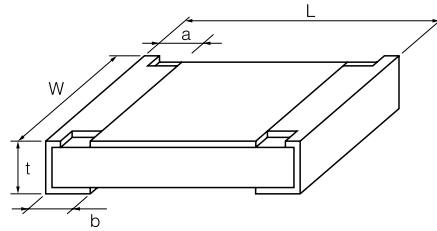

Type (inches)	Dimensions (mm)					Mass (Weight) [g/1000 pcs.]
	L	W	a	b	t	
ERJP06 (0805)	2.00 $\pm$ 0.20	1.25 $\pm$ 0.10	0.25 $\pm$ 0.20	0.40 $\pm$ 0.20	0.60 $\pm$ 0.10	4
ERJP08 (1206)	3.20 $\pm$ 0.25	1.60 $\pm$ 0.15	0.40 $\pm$ 0.20	0.50 $\pm$ 0.20	0.60 $\pm$ 0.10	10
ERJP14 (1210)	3.20 $\pm$ 0.20	2.50 $\pm$ 0.20	0.35 $\pm$ 0.20	0.50 $\pm$ 0.20	0.60 $\pm$ 0.10	16

### Ratings

Type (inches)	Power Rating at 70 °C (W)	Limiting Element Voltage (Maximum RCWV) <sup>(1)</sup> (V)	Maximum Overload Voltage <sup>(2)</sup> (V)	Resistance Tolerance(%)	Resistance Range (Ω)	T.C.R. [ $\times 10^{-6}/^{\circ}\text{C}$ (ppm/ $^{\circ}\text{C}$ )]	Category Temperature Range (Operating Temperature Range) ( $^{\circ}\text{C}$ )
ERJP06 (0805)	0.25	150	200	$\pm 0.5, \pm 1$	10 to 1M (E24, E96)	Less than 33 Ω : $\pm 300$ More than 33 Ω : $\pm 100$	-55 to +155
				$\pm 5$	10 to 1M (E24)	Less than 33 Ω : $\pm 300$ More than 33 Ω : $\pm 200$	
ERJP08 (1206)	0.33	200	400	$\pm 0.5, \pm 1$	10 to 1M (E24, E96)	$\pm 100$	-55 to +155
				$\pm 5$	10 to 1M (E24)	$\pm 200$	
ERJP14 (1210)	0.5	200	400	$\pm 0.5, \pm 1$	10 to 1M (E24, E96)	$\pm 100$	-55 to +155
				$\pm 5$	1 to 1M (E24)	Less than 10 Ω : -100 to +600 More than 10 Ω : $\pm 200$	

(1) Rated Continuous Working Voltage (RCWV) shall be determined from  $\text{RCWV} = \sqrt{\text{Power Rating} \times \text{Resistance Values}}$ , or Limiting Element Voltage (max. RCWV) listed above, whichever less.

(2) Overload (Short-time Overload) Test Voltage (SOTV) shall be determined from  $\text{SOTV} = 2.5 \times \text{Power Rating}$  or max. Overload Voltage listed above whichever less.

### Power Derating Curve

For resistors operated in ambient temperatures above 70 °C, power rating shall be derated in accordance with the right figure.

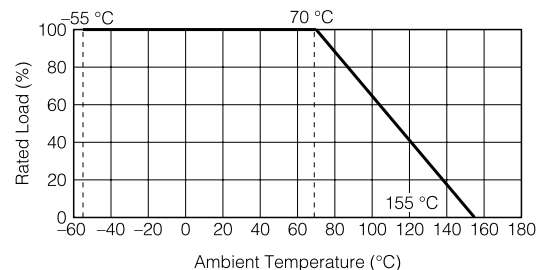

### ■ Packaging Methods (Taping)

#### ● Standard Quantity

Type	Kind of Taping	Pitch (P <sub>1</sub> )	Quantity
ERJP06	Punched Carrier Taping	4 mm	5000 pcs./reel
ERJP08			
ERJP14	Embossed Carrier Taping		

#### ● Carrier Tape

(Unit : mm)

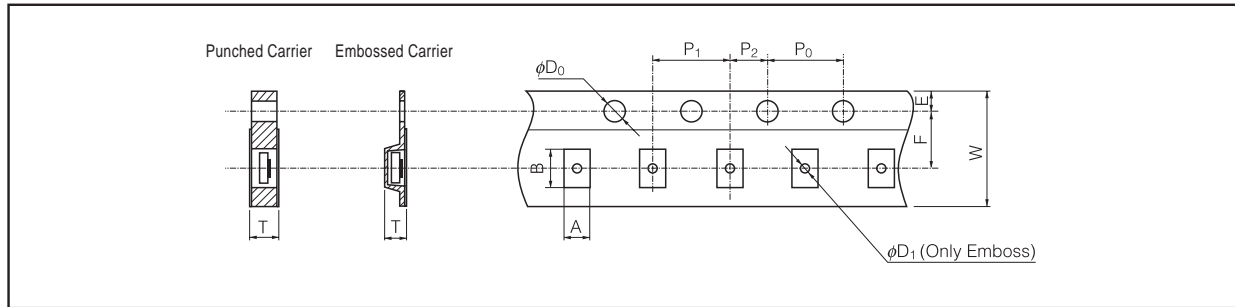

Type	A	B	W	F	E	P <sub>1</sub>	P <sub>2</sub>	P <sub>0</sub>	φD <sub>0</sub>	T	φD <sub>1</sub>
ERJP06	1.65 <sup>+0.15</sup>	2.50 <sup>+0.20</sup>	8.00 <sup>+0.20</sup>	3.50 <sup>+0.05</sup>	1.75 <sup>+0.10</sup>	4.00 <sup>+0.10</sup>	2.00 <sup>+0.05</sup>	4.00 <sup>+0.10</sup>	1.50 <sup>+0.1</sup>	0.84 <sup>+0.05</sup>	-
ERJP08	2.00 <sup>+0.15</sup>	3.60 <sup>+0.20</sup>									-
ERJP14	2.80 <sup>+0.20</sup>	3.50 <sup>+0.20</sup>	8.00 <sup>+0.30</sup>							1.00 <sup>+0.10</sup>	1.0 <sup>+0.10</sup>

#### ● Taping Reel

(Unit : mm)

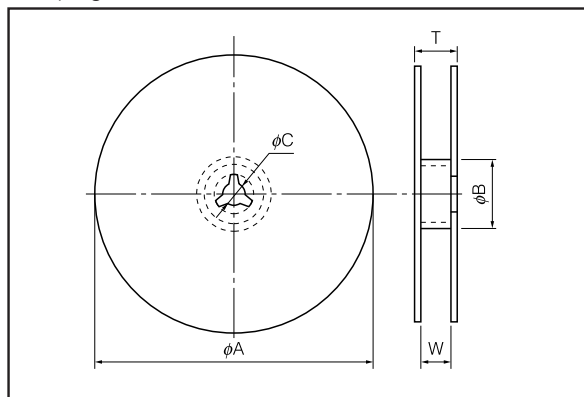

Type	φA	φB	φC	W	T
ERJP06	180.0 <sup>+3.0</sup> <sub>-3.0</sub>	60 min.	13.0 <sup>+1.0</sup>	9.0 <sup>+1.0</sup>	11.4 <sup>+1.0</sup>
ERJP08					
ERJP14					

### ■ Recommended Land Pattern

In the case of flow soldering, the land width must be smaller than the Chip Resistor width to control the solder amount properly. Generally, the land width should be 0.7 to 0.8 times (W) of the width of chip resistor. In the case of reflow soldering, solder amount can be adjusted, therefore the land width should be set to 1.0 to 1.3 times chip resistor width (W).

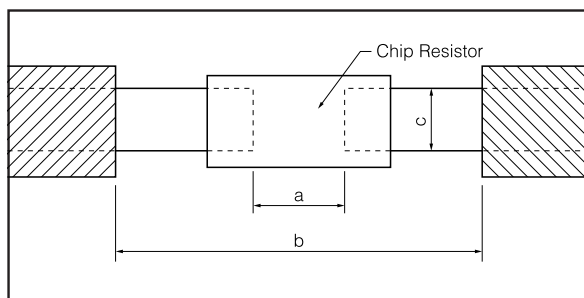

Type (inches)	Dimensions (mm)		
	a	b	c
ERJP06 (0805)	1 to 1.4	3.2 to 3.8	0.9 to 1.4
ERJP08 (1206)	2 to 2.4	4.4 to 5	1.2 to 1.8
ERJP14 (1210)	2 to 2.4	4.4 to 5	1.8 to 2.8

Design and specifications are each subject to change without notice. Ask factory for the current technical specifications before purchase and/or use. Should a safety concern arise regarding this product, please be sure to contact us immediately.

### ■ Recommended Soldering Conditions

Recommendations and precautions are described below.

#### ● Recommended soldering conditions for reflow

- Reflow soldering shall be two times maximum.
- Please contact us for additional information when you use in conditions other than those specified.
- Please measure a temperature of terminations and study solderability every kind of solder and board, before actual use.

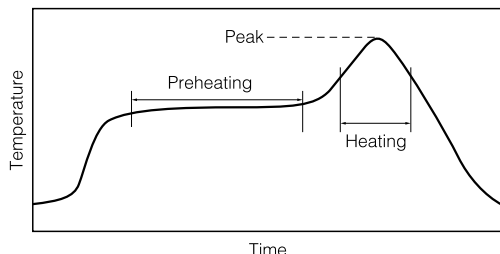

For solder (Example : Sn/Pb)

	Temperature	Time
Preheating	140 °C to 160 °C	60 s to 120 s
Main heating	Above 200 °C	30 s to 40 s
Peak	235 ± 5 °C	max. 10 s

For lead-free solder (Example : Sn/Ag/Cu)

	Temperature	Time
Preheating	150 °C to 180 °C	60 s to 120 s
Main heating	Above 230 °C	30 s to 40 s
Peak	max. 260 °C	max. 10 s

#### ● Recommended soldering conditions for flow

	For solder		For lead-free solder	
	Temperature	Time	Temperature	Time
Preheating	140 °C to 160 °C	60 s to 120 s	150 °C to 180 °C	60 s to 120 s
Soldering	245±5 °C	20 s to 30 s	max. 260 °C	max. 10 s

### ⚠ Cautions for Safety

The following are precautions for individual products. Please also refer to the precautions common to Fixed Resistors shown on page ER3 of this catalog.

1. Take measures against mechanical stress during and after mounting of Anti-Surge Thick Film Chip Resistors (hereafter called the Resistors) so as not to damage their electrodes and protective coatings.
2. If a transient load (heavy load in a short time) like a pulse is expected to be applied, check and evaluate the operations of the Resistors when installed in your products before use.  
Never exceed the rated power. Otherwise, the performance and/or reliability of the Resistors may be impaired.
3. Do not use halogen-based or other high-activity flux. Otherwise, the residue may impair the Resistors' performance and/or reliability.
4. When soldering with a soldering iron, never touch the Resistors' bodies with the tip of the soldering iron. When using a soldering iron with a high temperature tip, finish the soldering as quickly as possible (within three seconds at 350 °C max.).
5. As the amount of applied solder becomes larger, the mechanical stress applied to the Resistors increases, causing problems such as cracks and faulty characteristics. Avoid applying an excessive amount of solder.
6. Do not apply a shock to the Resistors or pinch them with a hard tool (e.g. pliers and tweezers). Otherwise, the Resistors' protective coatings and bodies may be chipped, affecting their performance.
7. Avoid excessive bend of printed circuit boards in order to protect the Resistors from abnormal stress.

## ⚠ Caution for Safety

### (Common precautions for Fixed Resistors)

- When using our products, no matter what sort of equipment they might be used for, be sure to make a written agreement on the specifications with us in advance. The design and specifications in this catalog are subject to change without prior notice.
- Do not use the products beyond the specifications described in this catalog.
- This catalog explains the quality and performance of the products as individual components. Before use, check and evaluate their operations when installed in your products.
- Install the following systems for a failsafe design to ensure safety if these products are to be used in equipment where a defect in these products may cause the loss of human life or other significant damage, such as damage to vehicles (automobile, train, vessel), traffic lights, medical equipment, aerospace equipment, electric heating appliances, combustion/gas equipment, rotating equipment, and disaster/crime prevention equipment.
  - \* Systems equipped with a protection circuit and a protection device
  - \* Systems equipped with a redundant circuit or other system to prevent an unsafe status in the event of a single fault

### (1) Precautions for use

- These products are designed and manufactured for general purpose and standard use in general electronic equipment (e.g. AV equipment, home electric appliances, office equipment, information and communication equipment)
- These products are not intended for use in the following special conditions. Before using the products, carefully check the effects on their quality and performance, and determine whether or not they can be used.
  1. In liquid, such as water, oil, chemicals, or organic solvent
  2. In direct sunlight, outdoors, or in dust
  3. In salty air or air with a high concentration of corrosive gas, such as Cl<sub>2</sub>, H<sub>2</sub>S, NH<sub>3</sub>, SO<sub>2</sub>, or NO<sub>2</sub>
  4. In an environment where strong static electricity or electromagnetic waves exist
  5. In an environment where these products cause dew condensation
  6. Sealing or coating of these products or a printed circuit board on which these products are mounted, with resin or other materials
- These products generate Joule heat when energized. Carefully position these products so that their heat will not affect the other components.
- Carefully position these products so that their temperatures will not exceed the category temperature range due to the effects of neighboring heat-generating components. Do not mount or place heat-generating components or inflammables, such as vinyl-coated wires, near these products .
- Note that non-cleaning solder, halogen-based highly active flux, or water-soluble flux may deteriorate the performance or reliability of the products.
- Carefully select a flux cleaning agent for use after soldering. An unsuitable agent may deteriorate the performance or reliability. In particular, when using water or a water-soluble cleaning agent, be careful not to leave water residues. Otherwise, the insulation performance may be deteriorated.

### (2) Precautions for storage

The performance of these products, including the solderability, is guaranteed for a year from the date of arrival at your company, provided that they remain packed as they were when delivered and stored at a temperature of 5 °C to 35 °C and a relative humidity of 45 % to 85 %.

Even within the above guarantee periods, do not store these products in the following conditions. Otherwise, their electrical performance and/or solderability may be deteriorated, and the packaging materials (e.g. taping materials) may be deformed or deteriorated, resulting in mounting failures.

1. In salty air or in air with a high concentration of corrosive gas, such as Cl<sub>2</sub>, H<sub>2</sub>S, NH<sub>3</sub>, SO<sub>2</sub>, or NO<sub>2</sub>
2. In direct sunlight

### <Package markings>

Package markings include the product number, quantity, and country of origin. In principle, the country of origin should be indicated in English.