

10 9 8 7 6 5 4 3 2 1

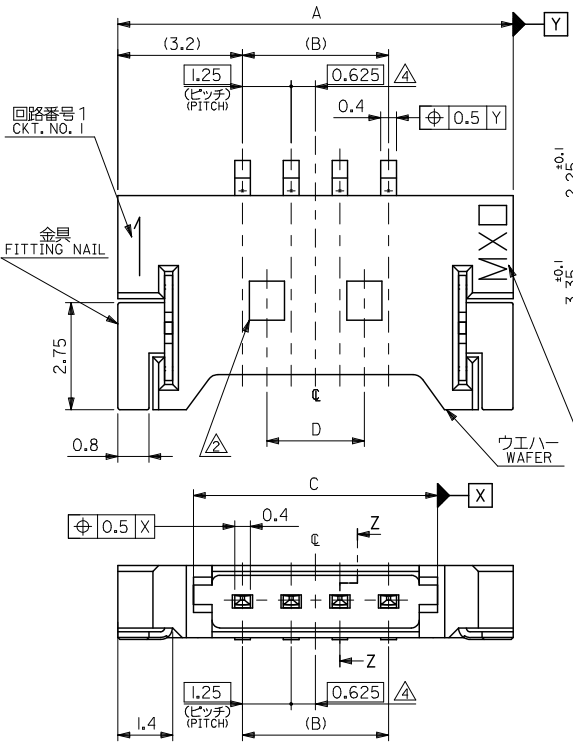

参考基板レイアウト  
RECOMMENDED P.C. BOARD PATTERN DIM. (REF.)

注記 NOTES

- 嵌合相手: 51146 シリーズ  
MATES WITH : 51146 SERIES
- ロック窓は2、3極品は1箇所、4極品以上は2箇所とする。  
LOCKING WINDOW : ONE PLACE FOR 2 AND 3 CIRCUIT PRODUCTS AND TWO PLACES FOR MORE THAN 3 CIRCUIT PRODUCTS.
- 基準面[V]からのソルダーテールと金具の半田付け面のズレ量は、上方向に0.05MAX、下方向0.15MAX、とし、20極以下の相互のパラッキ量は0.IMAXとする。  
MISALIGNMENT OF SOLDER TAIL AND FITTING NAIL FROM [V]  
: UPPER DIRECTION 0.05MAX.  
: LOWER DIRECTION 0.15MAX.  
: OFFSET BETWEEN UPPER AND LOWER 0.IMAX. (UNDER 20 CKTS.)
- 偶数極の製品に適用。  
APPLY EVEN CIRCUIT PRODUCTS.
- 材質 MATERIAL  
ウェハー WAFER : PPS, UL94V-0  
ピン: リン青銅 FIN: PHOSPHOR BRONZE  
コンタクト部: 金メッキ 0.2 マイクロメートル以上  
CONTACT AREA: GOLD 0.2 MICROMETER MINIMUM  
テール部: 錫メッキ 3.0 マイクロメートル以上  
TAIL AREA: TIN 3.0 MICROMETER MINIMUM  
下地メッキ: ニッケルメッキ 1.0 マイクロメートル以上  
UNDER PLATING: NICKEL 1.0 MICROMETER MINIMUM  
金具: リン青銅 FITTING NAIL: PHOSPHOR BRONZE  
錫メッキ 3.0 マイクロメートル以上  
TIN 3.0 MICROMETER MINIMUM  
下地メッキ: ニッケルメッキ 1.0 マイクロメートル以上  
UNDER PLATING: NICKEL 1.0 MICROMETER MINIMUM
- 本製品は 53780-\*\*-\*\*10/-\*\*-\*\*18 の鉛フリー品である。  
THIS PRODUCT IS LEAD FREE OF 53780-\*\*-\*\*10/-\*\*-\*\*18.
- ELV及びRoHS適合品  
ELV & RoHS COMPLIANT.

16.25	22.5	38.77	36.25	42.65	53780-3070	30
8.75	22.5	26.27	23.75	30.15		-2070 20
7.5	20	23.77	21.25	27.65		-1870 18
6.25	16.25	20.02	17.5	23.9		-1570 15
5	15	18.77	16.25	22.65		-1470 14
3.75	12.5	16.27	13.75	20.15		-1270 12
2.5	10	13.77	11.25	17.65		-1070 10
2.5	8.75	12.52	10	16.4		-0970 9
1.25	7.5	11.27	8.75	15.15		-0870 8
1.25	6.25	10.02	7.5	13.9		-0770 7
--	5	8.77	6.25	12.65		-0670 6
--	3.75	7.52	5	11.4		-0570 5
--	2.5	6.27	3.75	10.15		-0470 4
--	--	5.02	2.5	8.9		-0370 3
--	--	3.77	1.25	7.65		53780-0270 2
E	D	C	B	A	EMBOSSED PACKAGE	CKT.
					オーダー番号 ORDER No.	極数

CONNECTOR SERIES NO. 53780-\*\*-\*\*19

REVISED EC NO: J2010-0021 DRAWN BY: AKASAKI CHKD BY: HAYASHI APPR: NIKITA 2009/07/07 2009/07/08 2009/07/08	GENERAL TOLERANCES (UNLESS SPECIFIED)		DIMENSION STYLE MM ONLY		SCALE ---	DESIGN UNITS METRIC	THIRD ANGLE PROJECTION
	10 UNDER	±0.2	DRAWN BY T. UENO	DATE '04/04/15	TITLE 1.25 W/B CONN WAFER ASSY FOR SMT		
	10 OVER 30 UNDER	±0.25	CHECKED BY M. SASAO	DATE '04/04/15	MOLEX INCORPORATED		
	30 OVER	±0.3	APPROVED BY M. SASAO	DATE '04/04/15	MATERIAL NO. SEE CHART	DOCUMENT NO. SD-53780-003	SHEET NO. 1 OF 2
	ANGULAR ±3°	DRAFT WHERE APPLICABLE MUST REMAIN WITHIN DIMENSIONS					

10 9 8 7 6 5 4 3 2 1

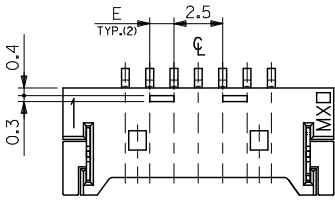

7~19 極の奇数極に適用  
APPLY FOR ODD CIRCUITS OF 7~19

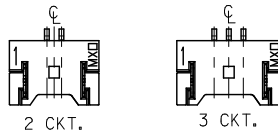

ロック形状図  
LOCK CONFIGURATION

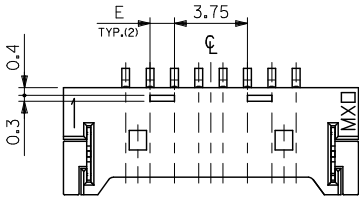

8~30 極の偶数極に適用  
APPLY FOR EVEN CIRCUITS OF 8~30

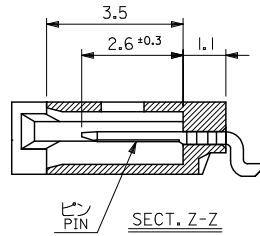

CONNECTOR SERIES NO. 53780-\*\*\*19

REVISED EC NO: J2010-0021 DRAWN: TAKASAKI 2009/07/07 CHKD: HAYASHI 2009/07/08 APPR: NIKITA 2009/07/08	GENERAL TOLERANCES (UNLESS SPECIFIED)		DIMENSION STYLE MM ONLY		SCALE ---	DESIGN UNITS METRIC	THIRD ANGLE PROJECTION
	10 UNDER	±0.2	DRAWN BY T. UENO	DATE '04/04/15	TITLE 1.25 W/B CONN WAFER ASSY FOR SMT		
	10 OVER 30 UNDER	±0.25	CHECKED BY M. SASAO	DATE '04/04/15	MOLEX INCORPORATED		
	30 OVER	±0.3	APPROVED BY M. SASAO	DATE '04/04/15	MATERIAL NO. SEE CHART	DOCUMENT NO. SD-53780-003	SHEET NO. 2 OF 2
	ANGULAR ±3 °		THIS DRAWING CONTAINS INFORMATION THAT IS PROPRIETARY TO MOLEX INCORPORATED AND SHOULD NOT BE USED WITHOUT WRITTEN PERMISSION				
	DRAFT WHERE APPLICABLE MUST REMAIN WITHIN DIMENSIONS						

10 9 8 7 6 5 4 3 2 1

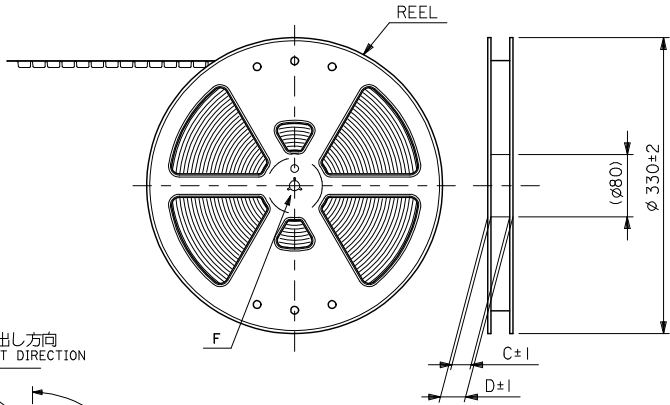
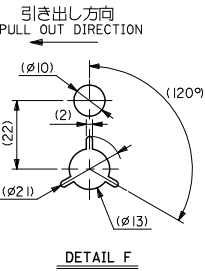

**NOTES**

1. 梱包数量：1500個/リール  
NUMBER OF CONNECTORS : 1500PCS/REEL
2. リードテープ長さ LEAD TAPE LENGTH

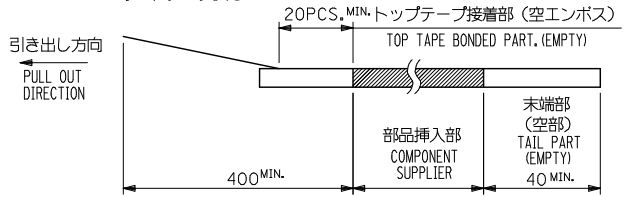

3. トップテープの剥離強度：0.1N ~ 1.3N (10gf ~ 130gf)  
(剥離方向は下図参照)  
尚、本規格値は出荷時に適用。(但し、輸送時に剥離が発生しないこと。)  
PEELING OFF FORCE OF TOP TAPE : 0.1N ~ 1.3N (10gf ~ 130gf)  
(PEELING DIRECTION AS SHOWN IN FOLLOWING FIG.)  
THIS REQUIREMENT SHOULD BE APPLIED AT SHIPMENT.  
PEEL OFF SHOULD NOT BE ALLOWED, DURING TRANSPORTATION.

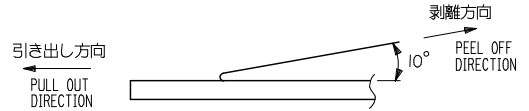

4. 材料 (MATERIAL)  
キャリアテープ (CARRIER TAPE) : ポリプロピレン (POLYPROPYLENE)  
トップテープ (TOP TAPE) : PET, PE, PEF  
リール (REEL) : ポリスチレン (PS) <リサイクル材を含む>  
POLYSTYRENE (PS) <RECYCLE MATERIAL CONTAINED>
5. 本製品は 53780-\*\*-90/-\*\*-80 の鉛フリー品である。  
THIS PRODUCT IS LEAD FREE OF 53780-\*\*-90/-\*\*-80.
6. ELV及びRoHS適合品  
ELV & RoHS COMPLIANT

MODEL NO. 53780-\*\*-70

REVISED EC NO: J2010-0021 DRAWN: TAKASAKI 2009/07/07 CHKD: HAYASHI 2009/07/08 APPR: NIKITA 2009/07/08	GENERAL TOLERANCES (UNLESS SPECIFIED)		DIMENSION STYLE MM ONLY		SCALE ---	DESIGN UNITS METRIC	THIRD ANGLE PROJECTION
	10 UNDER	±0.2	DRAWN BY T. UENO	DATE '04/04/15	TITLE 1.25 W/B WAFER ASSY EMBOSSSED TAPE PACKAGE		
	10 OVER 30 UNDER	±0.25	CHECKED BY M. SASAO	DATE '04/04/15	MOLEX INCORPORATED		
	30 OVER	±0.3	APPROVED BY M. SASAO	DATE '04/04/15	MATERIAL NO. SEE CHART	DOCUMENT NO. SD-53780-004	SHEET NO. 1 OF 3
ANGULAR ±3°		DRAFT WHERE APPLICABLE MUST REMAIN WITHIN DIMENSIONS		THIS DRAWING CONTAINS INFORMATION THAT IS PROPRIETARY TO MOLEX INCORPORATED AND SHOULD NOT BE USED WITHOUT WRITTEN PERMISSION			

10 9 8 7 6 5 4 3 2 1

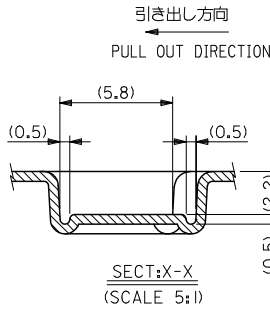
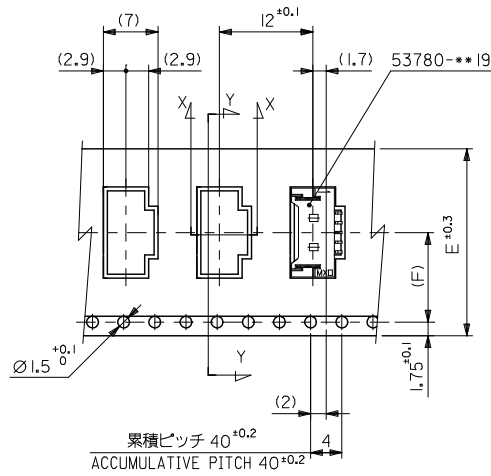
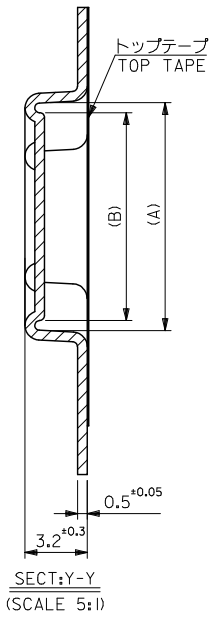

11.5	24	29.4	25.4	11.75	16.7	53780-0970	9
				10.5	15.45	53780-0870	8
				9.25	14.2	53780-0770	7
				8	12.95	53780-0670	6
				6.75	11.7	53780-0570	5
7.5	16	21.4	17.4	5.5	10.45	53780-0470	4
				4.25	9.2	53780-0370	3
(F)	E	D	C	(B)	(A)	MATERIAL NO.	搬入 CKT.

MODEL NO.		53780-**70	
SCALE		---	
DESIGN UNITS		METRIC	
THIRD ANGLE PROJECTION			
DRAWN BY		DATE	
T. UENO		'04/04/15	
CHECKED BY		DATE	
M. SASAO		'04/04/15	
APPROVED BY		DATE	
M. SASAO		'04/04/15	
MATERIAL NO.		SEE CHART	
DOCUMENT NO.		SD-53780-004	
SHEET NO.		2 OF 3	

TITLE: 1.25 W/B WAFER ASSY EMBOSSED TAPE PACKAGE

MOLEX INCORPORATED

THIS DRAWING CONTAINS INFORMATION THAT IS PROPRIETARY TO MOLEX INCORPORATED AND SHOULD NOT BE USED WITHOUT WRITTEN PERMISSION

REVISED	EC NO: J2010-0021	2009/07/07	GENERAL TOLERANCES (UNLESS SPECIFIED)
	DRW: HTAKASAKI	2009/07/08	10 UNDER ±0.2
	CHK: DMHAYASHI	2009/07/08	10 OVER 30 UNDER ±0.25
	APP: RNIKITA	2009/07/08	30 OVER ±0.3
DESCRIPTION	ANGULAR ±3°		
REV	DRAFT WHERE APPLICABLE MUST REMAIN WITHIN DIMENSIONS		

10 9 8 7 6 5 4 3 2 1

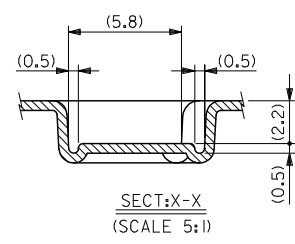
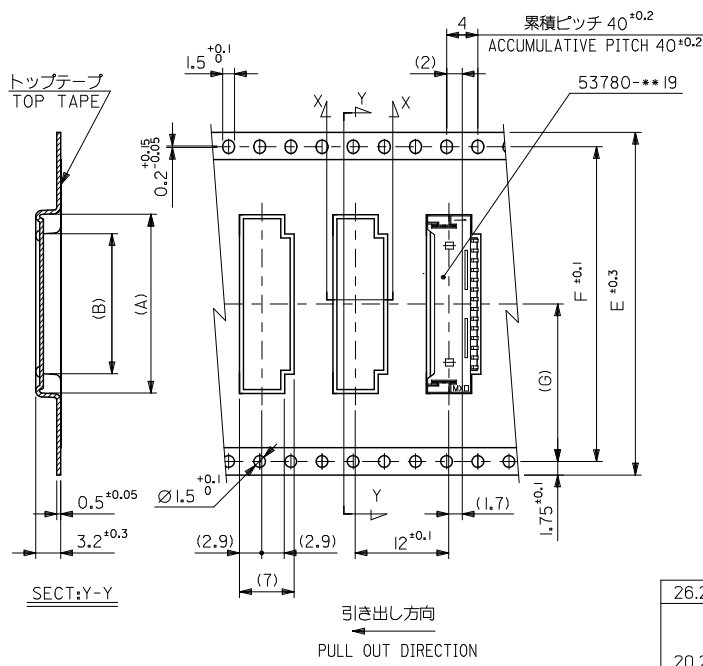

26.2	52.4	56	61.4	57.4	38	42.95	53780-3070	30
					25.5	30.45	53780-2070	20
					25.5	27.95	53780-1870	18
					19.25	24.2	53780-1570	15
					18	22.95	53780-1470	14
					15.5	20.45	53780-1270	12
					14.2	28.4	53780-1070	10
(G)	F	E キャリアテープ幅 CARRIER TAPE WIDTH	D	C	(B)	(A)	MATERIAL NO.	数量 QTY.

REVISED E.C. NO: J2010-0021 DRAWN: AKASAKI 2009/07/07 CHYKOHAYASHI 2009/07/08 APPR: NIKITA 2009/07/08	GENERAL TOLERANCES (UNLESS SPECIFIED)		DIMENSION STYLE MM ONLY		SCALE ---	DESIGN UNITS METRIC	MODEL NO. 53780-***70
	10 UNDER	±0.2	DRAWN BY T. UENO	DATE '04/04/15	TITLE 1.25 W/B WAFER ASSY EMBOSSED TAPE PACKAGE		
	10 OVER 30 UNDER	±0.25	CHECKED BY M. SASAO	DATE '04/04/15	THIRD ANGLE PROJECTION		
	30 OVER	±0.3	APPROVED BY M. SASAO	DATE '04/04/15	MOLEX INCORPORATED		
	ANGULAR ±3°	MATERIAL NO. SEE CHART		DOCUMENT NO. SD-53780-004	SHEET NO. 3 OF 3		
	DRAFT WHERE APPLICABLE MUST REMAIN WITHIN DIMENSIONS	THIS DRAWING CONTAINS INFORMATION THAT IS PROPRIETARY TO MOLEX INCORPORATED AND SHOULD NOT BE USED WITHOUT WRITTEN PERMISSION					