

## Aluminum Capacitors Solid Al, Radial Pearl Miniature

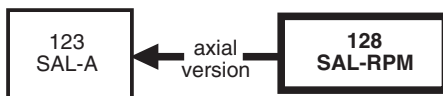

Fig. 1

QUICK REFERENCE DATA	
DESCRIPTION	VALUE
Maximum case sizes (H x W x T in mm)	10 x 7 x 3.5 to 10 x 8 x 6
Rated capacitance range (E6 series), $C_R$	0.22 $\mu$ F to 68 $\mu$ F
Tolerance on $C_R$	$\pm 20\%$
Rated voltage range, $U_R$	6.3 V to 40 V
Category temperature range: $U_R = 6.3$ V to 40 V $U_C = 6.3$ V to 25 V	- 55 °C to + 85 °C - 55 °C to + 125 °C
Endurance test at 125 °C	10 000 h
Useful life at 125 °C	20 000 h
Useful life at 175 °C	2000 h
Useful life at 40 °C, $I_R$ applied	> 300 000 h
Shelf life at 0 V, 125 °C	500 h
Based on sectional specification	IEC 60384-4/EN 130300
Climatic category IEC 60068	55/125/56

### FEATURES

- Polarized aluminum electrolytic capacitors, solid electrolyte  $MnO_2$
- Radial leads, max. height 10 mm, resin dipped, orange colored
- Extremely long useful life, 20 000 h/125 °C
- Extended high temperature range up to 175 °C
- Excellent low temperature, impedance and ESR behaviour
- Charge and discharge proof, application with 0  $\Omega$  resistance allowed
- Reverse DC voltage up to 0.3 x  $U_R$  allowed
- AC voltage up to 0.8 x  $U_R$  allowed
- Compliant to RoHS Directive 2002/95/EC

**RoHS**  
COMPLIANT

### APPLICATIONS

- Audio-video, automotive, industrial high temperature and telecommunication
- Smoothing, filtering and buffering
- For small power supplies, DC/DC converters

### MARKING

The capacitors are marked (where possible) with the following information:

- Rated capacitance (in  $\mu$ F)
- Tolerance on rated capacitance, code letter in accordance with IEC 60062 (M for  $\pm 20\%$ )
- Rated voltage (in V) and category voltage if applicable
- Date code in accordance with IEC 60062
- Name of manufacturer
- “I” sign to indicate the negative terminal
- “+” sign to identify the positive terminal
- Series number

### MOUNTING

When bending, cutting or straightening the leads, ensure that the capacitor body is relieved of stress.

Bending after soldering must be avoided.

Completely sealing the component's body or use in an oxygen-free environment has a negative impact on useful life.

<b>SELECTION CHART FOR C<sub>R</sub>, U<sub>R</sub>, U<sub>C</sub>, AND RELEVANT MAXIMUM CASE SIZES (H x W x T in mm)</b>					
C <sub>R</sub> (μF)	U <sub>R</sub> (V) AT T <sub>amb</sub> = 85 °C				
	6.3	10	16	25	40
	U <sub>C</sub> (V) AT T <sub>amb</sub> = 125 °C				
	6.3	10	16	25	25
0.22	-	-	-	-	10 x 7 x 3.5
0.33	-	-	-	-	10 x 7 x 4
0.47	-	-	-	-	10 x 7 x 5
0.68	-	-	-	10 x 7 x 3.5	10 x 7 x 5
1.0	-	-	-	10 x 7 x 3.5	10 x 7 x 5
1.5	-	-	-	10 x 7 x 3.5	10 x 8 x 6
2.2	-	-	10 x 7 x 3.5	10 x 7 x 4	10 x 8 x 6
3.3	-	-	10 x 7 x 3.5	10 x 7 x 5	-
4.7	-	10 x 7 x 3.5	10 x 7 x 4	10 x 8 x 5	-
6.8	-	10 x 7 x 3.5	10 x 7 x 4	10 x 8 x 5	-
10	10 x 7 x 3.5	10 x 7 x 4	10 x 7 x 5	10 x 8 x 6	-
15	-	10 x 7 x 4	10 x 8 x 5	-	-
22	10 x 7 x 4	10 x 7 x 5	10 x 8 x 6	-	-
33	10 x 7 x 5	10 x 8 x 5	-	-	-
47	10 x 8 x 5	10 x 8 x 6	-	-	-
68	10 x 8 x 6	-	-	-	-

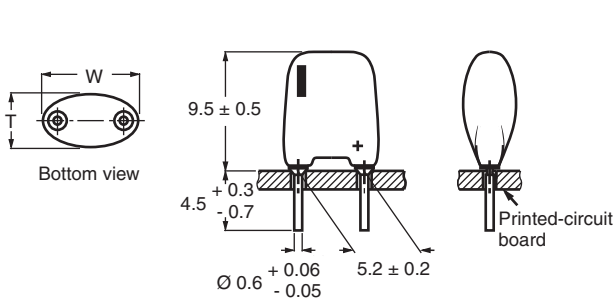
**DIMENSIONS in millimeters AND AVAILABLE FORMS**

The diameter of the mounting holes in the printed-circuit board is  $0.8 \pm 0.1$  mm.  
Flanges are provided with degassing grooves.

Fig. 2 - Form CB: Short leads, in boxes

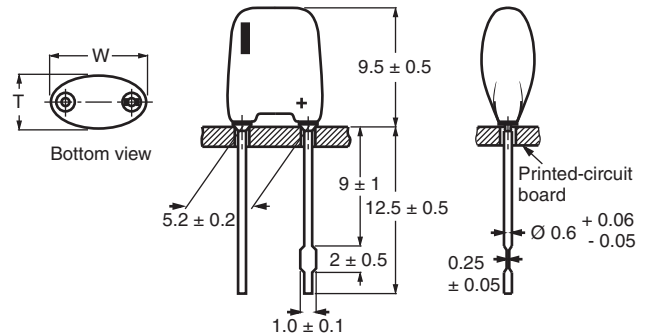

The diameter of the mounting holes in the printed-circuit board is  $0.8 \pm 0.1$  mm, except for the hole of the anode lead of Form CA capacitors:  $1.3 - 0.2$  mm.  
Flanges are provided with degassing grooves.

Fig. 3 - Form CA: Long leads with keyed polarity, in boxes

**Table 1**

<b>DIMENSIONS in millimeters, MASS AND PACKAGING QUANTITIES</b>						
MAXIMUM CASE SIZE H x W x T (mm)	CASE CODE	MASS (g)	PACKAGING QUANTITIES			
			FORM CA <sup>(1)</sup>	FORM CB <sup>(1)</sup>	FORM TR+	FORM TFA
10 x 7 x 3.5	20	≈ 0.25	1000	1000	2000	1000
10 x 7 x 4	30	≈ 0.30	1000	1000	2000	1000
10 x 7 x 5	40	≈ 0.35	1000	1000	1000	1000
10 x 8 x 5	50	≈ 0.50	1000	1000	1000	1000
10 x 8 x 6	60	≈ 0.60	1000	1000	1000	1000

**Notes**

- <sup>(1)</sup> In plastic bags of 200 units each  
 • Detailed tape dimensions see section "PACKAGING"

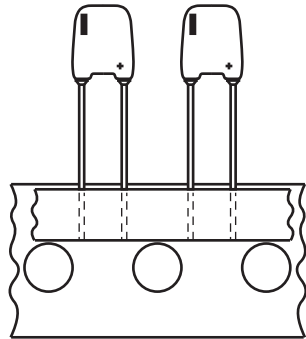
**TAPED PRODUCTS**

Form TR+: Taped on reel, positive leading  
Form TFA: Taped in ammpack

Fig. 4 - Taped versions

**ELECTRICAL DATA**

SYMBOL	DESCRIPTION
$C_R$	Rated capacitance at 100 Hz, tolerance $\pm 20\%$
$I_R$	Max. RMS ripple current no necessary DC applied
$I_{L5}$	Max. leakage current after 5 min at $U_R$
$\tan \delta$	Max. dissipation factor at 100 Hz
ESR	Max./typ. equivalent series resistance at 100 Hz
Z	Max. impedance at 100 kHz

**Note**

- Unless otherwise specified, all electrical values in Table 2 apply at  $T_{amb} = 20^\circ\text{C}$  to  $25^\circ\text{C}$ ,  $P = 86\text{ kPa}$  to  $106\text{ kPa}$ ,  $RH = 45\%$  to  $75\%$ .

**ORDERING EXAMPLE**

Maximum case size: 10 mm x 7 mm x 5 mm; Form CB

 Electrolytic capacitors 128 series 10  $\mu\text{F}/16\text{ V}$ ;  $\pm 20\%$ 

Ordering code: MAL2 128 55109 E3

Former 12NC: 2281 128 55109

Table 2

ELECTRICAL DATA AND ORDERING INFORMATION														
$U_C$ (V)	$U_R$ (V)	$C_R$ 100 Hz ( $\mu\text{F}$ )	MAXIMUM CASE SIZE H x W x T (mm)	$I_R$ 100 Hz 125 °C (mA)	$I_R$ 10 kHz 85 °C (mA)	$I_R$ 100 kHz 40 °C (mA)	$I_{L5}$ 5 min ( $\mu\text{A}$ )	MAX. ESR 100 Hz ( $\Omega$ )	TYP. ESR 100 Hz ( $\Omega$ )	Z 100 kHz ( $\Omega$ )	ORDERING CODE MAL2128.....			
											FORM CB	FORM CA	FORM TR+ REEL	FORM TFA AMMO
6.3	6.3	10	10 x 7 x 3.5	22.4	320	595	2	20	8	2.0	53109E3	73109E3	23109E3	33109E3
		22	10 x 7 x 4	32.9	470	870	4	9	3.5	1.0	53229E3	73229E3	23229E3	33229E3
		33	10 x 7 x 5	65.4	595	1100	5	6.1	2	0.70	53339E3	73339E3	23339E3	33339E3
		47	10 x 8 x 5	118.4	740	1360	7	4.3	2	0.50	53479E3	73479E3	23479E3	33479E3
		68	10 x 8 x 6	153.0	800	1650	11	3.0	1.5	0.40	53689E3	73689E3	23689E3	33689E3
10	10	4.7	10 x 7 x 3.5	16.1	230	425	2	43	16	3.00	54478E3	74478E3	24478E3	34478E3
		6.8	10 x 7 x 3.5	18.9	270	500	2	30	12	2.20	54688E3	74688E3	24688E3	34688E3
		10	10 x 7 x 4	21.7	310	573	3	20	9	1.70	54109E3	74109E3	24109E3	34109E3
		15	10 x 7 x 4	27.3	390	720	4	14	7	1.20	54159E3	74159E3	24159E3	34159E3
		22	10 x 7 x 5	51.7	470	870	6	9	3.5	0.90	54229E3	74229E3	24229E3	34229E3
		33	10 x 8 x 5	81.6	510	940	8	6.1	2	0.60	54339E3	74339E3	24339E3	34339E3
16	16	4.7	10 x 8 x 6	105.4	620	1140	12	4.3	1.5	0.40	54479E3	74479E3	24479E3	34479E3
		2.2	10 x 7 x 3.5	14.0	200	370	2	91	25	4.50	55228E3	75228E3	25228E3	35228E3
		3.3	10 x 7 x 3.5	16.1	230	425	2	61	26	3.30	55338E3	75338E3	25338E3	35338E3
		4.7	10 x 7 x 4	18.9	270	500	2	43	14	2.30	55478E3	75478E3	25478E3	35478E3
		6.8	10 x 7 x 4	22.4	320	590	3	30	11	1.65	55688E3	75688E3	25688E3	35688E3
		10	10 x 7 x 5	42.9	390	720	4	20	6	1.10	55109E3	75109E3	25109E3	35109E3
25	25	15	10 x 8 x 5	71.2	445	820	6	14	5	0.85	55159E3	75159E3	25159E3	35159E3
		22	10 x 8 x 6	86.7	510	940	9	9	3.5	0.65	55229E3	75229E3	25229E3	35229E3
		0.68	10 x 7 x 3.5	7.7	110	200	2	295	85	17.00	56687E3	76687E3	26687E3	36687E3
		1.0	10 x 7 x 3.5	9.1	130	240	2	200	71	12.50	56108E3	76108E3	26108E3	36108E3
		1.5	10 x 7 x 3.5	10.8	155	285	2	135	48	10.00	56158E3	76158E3	26158E3	36158E3
		2.2	10 x 7 x 4	13.6	195	360	2	91	34	7.00	56228E3	76228E3	26228E3	36228E3
25	40	3.3	10 x 7 x 5	16.1	230	425	2	61	19	5.20	56338E3	76338E3	26338E3	36338E3
		4.7	10 x 8 x 5	25.3	270	500	3	43	14	3.50	56478E3	76478E3	26478E3	36478E3
		6.8	10 x 8 x 6	52.7	310	570	4	30	11	2.70	56688E3	76688E3	26688E3	36688E3
		10	10 x 8 x 6	64.8	360	660	6	20	9	2.00	56109E3	76109E3	26109E3	36109E3
		0.22	10 x 7 x 3.5	4.2	60	115	2	910	275	27.00	57227E3	77227E3	27227E3	37227E3
		0.33	10 x 7 x 4	5.3	75	140	2	610	172	20.00	57337E3	77337E3	27337E3	37337E3
25	40	0.47	10 x 7 x 5	10.4	95	175	2	430	114	15.00	57477E3	77477E3	27477E3	37477E3
		0.68	10 x 7 x 5	12.1	110	205	2	295	89	10.00	57687E3	77687E3	27687E3	37687E3
		1.0	10 x 8 x 5	20.0	125	230	2	200	45	7.00	57108E3	77108E3	27108E3	37108E3
		1.5	10 x 8 x 6	25.5	150	280	2	135	35	5.50	57158E3	77158E3	27158E3	37158E3
		2.2	10 x 8 x 6	33.1	195	360	2	91	28	4.20	57228E3	77228E3	27228E3	37228E3

**Note**

- $\tan \delta$  at 100 Hz for all types  $< 0.10$

ADDITIONAL ELECTRICAL DATA		
PARAMETER	CONDITIONS	VALUE
<b>Voltage</b>		
Surge voltage		$U_s \leq 1.15 \times U_R$
Reverse voltage		$U_{rev} < 0.3 \times U_R$
Maximum peak AC voltage	Reverse voltage applied	$\leq 2 \text{ V}$
Maximum peak AC voltage, without reverse voltage applied	$T_{amb} \leq 85 \text{ }^\circ\text{C}$ : at $f \leq 0.1 \text{ Hz}$ at $0.1 \text{ Hz} < f \leq 1 \text{ Hz}$ at $1 \text{ Hz} < f \leq 10 \text{ Hz}$ at $10 \text{ Hz} < f \leq 50 \text{ Hz}$ at $f > 50 \text{ Hz}$	$0.30 \times U_R$ $0.45 \times U_R$ $0.60 \times U_R$ $0.65 \times U_R$ $0.80 \times U_R$
	$85 \text{ }^\circ\text{C} < T_{amb} \leq 125 \text{ }^\circ\text{C}$ : at $f \leq 0.1 \text{ Hz}$ at $0.1 \text{ Hz} < f \leq 1 \text{ Hz}$ at $1 \text{ Hz} < f \leq 10 \text{ Hz}$ at $10 \text{ Hz} < f \leq 50 \text{ Hz}$ at $f > 50 \text{ Hz}$	$0.15 \times U_R$ $0.22 \times U_R$ $0.30 \times U_R$ $0.32 \times U_R$ $0.40 \times U_R$
<b>Inductance</b>		
Equivalent series inductance (ESL)	Case sizes 10 mm x 7 mm x 3.5 mm to 10 mm x 7 mm x 5 mm	typ. 9 nH to 14 nH
	Case sizes 10 mm x 8 mm x 5 mm and 10 mm x 8 mm x 6 mm	typ. 11 nH to 16 nH
	All case sizes	max. 20 nH
<b>Dissipation</b>		
Maximum power dissipation	Case sizes 10 mm x 7 mm x 3.5 mm to 10 mm x 7 mm x 5 mm	$P_{125} = 88 \text{ mW}$
	Case sizes 10 mm x 8 mm x 5 mm and 10 mm x 8 mm x 6 mm	$P_{125} = 104 \text{ mW}$
<b>Current</b>		
Maximum leakage current	After 5 min at $U_R$ and $T_{amb} = 25 \text{ }^\circ\text{C}$	$I_{L5} \leq 0.025 C_R \times U_R$ or $2 \text{ } \mu\text{A}$ whichever is greater; see Table 2
Typical leakage current	15 s at $U_R$ and $T_{amb} = 25 \text{ }^\circ\text{C}$ : $U_R = 6.3 \text{ V to } 16 \text{ V}$	$\approx 0.2 \times$ value stated in Table 2
	$U_R = 25 \text{ V to } 40 \text{ V}$	$\approx 0.1 \times$ value stated in Table 2

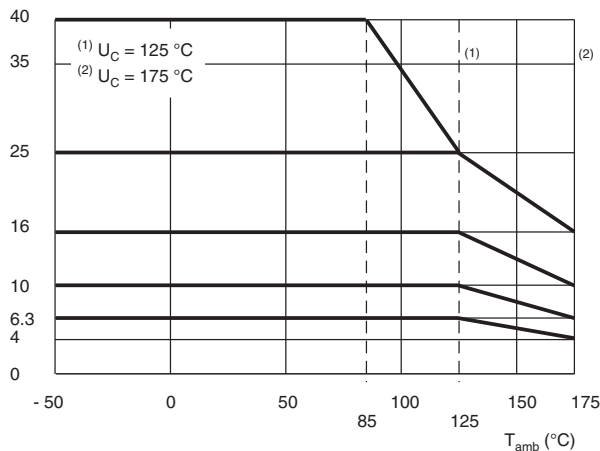
**VOLTAGE**

 Fig. 5 - Maximum permissible voltage up to  $T_{amb} = 175 \text{ }^\circ\text{C}$ 
**RIPPLE CURRENT ( $I_R$ )**

PARAMETER	$T_{amb}$					
	25 °C	40 °C	65 °C	85 °C	105 °C	125 °C
$I_R$ multiplier	1.1	1.0	0.88	0.75	0.59	0.37

**Notes**

- (1) Applying the maximum RMS ripple current given in Table 2 will cause a device temperature of  $138 \text{ }^\circ\text{C}$
- (2) The 100 kHz values in Table 2 for other temperatures are to be calculated with the above  $I_R$  multipliers

**CAPACITANCE (C)**

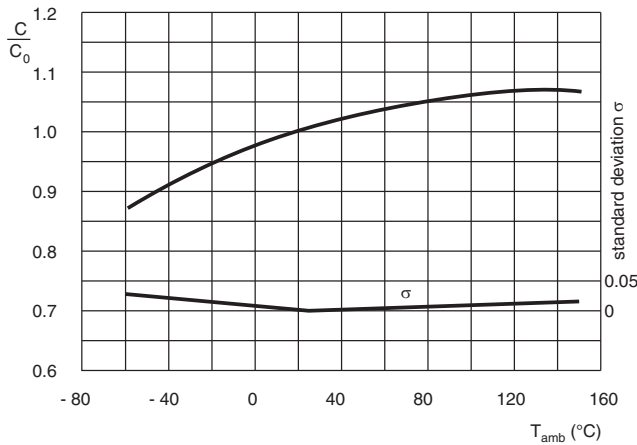

Fig. 6 - Typical multiplier of capacitance and standard deviation as functions of ambient temperature

**TYPICAL CAPACITANCE CHANGE AFTER ENDURANCE TEST AT  $T_{amb} = 125\text{ }^{\circ}\text{C}$**

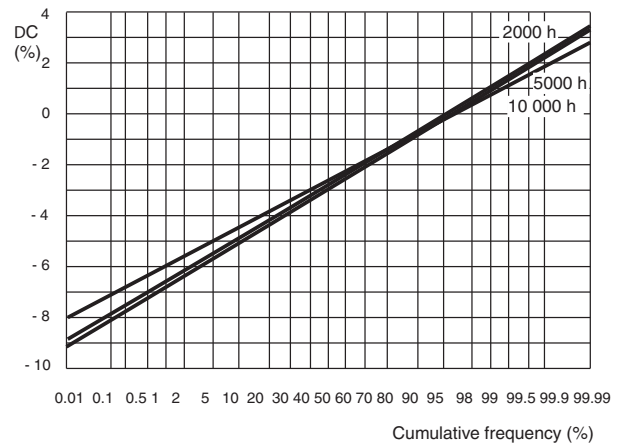
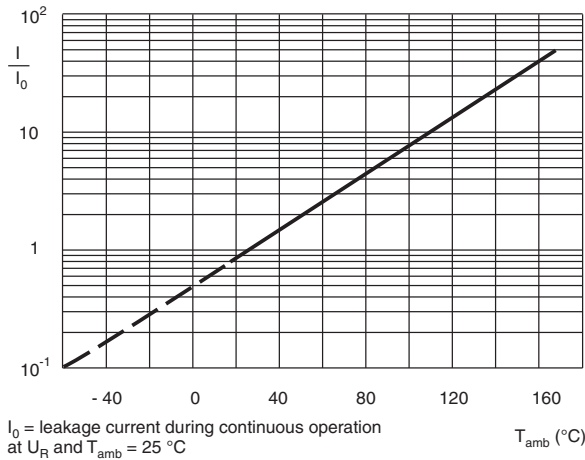

Fig. 7 - Change of capacitance as a function of cumulative frequency after endurance test

**LEAKAGE CURRENT**



$I_0$  = leakage current during continuous operation at  $U_R$  and  $T_{amb} = 25\text{ }^{\circ}\text{C}$

Fig. 8 - Typical multiplier of leakage current as a function of ambient temperature

**TYPICAL LEAKAGE CURRENT CHANGE AFTER ENDURANCE TEST AT  $T_{amb} = 125\text{ }^{\circ}\text{C}$**

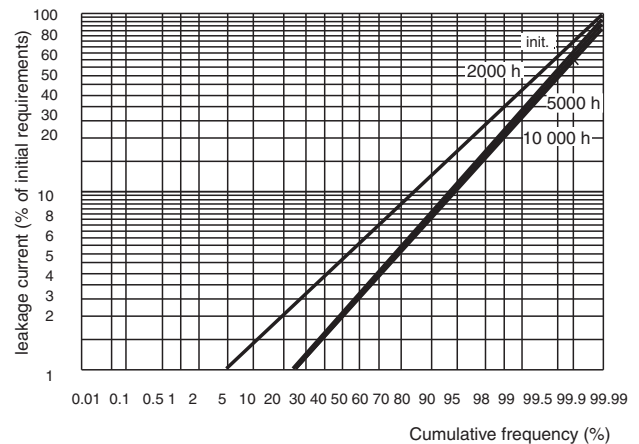

Fig. 9 - Change of capacitance as a function of cumulative frequency after endurance test

**DISSIPATION FACTOR ( $\tan \delta$ )**

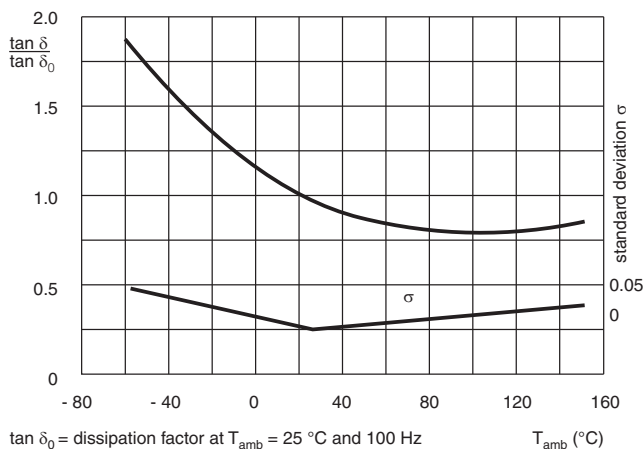

Fig. 10 - Typical multiplier of dissipation factor and standard deviation as functions of ambient temperature

**TYPICAL  $\tan \delta$  CHANGE AFTER ENDURANCE TEST AT  $T_{amb} = 125^\circ\text{C}$**

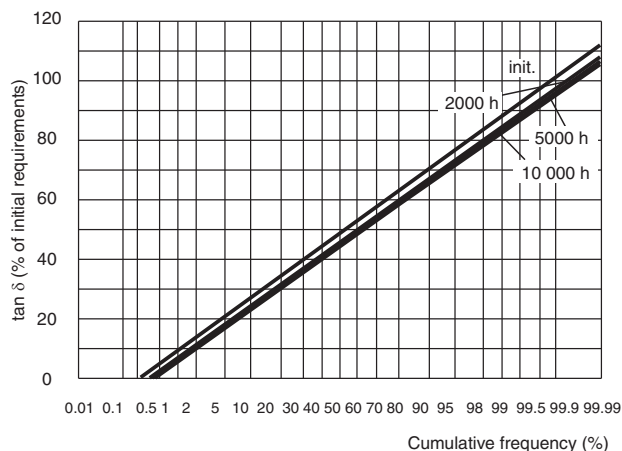

Fig. 11 -  $\tan \delta$  change of capacitance as a function of cumulative frequency after endurance test

**EQUIVALENT SERIES RESISTANCE (ESR)**

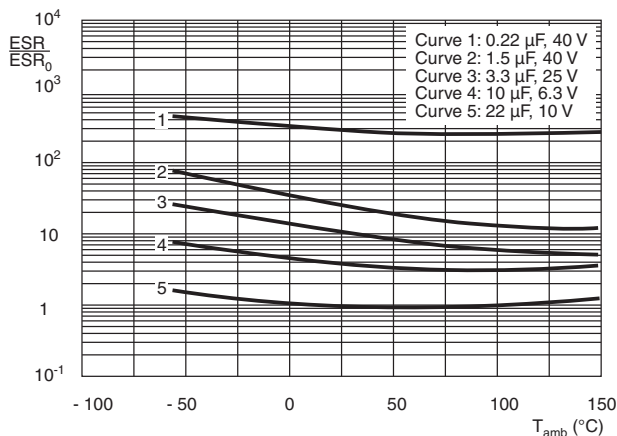

Fig. 12 - Typical multiplier of ESR at 100 Hz as a function of ambient temperature

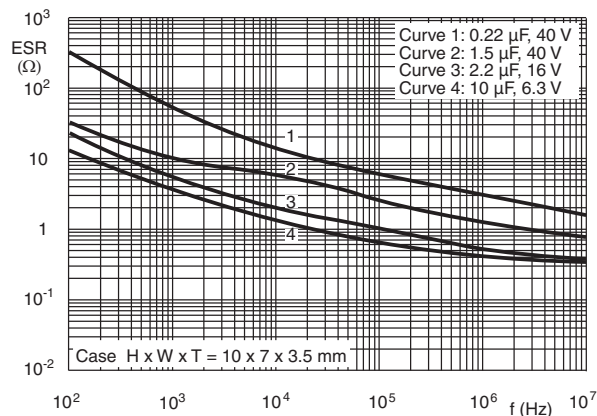

Fig. 13 - Typical ESR at  $25^\circ\text{C}$  as a function of frequency

**EQUIVALENT SERIES RESISTANCE (ESR)**

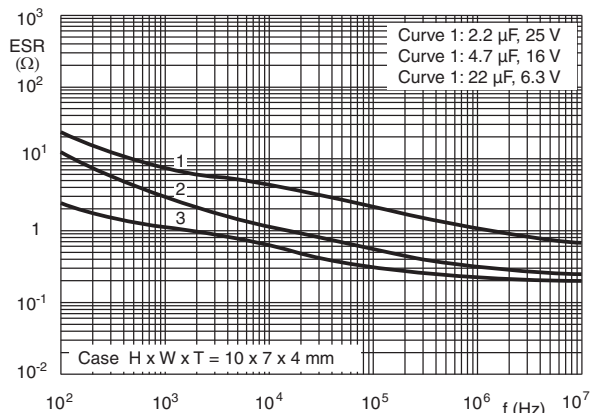

Fig. 14 - Typical ESR at 25 °C as a function of frequency

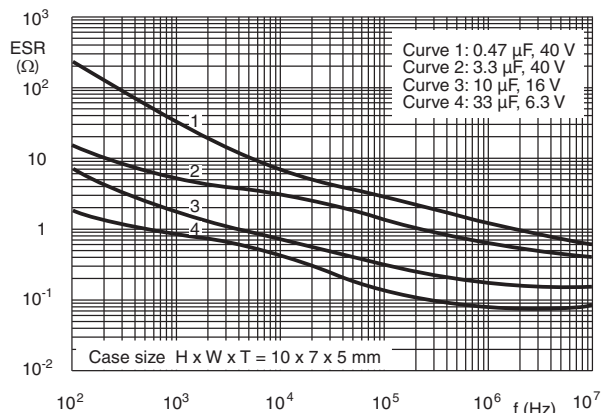

Fig. 15 - Typical ESR at 25 °C as a function of frequency

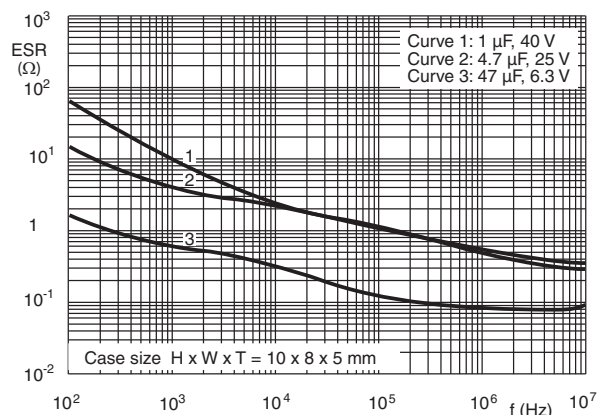

Fig. 16 - Typical ESR as a function of frequency

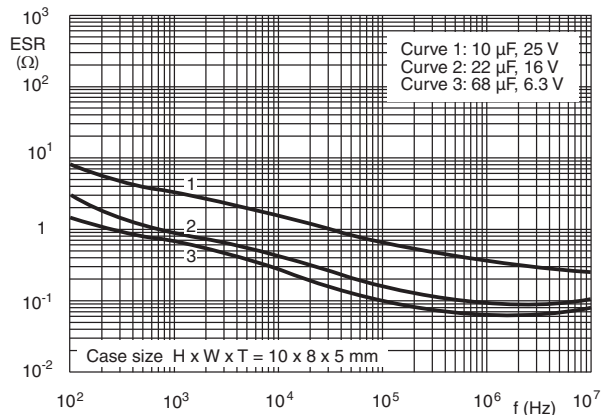

Fig. 17 - Typical ESR at 25 °C as a function of frequency

**IMPEDANCE (Z)**

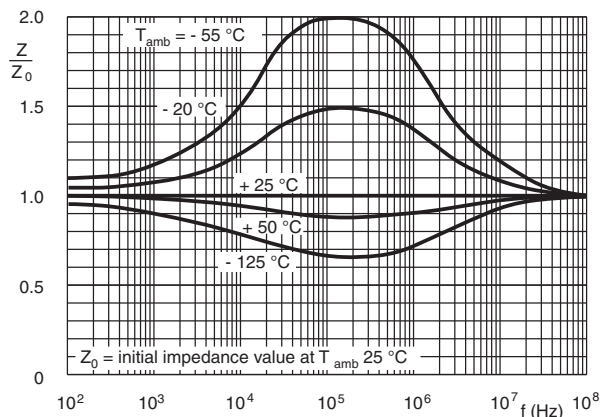

Fig. 18 - Typical multiplier of impedance as a function of frequency at different ambient temperatures

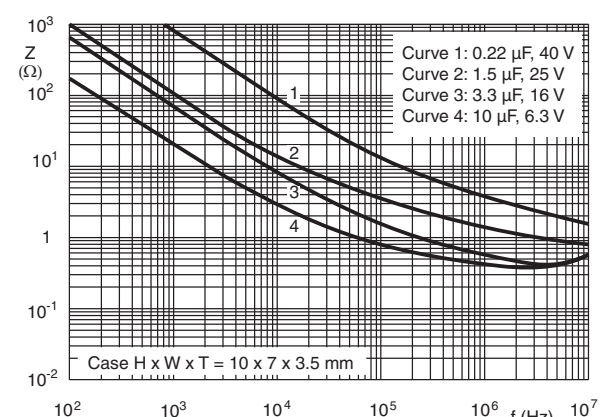

Fig. 19 - Typical impedance at 25 °C as a function of frequency

**IMPEDANCE (Z)**

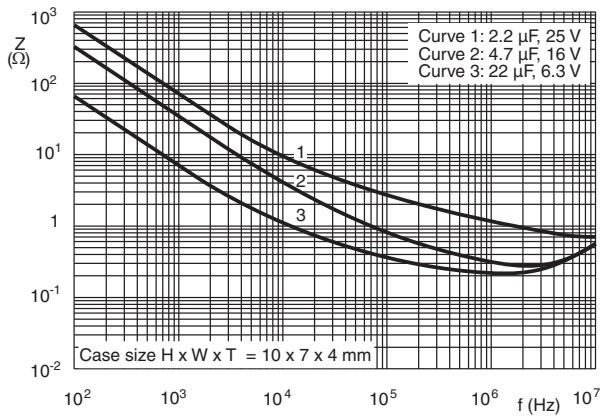

Fig. 20 - Typical impedance at 25 °C as a function of frequency

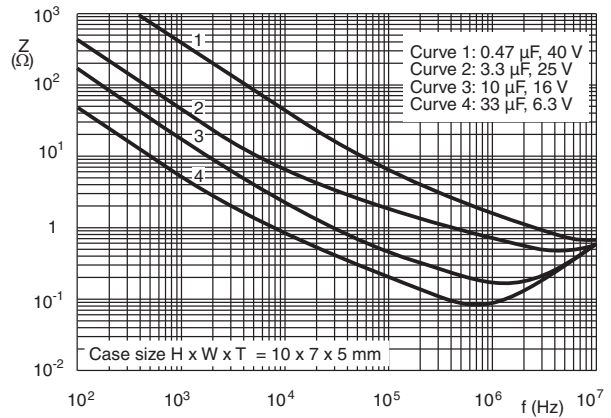

Fig. 21 - Typical impedance at 25 °C as a function of frequency

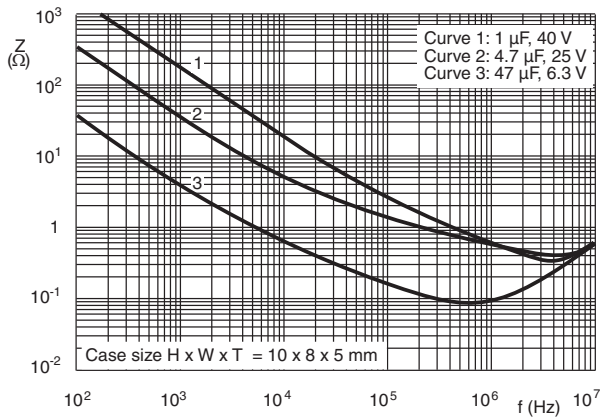

Fig. 22 - Typical impedance at 25 °C as a function of frequency

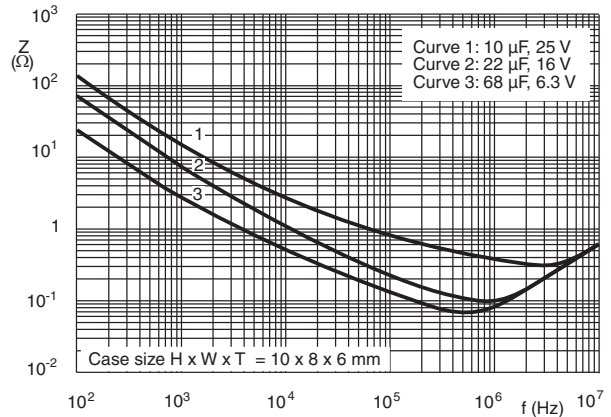

Fig. 23 - Typical impedance at 25 °C as a function of frequency



**Table 3**

<b>TEST PROCEDURES AND REQUIREMENTS</b>			
<b>TEST</b>		<b>PROCEDURE (quick reference)</b>	<b>REQUIREMENTS</b>
<b>NAME OF TEST</b>	<b>REFERENCE</b>		
Endurance	IEC 60384-4/ EN130300 subclause 4.13	$T_{amb} = 125\text{ }^{\circ}\text{C}$ ; $U_R = 6.3\text{ V}$ to $25\text{ V}$ with $U_R$ applied; $U_R = 40\text{ V}$ with $U_C$ applied; 10 000 h	$\Delta C/C: \pm 10\%$ $\tan \delta \leq 1.2 \times \text{spec. limit}$ $Z \leq 1.2 \times \text{spec. limit}$ $I_{L5} \leq \text{spec. limit}$
Useful life	CECC 30302 subclause 1.8.1	$T_{amb} = 125\text{ }^{\circ}\text{C}$ ; $I_R$ applied and: $U_R = 6.3\text{ V}$ to $25\text{ V}$ with $U_R$ applied; $U_R = 40\text{ V}$ with $U_C$ applied; 20 000 h	$\Delta C/C: \pm 15\%$ $\tan \delta \leq 1.5 \times \text{spec. limit}$ $Z \leq 1.5 \times \text{spec. limit}$ $I_{L5} \leq \text{spec. limit}$ no short or open circuit, no visible damage total failure percentage: $< 1\%$
Shelf life (storage at high temperature)	IEC 60384-4/ EN130300 subclause 4.17	$T_{amb} = 125\text{ }^{\circ}\text{C}$ ; no voltage applied; 500 h	$\Delta C/C: \pm 10\%$ $\tan \delta \leq 1.2 \times \text{spec. limit}$ $I_{L5} \leq \text{spec. limit}$
Charge and discharge	IEC 60384-4-2 subclause 9.21	$10^6$ cycles without series resistance: 0.5 s to $U_R$ ; 0.5 s to ground	$\Delta C/C: \pm 5\%$ no short or open circuit, no visible damage
Solvent resistance	IEC 60068-2-45, test XA IEC 60653	Immersion: 5 min $\pm$ 0.5 min with or without ultrasonic at $55\text{ }^{\circ}\text{C} \pm 5\text{ }^{\circ}\text{C}$ Solvents: demineralized water and/or calgonite solution (20 g/l)	Visual appearance not affected
Extended vibration	IEC 60068-2-6 test Fc	10 Hz to 2000 Hz; 1.5 mm or 20 g; 1 octave/min; 3 directions; 1 sweep per direction; no voltage applied	no intermittent contacts no breakdown no open circuiting no mechanical damage $\Delta C/C: \pm 5\%$ $\tan \delta \leq 1.2 \times \text{spec. limit}$ $Z \leq 1.2 \times \text{spec. limit}$ $I_{L5} \leq 1.5 \times \text{spec. limit}$
Shock	IEC 60068-2-27 test Ea	Half-sine or sawtooth pulse shape; 50 g; 11 ms; 3 successive shocks in each direction of 3 mutually perpendicular axes; no voltage applied	no intermittent contacts no breakdown no open circuiting no mechanical damage $\Delta C/C: \pm 5\%$ $\tan \delta \leq 1.2 \times \text{spec. limit}$ $Z \leq 1.2 \times \text{spec. limit}$ $I_{L5} \leq 1.5 \times \text{spec. limit}$
Passive flammability	IEC 60695-2-2	Capacitor mounted to a vertical printed-circuit board, one flame on capacitor body; $T_{amb} = 20\text{ }^{\circ}\text{C}$ to $25\text{ }^{\circ}\text{C}$ ; test duration = 20 s	After removing the test flame from the capacitor, the capacitor must not continue to burn for more than 15 s; no burning particles must drop from the sample



## Disclaimer

ALL PRODUCT, PRODUCT SPECIFICATIONS AND DATA ARE SUBJECT TO CHANGE WITHOUT NOTICE TO IMPROVE RELIABILITY, FUNCTION OR DESIGN OR OTHERWISE.

Vishay Intertechnology, Inc., its affiliates, agents, and employees, and all persons acting on its or their behalf (collectively, "Vishay"), disclaim any and all liability for any errors, inaccuracies or incompleteness contained in any datasheet or in any other disclosure relating to any product.

Vishay makes no warranty, representation or guarantee regarding the suitability of the products for any particular purpose or the continuing production of any product. To the maximum extent permitted by applicable law, Vishay disclaims (i) any and all liability arising out of the application or use of any product, (ii) any and all liability, including without limitation special, consequential or incidental damages, and (iii) any and all implied warranties, including warranties of fitness for particular purpose, non-infringement and merchantability.

Statements regarding the suitability of products for certain types of applications are based on Vishay's knowledge of typical requirements that are often placed on Vishay products in generic applications. Such statements are not binding statements about the suitability of products for a particular application. It is the customer's responsibility to validate that a particular product with the properties described in the product specification is suitable for use in a particular application. Parameters provided in datasheets and/or specifications may vary in different applications and performance may vary over time. All operating parameters, including typical parameters, must be validated for each customer application by the customer's technical experts. Product specifications do not expand or otherwise modify Vishay's terms and conditions of purchase, including but not limited to the warranty expressed therein.

Except as expressly indicated in writing, Vishay products are not designed for use in medical, life-saving, or life-sustaining applications or for any other application in which the failure of the Vishay product could result in personal injury or death. Customers using or selling Vishay products not expressly indicated for use in such applications do so at their own risk and agree to fully indemnify and hold Vishay and its distributors harmless from and against any and all claims, liabilities, expenses and damages arising or resulting in connection with such use or sale, including attorneys fees, even if such claim alleges that Vishay or its distributor was negligent regarding the design or manufacture of the part. Please contact authorized Vishay personnel to obtain written terms and conditions regarding products designed for such applications.

No license, express or implied, by estoppel or otherwise, to any intellectual property rights is granted by this document or by any conduct of Vishay. Product names and markings noted herein may be trademarks of their respective owners.

## Material Category Policy

**Vishay Intertechnology, Inc. hereby certifies that all its products that are identified as RoHS-Compliant fulfill the definitions and restrictions defined under Directive 2011/65/EU of The European Parliament and of the Council of June 8, 2011 on the restriction of the use of certain hazardous substances in electrical and electronic equipment (EEE) - recast, unless otherwise specified as non-compliant.**

**Please note that some Vishay documentation may still make reference to RoHS Directive 2002/95/EC. We confirm that all the products identified as being compliant to Directive 2002/95/EC conform to Directive 2011/65/EU.**