



## PolySwitch Resettable Devices Surface-mount Devices

PolySwitch surface-mount devices are the preferred circuit protection method for computer, consumer, multimedia, portable, and automotive electronics applications.

In an effort to reduce the size and cost of surface-mount devices, we introduced the miniSMD product series in 1995. Subsequently, we developed the microSMD, nanoSMD, picoSMD and femtoSMD family of products. The femtoSMD series reduced the device size to a 1608mm (0603 mils) footprint, one twelfth the size of the popular miniSMD series.

Recent additions to the PolySwitch surface-mount series include 0.5A picoSMD 1210mm (0805 mils) and 0.35A femtoSMD 1608mm (0603 mils) devices.

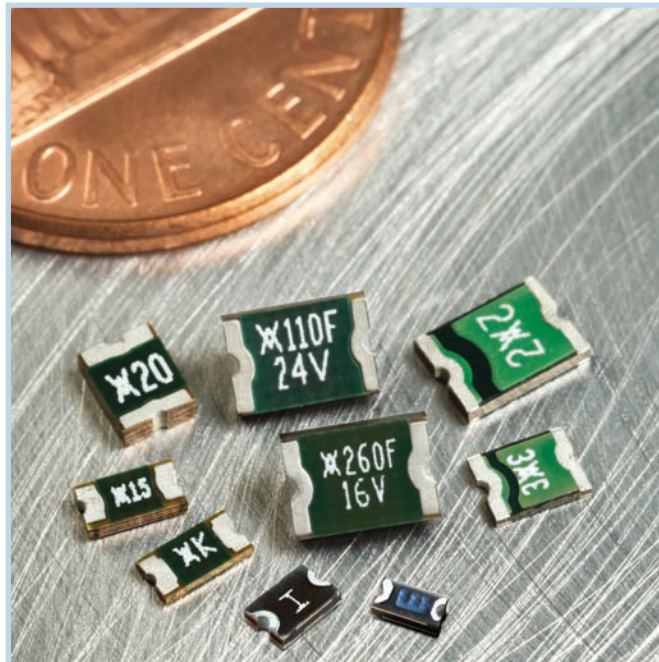

### Benefits

- Smaller size saves board space and cost
- Many product choices give engineers more design flexibility
- Compatible with high-volume electronics assembly
- Assists in meeting regulatory requirements
- Higher voltage ratings allow use in new applications

### Features

- RoHS compliant
- Halogen free (refers to: Br≤900ppm, Cl≤900ppm, Br+Cl≤1500ppm)
- Broadest range of resettable devices available in the industry
- Current ratings from 0.05 to 3A
- Voltage ratings from 6V computer and electronic applications to 60V telecom applications
- Agency recognition: UL, CSA, TÜV
- Small footprint
- Fast time-to-trip
- Low resistance

### Applications

- |                        |                           |                       |
|------------------------|---------------------------|-----------------------|
| • Computer             | • Game machines           | • Automotive          |
| • Portable electronics | • Telephony and broadband | • Industrial controls |
| • Multimedia           | • Mobile phones           | • Battery             |

## Application Selection Table for Surface-mount Devices

- The table below lists PolySwitch surface-mount devices typically used in these applications.
- Specifications for the suggested PolySwitch surface-mount device part numbers can be found in this section.
- Once a part has been selected, the user should evaluate and test each product for the intended application.

Protection Application	Additional Comments	Overcurrent Overvoltage	PolySwitch Resettable Devices - Key Selection Criteria		
			Small Size	Low Resistance	Fast Time-to-trip (Temperature Protection)
AC adapter input power	use w/ Zener & triac		SMD250F	SMD250F	SMD200F
Battery pack protection			nanoSMDC150F	miniSMDC260F	miniSMDE190F
Charger protection			nanoSMDC050F	miniSMDC110F/16	nanoSMDC075F
CPU/IC protection			nanoSMDC110F	nanoSMDC150F	nanoSMDC075F
Data acquisition/sensor			microSMD005F	-	microSMD005F
DC input/output power	≤6V		nanoSMDC075F	nanoSMDC150F	nanoSMDC050F/13.2
	≤12V		miniSMDC075F	miniSMDC110F/16	miniSMDC075F
DDC			nanoSMDC075F	nanoSMDC110F	nanoSMDC050F/13.2
Device bay system	DB12, DB20		miniSMDC200F	miniSMDC260F	miniSMDC200F
	DB32		miniSMDC260F	SMD300F	miniSMDC200F
Ethernet/LAN			nanoSMDC050F/13.2	miniSMDC110F/16	nanoSMDC075F
Fan			microSMD035F	microSMD050F	microSMD035F
HDMI			picoSMDC035S	picoSMDC035S	picoSMDC035S
IEEE 802.3af	VOIP		decaSMDC050F/60	decaSMDC050F/60	decaSMDC050F/60
IEEE-1394	power provider		SMD100F/33	SMD185F	SMD100F/33
	alt. power provider		SMD185F	SMD185F	SMD150F/33
	self-powered		SMD185F	SMD185F	SMD150F/33
LCD inverter			nanoSMDC050F/13.2	miniSMDC110F/16	nanoSMDC075F
LCD screen power			nanoSMDC050F/13.2	nanoSMDC050F/13.2	microSMD035F
LNB (Low Noise Block)			SMD075F	SMD075F	SMD050F
Motor	≤6V		nanoSMDC110F	nanoSMDC150F	microSMD075F
	≤13.2V		miniSMDC075F	miniSMDC110F/16	miniSMDC075F
PS/2 mouse/keyboard			nanoSMDC075F	nanoSMDC110F	nanoSMDC050F/13.2
Signal - data communication	≤6V		nanoSMDC075F	nanoSMDC075F	nanoSMDC075F
	≤13.2V		miniSMDC050F	miniSMDC075F	miniSMDC020F
	≤30V		SMD030F-2018	SMD075F	SMD050F
SCSI			nanoSMDC110F	nanoSMDC150F	nanoSMDC075F
SIM/Smart card reader			femtoSMDC010F	femtoSMDC010F	femtoSMDC005F
Telecom - modem	Digital line	OC	miniSMDC014F	miniSMDC014F	miniSMDC014F
Telecom - PBX	Subscriber	OC	miniSMDC014F	miniSMDC014F	miniSMDC014F
Temperature sensor	CPU		nanoSMDC050F/13.2	nanoSMDC075F	nanoSMDC050F/13.2
USB	Individual Port		nanoSMDC075F	nanoSMDC110F	nanoSMDC050F/13.2
	2 port ganged		nanoSMDC150F	miniSMDC150F	miniSMDC125F
	3 port ganged		miniSMDC200F	miniSMDC200F	miniSMDC200F

**Note:** This list is not exhaustive. TE Circuit Protection welcomes our customers' input for additional application ideas for PolySwitch resettable devices.

**Table S1 Product Series: Size, Current Rating, Voltage Rating/Maximum Resistance for Surface-mount Devices**

	femtoSMD	picoSMD	nanoSMD	microSMD	miniSMD	midSMD	SMD	SMD2	miniSMDE	decaSMD
<b>Size mm</b>	1608	2012	3216	3225	4532	5050	7555	8763	11550	5050
<b>(mils)</b>	(0603)	(0805)	(1206)	(1210)	(1812)	(2018)	(2920)	(3425)	(4420)	(2018)
<b>Hold Current (A)</b>										
0.050	15V <sub>DC</sub> /30.00Ω	—	—	30V <sub>DC</sub> /50Ω	—	—	—	—	—	—
0.080	12V <sub>DC</sub> /14.00Ω	—	—	—	—	—	—	—	—	—
0.100	12V <sub>DC</sub> /8.00Ω	15V <sub>DC</sub> /11.00Ω	—	30V <sub>DC</sub> /15Ω	60V <sub>DC</sub> /12.70Ω	—	—	—	—	—
0.120	9V <sub>DC</sub> /5.80Ω	15V <sub>DC</sub> /9.00Ω	48V <sub>DC</sub> /6.50Ω	—	—	—	—	—	—	—
0.140	—	—	—	—	60V <sub>DC</sub> /6.00Ω	—	—	—	—	—
0.160	9V <sub>DC</sub> /4.20Ω	—	48V <sub>DC</sub> /5.00Ω	—	—	—	—	—	—	—
0.200	9V <sub>DC</sub> /3.00Ω	9V <sub>DC</sub> /3.20Ω	24V <sub>DC</sub> /3.10Ω	—	30V <sub>DC</sub> /3.30Ω	—	—	—	—	—
0.250	—	—	16V <sub>DC</sub> /2.30Ω	—	—	—	—	—	—	—
0.300	—	—	—	—	30V <sub>DC</sub> /1.75Ω	60V <sub>DC</sub> /2.30Ω	60V <sub>DC</sub> /4.80Ω	—	—	—
0.350	6V <sub>DC</sub> /1.00Ω	6V <sub>DC</sub> /1.40Ω	16V <sub>DC</sub> /1.35Ω	6V <sub>DC</sub> /1.30Ω	—	—	—	—	—	—
0.500	—	6V <sub>DC</sub> /0.80Ω	13.2V <sub>DC</sub> /0.75Ω	13.2V <sub>DC</sub> /0.90Ω	24V <sub>DC</sub> /1.00Ω	—	60V <sub>DC</sub> /1.40Ω	—	—	60V <sub>DC</sub> /1.10Ω
0.750	—	6V <sub>DC</sub> /0.31Ω*	6V <sub>DC</sub> /0.30Ω	6V <sub>DC</sub> /0.40Ω	13.2V <sub>DC</sub> /0.45Ω	—	30V <sub>DC</sub> /1.00Ω	—	—	—
	—	—	—	—	24V <sub>DC</sub> /0.29Ω	—	60V <sub>DC</sub> /1.00Ω	—	—	—
1.000	—	—	—	—	—	15V <sub>DC</sub> /0.40Ω	30V <sub>DC</sub> /0.48Ω	—	—	—
	—	—	—	—	—	—	33V <sub>DC</sub> /0.41Ω	—	—	—
1.100	—	6V <sub>DC</sub> /0.16Ω*	6V <sub>DC</sub> /0.20Ω	6V <sub>DC</sub> /0.21Ω	8V <sub>DC</sub> /0.21Ω	—	—	—	—	—
	—	—	—	—	16V <sub>DC</sub> /0.18Ω	—	—	—	—	—
	—	—	—	—	24V <sub>DC</sub> /0.18Ω	—	—	—	—	—
1.200	—	—	—	—	—	—	16V <sub>DC</sub> /0.34Ω	—	—	—
1.250	—	—	—	—	6V <sub>DC</sub> /0.14Ω	—	15V <sub>DC</sub> /0.25Ω	—	—	—
	—	—	—	—	16V <sub>DC</sub> /0.14Ω	—	—	—	—	—
1.500	—	—	6V <sub>DC</sub> /0.11Ω	6V <sub>DC</sub> /0.11Ω	6V <sub>DC</sub> /0.11Ω	15V <sub>DC</sub> /0.18Ω	—	15V <sub>DC</sub> /0.25Ω	—	—
	—	—	—	—	12V <sub>DC</sub> /0.11Ω	—	—	33V <sub>DC</sub> /0.23Ω	—	—
	—	—	—	—	16V <sub>DC</sub> /0.11Ω	—	—	—	—	—
	—	—	—	—	24V <sub>DC</sub> /0.12Ω	—	—	—	—	—
1.600	—	—	—	—	9V <sub>DC</sub> /0.10Ω	—	—	16V <sub>DC</sub> /0.15Ω	—	—
1.750	—	—	—	6V <sub>DC</sub> /0.08Ω	—	—	—	—	—	—
1.850	—	—	—	—	—	—	—	33V <sub>DC</sub> /0.165Ω	—	—
1.900	—	—	—	—	—	—	—	—	16V <sub>DC</sub> /0.08Ω	—
2.000	—	—	6V <sub>DC</sub> /0.072Ω	6V <sub>DC</sub> /0.06Ω	8V <sub>DC</sub> /0.07Ω	6V <sub>DC</sub> /0.10Ω	—	15V <sub>DC</sub> /0.125Ω	—	—
2.500	—	—	—	—	—	—	—	15V <sub>DC</sub> /0.85Ω	—	—
2.600	—	—	—	—	6V <sub>DC</sub> /0.043Ω	—	6V <sub>DC</sub> /0.075Ω	—	—	—
	—	—	—	—	12V <sub>DC</sub> /0.047Ω	—	—	—	—	—
	—	—	—	—	13.2V <sub>DC</sub> /0.050Ω	—	—	—	—	—
	—	—	—	—	16V <sub>DC</sub> /0.050Ω	—	—	—	—	—
3.000	—	—	—	—	6V <sub>DC</sub> /0.036Ω	—	6V <sub>DC</sub> /0.048Ω	—	—	—
	—	—	—	—	—	—	15V <sub>DC</sub> /0.05Ω	—	—	—

\* Data is preliminary

**Table S2 Thermal Derating for Surface-mount Devices  
[Hold Current (A) at Ambient Temperature (°C)]**

		Maximum Ambient Temperature											
Part Number	-40°C	-20°C	0°C	20°C	25°C	40°C	50°C	60°C	70°C	80°C	85°C	125°C	
<b>femtoSMDC Series</b>													
<b>Size 1608 mm/0603 mils</b>													
NEW	femtoSMDC005F	0.08	0.07	0.06	0.05	0.05	0.04	0.04	0.03	0.03	0.02	0.02	—
NEW	femtoSMDC008F	0.13	0.11	0.10	0.08	0.08	0.07	0.06	0.06	0.05	0.04	0.04	—
NEW	femtoSMDC010F	0.16	0.14	0.12	0.11	0.10	0.09	0.08	0.07	0.06	0.05	0.04	—
NEW	femtoSMDC012F	0.18	0.16	0.14	0.12	0.12	0.11	0.10	0.08	0.08	0.07	0.06	—
	femtoSMDC016F	0.25	0.22	0.18	0.17	0.16	0.14	0.12	0.11	0.10	0.08	0.07	—
NEW	femtoSMDC020F	0.30	0.27	0.24	0.20	0.20	0.17	0.16	0.14	0.12	0.11	0.10	—
NEW	femtoSMDC035F	0.53	0.47	0.41	0.36	0.35	0.30	0.27	0.25	0.22	0.19	0.17	—
<b>picoSMDC Series</b>													
<b>Size 2012 mm/0805 mils</b>													
NEW	picoSMDC010S	0.17	0.15	0.13	0.11	0.10	0.09	0.08	0.07	0.06	0.05	0.05	—
NEW	picoSMDC012S	0.20	0.17	0.15	0.13	0.12	0.10	0.09	0.08	0.07	0.06	0.05	—
	picoSMDC020S	0.30	0.27	0.24	0.21	0.20	0.18	0.16	0.15	0.13	0.12	0.11	—
	picoSMDC035S	0.55	0.49	0.44	0.37	0.35	0.31	0.28	0.26	0.23	0.20	0.18	—
NEW	picoSMDC050S	0.70	0.62	0.55	0.55	0.50	0.43	0.38	0.33	0.30	0.28	0.26	—
coming soon	picoSMDC075S*	1.17	1.05	0.94	0.81	0.75	0.68	0.62	0.57	0.50	0.44	0.41	—
coming soon	picoSMDC110S*	1.61	1.46	1.21	1.15	1.10	0.94	0.84	0.75	0.72	0.68	0.64	—
<b>nanoSMDC Series</b>													
<b>Size 3216 mm/1206 mils</b>													
	nanoSMDC012F	0.20	0.17	0.15	0.13	0.12	0.11	0.10	0.09	0.08	0.07	0.07	—
	nanoSMDC016F	0.21	0.20	0.18	0.16	0.16	0.14	0.13	0.12	0.11	0.10	0.09	—
	nanoSMDC020F	0.34	0.30	0.26	0.22	0.20	0.17	0.15	0.13	0.11	0.09	0.08	—
NEW	nanoSMDC025F	0.38	0.33	0.30	0.26	0.25	0.22	0.20	0.19	0.16	0.13	0.11	—
	nanoSMDC035F	0.58	0.51	0.44	0.38	0.35	0.31	0.28	0.24	0.21	0.18	0.16	—
	nanoSMDC050F/13.2	0.78	0.69	0.61	0.52	0.50	0.44	0.39	0.35	0.30	0.25	0.24	—
	nanoSMDC075F	1.15	1.04	0.92	0.78	0.75	0.69	0.63	0.58	0.51	0.46	0.43	—
	nanoSMDC110F	1.64	1.46	1.30	1.10	1.06	0.92	0.83	0.80	0.65	0.56	0.52	—
	nanoSMDC150F	2.20	1.99	1.77	1.55	1.50	1.34	1.23	1.10	1.01	0.90	0.84	—
	nanoSMDC200F	2.92	2.64	2.35	2.07	2.00	1.79	1.64	1.50	1.36	1.22	1.15	—
<b>microSMD Series</b>													
<b>Size 3225 mm/1210 mils</b>													
	microSMD005F	0.08	0.07	0.06	0.05	0.05	0.04	0.04	0.03	0.03	0.02	0.02	—
	microSMD010F	0.15	0.13	0.12	0.10	0.10	0.09	0.08	0.06	0.06	0.05	0.05	—
	microSMD035F	0.51	0.46	0.40	0.35	0.34	0.30	0.27	0.24	0.22	0.19	0.18	—
	microSMD050F	0.76	0.66	0.58	0.50	0.48	0.42	0.38	0.35	0.29	0.25	0.23	—
	microSMD075F	1.10	0.97	0.86	0.75	0.72	0.64	0.58	0.55	0.47	0.42	0.39	—
	microSMD110F	1.60	1.42	1.26	1.10	1.06	0.94	0.86	0.80	0.70	0.62	0.58	—
	microSMD150F	2.30	2.02	1.76	1.50	1.43	1.24	1.11	1.00	0.85	0.72	0.65	—
	microSMD175F	2.80	2.45	2.10	1.75	1.70	1.55	1.45	1.35	1.25	1.15	1.10	—
	microSMD200F	2.60	2.44	2.35	2.00	1.96	1.78	1.67	1.50	1.45	1.15	1.10	—
<b>miniSMDC Series</b>													
<b>Size 4532 mm/1812 mils</b>													
	miniSMDC010F	0.17	0.15	0.13	0.11	0.10	0.09	0.08	0.07	0.06	0.05	0.04	—
	miniSMDC014F	0.23	0.20	0.17	0.14	0.13	0.11	0.10	0.09	0.07	0.06	0.05	—
	miniSMDC020F	0.30	0.27	0.23	0.20	0.19	0.17	0.15	0.13	0.12	0.10	0.09	—
	miniSMDC030F	0.49	0.44	0.39	0.32	0.30	0.27	0.24	0.22	0.18	0.16	0.14	—
	miniSMDC050F	0.59	0.57	0.55	0.50	0.48	0.45	0.43	0.35	0.30	0.25	0.23	—
	miniSMDC075F	1.10	0.99	0.87	0.75	0.72	0.63	0.57	0.49	0.45	0.39	0.35	—
	miniSMDC075F/24	1.50	1.25	1.00	0.75	0.73	0.65	0.60	0.55	0.50	0.45	0.43	—
	miniSMDC100F	1.60	1.45	1.28	1.10	1.07	0.92	0.83	0.71	0.66	0.57	0.52	—

\* Data is preliminary

**Table S2 Thermal Derating for Surface-mount Devices  
[Hold Current (A) at Ambient Temperature (°C)]**

Cont'd

Part Number	Maximum Ambient Temperature											
	-40°C	-20°C	0°C	20°C	25°C	40°C	50°C	60°C	70°C	80°C	85°C	125°C
<b>miniSMDC Series</b>												
<b>Size 4532 mm/1812 mils</b>												
miniSMDC110F	1.60	1.45	1.28	1.10	1.07	0.92	0.83	0.71	0.66	0.57	0.52	—
miniSMDC110F/16	1.68	1.49	1.30	1.10	1.05	0.92	0.83	0.75	0.64	0.55	0.50	—
miniSMDC110F/24	2.00	1.70	1.40	1.10	1.06	0.95	0.88	0.80	0.73	0.65	0.61	—
miniSMDC125F	2.00	1.69	1.47	1.25	1.17	1.03	0.92	0.90	0.69	0.58	0.53	—
miniSMDC125F/16	2.00	1.69	1.47	1.25	1.17	1.03	0.92	0.90	0.69	0.58	0.53	—
miniSMDC150F	2.30	2.05	1.77	1.50	1.44	1.23	1.09	0.95	0.82	0.68	0.61	—
miniSMDC150F/12	2.40	2.10	1.80	1.50	1.44	1.25	1.13	1.00	0.88	0.75	0.69	—
miniSMDC150F/16	2.40	2.10	1.80	1.50	1.44	1.25	1.13	1.00	0.88	0.75	0.69	—
miniSMDC150F/24	2.10	1.90	1.70	1.50	1.44	1.25	1.13	1.00	0.88	0.75	0.69	—
miniSMDC160F	2.50	2.19	1.89	1.60	1.53	1.31	1.16	1.10	0.95	0.79	0.71	—
miniSMDC200F	2.60	2.44	2.22	2.00	1.96	1.78	1.67	1.50	1.45	1.34	1.29	—
miniSMDC260F	3.40	3.16	2.80	2.60	2.54	2.32	2.18	2.00	1.90	1.76	1.69	—
miniSMDC260F/12	3.40	3.16	3.00	2.60	2.54	2.32	2.18	2.00	1.90	1.76	1.69	—
miniSMDC260F/13.2	3.40	3.16	3.00	2.60	2.54	2.32	2.18	2.00	1.90	1.76	1.69	—
miniSMDC260F/16	3.50	3.20	3.00	2.60	2.53	2.30	2.15	2.00	1.85	1.70	1.63	—
miniSMDC300F	4.13	3.75	3.33	3.02	3.00	2.70	2.54	2.35	2.22	2.06	1.98	—
<b>miniSMDE Series</b>												
<b>Size 11550 mm/4420 mils</b>												
miniSMDE190F	3.16	2.74	2.20	1.90	1.74	1.48	1.27	1.10	0.80	0.50	0.35	—
<b>midSMD Series</b>												
<b>Size 5050 mm/2018 mils</b>												
SMD030F-2018	0.48	0.42	0.35	0.30	0.28	0.24	0.21	0.17	0.15	0.12	0.10	—
decaSMDC050F/60	1.00	0.85	0.70	0.55	0.53	0.45	0.40	0.35	0.30	0.25	0.23	—
SMD100F-2018	1.59	1.43	1.20	1.10	1.03	0.94	0.85	0.72	0.69	0.61	0.57	—
SMD150F-2018	2.21	1.97	1.70	1.50	1.43	1.26	1.15	1.00	0.91	0.79	0.73	—
SMD200F-2018	2.81	2.54	2.27	2.00	1.93	1.73	1.59	1.46	1.32	1.19	1.12	—
<b>SMD Series</b>												
<b>Size 7555 mm/2920 mils</b>												
SMD030F	0.44	0.39	0.32	0.30	0.28	0.26	0.23	0.19	0.18	0.17	0.15	—
SMD050F	0.73	0.65	0.55	0.50	0.47	0.43	0.39	0.33	0.31	0.28	0.26	—
SMD075F	1.11	0.99	0.84	0.75	0.71	0.63	0.57	0.49	0.45	0.39	0.36	—
SMD075F/60	1.11	0.99	0.84	0.75	0.71	0.63	0.57	0.49	0.45	0.39	0.36	—
SMD100F	1.59	1.43	1.20	1.10	1.03	0.94	0.85	0.72	0.69	0.61	0.57	—
SMD100F/33	1.48	1.35	1.20	1.10	1.06	0.98	0.91	0.83	0.79	0.73	0.69	—
SMDH120	2.34	1.96	1.58	1.20	1.15	1.02	0.92	0.83	0.74	0.65	0.60	0.26
SMD125F	1.89	1.68	1.50	1.25	1.21	1.04	0.93	0.85	0.71	0.61	0.55	—
SMD260F	3.82	3.41	2.90	2.60	2.45	2.19	1.99	1.70	1.58	1.38	1.28	—
SMD300F	4.13	3.75	3.30	3.00	2.87	2.62	2.43	2.25	2.00	1.87	1.78	—
SMD300F/15	4.20	3.80	3.30	3.00	2.90	2.62	2.43	2.25	2.00	1.87	1.78	—
<b>SMD2 Series</b>												
<b>Size 8763 mm/3425 mils</b>												
SMD150F	2.30	2.04	1.80	1.50	1.45	1.23	1.10	0.99	0.83	0.70	0.63	—
SMD150F/33	2.30	2.04	1.80	1.50	1.45	1.23	1.10	0.99	0.83	0.70	0.63	—
SMDH160	2.14	1.96	1.78	1.60	1.56	1.42	1.33	1.24	1.15	1.06	1.02	0.44
SMD185F	2.54	2.29	2.20	1.85	1.80	1.55	1.43	1.31	1.19	1.06	1.00	—
SMD200F	3.01	2.67	2.30	2.00	1.90	1.66	1.50	1.30	1.16	0.99	0.91	—
SMD250F	3.72	3.31	2.80	2.50	2.35	2.09	1.89	1.60	1.48	1.28	1.18	—

**Figure S1 Thermal Derating Curve for Surface-mount Devices**

- A = femtoSMD / picoSMD / nanoSMD / microSMD / miniSMD / decaSMD and SMD**
- B = miniSMDE190F**
- C = SMDH120 and SMDH160**

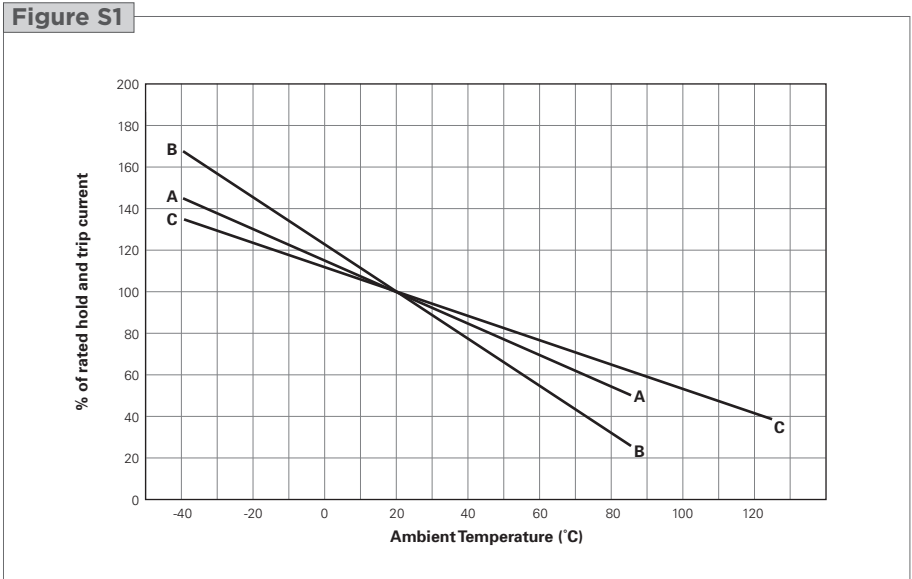

**Table S3 Electrical Characteristics for Surface-mount Devices at Room Temperature**

Part Number	I <sub>H</sub> (A)	I <sub>T</sub> (A)	V <sub>MAX</sub> (V <sub>DC</sub> )	I <sub>MAX</sub> (A)	P <sub>D MAX</sub> (W)	Max. Time-to-Trip		R <sub>MIN</sub> (Ω)	R <sub>1MAX</sub> (Ω)	Figure for Dimensions
						(A)	(S)			
<b>femtoSMDC Series</b>										
<b>Size 1608 mm/0603 mils</b>										
NEW femtoSMDC005F	0.05	0.15	15	40	0.50	0.50	0.10	3.80	30.00	S2
NEW femtoSMDC008F	0.08	0.20	12	40	0.50	0.60	0.10	2.80	14.00	S2
NEW femtoSMDC010F	0.10	0.25	12	40	0.50	0.70	0.10	1.70	8.00	S2
NEW femtoSMDC012F	0.12	0.30	9	40	0.50	0.80	0.10	1.10	5.80	S2
femtoSMDC016F	0.16	0.40	9	40	0.50	1.00	0.10	1.00	4.20	S2
NEW femtoSMDC020F	0.20	0.45	9	40	0.50	2.00	0.10	0.70	3.00	S2
NEW femtoSMDC035F	0.35	0.70	6	40	0.50	3.50	0.10	0.28	1.00	S2
<b>picoSMDC Series</b>										
<b>Size 2012 mm/0805 mils</b>										
NEW picoSMDC010S	0.10	0.30	15	100	0.50	0.50	0.60	1.50	11.00	S2
NEW picoSMDC012S	0.12	0.30	15	100	0.50	1.00	0.10	1.50	9.00	S2
picoSMDC020S	0.20	0.47	9	100	0.50	2.00	0.10	0.75	3.20	S2
picoSMDC035S	0.35	0.75	6	100	0.50	1.75	0.20	0.35	1.40	S2
NEW picoSMDC050S	0.50	1.00	6	100	0.50	8.00	0.10	0.15	0.80	S2
coming soon picoSMDC075S*	0.75	1.72	6	40	0.60	8.00	0.10	0.10	0.31	S2
coming soon picoSMDC110S*	1.10	2.10	6	40	0.60	8.00	0.20	0.05	0.16	S2
<b>nanoSMDC Series</b>										
<b>Size 3216 mm/1206 mils</b>										
nanoSMDC012F	0.12	0.39	48	10	0.50	1.00	0.20	1.40	6.50	S2
nanoSMDC016F	0.16	0.45	48	10	0.50	1.00	0.30	1.10	5.00	S2
nanoSMDC020F	0.20	0.42	24	100	0.60	8.00	0.10	0.65	3.10	S2
NEW nanoSMDC025F	0.25	0.58	16	100	0.60	8.00	0.01	0.55	2.30	S2
nanoSMDC035F	0.35	0.75	16	20	0.60	3.50	0.10	0.45	1.35	S2
nanoSMDC050F/13.2	0.50	1.10	13.2	100	0.80	8.00	0.10	0.20	0.75	S2
nanoSMDC075F	0.75	1.50	6	100	0.80	8.00	0.10	0.09	0.30	S2
nanoSMDC110F	1.10	2.20	6	100	0.80	8.00	0.10	0.07	0.20	S2
nanoSMDC150F	1.50	3.00	6	100	0.80	8.00	0.30	0.04	0.11	S2
nanoSMDC200F	2.00	4.00	6	100	1.00	8.00	1.50	0.02	0.072	S2

\* Data is preliminary

**Table S3 Electrical Characteristics for Surface-mount Devices at Room Temperature**

Cont'd

Part Number	I <sub>H</sub> (A)	I <sub>T</sub> (A)	V <sub>MAX</sub> (V <sub>DC</sub> )	I <sub>MAX</sub> (A)	P <sub>D MAX</sub> (W)	Max. Time-to-Trip		R <sub>MIN</sub> (Ω)	R <sub>1MAX</sub> (Ω)	Figure for Dimensions
						(A)	(S)			
<b>microSMD Series</b>										
<b>Size 3225 mm/1210 mils</b>										
microSMD005F	0.05	0.15	30	10	1.00	0.25	1.50	3.60	50.00	S2
microSMD010F	0.10	0.25	30	10	0.80	0.50	1.00	2.10	15.00	S2
microSMD035F	0.35	0.75	6	40	0.80	8.00	0.20	0.32	1.30	S2
microSMD050F	0.50	1.00	13.2	40	0.80	8.00	0.05	0.25	0.90	S2
microSMD075F	0.75	1.50	6	40	0.80	8.00	0.10	0.11	0.40	S2
microSMD110F	1.10	2.20	6	40	0.80	8.00	0.20	0.07	0.21	S2
microSMD150F	1.50	3.00	6	40	0.80	8.00	1.00	0.04	0.11	S2
microSMD175F	1.75	3.50	6	40	0.80	8.00	0.80	0.025	0.08	S2
microSMD200F	2.00	4.00	6	100	0.80	8.00	2.50	0.020	0.06	S2
<b>miniSMDC Series</b>										
<b>Size 4532 mm/1812 mils</b>										
miniSMDC010F	0.10	0.30	60	40	0.75	0.50	5.00	0.70	12.70	S2
miniSMDC014F	0.14	0.28	60	10	0.75	8.00	0.008	1.50	6.00	S2
miniSMDC020F	0.20	0.40	30	10	0.80	8.00	0.02	0.60	3.30	S2
miniSMDC030F	0.30	0.60	30	40	0.80	8.00	0.10	0.20	1.75	S2
miniSMDC050F	0.50	1.00	24	100	0.80	8.00	0.15	0.15	1.00	S2
miniSMDC075F	0.75	1.50	13.2	100	1.00	8.00	0.20	0.11	0.45	S2
miniSMDC075F/24	0.75	1.50	24	40	0.80	8.00	0.30	0.09	0.29	S2
miniSMDC100F	1.10	2.20	8	100	1.20	8.00	0.30	0.04	0.21	S2
miniSMDC110F	1.10	2.20	8	100	1.20	8.00	0.30	0.04	0.21	S2
miniSMDC110F/16	1.10	2.20	16	100	0.80	8.00	0.30	0.06	0.18	S2
miniSMDC110F/24	1.10	2.20	24	20	0.80	8.00	0.50	0.06	0.18	S2
miniSMDC125F	1.25	2.50	6	100	0.80	8.00	0.40	0.05	0.14	S2
miniSMDC125F/16	1.25	2.50	16	100	0.80	8.00	0.40	0.05	0.14	S2
miniSMDC150F	1.50	3.00	6	100	0.80	8.00	0.50	0.04	0.11	S2
miniSMDC150F/12	1.50	2.80	12	100	0.80	8.00	0.50	0.04	0.11	S2
miniSMDC150F/16	1.50	2.80	16	100	0.80	8.00	0.50	0.04	0.11	S2
miniSMDC150F/24	1.50	3.00	24	20	1.00	8.00	1.50	0.04	0.12	S2
miniSMDC160F	1.60	3.20	9	100	0.80	8.00	1.00	0.03	0.10	S2
miniSMDC200F	2.00	4.00	8	100	1.00	8.00	5.00	0.020	0.070	S2
miniSMDC260F	2.60	5.00	6	100	1.00	8.00	5.00	0.015	0.043	S2
miniSMDC260F/12	2.60	5.00	12	100	1.00	8.00	5.00	0.015	0.047	S2
miniSMDC260F/13.2	2.60	5.00	13.2	100	1.20	8.00	5.00	0.015	0.050	S2
miniSMDC260F/16	2.60	5.00	16	100	1.20	8.00	5.00	0.015	0.050	S2
miniSMDC300F	3.00	6.00	6	100	1.00	8.00	5.00	0.011	0.036	S2
<b>miniSMDE Series</b>										
<b>Size 11550 mm/4420 mils</b>										
miniSMDE190F	1.90	3.80	16	100	1.50	10.00	2.00	0.024	0.08	S2
<b>midSMD Series</b>										
<b>Size 5050 mm/2018 mils</b>										
SMD030F-2018	0.30	0.80	60	20	1.50	1.50	1.50	0.500	2.30	S3
decaSMDC050F/60	0.55	1.10	60	10	1.00	8.00	0.10	0.200	1.10	S2
SMD100F-2018	1.10	2.20	15	40	1.40	8.00	0.50	0.100	0.40	S3
SMD150F-2018	1.50	3.00	15	40	1.80	8.00	1.00	0.070	0.18	S3
SMD200F-2018	2.00	4.20	6	40	1.50	8.00	3.00	0.048	0.10	S3

**Table S3 Electrical Characteristics for Surface-mount Devices at Room Temperature** Cont'd

Part Number	I <sub>H</sub> (A)	I <sub>T</sub> (A)	V <sub>MAX</sub> (V <sub>DC</sub> )	I <sub>MAX</sub> (A)	P <sub>D</sub> MAX (W)	Max. Time-to-Trip		R <sub>MIN</sub> (Ω)	R <sub>1MAX</sub> (Ω)	Figure for Dimensions
						(A)	(S)			
<b>SMD Series</b>										
<b>Size 7555 mm/2920 mils</b>										
SMD030F	0.30	0.60	60	10	1.70	1.50	3.00	1.200	4.800	S4
SMD050F	0.50	1.00	60	10	1.70	2.50	4.00	0.350	1.400	S4
SMD075F	0.75	1.50	30	40	1.70	8.00	0.30	0.350	1.000	S4
SMD075F/60	0.75	1.50	60	10	1.70	8.00	0.30	0.350	1.000	S4
SMD100F	1.10	2.20	30	40	1.70	8.00	0.50	0.120	0.480	S4
SMD100F/33	1.10	2.20	33	40	1.70	8.00	0.50	0.120	0.410	S4
SMDH120	1.20	2.30	16	50	2.00	8.00	2.00	0.150	0.340	S4
SMD125F	1.25	2.50	15	40	1.70	8.00	2.00	0.070	0.250	S4
SMD260F	2.60	5.20	6	40	1.70	8.00	20.00	0.025	0.075	S4
SMD300F	3.00	6.00	6	40	1.50	8.00	35.00	0.015	0.048	S4
SMD300F/15	3.00	6.00	15	40	1.50	8.00	35.00	0.015	0.050	S4
<b>SMD2 Devices</b>										
<b>Size 8763 mm/3425 mils</b>										
SMD150F	1.50	3.00	15	40	1.90	8.00	5.00	0.060	0.250	S4
SMD150F/33	1.50	3.00	33	40	1.90	8.00	5.00	0.080	0.230	S4
SMDH160	1.60	3.20	16	70	2.20	8.00	15.00	0.050	0.150	S4
SMD185F	1.85	3.60	33	40	1.50	8.00	5.00	0.065	0.165	S4
SMD200F	2.00	4.00	15	40	1.90	8.00	12.00	0.050	0.125	S4
SMD250F	2.50	5.00	15	40	1.90	8.00	25.00	0.035	0.085	S4

**Figure S2-S4 Dimension Figures for Surface-mount Devices**

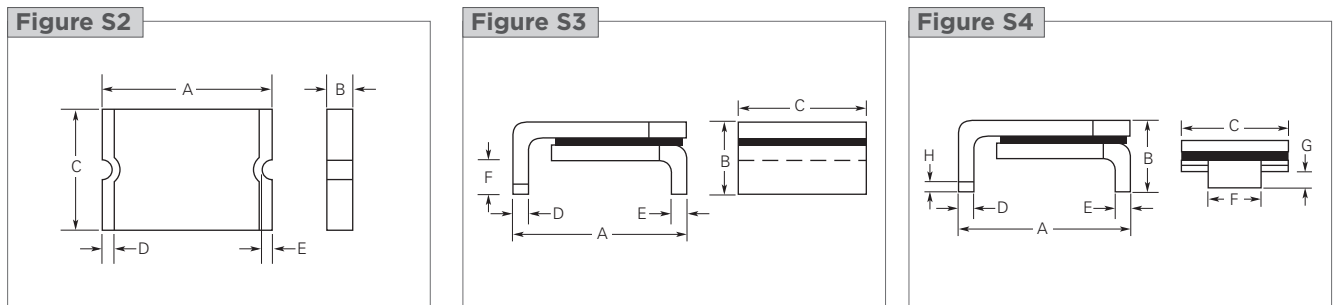

**Table S4 Dimensions for Surface-mount Devices in Millimeters (Inches)**

Part Number	A		B		C		D		E		F		G		H	Figure
	Min.	Max.	Min.	Max.	Min.	Max.	Min.	Max.	Min.	Max.	Min.	Max.	Min.	Max.	Min.	
<b>femtoSMDC Series</b>																
<b>Size 1608 mm/0603 mils</b>																
<b>NEW</b> femtoSMDC005F	1.40	1.80	0.45	0.85	0.60	1.00	0.10	0.50	0.075	—	—	—	—	—	—	S2
	(0.055)	(0.071)	(0.017)	(0.033)	(0.023)	(0.039)	(0.004)	(0.020)	(0.003)	—	—	—	—	—	—	
<b>NEW</b> femtoSMDC008F	1.40	1.80	0.45	0.85	0.60	1.00	0.10	0.50	0.075	—	—	—	—	—	—	S2
	(0.055)	(0.071)	(0.017)	(0.033)	(0.023)	(0.039)	(0.004)	(0.020)	(0.003)	—	—	—	—	—	—	
<b>NEW</b> femtoSMDC010F	1.40	1.80	0.45	0.85	0.60	1.00	0.10	0.50	0.075	—	—	—	—	—	—	S2
	(0.055)	(0.071)	(0.017)	(0.033)	(0.023)	(0.039)	(0.004)	(0.020)	(0.003)	—	—	—	—	—	—	
<b>NEW</b> femtoSMDC012F	1.40	1.80	0.35	0.75	0.60	1.00	0.10	0.50	0.075	—	—	—	—	—	—	S2
	(0.055)	(0.071)	(0.013)	(0.030)	(0.023)	(0.039)	(0.004)	(0.020)	(0.003)	—	—	—	—	—	—	
femtoSMDC016F	1.40	1.80	0.35	0.75	0.60	1.00	0.10	0.50	0.075	—	—	—	—	—	—	S2
	(0.055)	(0.071)	(0.013)	(0.030)	(0.023)	(0.039)	(0.004)	(0.020)	(0.003)	—	—	—	—	—	—	
<b>NEW</b> femtoSMDC020F	1.40	1.80	0.35	0.75	0.60	1.00	0.10	0.50	0.075	—	—	—	—	—	—	S2
	(0.055)	(0.071)	(0.013)	(0.030)	(0.023)	(0.039)	(0.004)	(0.020)	(0.003)	—	—	—	—	—	—	
<b>NEW</b> femtoSMDC035F	1.40	1.80	0.55	0.95	0.60	1.00	0.10	0.50	0.075	—	—	—	—	—	—	S2
	(0.055)	(0.071)	(0.021)	(0.037)	(0.023)	(0.039)	(0.004)	(0.020)	(0.003)	—	—	—	—	—	—	



**Table S4 Dimensions for Surface-mount Devices in Millimeters (Inches)**

Cont'd

Part Number	A		B		C		D		E		F		G		H	Figure
	Min.	Max.	Min.	Max.	Min.	Max.	Min.	Max.	Min.	Max.	Min.	Max.	Min.	Max.	Min.	
<b>picoSMDC Series</b>																
<b>Size 2012 mm/0805 mils</b>																
<b>NEW</b> picoSMDC010S	2.00 (0.079)	2.20 (0.087)	0.60 (0.023)	1.00 (0.040)	1.30 (0.051)	1.50 (0.059)	0.25 (0.010)	0.75 (0.030)	0.076 (0.003)	—	—	—	—	—	—	S2
<b>NEW</b> picoSMDC012S	2.00 (0.079)	2.20 (0.087)	0.44 (0.017)	0.68 (0.027)	1.30 (0.051)	1.50 (0.059)	0.25 (0.010)	0.75 (0.030)	0.076 (0.003)	—	—	—	—	—	—	S2
picoSMDC020S	2.00 (0.079)	2.20 (0.087)	0.44 (0.017)	0.68 (0.027)	1.30 (0.051)	1.50 (0.059)	0.25 (0.010)	0.75 (0.030)	0.076 (0.003)	—	—	—	—	—	—	S2
picoSMDC035S	2.00 (0.079)	2.20 (0.087)	0.44 (0.017)	0.68 (0.027)	1.30 (0.051)	1.50 (0.059)	0.25 (0.010)	0.75 (0.030)	0.076 (0.003)	—	—	—	—	—	—	S2
<b>NEW</b> picoSMDC050S	2.00 (0.079)	2.20 (0.087)	0.63 (0.025)	0.93 (0.036)	1.30 (0.051)	1.50 (0.059)	0.25 (0.010)	0.75 (0.030)	0.076 (0.003)	—	—	—	—	—	—	S2
<b>coming soon</b> picoSMDC075S*	2.00 (0.079)	2.20 (0.087)	0.60 (0.023)	1.00 (0.040)	1.30 (0.051)	1.50 (0.059)	0.25 (0.010)	0.75 (0.030)	0.076 (0.003)	—	—	—	—	—	—	S2
<b>coming soon</b> picoSMDC110S*	2.00 (0.079)	2.20 (0.087)	0.71 (0.028)	1.04 (0.041)	1.30 (0.051)	1.50 (0.059)	0.25 (0.010)	0.75 (0.030)	0.076 (0.003)	—	—	—	—	—	—	S2
<b>nanoSMDC Series</b>																
<b>Size 3216 mm/1206 mils</b>																
nanoSMDC012F	3.00 (0.118)	3.40 (0.134)	0.62 (0.024)	1.00 (0.039)	1.37 (0.054)	1.80 (0.071)	0.25 (0.010)	0.75 (0.030)	0.076 (0.003)	—	—	—	—	—	—	S2
nanoSMDC016F	3.00 (0.118)	3.40 (0.134)	0.62 (0.024)	1.00 (0.039)	1.37 (0.054)	1.80 (0.071)	0.25 (0.010)	0.75 (0.030)	0.076 (0.003)	—	—	—	—	—	—	S2
nanoSMDC020F	3.00 (0.118)	3.40 (0.134)	0.58 (0.023)	0.82 (0.032)	1.37 (0.054)	1.80 (0.071)	0.25 (0.010)	0.75 (0.030)	0.076 (0.003)	—	—	—	—	—	—	S2
<b>NEW</b> nanoSMDC025F	3.00 (0.118)	3.40 (0.134)	0.58 (0.023)	0.82 (0.032)	1.37 (0.054)	1.80 (0.071)	0.25 (0.010)	0.75 (0.030)	0.076 (0.003)	—	—	—	—	—	—	S2
nanoSMDC035F	3.00 (0.118)	3.40 (0.134)	0.58 (0.023)	0.82 (0.032)	1.37 (0.054)	1.80 (0.071)	0.25 (0.010)	0.75 (0.030)	0.076 (0.003)	—	—	—	—	—	—	S2
nanoSMDC050F/13.2	3.00 (0.118)	3.40 (0.134)	0.50 (0.019)	0.74 (0.029)	1.37 (0.054)	1.80 (0.071)	0.25 (0.010)	0.75 (0.030)	0.076 (0.003)	—	—	—	—	—	—	S2
nanoSMDC075F	3.00 (0.118)	3.40 (0.134)	0.44 (0.017)	0.68 (0.027)	1.37 (0.054)	1.80 (0.071)	0.25 (0.010)	0.75 (0.030)	0.076 (0.003)	—	—	—	—	—	—	S2
nanoSMDC110F	3.00 (0.118)	3.40 (0.134)	0.28 (0.011)	0.67 (0.026)	1.37 (0.054)	1.80 (0.071)	0.25 (0.010)	0.75 (0.030)	0.076 (0.003)	—	—	—	—	—	—	S2
nanoSMDC150F	3.00 (0.118)	3.40 (0.134)	0.55 (0.022)	0.89 (0.035)	1.37 (0.054)	1.80 (0.071)	0.25 (0.010)	0.75 (0.030)	0.076 (0.003)	—	—	—	—	—	—	S2
nanoSMDC200F	3.00 (0.118)	3.40 (0.134)	0.83 (0.033)	1.10 (0.043)	1.37 (0.054)	1.80 (0.071)	0.25 (0.010)	0.75 (0.030)	0.076 (0.003)	—	—	—	—	—	—	S2
<b>microSMD Series</b>																
<b>Size 3225 mm/1210 mils</b>																
microSMD005F	3.0 (0.118)	3.43 (0.135)	0.50 (0.019)	0.85 (0.034)	2.35 (0.092)	2.80 (0.110)	0.25 (0.010)	0.75 (0.030)	0.076 (0.003)	—	—	—	—	—	—	S2
microSMD010F	3.0 (0.118)	3.43 (0.135)	0.50 (0.019)	0.85 (0.034)	2.35 (0.092)	2.80 (0.110)	0.25 (0.010)	0.75 (0.030)	0.076 (0.003)	—	—	—	—	—	—	S2
microSMD035F	3.0 (0.118)	3.43 (0.135)	0.38 (0.015)	0.62 (0.025)	2.35 (0.092)	2.80 (0.110)	0.25 (0.010)	0.75 (0.030)	0.076 (0.003)	—	—	—	—	—	—	S2
microSMD050F	3.0 (0.118)	3.43 (0.135)	0.38 (0.015)	0.62 (0.025)	2.35 (0.092)	2.80 (0.110)	0.25 (0.010)	0.75 (0.030)	0.076 (0.003)	—	—	—	—	—	—	S2
microSMD075F	3.0 (0.118)	3.43 (0.135)	0.38 (0.015)	0.62 (0.025)	2.35 (0.092)	2.80 (0.110)	0.25 (0.010)	0.75 (0.030)	0.076 (0.003)	—	—	—	—	—	—	S2
microSMD110F	3.0 (0.118)	3.43 (0.135)	0.28 (0.011)	0.48 (0.019)	2.35 (0.092)	2.80 (0.110)	0.25 (0.010)	0.75 (0.030)	0.076 (0.003)	—	—	—	—	—	—	S2
microSMD150F	3.0 (0.118)	3.43 (0.135)	0.51 (0.020)	1.22 (0.048)	2.35 (0.092)	2.80 (0.110)	0.25 (0.010)	0.75 (0.030)	0.076 (0.003)	—	—	—	—	—	—	S2
microSMD175F	3.0 (0.118)	3.43 (0.135)	0.40 (0.016)	0.76 (0.030)	2.35 (0.092)	2.80 (0.110)	0.25 (0.010)	0.75 (0.030)	0.076 (0.003)	—	—	—	—	—	—	S2
microSMD200F	3.0 (0.118)	3.43 (0.135)	0.79 (0.031)	1.17 (0.046)	2.35 (0.092)	2.80 (0.110)	0.25 (0.010)	0.75 (0.030)	0.076 (0.003)	—	—	—	—	—	—	S2

**Table S4 Dimensions for Surface-mount Devices in Millimeters (Inches)**

Cont'd

Part Number	A		B		C		D		E		F		G		H	Figure
	Min.	Max.	Min.	Max.	Min.	Max.	Min.	Max.	Min.	Max.	Min.	Max.	Min.	Max.	Min.	
<b>miniSMDC Series</b>																
<b>Size 4532 mm/1812 mils</b>																
miniSMDC010F	4.37 (0.172)	4.73 (0.186)	0.635 (0.025)	0.89 (0.035)	3.07 (0.121)	3.41 (0.134)	0.25 (0.010)	0.95 (0.040)	0.20 (0.008)	—	—	—	—	—	—	S2
miniSMDC014F	4.37 (0.172)	4.73 (0.186)	0.635 (0.025)	0.89 (0.035)	3.07 (0.121)	3.41 (0.134)	0.25 (0.010)	0.95 (0.040)	0.20 (0.008)	—	—	—	—	—	—	S2
miniSMDC020F	4.37 (0.172)	4.73 (0.186)	0.635 (0.025)	0.89 (0.035)	3.07 (0.121)	3.41 (0.134)	0.25 (0.010)	0.95 (0.040)	0.20 (0.008)	—	—	—	—	—	—	S2
miniSMDC030F	4.37 (0.172)	4.73 (0.186)	0.635 (0.025)	0.89 (0.035)	3.07 (0.121)	3.41 (0.134)	0.25 (0.010)	0.95 (0.040)	0.20 (0.008)	—	—	—	—	—	—	S2
miniSMDC050F	4.37 (0.172)	4.73 (0.186)	0.38 (0.015)	0.62 (0.025)	3.07 (0.121)	3.41 (0.134)	0.25 (0.010)	0.95 (0.040)	0.20 (0.008)	—	—	—	—	—	—	S2
miniSMDC075F	4.37 (0.172)	4.73 (0.186)	0.38 (0.015)	0.62 (0.025)	3.07 (0.121)	3.41 (0.134)	0.25 (0.010)	0.95 (0.040)	0.20 (0.008)	—	—	—	—	—	—	S2
miniSMDC075F/24	4.37 (0.172)	4.83 (0.190)	0.81 (0.032)	1.46 (0.057)	3.07 (0.121)	3.41 (0.134)	0.25 (0.010)	0.95 (0.040)	0.20 (0.008)	—	—	—	—	—	—	S2
miniSMDC100F	4.37 (0.172)	4.73 (0.186)	0.38 (0.015)	0.62 (0.025)	3.07 (0.121)	3.41 (0.134)	0.25 (0.010)	0.95 (0.040)	0.20 (0.008)	—	—	—	—	—	—	S2
miniSMDC110F	4.37 (0.172)	4.73 (0.186)	0.38 (0.015)	0.62 (0.025)	3.07 (0.121)	3.41 (0.134)	0.25 (0.010)	0.95 (0.040)	0.20 (0.008)	—	—	—	—	—	—	S2
miniSMDC110F/16	4.37 (0.172)	4.83 (0.190)	0.28 (0.011)	0.48 (0.019)	3.07 (0.121)	3.41 (0.134)	0.25 (0.010)	0.95 (0.040)	0.20 (0.008)	—	—	—	—	—	—	S2
miniSMDC110F/24	4.37 (0.172)	4.83 (0.190)	0.81 (0.032)	1.46 (0.057)	3.07 (0.121)	3.41 (0.134)	0.25 (0.010)	0.95 (0.040)	0.20 (0.008)	—	—	—	—	—	—	S2
miniSMDC125F	4.37 (0.172)	4.73 (0.186)	0.28 (0.011)	0.48 (0.019)	3.07 (0.121)	3.41 (0.134)	0.25 (0.010)	0.95 (0.040)	0.20 (0.008)	—	—	—	—	—	—	S2
miniSMDC125F/16	4.37 (0.172)	4.83 (0.190)	0.28 (0.011)	0.48 (0.019)	3.07 (0.121)	3.41 (0.134)	0.25 (0.010)	0.95 (0.040)	0.20 (0.008)	—	—	—	—	—	—	S2
miniSMDC150F	4.37 (0.172)	4.73 (0.186)	0.28 (0.011)	0.48 (0.019)	3.07 (0.121)	3.41 (0.134)	0.25 (0.010)	0.95 (0.040)	0.20 (0.008)	—	—	—	—	—	—	S2
miniSMDC150F/12	4.37 (0.172)	4.83 (0.190)	0.28 (0.011)	0.48 (0.019)	3.07 (0.121)	3.41 (0.134)	0.25 (0.010)	0.95 (0.040)	0.20 (0.008)	—	—	—	—	—	—	S2
miniSMDC150F/16	4.37 (0.172)	4.83 (0.190)	0.28 (0.011)	0.48 (0.019)	3.07 (0.121)	3.41 (0.134)	0.25 (0.010)	0.95 (0.040)	0.20 (0.008)	—	—	—	—	—	—	S2
miniSMDC150F/24	4.37 (0.172)	4.83 (0.190)	1.00 (0.040)	1.94 (0.077)	3.07 (0.121)	3.41 (0.134)	0.25 (0.010)	0.95 (0.040)	0.20 (0.008)	—	—	—	—	—	—	S2
miniSMDC160F	4.37 (0.172)	4.73 (0.186)	0.28 (0.011)	0.48 (0.019)	3.07 (0.121)	3.41 (0.134)	0.25 (0.010)	0.95 (0.040)	0.20 (0.008)	—	—	—	—	—	—	S2
miniSMDC200F	4.37 (0.172)	4.73 (0.186)	0.51 (0.020)	1.22 (0.048)	3.07 (0.121)	3.41 (0.134)	0.25 (0.010)	0.95 (0.040)	0.20 (0.008)	—	—	—	—	—	—	S2
miniSMDC260F	4.37 (0.172)	4.73 (0.186)	0.48 (0.019)	0.78 (0.031)	3.07 (0.121)	3.41 (0.134)	0.25 (0.010)	0.95 (0.040)	0.20 (0.008)	—	—	—	—	—	—	S2
miniSMDC260F/12	4.37 (0.172)	4.83 (0.190)	1.02 (0.042)	1.52 (0.060)	3.07 (0.121)	3.41 (0.134)	0.25 (0.010)	0.95 (0.040)	0.20 (0.008)	—	—	—	—	—	—	S2
miniSMDC260F/13.2	4.37 (0.172)	4.83 (0.190)	1.02 (0.042)	1.52 (0.060)	3.07 (0.121)	3.41 (0.134)	0.25 (0.010)	0.95 (0.040)	0.20 (0.008)	—	—	—	—	—	—	S2
miniSMDC260F/16	4.37 (0.172)	4.83 (0.190)	1.02 (0.042)	1.52 (0.060)	3.07 (0.121)	3.41 (0.134)	0.25 (0.010)	0.95 (0.040)	0.20 (0.008)	—	—	—	—	—	—	S2
miniSMDC300F	4.37 (0.172)	4.73 (0.186)	0.45 (0.018)	0.76 (0.030)	3.07 (0.121)	3.41 (0.134)	0.25 (0.010)	0.95 (0.040)	0.20 (0.008)	—	—	—	—	—	—	S2
<b>miniSMDE Series</b>																
<b>Size 11550 mm/4420 mils</b>																
miniSMDE190F	11.15 (0.439)	11.51 (0.453)	0.33 (0.013)	0.53 (0.021)	4.83 (0.190)	5.33 (0.210)	0.51 (0.020)	1.02 (0.040)	0.381 (0.015)	—	—	—	—	—	—	S2

**Table S4 Dimensions for Surface-mount Devices in Millimeters (Inches)**

Cont'd

Part Number	A		B		C		D		E		F		G		H	Figure
	Min.	Max.	Min.	Max.	Min.	Max.	Min.	Max.	Min.	Max.	Min.	Max.	Min.	Max.	Min.	
<b>midSMD Series</b>																
<b>Size 5050 mm/2018 mils</b>																
SMD030F-2018	4.72 (0.186)	5.44 (0.214)	—	1.78 (0.070)	4.22 (0.166)	4.93 (0.194)	0.25 (0.010)	0.36 (0.014)	0.25 (0.010)	0.36 (0.014)	0.30 (0.012)	0.46 (0.018)	—	—	—	S3
decaSMDC050F/60	4.70 (0.185)	5.31 (0.209)	0.63 (0.025)	0.89 (0.035)	4.19 (0.165)	4.81 (0.189)	0.25 (0.010)	0.95 (0.040)	0.25 (0.010)	—	—	—	—	—	—	S2
SMD100F-2018	4.72 (0.186)	5.44 (0.214)	—	1.52 (0.060)	4.22 (0.166)	4.93 (0.194)	0.25 (0.010)	0.36 (0.014)	0.25 (0.010)	0.36 (0.014)	0.30 (0.012)	0.46 (0.018)	—	—	—	S3
SMD150F-2018	4.72 (0.186)	5.44 (0.214)	—	1.52 (0.060)	4.22 (0.166)	4.93 (0.194)	0.25 (0.010)	0.36 (0.014)	0.25 (0.010)	0.36 (0.014)	0.30 (0.012)	0.46 (0.018)	—	—	—	S3
SMD200F-2018	4.72 (0.186)	5.44 (0.214)	—	1.52 (0.060)	4.22 (0.166)	4.93 (0.194)	0.25 (0.010)	0.36 (0.014)	0.25 (0.010)	0.36 (0.014)	0.30 (0.012)	0.46 (0.018)	—	—	—	S3
<b>SMD Series</b>																
<b>Size 7555 mm/2920 mils</b>																
SMD030F	6.73 (0.265)	7.98 (0.314)	—	3.18 (0.125)	4.80 (0.19)	5.44 (0.214)	0.56 (0.022)	0.71 (0.028)	0.56 (0.022)	0.71 (0.028)	2.16 (0.085)	2.41 (0.095)	0.66 (0.026)	1.37 (0.054)	0.43 (0.017)	S4
SMD050F	6.73 (0.265)	7.98 (0.314)	—	3.18 (0.125)	4.80 (0.19)	5.44 (0.214)	0.56 (0.022)	0.71 (0.028)	0.56 (0.022)	0.71 (0.028)	2.16 (0.085)	2.41 (0.095)	0.66 (0.026)	1.37 (0.054)	0.43 (0.017)	S4
SMD075F	6.73 (0.265)	7.98 (0.314)	—	3.18 (0.125)	4.80 (0.19)	5.44 (0.214)	0.56 (0.022)	0.71 (0.028)	0.56 (0.022)	0.71 (0.028)	2.16 (0.085)	2.41 (0.095)	0.66 (0.026)	1.37 (0.054)	0.43 (0.017)	S4
SMD075F/60	6.73 (0.265)	7.98 (0.314)	—	3.18 (0.125)	4.80 (0.19)	5.44 (0.214)	0.56 (0.022)	0.71 (0.028)	0.56 (0.022)	0.71 (0.028)	2.16 (0.085)	2.41 (0.095)	0.66 (0.026)	1.37 (0.054)	0.43 (0.017)	S4
SMD100F	6.73 (0.265)	7.98 (0.314)	—	3.00 (0.118)	4.80 (0.19)	5.44 (0.214)	0.56 (0.022)	0.71 (0.028)	0.56 (0.022)	0.71 (0.028)	2.16 (0.085)	2.41 (0.095)	0.66 (0.026)	1.37 (0.054)	0.43 (0.017)	S4
SMD100F/33	6.73 (0.265)	7.98 (0.314)	—	3.00 (0.118)	4.80 (0.19)	5.44 (0.214)	0.56 (0.022)	0.71 (0.028)	0.56 (0.022)	0.71 (0.028)	2.16 (0.085)	2.41 (0.095)	0.66 (0.026)	1.37 (0.054)	0.43 (0.017)	S4
SMDH120	6.73 (0.265)	7.98 (0.314)	—	3.00 (0.118)	4.80 (0.19)	5.44 (0.214)	0.56 (0.022)	0.71 (0.028)	0.56 (0.022)	0.71 (0.028)	2.16 (0.085)	2.41 (0.095)	0.66 (0.026)	1.37 (0.054)	0.43 (0.017)	S4
SMD125F	6.73 (0.265)	7.98 (0.314)	—	3.00 (0.118)	4.80 (0.19)	5.44 (0.214)	0.56 (0.022)	0.71 (0.028)	0.56 (0.022)	0.71 (0.028)	2.16 (0.085)	2.41 (0.095)	0.66 (0.026)	1.37 (0.054)	0.43 (0.017)	S4
SMD260F	6.73 (0.265)	7.98 (0.314)	—	3.00 (0.118)	4.80 (0.19)	5.44 (0.214)	0.56 (0.022)	0.71 (0.028)	0.56 (0.022)	0.71 (0.028)	2.16 (0.085)	2.41 (0.095)	0.66 (0.026)	1.37 (0.054)	0.43 (0.017)	S4
SMD300F	6.73 (0.265)	7.98 (0.314)	—	3.00 (0.118)	4.80 (0.19)	5.44 (0.214)	0.56 (0.022)	0.71 (0.028)	0.56 (0.022)	0.71 (0.028)	2.16 (0.085)	2.41 (0.095)	0.66 (0.026)	1.37 (0.054)	0.43 (0.017)	S4
SMD300F/15	6.73 (0.265)	7.98 (0.314)	—	3.00 (0.118)	4.80 (0.19)	5.44 (0.214)	0.56 (0.022)	0.71 (0.028)	0.56 (0.022)	0.71 (0.028)	2.16 (0.085)	2.41 (0.095)	0.66 (0.026)	1.37 (0.054)	0.43 (0.017)	S4
<b>SMD2 Devices</b>																
<b>Size 8763 mm/3425 mils</b>																
SMD150F	8.00 (0.315)	9.40 (0.370)	—	3.00 (0.118)	6.00 (0.236)	6.71 (0.264)	0.56 (0.022)	0.71 (0.028)	0.56 (0.022)	0.71 (0.028)	3.68 (0.145)	3.94 (0.155)	0.66 (0.026)	1.37 (0.054)	0.43 (0.017)	S4
SMD150F/33	8.00 (0.315)	9.40 (0.370)	—	3.00 (0.118)	6.00 (0.236)	6.71 (0.264)	0.56 (0.022)	0.71 (0.028)	0.56 (0.022)	0.71 (0.028)	3.68 (0.145)	3.94 (0.155)	0.66 (0.026)	1.37 (0.054)	0.43 (0.017)	S4
SMDH160	8.00 (0.315)	9.40 (0.370)	—	3.00 (0.118)	6.00 (0.236)	6.71 (0.264)	0.56 (0.022)	0.71 (0.028)	0.56 (0.022)	0.71 (0.028)	3.68 (0.145)	3.94 (0.155)	0.66 (0.026)	1.37 (0.054)	0.43 (0.017)	S4
SMD185F	8.00 (0.315)	9.40 (0.370)	—	3.00 (0.118)	6.00 (0.236)	6.71 (0.264)	0.56 (0.022)	0.71 (0.028)	0.56 (0.022)	0.71 (0.028)	3.68 (0.145)	3.94 (0.155)	0.66 (0.026)	1.37 (0.054)	0.43 (0.017)	S4
SMD200F	8.00 (0.315)	9.40 (0.370)	—	3.00 (0.118)	6.00 (0.236)	6.71 (0.264)	0.56 (0.022)	0.71 (0.028)	0.56 (0.022)	0.71 (0.028)	3.68 (0.145)	3.94 (0.155)	0.66 (0.026)	1.37 (0.054)	0.43 (0.017)	S4
SMD250F	8.00 (0.315)	9.40 (0.370)	—	3.00 (0.118)	6.00 (0.236)	6.71 (0.264)	0.56 (0.022)	0.71 (0.028)	0.56 (0.022)	0.71 (0.028)	3.68 (0.145)	3.94 (0.155)	0.66 (0.026)	1.37 (0.054)	0.43 (0.017)	S4

**Figure S5-S12** Typical Time-to-trip Curves at 20°C for Surface-mount Devices

**femtoSMDCxxxF**

- A = femtoSMDC005F
- B = femtoSMDC008F
- C = femtoSMDC010F
- D = femtoSMDC012F
- E = femtoSMDC016F
- F = femtoSMDC020F
- G = femtoSMDC035F

**Figure S5**

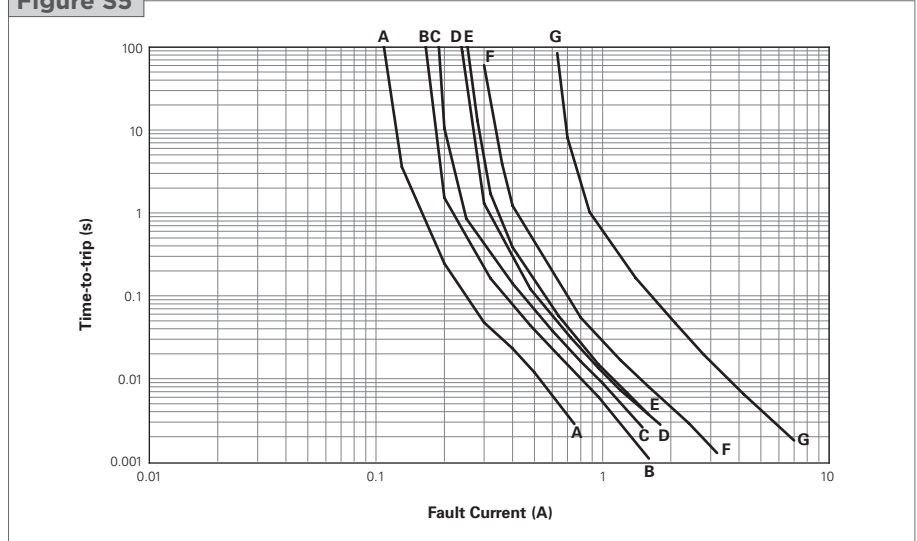

**picoSMDCxxxS**

- A = picoSMDC010S
- B = picoSMDC012S
- C = picoSMDC020S
- D = picoSMDC035S
- E = picoSMDC050S
- F = picoSMDC075S\*
- G = picoSMDC110S\*

\* Data is preliminary

**Figure S6**

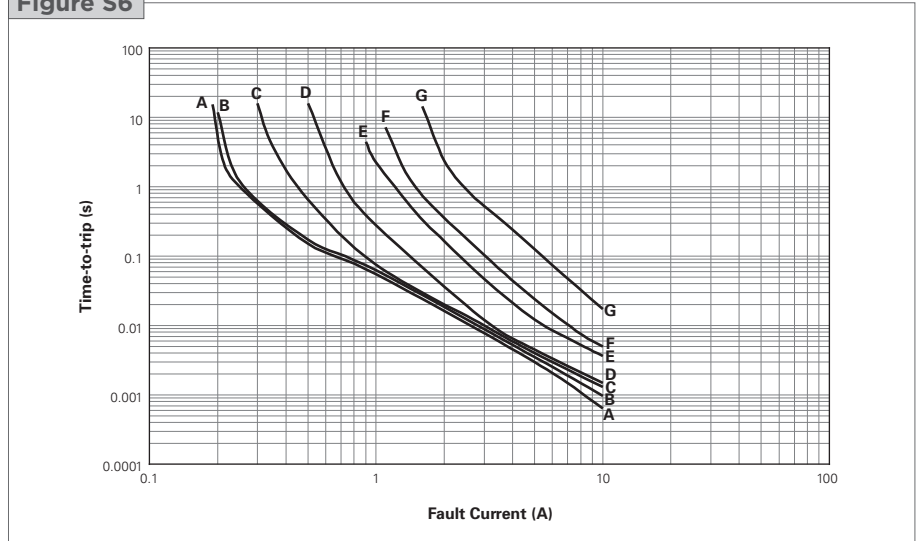

**nanoSMDCxxxF**

- A = nanoSMDC012F
- B = nanoSMDC016F
- C = nanoSMDC020F
- D = nanoSMDC025F
- E = nanoSMDC035F
- F = nanoSMDC050F/13.2
- G = nanoSMDC075F
- H = nanoSMDC110F
- I = nanoSMDC150F
- J = nanoSMDC200F

**Figure S7**

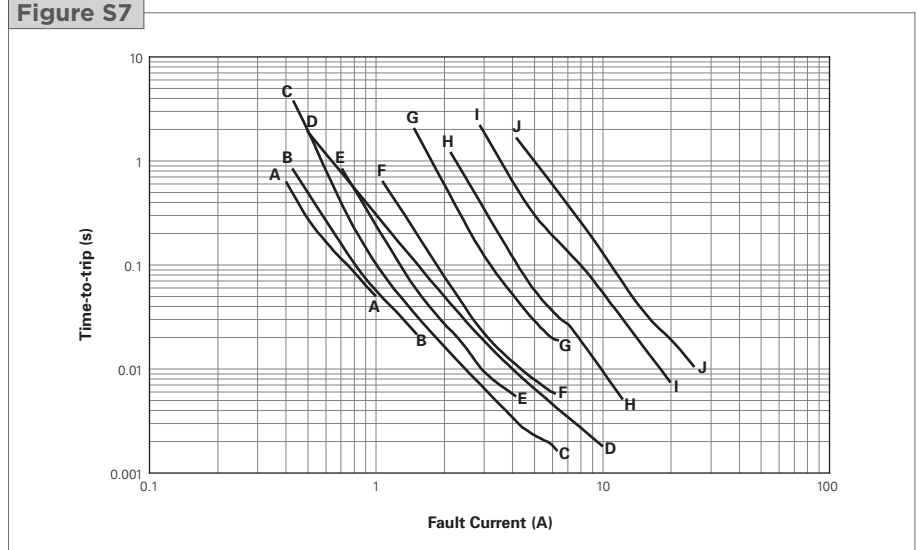
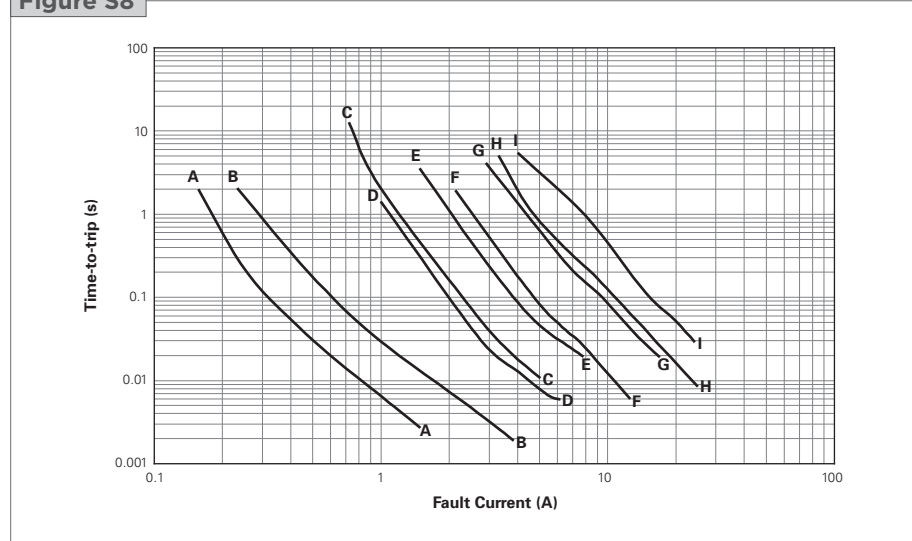

**Figure S5-S12 Typical Time-to-trip Curves at 20°C for Surface-mount Devices**

Cont'd

**microSMDxxxF**

- A = microSMD005F
- B = microSMD010F
- C = microSMD035F
- D = microSMD050F
- E = microSMD075F
- F = microSMD110F
- G = microSMD150F
- H = microSMD175F
- I = microSMD200F

**Figure S8**

**miniSMDCxxxF and miniSMDExxxF**

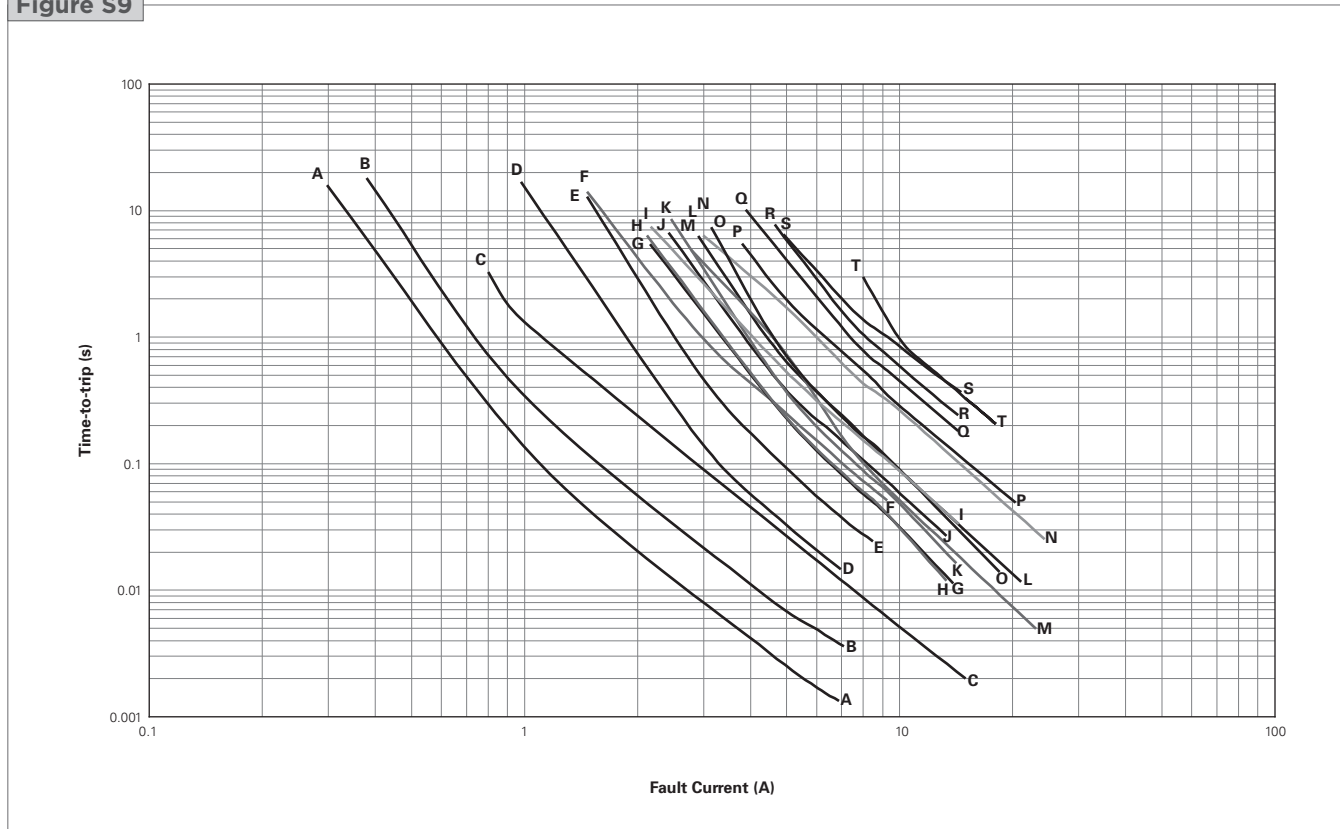
- |                                |                                   |   |
|--------------------------------|-----------------------------------|---|
| A = miniSMDC010F, miniSMDC014F | H = miniSMDC110F/16               | O = miniSMDC160F  |
| B = miniSMDC020F               | I = miniSMDC110F/24               | P = miniSMDE190F  |
| C = miniSMDC030F               | J = miniSMDC125F                  | Q = miniSMDC200F  |
| D = miniSMDC050F               | K = miniSMDC125F/16               | R = miniSMDC260F  |
| E = miniSMDC075F               | L = miniSMDC150F, miniSMDC150F/12 | S = miniSMDC260F/12, miniSMDC260F/13.2, miniSMDC260F/16 |
| F = miniSMDC075F/24            | M = miniSMDC150F/16               | T = miniSMDC300F  |
| G = miniSMDC100F, miniSMDC110F | N = miniSMDC150F/24               |   |

**Figure S9**

**midSMD**

- A = SMD030F-2018
- B = decaSMD050F/60
- C = SMD100F-2018
- D = SMD150F-2018
- E = SMD200F-2018

**Figure S10**

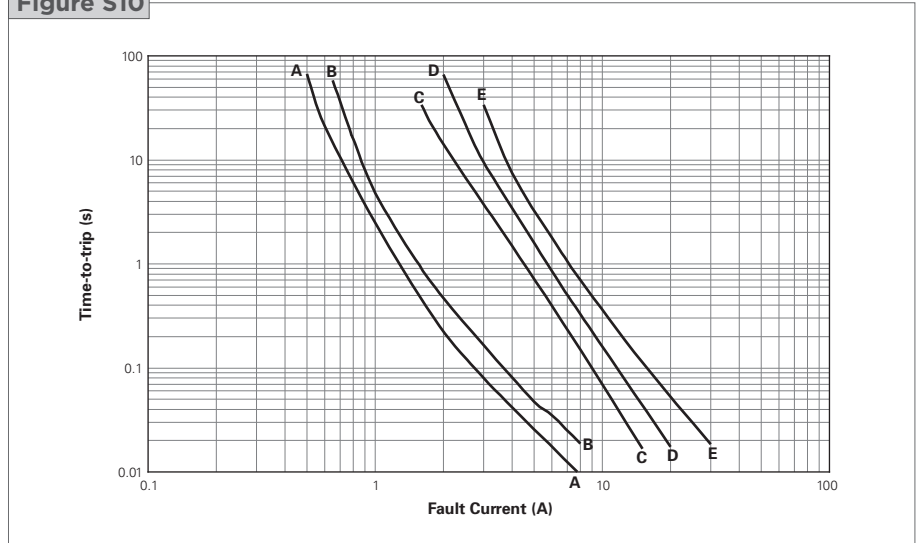

**SMDxxxF**

- A = SMD030F
- B = SMD050F
- C = SMD075F, SMD075F/60
- D = SMD100F, SMD100F/33
- E = SMDH120
- F = SMD125F
- G = SMD260F
- H = SMD300F, SMD300F/15

**Figure S11**

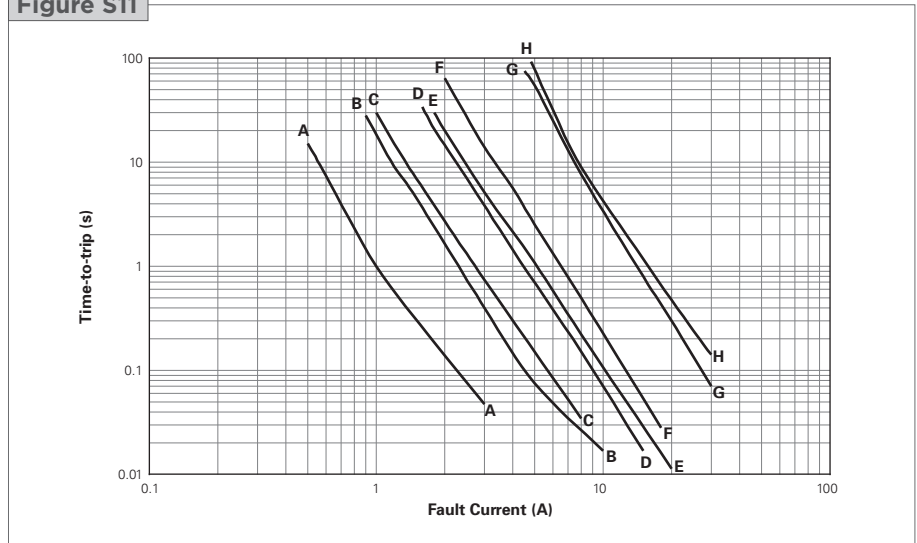

**SMD2xxxF**

- A = SMD150F, SMD150F/33
- B = SMDH160
- C = SMD185F
- D = SMD200F
- E = SMD250F

**Figure S12**

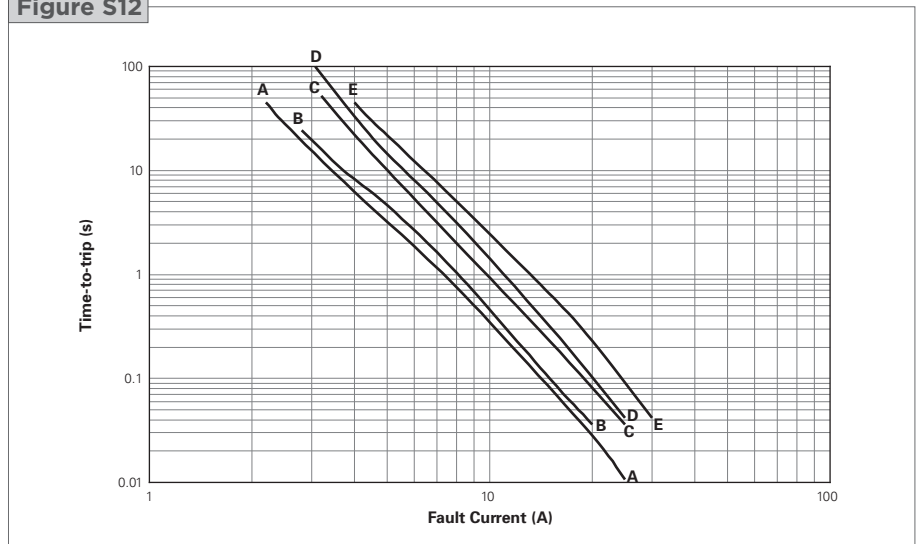

**Table S5 Physical Characteristics and Environmental Specifications for Surface-mount Devices**  
 Operating temperature range -40°C to 85°C, -40°C to 125°C for SMDH120 and SMDH160

**Physical Characteristics**

Terminal pad material	100% matte tin with nickel underplate
Soldering characteristics	ANSI/J-STD-002 Category 3 for femtoSMD, picoSMD, nanoSMD, microSMD and miniSMD series ANSI/J-STD-002 Category 1 for SMD series
Solder heat withstand	per IEC-STD 68-2-20, Test Tb, Section 5, Method 1A
Flammability resistance	per IEC 695-2-2 Needle Flame Test for 20 sec.
Recommended storage conditions	40°C max, 70% R.H. max; devices may not meet specified ratings if storage conditions are exceeded.

**Environmental Specifications**

Test	Test Method	Conditions	Resistance Change
Storage life	Raychem PS300, Section 5.3.2	60°C, 1000 hours	±3% typical
		85°C, 1000 hours	±5% typical
Humidity aging	Raychem PS300, Section 5.3.1	85°C, 85% RH, 100 hours	±1.2% typical
Thermal shock	MIL-STD-202, Method 107G	85°C, -40°C (20 times)	-33% typical
		125°C, -55°C (10 times)	-33% typical
Vibration	MIL-STD-883C	per MIL-STD-883C	No change
Solvent resistance	Raychem PS300, Section 5.2.2	Freon	No change
		Trichloroethane	No change
		Hydrocarbons	No change

**Table S6 Packaging and Marking Information for Surface-mount Devices**

Part Number	Tape & Reel Quantity	Standard Package	Part Marking	Recommended Pad Layout Figures [mm(In.)]			Agency Recognition
				Dimension A (Nom.)	Dimension B (Nom.)	Dimension C (Nom.)	
<b>femtoSMDC Series</b>							
<b>Size 1608 mm/0603 mils</b>							
NEW femtoSMDC005F	4,000	20,000	A	0.80 (0.032)	0.60 (0.024)	0.80 (0.032)	UL, CSA
NEW femtoSMDC008F	4,000	20,000	T	0.80 (0.032)	0.60 (0.024)	0.80 (0.032)	UL, CSA
NEW femtoSMDC010F	4,000	20,000	B	0.80 (0.032)	0.60 (0.024)	0.80 (0.032)	UL, CSA
NEW femtoSMDC012F	4,000	20,000	C	0.80 (0.032)	0.60 (0.024)	0.80 (0.032)	UL, CSA
femtoSMDC016F	4,000	20,000	E	0.80 (0.032)	0.60 (0.024)	0.80 (0.032)	UL, CSA
NEW femtoSMDC020F	4,000	20,000	F	0.80 (0.032)	0.60 (0.024)	0.80 (0.032)	UL, CSA
NEW femtoSMDC035F	4,000	20,000	K	0.80 (0.032)	0.60 (0.024)	0.80 (0.032)	UL, CSA
<b>picoSMDC Series</b>							
<b>Size 2012 mm/0805 mils</b>							
NEW picoSMDC010S	3,000	15,000	C	1.50 (0.060)	1.00 (0.039)	1.20 (0.047)	UL
NEW picoSMDC012S	4,000	20,000	F	1.50 (0.060)	1.00 (0.039)	1.20 (0.047)	UL, CSA
picoSMDC020S	4,000	20,000	H	1.50 (0.060)	1.00 (0.039)	1.20 (0.047)	UL, CSA
picoSMDC035S	4,000	20,000	I	1.50 (0.060)	1.00 (0.039)	1.20 (0.047)	UL, CSA
NEW picoSMDC050S	3,000	15,000	K	1.50 (0.060)	1.00 (0.039)	1.20 (0.047)	UL, CSA
coming soon picoSMDC075S*	3,000	15,000	M	1.50 (0.060)	1.00 (0.039)	1.20 (0.047)	Pending
coming soon picoSMDC110S*	3,000	15,000	S	1.50 (0.060)	1.00 (0.039)	1.20 (0.047)	Pending
<b>nanoSMDC Series</b>							
<b>Size 3216 mm/1206 mils</b>							
nanoSMDC012F	3,000	15,000	P	1.60 (0.063)	1.00 (0.039)	2.00 (0.079)	UL, CSA, TÜV
nanoSMDC016F	3,000	15,000	N	1.60 (0.063)	1.00 (0.039)	2.00 (0.079)	UL, CSA, TÜV
nanoSMDC020F	3,000	15,000	02	1.60 (0.063)	1.00 (0.039)	2.00 (0.079)	UL, CSA, TÜV
NEW nanoSMDC025F	3,000	15,000	C	1.60 (0.063)	1.00 (0.039)	2.00 (0.079)	UL, CSA
nanoSMDC035F	3,000	15,000	03	1.60 (0.063)	1.00 (0.039)	2.00 (0.079)	UL, CSA, TÜV
nanoSMDC050F/13.2	3,000	15,000	M	1.60 (0.063)	1.00 (0.039)	2.00 (0.079)	UL, CSA, TÜV
nanoSMDC075F	3,000	15,000	L	1.60 (0.063)	1.00 (0.039)	2.00 (0.079)	UL, CSA, TÜV
nanoSMDC110F	3,000	15,000	K	1.60 (0.063)	1.00 (0.039)	2.00 (0.079)	UL, CSA, TÜV
nanoSMDC150F	3,000	15,000	15	1.60 (0.063)	1.00 (0.039)	2.00 (0.079)	UL, CSA, TÜV
nanoSMDC200F	3,000	15,000	T	1.60 (0.063)	1.00 (0.039)	2.00 (0.079)	UL, CSA, TÜV

\* Data is preliminary

**Table S6 Packaging and Marking Information for Surface-mount Devices**

Cont'd

Part Number	Tape & Reel Quantity	Standard Package	Part Marking	Recommended Pad Layout Figures [mm(In.)]			Agency Recognition
				Dimension A (Nom.)	Dimension B (Nom.)	Dimension C (Nom.)	
<b>microSMD Series</b>							
<b>Size 3225 mm/1210 mils</b>							
microSMD005F	4,000	20,000	05	2.50 (0.098)	1.00 (0.039)	2.00 (0.079)	UL, CSA, TÜV
microSMD010F	4,000	20,000	10	2.50 (0.098)	1.00 (0.039)	2.00 (0.079)	UL, CSA, TÜV
microSMD035F	4,000	20,000	3	2.50 (0.098)	1.00 (0.039)	2.00 (0.079)	UL, CSA, TÜV
microSMD050F	4,000	20,000	50	2.50 (0.098)	1.00 (0.039)	2.00 (0.079)	UL, CSA, TÜV
microSMD075F	4,000	20,000	75	2.50 (0.098)	1.00 (0.039)	2.00 (0.079)	UL, CSA, TÜV
microSMD110F	4,000	20,000	11	2.50 (0.098)	1.00 (0.039)	2.00 (0.079)	UL, CSA, TÜV
microSMD150F	4,000	20,000	15	2.50 (0.098)	1.00 (0.039)	2.00 (0.079)	UL, CSA, TÜV
microSMD175F	4,000	20,000	17	2.50 (0.098)	1.00 (0.039)	2.00 (0.079)	UL, CSA, TÜV
microSMD200F	3,000	15,000	20	2.50 (0.098)	1.00 (0.039)	2.00 (0.079)	UL, CSA, TÜV
<b>miniSMDC Series</b>							
<b>Size 4532 mm/1812 mils</b>							
miniSMDC010F	2,000	10,000	10	3.15 (0.124)	1.68 (0.066)	3.10 (0.122)	UL, CSA
miniSMDC014F	2,000	10,000	14	3.15 (0.124)	1.68 (0.066)	3.10 (0.122)	UL, CSA, TÜV
miniSMDC020F	2,000	10,000	2	3.15 (0.124)	1.68 (0.066)	3.10 (0.122)	UL, CSA, TÜV
miniSMDC030F	2,000	10,000	3	3.15 (0.124)	1.68 (0.066)	3.10 (0.122)	UL, CSA
miniSMDC050F	2,000	10,000	5	3.15 (0.124)	1.68 (0.066)	3.10 (0.122)	UL, CSA, TÜV
miniSMDC075F	2,000	10,000	7	3.15 (0.124)	1.68 (0.066)	3.10 (0.122)	UL, CSA, TÜV
miniSMDC075F/24	1,500	7,500	075F 24V	3.15 (0.124)	1.68 (0.066)	3.10 (0.122)	UL, CSA, TÜV
miniSMDC100F	2,000	10,000	1	3.15 (0.124)	1.68 (0.066)	3.10 (0.122)	UL, CSA, TÜV
miniSMDC110F	2,000	10,000	1	3.15 (0.124)	1.68 (0.066)	3.10 (0.122)	UL, CSA, TÜV
miniSMDC110F/16	2,000	10,000	110F 16V	3.15 (0.124)	1.68 (0.066)	3.10 (0.122)	UL, CSA, TÜV
miniSMDC110F/24	1,500	7,500	110F 24V	3.15 (0.124)	1.68 (0.066)	3.10 (0.122)	UL, CSA, TÜV
miniSMDC125F	2,000	10,000	12	3.15 (0.124)	1.68 (0.066)	3.10 (0.122)	UL, CSA, TÜV
miniSMDC125F/16	2,000	10,000	125F 16V	3.15 (0.124)	1.68 (0.066)	3.10 (0.122)	UL, CSA, TÜV
miniSMDC150F	2,000	10,000	15	3.15 (0.124)	1.68 (0.066)	3.10 (0.122)	UL, CSA, TÜV
miniSMDC150F/12	2,000	10,000	150F 12V	3.15 (0.124)	1.68 (0.066)	3.10 (0.122)	UL, CSA, TÜV
miniSMDC150F/16	2,000	10,000	150 16V	3.15 (0.124)	1.68 (0.066)	3.10 (0.122)	UL, CSA, TÜV
miniSMDC150F/24	1,000	5,000	150F 24V	3.15 (0.124)	1.68 (0.066)	3.10 (0.122)	UL, CSA, TÜV
miniSMDC160F	2,000	10,000	16	3.15 (0.124)	1.68 (0.066)	3.10 (0.122)	UL, CSA, TÜV
miniSMDC200F	2,000	10,000	20	3.15 (0.124)	1.68 (0.066)	3.10 (0.122)	UL, CSA, TÜV
miniSMDC260F	2,000	10,000	260F	3.15 (0.124)	1.68 (0.066)	3.10 (0.122)	UL, CSA, TÜV
miniSMDC260F/12	1,500	7,500	260F 12V	3.15 (0.124)	1.68 (0.066)	3.10 (0.122)	UL, CSA, TÜV
miniSMDC260F/13.2	1,500	7,500	260F 13V	3.15 (0.124)	1.68 (0.066)	3.10 (0.122)	UL, CSA, TÜV
miniSMDC260F/16	1,500	7,500	260F 16V	3.15 (0.124)	1.68 (0.066)	3.10 (0.122)	UL, CSA, TÜV
miniSMDC300F	2,000	10,000	30	3.15 (0.124)	1.68 (0.066)	3.10 (0.122)	UL, CSA
<b>miniSMDE Series</b>							
<b>Size 11550 mm/4420 mils</b>							
miniSMDE190F	5,000	20,000	19	4.75 (0.187)	1.45 (0.057)	9.57 (0.377)	UL, CSA, TÜV
<b>midSMD Series</b>							
<b>Size 5050 mm/2018 mils</b>							
SMD030F-2018	4,000	20,000	A03F	4.60 (0.18)	1.50 (0.059)	3.40 (0.134)	UL, CSA, TÜV
decaSMDC050F/60	1,000	5,000	050F 60V	4.32 (0.17)	1.40 (0.055)	3.61 (0.142)	UL, CSA, TÜV
SMD100F-2018	4,000	20,000	A10F	4.60 (0.18)	1.50 (0.059)	3.40 (0.134)	UL, CSA, TÜV
SMD150F-2018	4,000	20,000	A15F	4.60 (0.18)	1.50 (0.059)	3.40 (0.134)	UL, CSA, TÜV
SMD200F-2018	4,000	20,000	A20F	4.60 (0.18)	1.50 (0.059)	3.40 (0.134)	UL, CSA, TÜV



**Table S6 Packaging and Marking Information for Surface-mount Devices** Cont'd

Part Number	Tape & Reel Quantity	Standard Package	Part Marking	Recommended Pad Layout Figures [mm(In.)]			Agency Recognition
				Dimension A (Nom.)	Dimension B (Nom.)	Dimension C (Nom.)	
<b>SMD Series</b>							
<b>Size 7555 mm/2920 mils</b>							
SMD030F	2,000	10,000	030F	3.10 (0.12)	2.30 (0.09)	5.10 (0.201)	UL, CSA, TÜV
SMD050F	2,000	10,000	050F	3.10 (0.12)	2.30 (0.09)	5.10 (0.201)	UL, CSA, TÜV
SMD075F	2,000	10,000	075F	3.10 (0.12)	2.30 (0.09)	5.10 (0.201)	UL, CSA, TÜV
SMD075F/60	2,000	10,000	756F	3.10 (0.12)	2.30 (0.09)	5.10 (0.201)	UL, CSA, TÜV
SMD100F	2,000	10,000	100F	3.10 (0.12)	2.30 (0.09)	5.10 (0.201)	UL, CSA, TÜV
SMD100F/33	2,000	10,000	103F	3.10 (0.12)	2.30 (0.09)	5.10 (0.201)	UL, CSA, TÜV
SMDH120	2,000	10,000	H12	3.10 (0.12)	2.30 (0.09)	5.10 (0.201)	UL, CSA, TÜV
SMD125F	2,000	10,000	125F	3.10 (0.12)	2.30 (0.09)	5.10 (0.201)	UL, CSA, TÜV
SMD260F	2,000	10,000	260F	3.10 (0.12)	2.30 (0.09)	5.10 (0.201)	UL, CSA, TÜV
SMD300F	2,000	10,000	300F	3.10 (0.12)	2.30 (0.09)	5.10 (0.201)	UL, CSA, TÜV
SMD300F/15	2,000	10,000	315F	3.10 (0.12)	2.30 (0.09)	5.10 (0.201)	UL, CSA
<b>SMD2 Devices</b>							
<b>Size 8763 mm/3425 mils</b>							
SMD150F	1,500	7,500	150F	4.60 (0.18)	2.30 (0.09)	6.10 (0.240)	UL, CSA, TÜV
SMD150F/33	1,500	7,500	153F	4.60 (0.18)	2.30 (0.09)	6.10 (0.240)	UL, CSA, TÜV
SMDH160	1,500	7,500	160F	4.60 (0.18)	2.30 (0.09)	6.10 (0.240)	UL, CSA, TÜV
SMD185F	1,500	7,500	185F	4.60 (0.18)	2.30 (0.09)	6.10 (0.240)	UL, CSA, TÜV
SMD200F	1,500	7,500	200F	4.60 (0.18)	2.30 (0.09)	6.10 (0.240)	UL, CSA, TÜV
SMD250F	1,500	7,500	250F	4.60 (0.18)	2.30 (0.09)	6.10 (0.240)	UL, CSA, TÜV

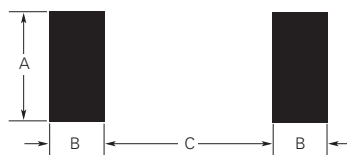
**Figure S13 Recommended Pad Layout for Surface-mount Devices**

**Agency Recognition for Surface-mount Devices**

UL	File # E74889 for all surface-mount devices
CSA	File # CA78165 for all surface-mount devices
TÜV	Certificate number available upon request (certified to IEC 60730-1)

## Solder Reflow and Rework Recommendation for Surface-mount Devices

### Classification Reflow Profiles

Profile Feature	Pb-Free Assembly
<b>Average ramp up rate (Ts<sub>MAX</sub> to Tp)</b>	3°C/second max.
<b>Preheat</b>	
• Temperature min. (Ts <sub>MIN</sub> )	150°C
• Temperature max. (Ts <sub>MAX</sub> )	200°C
• Time (ts <sub>MIN</sub> to ts <sub>MAX</sub> )	60-120 seconds
<b>Time maintained above:</b>	
• Temperature (T <sub>L</sub> )	217°C
• Time (t <sub>L</sub> )	60-150 seconds
<b>Peak/Classification temperature (Tp)</b>	260°C
<b>Time within 5°C of actual peak temperature</b>	
Time (tp)	30 seconds max.
<b>Ramp down rate</b>	3°C/second max.
<b>Time 25°C to peak temperature</b>	8 minutes max.

**Note:** All temperatures refer to topside of the package, measured on the package body surface.

Figure S14

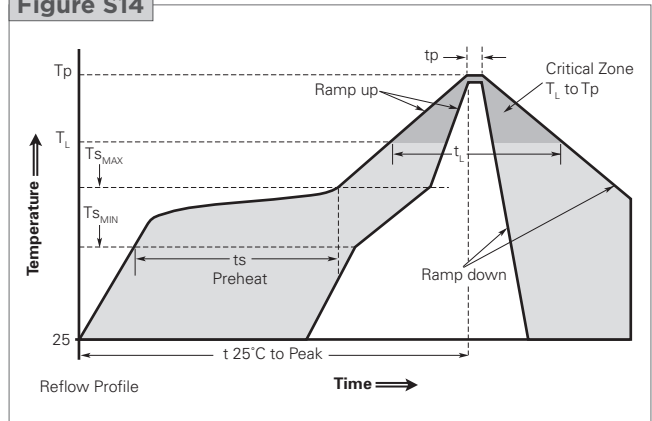

### Solder Reflow

- Recommended reflow methods:
  - IR
  - Hot air
  - Nitrogen
- Recommended maximum paste thickness: 0.25mm (0.010 inch)
- Devices can be cleaned using standard methods and aqueous solvents.
- We believe the optimum conditions for forming acceptable solder fillets occur when a reasonable amount of solder paste is placed underneath each device's termination. As such, we request that customers comply with our recommended solder pad layouts.
- Customer should validate that the solder paste amount and reflow recommendations meet its application.
- We request that customer board layouts refrain from placing raised features (e.g. vias, nomenclature, traces, etc.) underneath PolySwitch devices. It is possible that raised features could negatively impact solderability performance of our devices.

### Rework

- femtoSMD, picoSMD, nanoSMD, microSMD and miniSMD series: standard industry practices. Please also avoid direct contact to the device.
- SMD series: rework should be confined to removal of the installed product and replacement with a fresh device.

Table S7 Tape and Reel Specifications for Surface-mount Devices (in Millimeters)

Description	femtoSMD	picoSMD	nanoSMD	microSMD	miniSMDC and decaSMDC050F/60	miniSMDE190	midSMD except decaSMDC050F/60	SMD	SMD2
	EIA 481-1	EIA 481-1	EIA 481-1	EIA 481-1	EIA 481-1	EIA 481-2	EIA 481-2	EIA 481-2	EIA 481-2
W	8.0 ± 0.30	8.0 ± 0.30	8.0 ± 0.30	8.0 ± 0.30	12.0 ± 0.30	24.0 ± 0.30	16.0 ± 0.30	16.0 ± 0.30	16.0 ± 0.30
P <sub>0</sub>	4.0 ± 0.10	4.0 ± 0.10	4.0 ± 0.10	4.0 ± 0.10	4.0 ± 0.10	4.0 ± 0.10	4.0 ± 0.10	4.0 ± 0.10	4.0 ± 0.10
P <sub>1</sub>	4.0 ± 0.10	4.0 ± 0.10	4.0 ± 0.10	4.0 ± 0.10	8.0 ± 0.10	8.0 ± 0.10	8.0 ± 0.10	8.0 ± 0.10	12.0 ± 0.10
P <sub>2</sub>	2.0 ± 0.05	2.0 ± 0.05	2.0 ± 0.05	2.0 ± 0.05	2.0 ± 0.05	2.0 ± 0.10	2.0 ± 0.10	2.0 ± 0.10	2.0 ± 0.10
A <sub>0</sub>	Table S8	Table S8	1.95 ± 0.10	2.9 ± 0.10	Table S8	5.70 ± 0.10	5.11 ± 0.15	5.6 ± 0.23	6.9 ± 0.23
B <sub>0</sub>	Table S8	Table S8	Table S8	3.50 ± 0.10	Table S8	11.90 ± 0.10	5.6 ± 0.23	8.1 ± 0.15	9.6 ± 0.15
B <sub>1</sub> max.	4.35	4.35	4.35	4.35	8.2	20.1	12.1	12.1	12.1
D <sub>0</sub>	1.55 ± .05	1.55 ± .05	1.55 ± .05	1.55 ± .05	1.5 + 0.10/-0.00	1.55 ± .05	1.5 + 0.10/-0.00	1.5 + 0.10/-0.00	1.5 + 0.10/-0.00
F	3.50 ± 0.05	3.50 ± 0.05	3.50 ± 0.05	3.50 ± 0.05	5.50 ± 0.05	11.50 ± 0.10	7.50 ± 0.10	7.50 ± 0.10	7.50 ± 0.10
E <sub>1</sub>	1.75 ± 0.10	1.75 ± 0.10	1.75 ± 0.10	1.75 ± 0.10	1.75 ± 0.10	1.75 ± 0.10	1.75 ± 0.10	1.75 ± 0.10	1.75 ± 0.10
E <sub>2</sub> min.	6.25	6.25	6.25	6.25	10.25	22.25	14.25	14.25	14.25
T max.	0.6	0.6	0.6	0.6	0.6	0.6	0.6	0.6	0.6
T <sub>1</sub> max.	0.1	0.1	0.1	0.1	0.1	0.1	0.1	0.1	0.1
K <sub>0</sub>	Table S8	Table S8	Table S8	Table S8	Table S8	0.95 ± 0.10	1.8 ± 0.15	3.2 ± 0.15	3.4 ± 0.15
Leader min.	390	390	390	390	390	400	400	400	400
Trailer min.	160	160	160	160	160	160	160	160	160

**Table S8 Tape and Reel Specifications for Surface-mount Devices (in Millimeters)**

	femtoSMDC005F femtoSMDC008F femtoSMDC010F femtoSMDC035F	femtoSMDC012F femtoSMDC016F femtoSMDC020F	picoSMDC012S picoSMDC020S picoSMDC035S	picoSMDC010S picoSMDC050S picoSMDC075S picoSMDC110S	All nanoSMDC series except nanoSMDC012F nanoSMDC016F nanoSMDC200F	nanoSMDC012F nanoSMDC016F nanoSMDC200F
A <sub>0</sub>	1.00 ± 0.1	1.00 ± 0.1	1.55 ± 0.1	1.60 ± 0.1	1.95 ± 0.1	1.95 ± 0.1
B <sub>0</sub>	1.85 ± 0.1	1.85 ± 0.1	2.50 ± 0.1	2.45 ± 0.1	3.50 +0.1/-0.08	3.5 ± 0.1
K <sub>0</sub>	0.90 ± 0.1	0.80 ± 0.1	0.86 ± 0.1	1.35 ± 0.1	0.89 ± 0.1	1.27 ± 0.1

	All microSMD series except microSMD200F	microSMD200F	miniSMDC014F~075F miniSMDC100F~110F/16 miniSMDC125F~150F/16 miniSMDC160F~260F	miniSMDC075F/24 miniSMDC110F/24 miniSMDC260F/12 miniSMDC260F/13.2 miniSMDC260F/16	miniSMDC150F/24	decaSMDC050F/60
A <sub>0</sub>	2.9 ± 0.1	2.9 ± 0.1	3.5 ± 0.1	3.7 ± 0.1	3.7 ± 0.1	5.0 ± 0.1
B <sub>0</sub>	3.5 ± 0.1	3.5 ± 0.1	4.95 ± 0.1	4.9 ± 0.1	4.9 ± 0.1	5.4 ± 0.1
K <sub>0</sub>	0.9 ± 0.1	1.27 ± 0.1	0.9 ± 0.1	1.4 ± 0.1	1.78 ± 0.1	1.7 ± 0.1

**Table S9 Reel Dimensions for Surface-mount Devices (in Millimeters)**

	femto/pico/nano/microSMD	miniSMDC	miniSMDE190	midSMD	SMD	SMD2
A max.	185	185	330	330	330	330
N min.	50	50	60	50	50	50
W <sub>1</sub>	8.4 + 1.5/-0.00	12.4 + 2.0/-0.00	24.4 + 2.0/-0.00	16.4 + 2.0/-0.00	16.4 + 2.0/-0.00	16.4 + 2.0/-0.00
W <sub>2</sub> max.	14.4	18.4	30.4	22.4	22.4	22.4

**Figure S15 EIA Referenced Taped Component Dimensions for Surface-mount Devices**

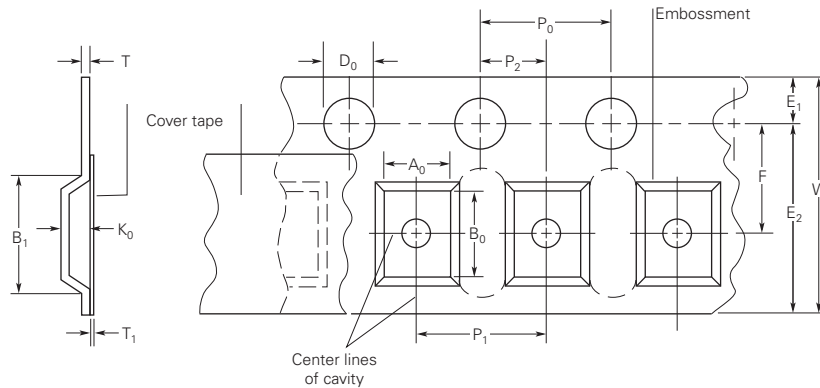
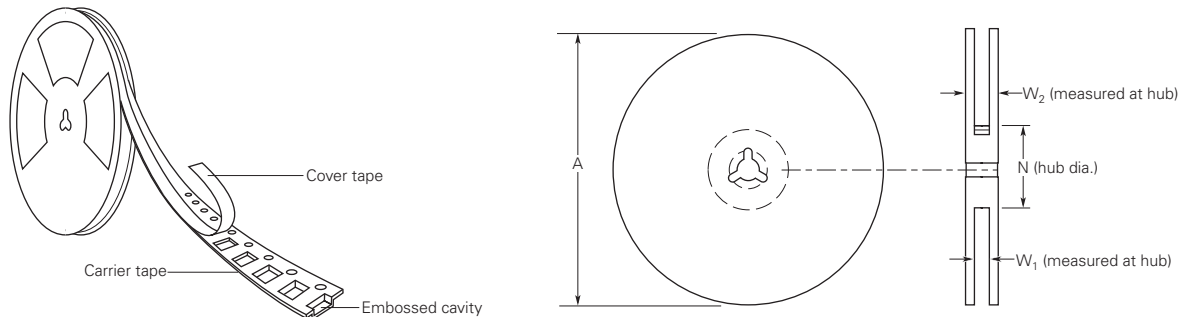
**Figure S16 EIA Referenced Reel Dimensions for Surface-mount Devices**

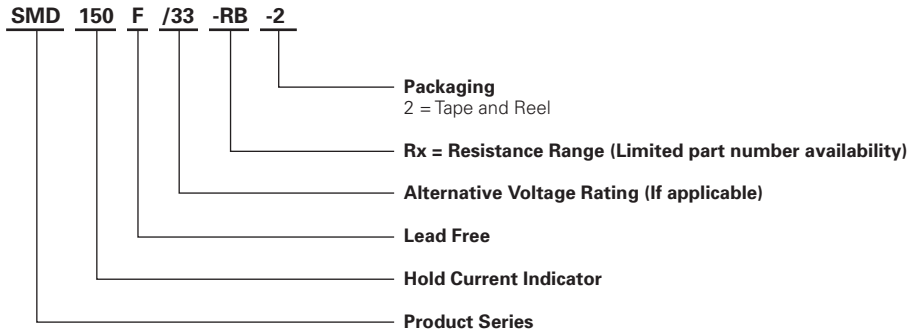
## Part Numbering System for Surface-mount Devices



### Warning :

- Users should independently evaluate the suitability of and test each product selected for their own application.
- Operation beyond the maximum ratings or improper use may result in device damage and possible electrical arcing and flame.
- These devices are intended for protection against damage caused by occasional overcurrent or overtemperature fault conditions and should not be used when repeated fault conditions or prolonged trip events are anticipated.
- Contamination of the PPTC material with certain silicone-based oils or some aggressive solvents can adversely impact the performance of the devices.
- Device performance can be impacted negatively if devices are handled in a manner inconsistent with recommended electronic, thermal, and mechanical procedures for electronic components.
- PPTC devices are not recommended for installation in applications where the device is constrained such that its PTC properties are inhibited, for example in rigid potting materials or in rigid housings, which lack adequate clearance to accommodate device expansion.
- Operation in circuits with a large inductance can generate a circuit voltage ( $Ldi/dt$ ) above the rated voltage of the device.