

### CN074 Series AdvancedMC Connector for AdvancedTCA

- Support 12.5Gbps transmission for telecom applications  
CN074 supports data transfer between AdvancedMC and AdvancedTCA Carrier Board (blade) at 12.5Gbps and beyond, optimizing the performance of the AdvancedTCA system.  
CN074 is PICMG AMC.0 compliant.
- Behind the high-speed connectivity: „CMT“ and „YFLEX“  
The unprecedented high-speed connectivity is achieved by combining our unique connector-mounting technology, CMT and our patented flexible circuit board, YFLEX. The combination of CMT and YFLEX ideally reduces insertion loss and cross talk to the absolute minimum, ensuring data transfer rates of 12.5Gbps and beyond without signal loss.
- Covers full range of AdvancedMCs but also allows customization  
CN074 not only covers the full range of standard AdvancedMCs but also allows for design modifications e.g. special pin configuration to meet your specific needs.

AdvancedMC Connectors for AdvancedTCA

CN074-085-0003 (Type B)

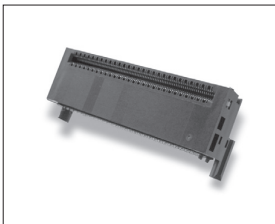

CN074-170-0005 (Type B+)

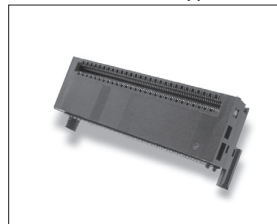

CN074-170-0006 (Type AB)

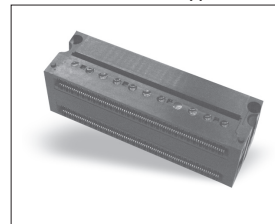

CN074-340-0001 (Type A+B+)

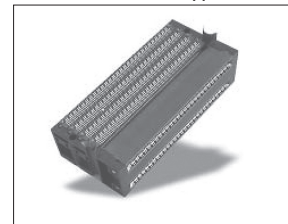

CN074-340-0003 (Type A+B+ mid size)

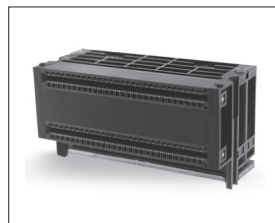

### YFLEX

YFLEX is Yamaichi Electronics LCP-based flexible circuit board. In the Connectors, YFLEX is used as a cable that ensures high-speed data transmission with minimal signal loss. For more information about “YFLEX”

YFLEX  
LCP-based flexible circuit board



# Series CN074 AdvancedMC™ Connector for ATCA (Type A+B+)

AdvancedMC  
Connectors

## Specifications

Insulation Resistance:	100MΩ min. at 80V DC
Withstanding Voltage:	80Vrms
Differential Impedance:	100Ω ±10Ω
Line Resistance:	Differential pair conductors = 375mΩ
	General purpose conductors = 90mΩ
	Power conductors = 90mΩ
	Ground conductors = 60mΩ
Attenuation:	<1dB at 8GHz and <2dB at 12GHz
Return Loss:	<20dB at 5GHz and <13dB at 8GHz
Cross Talk Ratio:	NE and FE <2%
Operating Temp. Range:	-55°C to +105°C
Mating Cycles:	200 times

## Materials

Case:	PA9T (UL94V-0), black
Housing:	LCP (UL94V-0), black
Contact:	Copper Alloy, Gold plating over Nickel
YFLEX:	LCP/Copper, Gold plating over Nickel
Screw:	Stainless
Stiffener:	Stainless, PA9T (UL94V-0), black

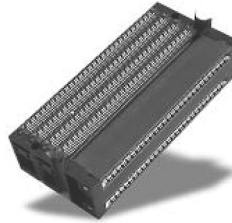

## Part Number (Details)

CN074 - 340 - 0001

\*Series

No. of Contacts

Design Number

\*INFO: including screws and stiffener

## Features

Connector Type:	Extended
Carrier Board:	Cutaway
Contacts:	340
Module Slots:	2

AdvancedMC Connectors for AdvancedTCA

## Outline Connector Dimensions CN074-340-0001 (Type A+B+)

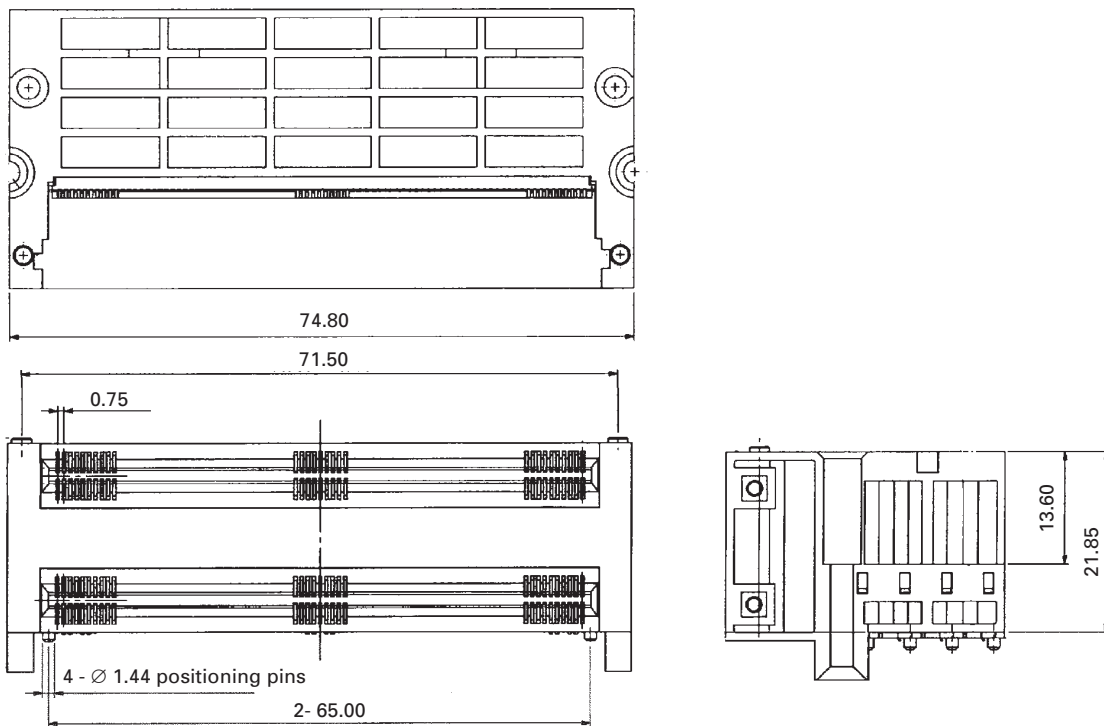

## PCB Layout CN074-340-0001 (Type A+B+)

Top View from Connector

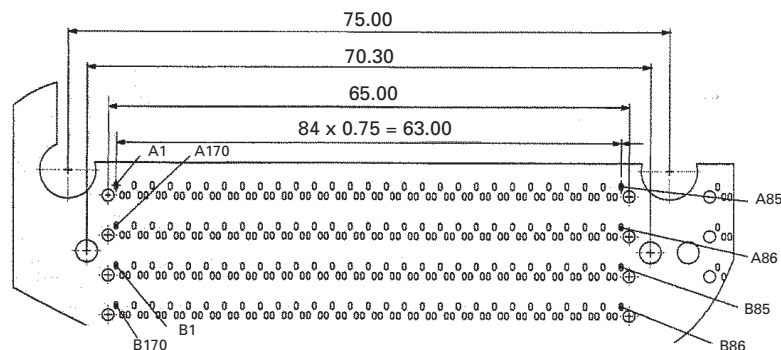

### Specifications

Insulation Resistance:	100MΩ min. at 80V DC
Withstanding Voltage:	80Vrms
Differential Impedance:	100Ω ±10Ω
Line Resistance:	Differential pair conductors = 375mΩ
	General purpose conductors = 90mΩ
	Power conductors = 90mΩ
	Ground conductors = 60mΩ
Attenuation:	<1dB at 8GHz and <2dB at 12GHz
Return Loss:	<20dB at 5GHz and <13dB at 8GHz
Cross Talk Ratio:	NE and FE <2%
Operating Temp. Range:	-55°C to +105°C
Mating Cycles:	200 times

### Part Number (Details)

**CN074 - 170 - 0006**

*Series	
No. of Contacts	
Design Number	

\*INFO: including screws and stiffener

### Materials

Case:	PA9T (UL94V-0), black
Housing:	LCP (UL94V-0), black
Contact:	Copper Alloy, Gold plating over Nickel
YFLEX:	LCP/Copper, Gold plating over Nickel
Screw:	Stainless
Stiffener:	Stainless, PA9T (UL94V-0), black

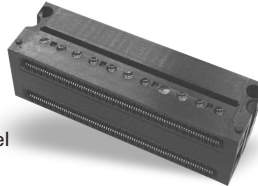

### Features

Connector Type:	Basic
Carrier Board:	Cutaway
Contacts:	170
Module Slots:	2

### Outline Connector Dimensions CN074-170-0006 (Type AB)

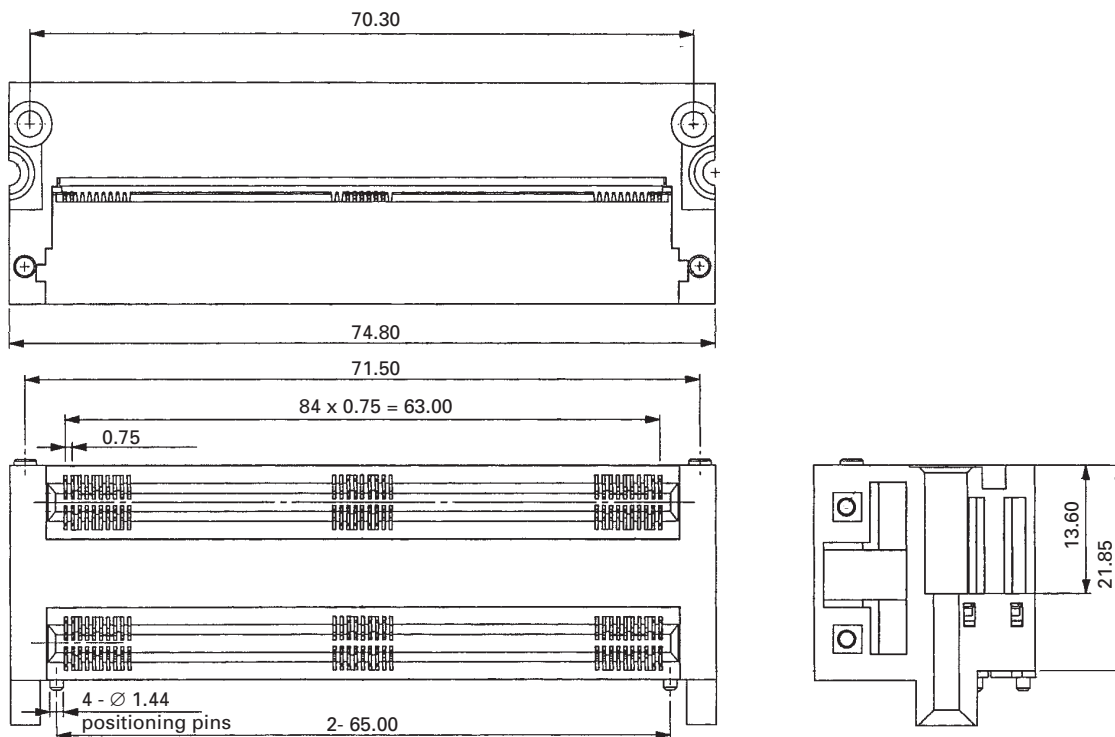

### PCB Layout CN074-170-0006 (Type AB)

Top View from Connector

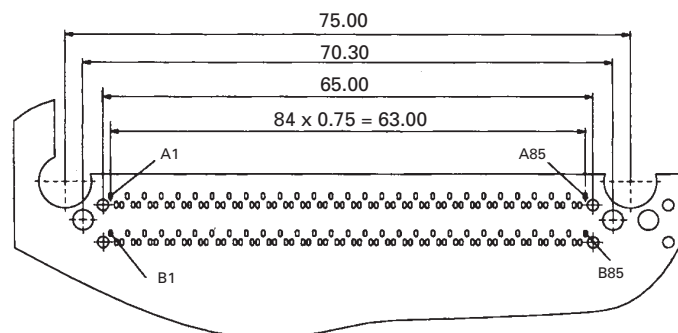

#### Specifications

Insulation Resistance:	100MΩ min. at 80V DC
Withstanding Voltage:	80Vrms
Differential Impedance:	100Ω ±10Ω
Line Resistance:	Differential pair conductors = 375mΩ
	General purpose conductors = 90mΩ
	Power conductors = 90mΩ
	Ground conductors = 60mΩ
Attenuation:	<1dB at 8GHz and <2dB at 12GHz
Return Loss:	<20dB at 5GHz and <13dB at 8GHz
Cross Talk Ratio:	NE and FE <2%
Operating Temp. Range:	-55°C to +105°C
Mating Cycles:	200 times

#### Materials

Case:	PA9T (UL94V-0), black
Housing:	LCP (UL94V-0), black
Contact:	Copper Alloy, Gold plating over Nickel
YFLEX:	LCP/Copper, Gold plating over Nickel
Screw:	Stainless
Stiffener:	Stainless, PA9T (UL94V-0), black

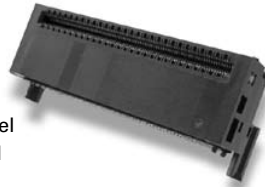

#### Part Number (Details)

**CN074 - 085 - 0003**

\*Series

No. of Contacts

Design Number

**\*INFO:** including screws and stiffener

#### Features

Connector Type:	Basic
Carrier Board:	Conventional
Contacts:	85
Module Slots:	1

#### Outline Connector Dimensions CN074-085-0003 (Type B)

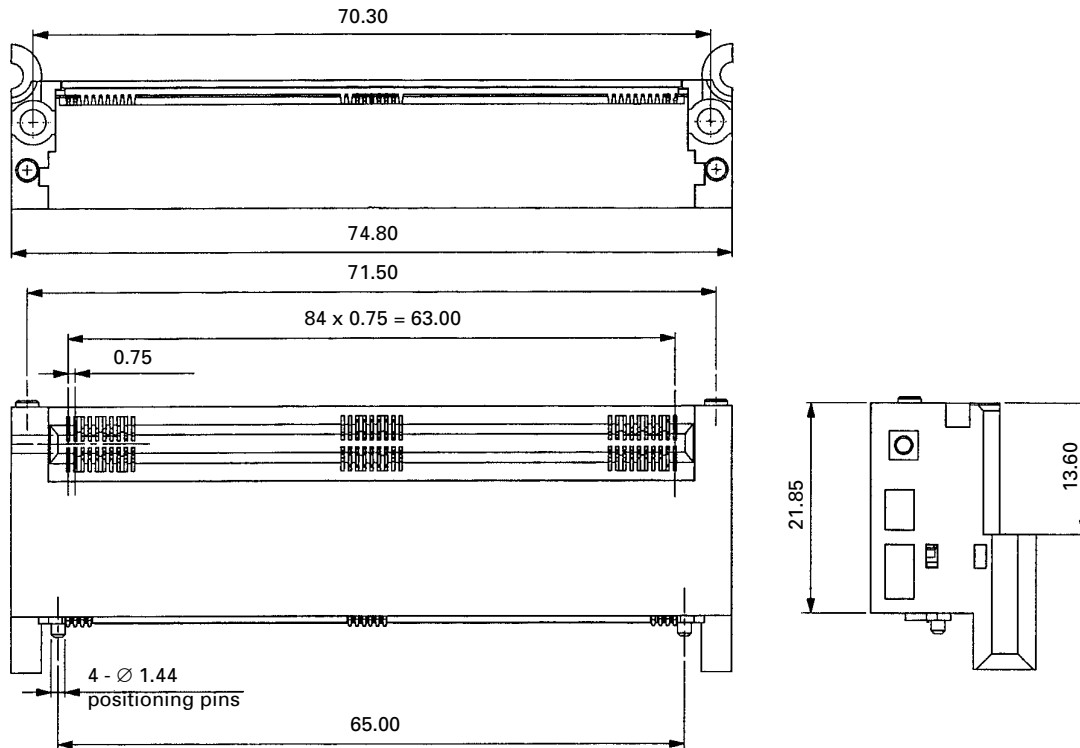

#### PCB Layout CN074-085-0003 (Type B)

Top View from Connector

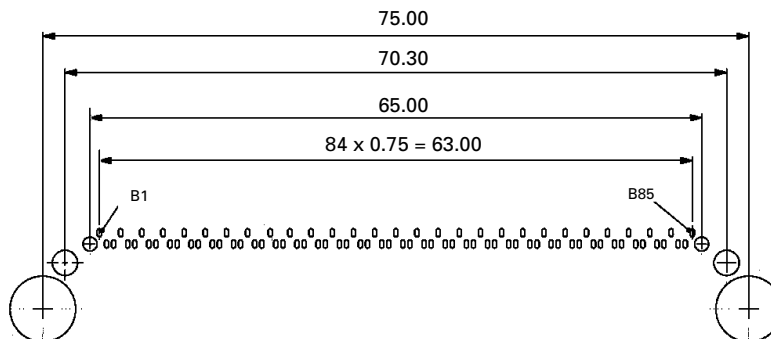

# Series CN074 AdvancedMC™ Connector for ATCA (Type B+)

### Specifications

Insulation Resistance:	100MΩ min. at 80V DC
Withstanding Voltage:	80Vrms
Differential Impedance:	100Ω ±10Ω
Line Resistance:	Differential pair conductors = 375mΩ
	General purpose conductors = 90mΩ
	Power conductors = 90mΩ
	Ground conductors = 60mΩ
Attenuation:	<1dB at 8GHz and <2dB at 12GHz
Return Loss:	<20dB at 5GHz and <13dB at 8GHz
Cross Talk Ratio:	NE and FE <2%
Operating Temp. Range:	-55°C to +105°C
Mating Cycles:	200 times

### Part Number (Details)

**CN074 - 170 - 0005**

*Series	
No. of Contacts	
Design Number	

\*INFO: including screws and stiffener

### Materials

Case:	PA9T (UL94V-0), black
Housing:	LCP (UL94V-0), black
Contact:	Copper Alloy, Gold plating over Nickel
YFLEX:	LCP/Copper, Gold plating over Nickel
Screw:	Stainless
Stiffener:	Stainless, PA9T (UL94V-0), black

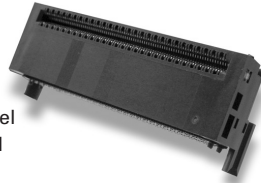

### Features

Connector Type:	Extended
Carrier Board:	Conventional
Contacts:	170
Module Slots:	1

AdvancedMC Connectors for AdvancedTCA

### Outline Connector Dimensions CN074-170-0005 (Type B+)

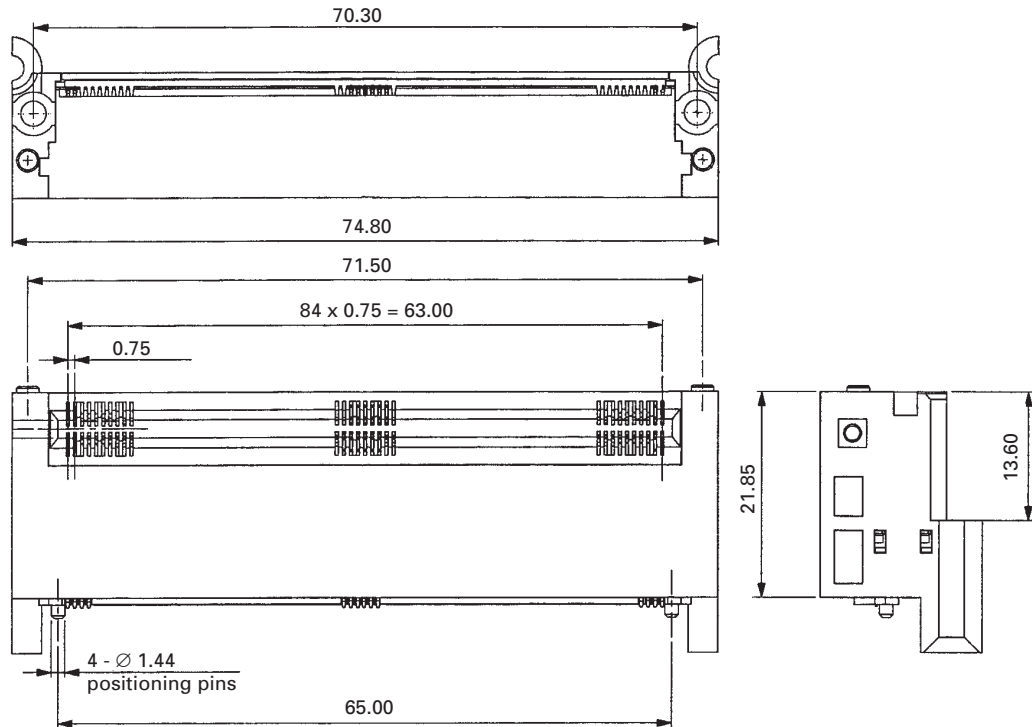

### PCB Layout CN074-170-0005 (Type B+)

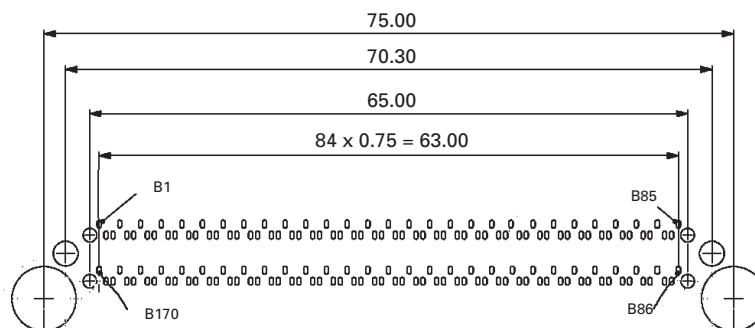

Top View from Connector

# advanced<sup>®</sup> CMT

no compromise!

✓  
**CMT** Speed

✓  
**CMT** Flexibility

✓  
**CMT** Reliability

## CMT = Compression Mount Technology

AdvancedCMT is the quality trademark of Yamaichi Electronics for connectors used in Advanced TCA<sup>®</sup> and MicroTCA<sup>®</sup>

CMT is a contact technology between an electro-mechanical component (e.g. connector or test adapter for semi-conductors) and a printed circuit board.

The electrical contact is established through the compression of the two contact faces by screwing the component to the PCB.

A stiffener is screwed from the backside to avoid stress on the PCB.

Easy field repair and component replacement is possible.

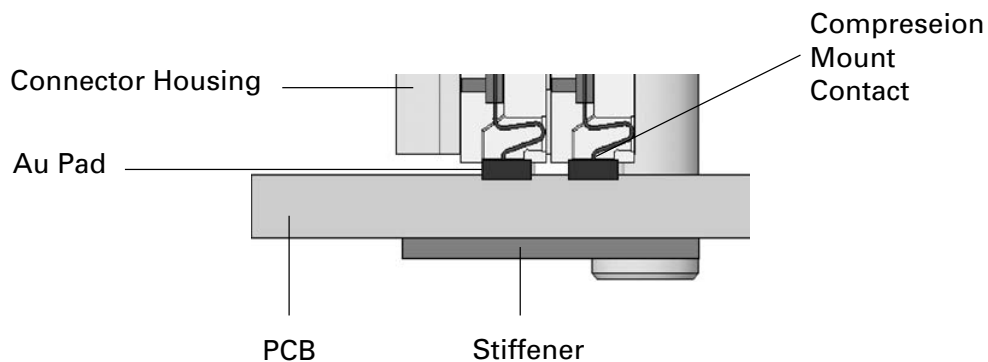

## CMT Speed

CMT allows the usage of blind via's, micro via's or drillings with a very small diameter thus

- reducing stub-effects and reflexion
- reducing cross-talk and insertion loss
- providing characteristic impedance matching
- enabling transmission waveform @12.5 Gbps (see diagram below)

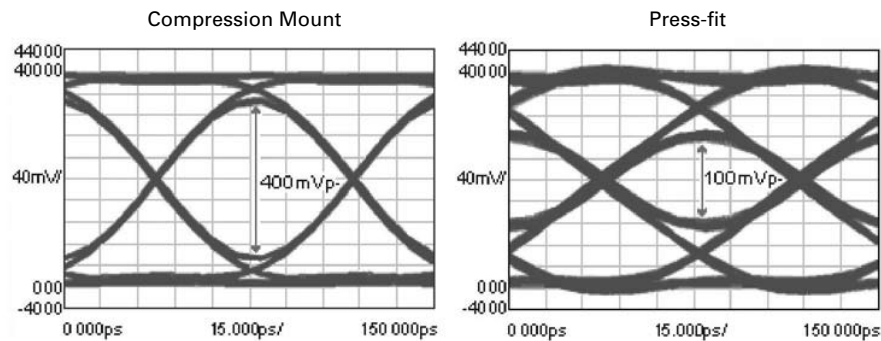
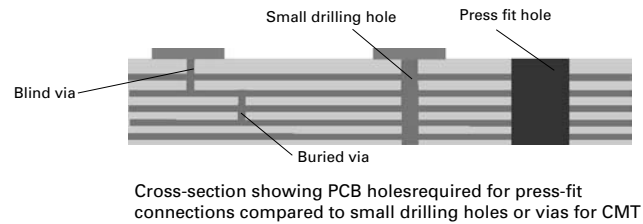

## CMT Flexibility

The usage of blind via's, micro via's or drillings with very small diameter also provides

- more space for signal routing on the backplane
- possibilities to reduce the number of backplane layers up to 30%
- cost saving due to less backplane layers

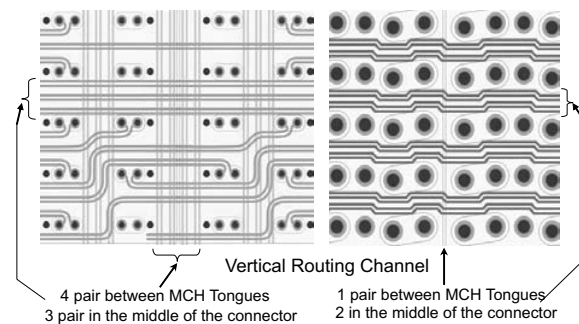

## CMT Reliability

AdvancedCMT connectors from Yamaichi have proven their reliability under vibration, temperature etc. according to all relevant specifications for both the CMT and the card edge connection area

Yamaichi is using wider contacts to compensate manufacturing tolerances of the PCB

- No additional "guiding" needed -

Yamaichi contact shape has the contact point at the bending area (not at the stamping / cutting area)

- No damage of the contact surface while mating -
- Stable contact resistance during the lifetime -
- Precisely defined contact force -

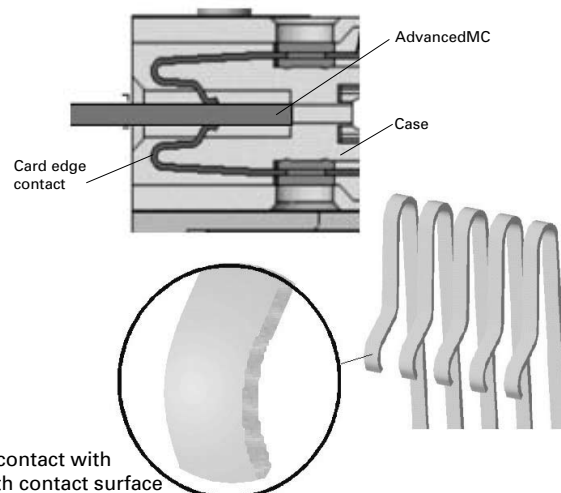

Yamaichi Electronics high-speed & high-frequency technology makes the CN Series by far the best choice for next-generation network equipment.

- **AdvancedTCA and MicroTCA**  
Are open architectures standardized by more than 100 members of PICMG for next-generation telecommunications. Yamaichi Electronics supports the industry's latest standards with its CN074, CN080 and CN084 Series.
- **PICMG** (PCI Industrial Computers Manufacturers Group)  
PICMG is a U.S.-based consortium where more than 600 computer, telecommunications and related manufacturers participate to develop open architectures including AdvancedTCA and MicroTCA.
- **AdvancedMC** (Advanced Mezzanine Card)  
AdvancedMC are the primary component of AdvancedTCA and MicroTCA that provides these systems with functional elements such as telecom connectivity, processors and mass-storage. The Hot-Swappable feature allows you to install or uninstall the cards directly from the front of AdvancedTCA and MicroTCA shelf without turning off power.
- **AdvancedTCA** (Advanced Telecom Computing Architecture)  
AdvancedTCA is a series of specifications developed by PICMG for carrier-grade telecom applications. With cutting-edge high-speed interconnect technology and processors introduced, the AdvancedTCA system provides core applications with high reliability, availability and serviceability. An AdvancedTCA shelf accepts 14 AdvancedTCA Carrier Boards (blades) and each board accepts up to eight AdvancedMC's. By merely installing or uninstalling AdvancedMCs on/from the boards, you can easily manage the configuration of your AdvancedTCA system.
- **MicroTCA** (Micro Telecom Computing Architecture)  
MicroTCA is a series of specifications developed by PICMG to incorporate the key elements of AdvancedTCA for physically smaller edge applications that AdvancedTCA may not apply.
- **MCH** (MicroTCA Carrier Hub)  
Is the MicroTCA Carrier Hub for management of the MicroTCA system

