

SKD 82



SEMIPONT® 3

Power Bridge Rectifiers

SKD 82

Features

- Robust plastic case with screw terminals
- Large, isolated base plate
- Blocking voltage up to 1800 V
- High surge current
- Three phase bridge rectifier
- Easy chassis mounting
- UL recognized, file no. E 63 532

Typical Applications

- Three phase rectifiers for power supplies
- Input rectifiers for variable frequency drives
- Rectifiers for DC motor field supplies
- Battery charger rectifiers

- 1) Freely suspended or mounted on an isolator
- 2) Mounted on a painted metal sheet of min. 250 x 250 x 1 mm;
 $R_{th(s-a)} = 1,8 \text{ K/W}$
- 3) Available in limited quantities

| V_{RSM} V | V_{RRM}, V_{DRM} V | $I_D = 80 \text{ A}$ (full conduction) ($T_c = 110 \text{ °C}$) |
|----------------|-------------------------|--|
| 400 | 400 | SKD 82/04 |
| 800 | 800 | SKD 82/08 |
| 1200 | 1200 | SKD 82/12 |
| 1400 | 1400 | SKD 82/14 |
| 1600 | 1600 | SKD 82/16 |
| 1800 | 1800 | SKD 82/18 ³⁾ |

| Symbol | Conditions | Values | Units |
|---------------|--|---------------|------------------|
| I_D | $T_c = 110 \text{ °C}$ resistive / inductive load | 80 | A |
| | $T_a = 45 \text{ °C}$; isolated ¹⁾ | 12 | A |
| | $T_a = 45 \text{ °C}$; chassis ²⁾ | 26 | A |
| | $T_a = 45 \text{ °C}$; P1A/120 (P1A/200) | 54 (63) | A |
| I_{FSM} | $T_{vj} = 25 \text{ °C}$; 10 ms | 750 | A |
| | $T_{vj} = 150 \text{ °C}$; 10 ms | 640 | A |
| i^2t | $T_{vj} = 25 \text{ °C}$; 8,3 ... 10 ms | 2800 | A ² s |
| | $T_{vj} = 150 \text{ °C}$; 8,3 ... 10 ms | 2000 | A ² s |
| V_F | $T_{vj} = 25 \text{ °C}$; $I_F = 150 \text{ A}$ | max. 1,6 | V |
| $V_{(TO)}$ | $T_{vj} = 150 \text{ °C}$ | max. 0,85 | V |
| r_T | $T_{vj} = 150 \text{ °C}$ | max. 5 | mΩ |
| I_{RD} | $T_{vj} = 25 \text{ °C}$; $V_{DD} = V_{DRM}$; $V_{RD} = V_{RRM}$ | max. 0,5 | mA |
| | $T_{vj} = 150 \text{ °C}$; $V_{RD} = V_{RRM}$ | 6 | mA |
| $R_{th(j-c)}$ | per diode | 1,1 | K/W |
| | total | 0,183 | K/W |
| $R_{th(c-s)}$ | | 0,07 | K/W |
| | T_{vj} | -40 ... + 150 | °C |
| T_{stg} | | -40 ... + 125 | °C |
| V_{isol} | a. c. 50 Hz; r.m.s.; 1 s / 1 min. | 3600 (3000) | V |
| M_s | to heatsink | $5 \pm 15\%$ | Nm |
| M_t | to terminals | $5 \pm 15\%$ | Nm |
| m | | 165 | g |
| Case | | G 36 | |

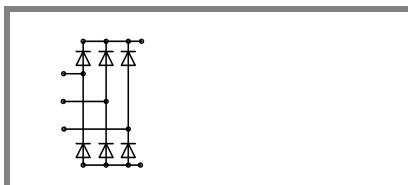

SKD

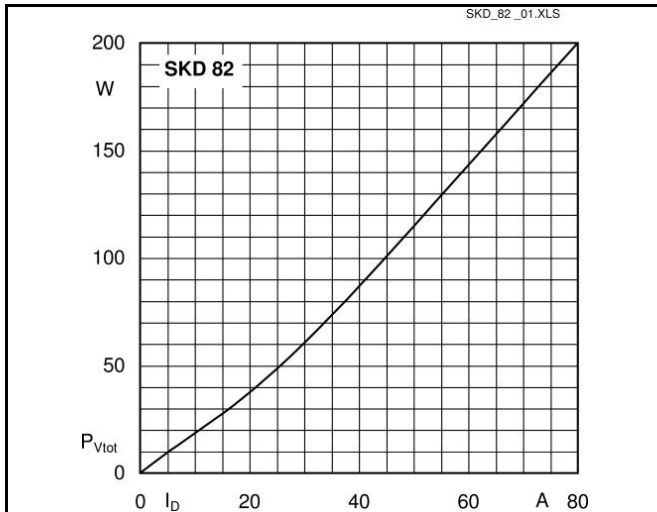

Fig. 3L Power dissipation vs. output current

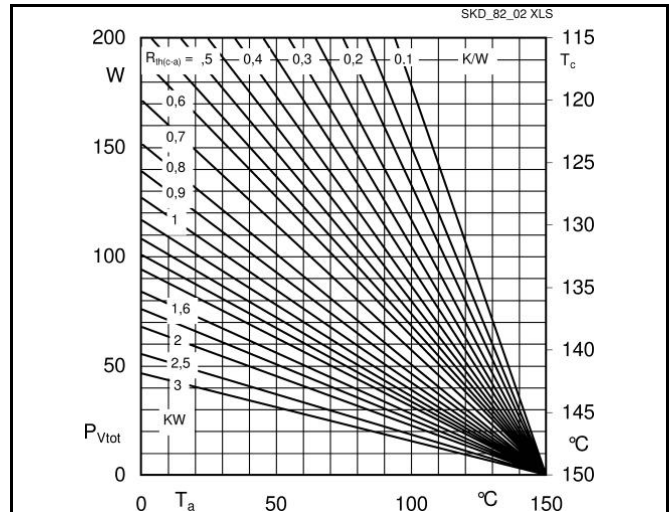

Fig. 3R power dissipation vs. case temperature

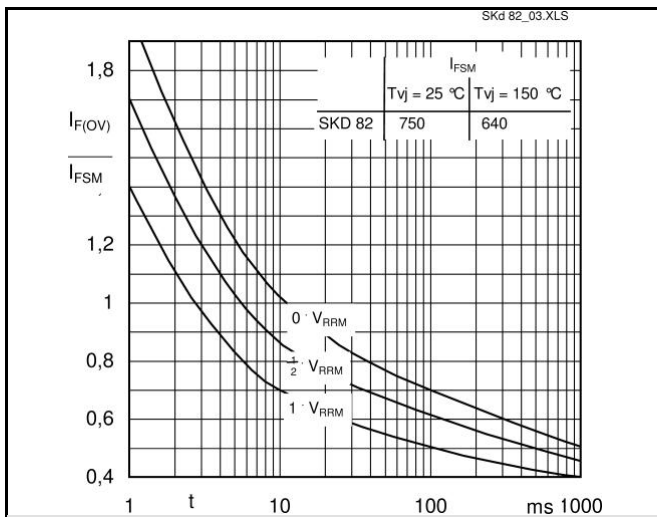

Fig. 6 Surge overload characteristics vs. time

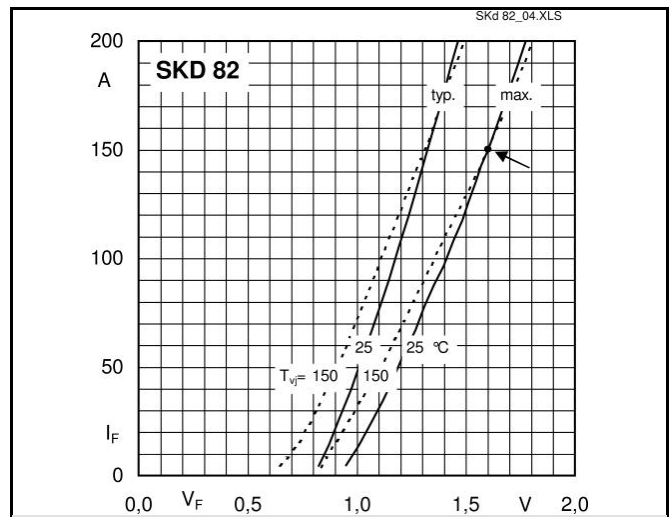

Fig. 9 Forward characteristics of a diode arm

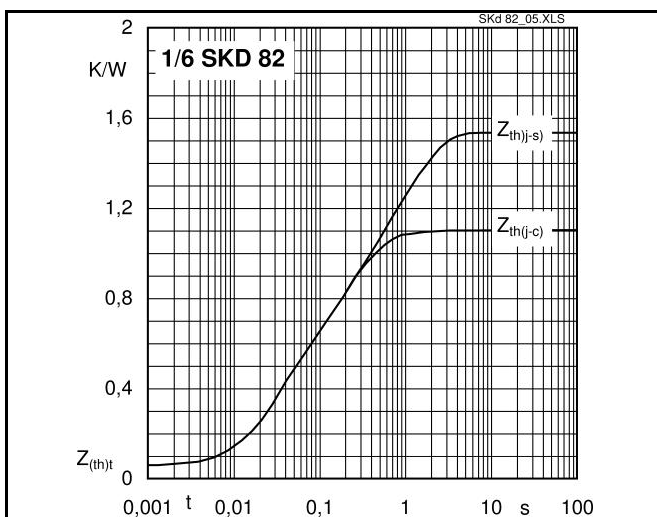
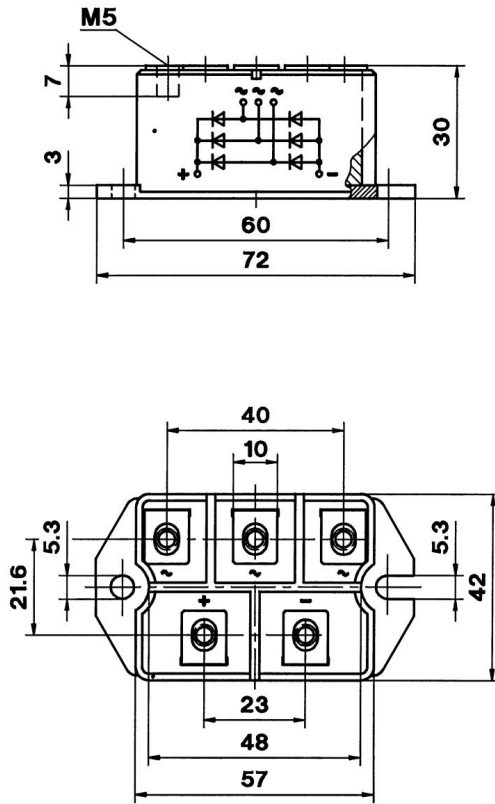

Fig. 12 Transient thermal impedance vs. time

Dimensions in mm



Case G 36

This technical information specifies semiconductor devices but promises no characteristics. No warranty or guarantee expressed or implied is made regarding delivery, performance or suitability.