

# PolySwitch Telecommunications and Networking

## Resettable Devices

PolySwitch devices for telecommunication and networking applications were initially designed over ten years ago to meet the growing demand for resettable overcurrent protection. These product families help provide protection against power cross and power induction surge as defined in ITU, Telcordia, and UL. Available in chip, surface-mount, and radial-leaded configurations, PolySwitch devices help improve the reliability of customer premise and network equipment world wide.

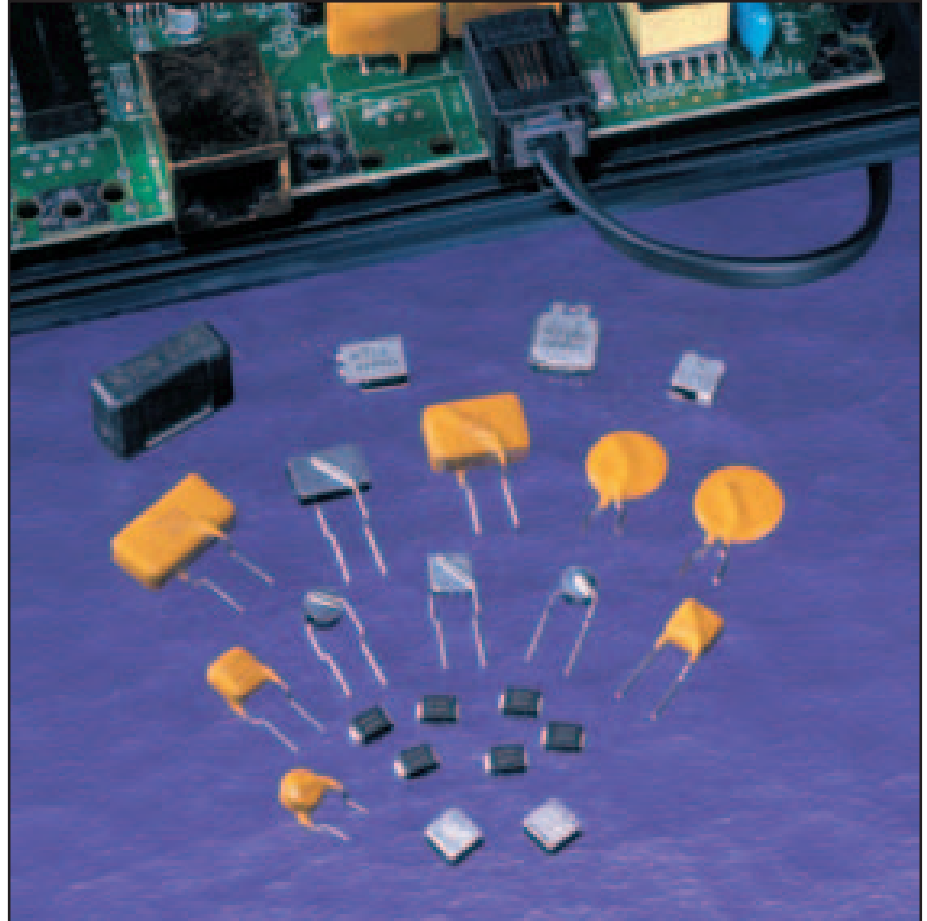

4

### Benefits:

- Many product choices give engineers more design flexibility
- Compatible with high volume electronics assembly
- Assist in meeting regulatory requirements
- Improved line balance
- Applicable for legacy POTS and modern digital communications equipment.

### Features:

- Resettable overcurrent protection
- Surface-mount, radial-leaded, and chip form factors
- Fast time-to-trip
- Agency recognition: UL, CSA, TÜV
- Resistance sorted and matched devices available
- Low parasitic capacitance/flat impedance with frequency

### Target Applications:

- Modems
- Phone sets
- Fax machines
- Phone wall outlets
- Alarm systems
- PBX systems
- MDF modules
- Analog and digital line cards
- T1/E1 equipment
- xDSL modems and splitters
- Powered ethernet systems
- VoIP (Voice over IP equipment)
- LAN, WAN equipment
- Customer premise equipment
- Access network hardware

Products in this section are grouped by:

**Application/Specification, Product Series, Hold Current**

**Step 1. Review the Protection Application Guide on page 303 which is based on the agency specification required to qualify the final equipment.**

Use the selection guide to narrow your product selection based on key device characteristics.

**Step 2. Verify that the PolySwitch device hold current will accommodate the telecommunications circuit's maximum ambient temperature and normal operating current.**

Look across the top of the thermal derating table T2 on page 306 to find the temperature that most closely matches the circuit's maximum operating temperature. Look down that column to find the value equal to or greater than the circuit's normal operating current. Now look to the far left of that row to find the part number for the PolySwitch telecommunications device that will best accommodate the circuit.

Note: The thermal derating curves in Figure T1 on page 307 are the normalized representations of the data in the thermal derating table.

**Step 3. Verify that the time-to-trip characteristic of the chosen device meets the protection requirements of the telecommunications equipment circuit.**

Time-to-trip is the amount of time it takes for a device to switch to a high resistance state once a fault current has been applied across the device. Identifying the PolySwitch device's time-to-trip is important in order to provide the desired protection capabilities. If the device you choose trips too fast, undesired or nuisance tripping will occur. If the device trips too slowly, the components being protected may be damaged before the device switches to a high resistance state.

Refer to typical time-to-trip curves (Figures T12-17) on pages 313-315 for each of the PolySwitch devices. If the PolySwitch device's time-to-trip is too fast or too slow for the circuit, go back to Step 2 and choose an alternate device.

**Step 4. Verify ambient operating condition.**

Ensure that your application's minimum and maximum ambient temperatures are within the operating temperature range of -40°C to 85°C.

**Step 5. Independently evaluate and test the device.**

PolySwitch devices assist your telecommunications equipment in meeting agency requirements. To confirm your selection, independently evaluate and test the device to the application requirements.

Protection Application Guide for Telecommunications and Networking Devices

To use this guide, follow the steps below:

1. Select your equipment type from the guide below.
2. Select the type of protection depending on the agency and regional specifications in the second column.
3. Use the Key Device Selection Criteria (size, resistance, time-to-trip) to determine best suitability for your application.
4. Use the Agency Specification/ PolySwitch Device Selection Guide on the next page to select a specific part number for each application based on the agency requirements.

Application	Region/ Specification	PolySwitch Resettable Devices			SiBar Thyristor Surge Protectors <sup>1</sup>
		Key Device Selection Criteria Small Footprint	Low Resistance	Fast Time-to-Trip	
<b>Customer premises equipment, IT equipment</b> Analog modems, V.90 modems, ISDN modems, xDSL modems, ADSL splitters, phone sets, fax machines, answering machines, caller ID, internet appliances, PBX systems, POS terminals, wall plugs	<b>North America</b> TIA-968-A (formerly FCC Part 68), UL 60950	TSM600-250 TRF600-150 TS600-170 FT600-1250†	TSM600-250-RA TRF600-150 TS600-200-RA FT600-1250	TSM600-250 TRF600-150 TS600-170	TVBxxxSA or TVAxxxSA with TR/TS; TVBxxxSC with TR/TS or fuse
	<b>Europe/Asia/South America</b> ITU K.21	TRF250-180 TR250-120 TR250-145 TS250-130 TSV250-130	TRF250-180 TS250-130-RA TSV250-130	TR250-120T-R2 TS250-130-RB	TVBxxxSA TVAxxxSA
<b>Access network equipment (*)</b> Remote terminals, line repeaters, multiplexers, cross-connects, WAN equipment	<b>North America</b> Telcordia GR-1089	TSM600-250 TR600-160 TS600-200-RA FT600-1250	TSM600-250-RA TR600-160-RA TS600-200-RA FT600-1250	TSM600-250 TR600-160 TS600-170	TVBxxxSC
	<b>Europe/Asia/South America</b> ITU K.45	TRF250-180 TR250-120 TR250-145 TS250-130 TSV250-130	TRF250-180 TS250-130-RA TSV250-130	TR250-120T-R2 TS250-130-RB	TVBxxxSA TVAxxxSA
<b>Central office switching equipment (*)</b> Analog/POTS linecards, ISDN linecards, xDSL modems, ADSL/VDSL splitters, T1/E1 linecards, multiplexers, CSU/DSU, servers	<b>North America</b> Telcordia GR-1089	TSM600-250 TR600-160 TS600-200-RA FT600-1250	TSM600-250-RA TR600-160-RA TS600-200-RA FT600-1250	TSM600-250 TR600-160 TS600-170	TVBxxxSC
	<b>Europe/Asia/South America</b> ITU K.20	TRF250-180 TR250-120 TR250-145 TS250-130 TSV250-130	TRF250-180 TS250-130-RA TSV250-130	TR250-120T-R2 TS250-130-RB	TVBxxxSA TVAxxxSA
<b>Primary protection modules (*)</b> MDF modules, Network Interface Devices (NID)	<b>North America</b> Telcordia GR-974	TRF250-180 TCF250-180	TRF250-180 TCF250-180	TRF250-180 TCF250-180	N/A
	<b>Europe/Asia/South America</b> ITU K.20	TCF250-120T TR240-120T TR250-120T TS250-130 TSV250-130	TC250-145T TGC250-145T TR250-145-RA TS250-130-RA TSV250-130	TCF250-120T TGC250-120T TR250-120T-R2 TS250-130-RB	N/A
<b>Short-haul/intrabuilding communications equipment (*)</b> LAN equipment, VoIP cards, cable telephony NIUs, wireless local loop handsets	<b>North America</b> Telcordia GR-1089 intrabuilding	TSL250-080 TR250-120 TS250-130	TR250-145 TR250-180 TS250-130-RA TSV250-130	TR250-120T-R2 TSL250-080	TVBxxxSA TVAxxxSA
	<b>Europe/Asia/South America</b> ITU K.21	TRF250-180 TR250-120 TR250-145 TS250-130 TSV250-130	TRF250-180 TS250-130-RA TSV250-130	TR250-120T-R2 TS250-130-RB	TVBxxxSA TVAxxxSA
<b>LAN intrabuilding power cross protection</b> LAN equipment, VoIP cards, IP phones		TSL250-080	TSL250-080	TSL250-080	TVBxxxSA TVAxxxSA
<b>IEEE 802.3 Power over LAN protection</b> Powered ethernet switches and terminals, IP phones, wireless LAN base stations, microcellular base stations, VoIP cards		SMD050-2018	SMD050-2018	SMD050-2018	N/A
<b>Cable telephony powering systems</b> Power passing taps		BBR550	BBR750	BBR550	N/A

**Notes:** This list is not exhaustive. Raychem Circuit Protection welcomes our customers' input for additional application ideas for PolySwitch resettable devices.

\*For improved line balance in these applications, resistance-matched parts are recommended.

<sup>1</sup>For more information on Raychem Circuit Protection SiBar thyristor surge protectors, refer to the SiBar product section on page 339.

†FT600-1250 are surface mount Telecom fuse devices. FT600-0500 and FT600-2000 reference also available. See FT600 section.



## Agency Specification/PolySwitch Selection Guide for Telecommunications and Networking Devices

Use the guide below to select the PolySwitch devices which are typically used in your application. The following pages contain the specifications for the part numbers recommended below.

PolySwitch devices assist telecommunication equipment in meeting the applicable protection requirements of these industry specifications. Refer to individual agency specifications for test

procedures and circuit schematics. Users should independently evaluate the suitability of, and test each product for their application.

Family	Product *	Lightning	Power Cross
TGC250 TC250 TCF	TGC/TC250-145T TC250-180 TCF250-120T	ITU K.20/21/45 – 1.5kV 10/700µs ITU K.20/21/45 – 4.0kV 10/700µs **	ITU K.20/21/45 – 230V <sub>AC</sub> 10Ω ITU K.20/21/45 – 600V <sub>AC</sub> 600Ω
TR250 TRF250	TR250-080U  TR250-110U TR250-120 TR250-120T TR250-120U TR250-120UT TR250-145 TR250-145U TRF250-180	ITU K.20 – 1.0kV 10/700µs  ITU K.20/21/45 – 1.5kV 10/700µs ITU K.20/21/45 – 4.0kV 10/700µs **	ITU K.20 – 230V <sub>AC</sub> 10Ω ITU K.20 – 600V <sub>AC</sub> 600Ω  ITU K.20/21/45 – 230V <sub>AC</sub> 10Ω ITU K.20/21/45 – 600V <sub>AC</sub> 600Ω
TSV250 TS250	TSV250-130 TS250-130	ITU K.20/21/45 – 1.5kV 10/700µs ITU K.20/21/45 – 4.0kV 10/700µs **	ITU K.20/21/45 – 230V <sub>AC</sub> 10Ω ITU K.20/21/45 – 600V <sub>AC</sub> 600Ω
TSL250	TSL250-080	Telcordia GR-1089 Intrabuilding – Surge 1 & 2	Telcordia GR-1089 Intrabuilding – 120V <sub>AC</sub> 25A ITU K.20/21/45 – 230V <sub>AC</sub> 10Ω
TR600	TRF600-150 TR600-160	TIA-968-A (formerly FCC Part 68) Telcordia GR-1089 – Level 1 and 2 ***	UL60950, 3rd Ed. – 600V <sub>AC</sub> 40A Telcordia GR-1089 – 600V <sub>AC</sub> 60A
TS600	TS600-170 TS600-200-RA	TIA-968-A (formerly FCC Part 68) Telcordia GR-1089 – Level 1 and 2 ***	UL60950, 3rd Ed. – 600V <sub>AC</sub> 40A Telcordia GR-1089 – 600V <sub>AC</sub> 60A
TSM600	TSM600-250 TSM600-250-RA	TIA-968-A (formerly FCC Part 68) Telcordia GR-1089 – Level 1 and 2	UL60950, 3rd Ed. – 600V <sub>AC</sub> 40A Telcordia GR-1089 – 600V <sub>AC</sub> 60A
FT600†	FT600-0500  FT600-1250 FT600-2000	TIA-968-A - Type A & B  TIA-968-A - Type A & B	UL60950, 600V <sub>AC</sub> 40A  UL60950, 3rd Ed. – 600V <sub>AC</sub> 40A Telcordia GR-1089 – 600V <sub>AC</sub> 60A

### Notes:

\*Applies to all products which share the same prefix.

\*\*Tested with 230V gas discharge tube primary protector.

\*\*\*May require 10 Ω series resistor to help telecommunication equipment pass Test 3 (1kV, 10/1000µs).

†See FT600 section.

4

**Table T1. Product Series: Size, Current Rating, Voltage Rating, Typical Resistance for Telecommunications and Networking Devices**

	TC250 TCF250 TGC250	TR250 TRF250	TS250	TSV250	TSL250	TS600 TSM600	TR600 TRF600	BBR	RXE	SMD, midSMD miniSMDC
<b>Voltage Rating (V)***</b> (Operating/Interrupt)	60/250	60/250	60/250	60/250	80/250	60/600 250/600	60/600 250/600	99	60 72*	60
<b>Specification</b>	ITU	ITU	ITU	ITU	Telcordia GR-1089 Intrabuilding	UL60950 Telcordia GR-1089	UL60950 Telcordia GR-1089	Cable Taps		
<b>Hold Current (A)</b>										
0.080	—	17.0Ω	—	—	8.0Ω	—	—	—	—	—
0.100	—	—	—	—	—	—	—	—	3.5Ω	—
0.110	—	7.0Ω	—	—	—	—	—	—	—	—
0.120	10.5Ω	6.0-9.5Ω	—	—	—	—	—	—	—	—
0.130	—	—	8.0-10.5Ω	5.5Ω	—	—	—	—	—	—
0.140	—	—	—	—	—	—	—	—	—	4.0Ω
0.145	7.0Ω	4.3-5.0Ω	—	—	—	—	—	—	—	—
0.150	—	—	—	—	—	—	8Ω	—	—	—
0.160	—	—	—	—	—	—	5.5-7.0Ω**	—	—	—
0.170	—	—	—	—	—	11.0Ω	—	—	4.3Ω	—
0.180	1.4Ω	1.5Ω****	—	—	—	—	—	—	—	—
0.200	—	—	—	—	—	8.5Ω	—	—	2.3Ω*	—
0.250	—	—	—	—	—	3-3.5Ω**	—	—	1.6Ω*	—
0.300	—	—	—	—	—	—	—	—	1.1Ω*	1.4-3.0Ω
0.550	—	—	—	—	—	—	—	1.05Ω	—	—
0.750	—	—	—	—	—	—	—	0.58Ω	—	—

**Notes:**

\*These devices have a maximum operating voltage of 72V

\*\*These devices have a maximum operating voltage of 250V

\*\*\*Voltage Rating for Telecommunications and Networking Devices is dependent upon the nature of the fault conditions. See below for details

\*\*\*\*These devices have a maximum operating voltage of 100V

**Voltage Ratings for Telecommunications and Networking Devices**

For Raychem Circuit Protection telecommunications devices (TC, TGC, TCF, TRx, TSx series) there are two applicable voltage ratings. These are **V<sub>MAX</sub> Operating** and **V<sub>MAX</sub> Interrupt**. To help understand the nature of these two different voltage ratings the following definitions are provided:

**V<sub>MAX</sub> Operating:** For telecommunications devices this is the voltage we have used to obtain component recognition under UL1434. Most Raychem Circuit Protection devices (TC, TGC, TCF, TRx, TRFx, TSx) are certified at 60V but can withstand higher V<sub>MAX</sub>. TR600-160 and TSM600 product families are certified at 250V but can withstand higher V<sub>MAX</sub>. Interrupt conditions as noted above.

**V<sub>MAX</sub> Interrupt:** Under specified conditions this is the highest voltage that can be applied to the device at the maximum current. Devices have been designed to trip safely under higher power level cross conditions, as listed above, to assist equipment in meeting the appropriate industry conditions.

**Table T2. Thermal Derating for Telecommunications and Networking Devices [Hold Current (A) at Ambient Temperature (°C)]**

Part Number	Maximum Ambient Temperature								
	-40°C	-20°C	0°C	20°C	40°C	50°C	60°C	70°C	85°C
<b>Chip<sup>1</sup>—60/250V</b>									
<b>TC250/TGC250/TCF250</b>									
TCF250-120T	0.186	0.165	0.143	0.120	0.099	0.088	0.077	0.066	0.050
TC250-145T	0.225	0.199	0.172	0.145	0.119	0.106	0.093	0.080	0.060
TGC250-145T	0.225	0.199	0.172	0.145	0.149	0.106	0.093	0.080	0.060
TC250-180*	0.269	0.240	0.211	0.180	0.153	0.138	0.123	0.109	0.087
<b>Leaded<sup>1</sup>—60/250V</b>									
<b>TR250/TRF250</b>									
TR250-080U	0.124	0.110	0.095	0.080	0.066	0.059	0.051	0.044	0.033
TR250-110U	0.171	0.151	0.131	0.110	0.091	0.081	0.071	0.061	0.046
TR250-120	0.186	0.165	0.143	0.120	0.099	0.088	0.077	0.066	0.050
TR250-145	0.225	0.199	0.172	0.145	0.119	0.106	0.093	0.080	0.060
TRF250-180*	0.279	0.247	0.213	0.180	0.147	0.131	0.115	0.99	0.74
<b>Surface<sup>2</sup>—80/250V</b>									
<b>TLS250</b>									
TSL250-080	0.124	0.110	0.095	0.080	0.066	0.059	0.051	0.044	0.033
<b>Surface<sup>1</sup>—60/250V</b>									
<b>TS250/TSV250</b>									
TS250-130	0.208	0.182	0.156	0.130	0.104	0.091	0.078	0.065	0.045
TSV250-130	0.208	0.182	0.156	0.130	0.104	0.091	0.078	0.065	0.045
<b>Leaded<sup>3</sup>—60/600V</b>									
<b>TR600</b>									
TRF600-150	0.233	0.206	0.178	0.150	0.143	0.124	0.11	0.096	0.083
TR600-160	0.249	0.219	0.190	0.160	0.132	0.117	0.103	0.088	0.066
<b>Surface<sup>3</sup>—60/600V</b>									
<b>TS600</b>									
TS600-170	0.264	0.230	0.200	0.170	0.140	0.125	0.109	0.094	0.070
TS600-200-RA	0.310	0.275	0.238	0.200	0.165	0.147	0.128	0.110	0.083
TSM600-250	0.400	0.350	0.300	0.250	0.198	0.170	0.141	0.117	0.083
<b>Leaded—90V</b>									
<b>BBR</b>									
BBR550*	0.850	0.750	0.650	0.550	0.450	0.400	0.350	0.300	0.220
BBR750*	1.150	1.000	0.900	0.750	0.610	0.550	0.480	0.410	0.300
<b>Leaded—60/72V</b>									
<b>RXE</b>									
RXE010*	0.160	0.140	0.110	0.100	0.080	0.072	0.067	0.050	0.040
RXE017*	0.260	0.230	0.210	0.170	0.140	0.120	0.110	0.090	0.070
RXE020*	0.310	0.270	0.240	0.200	0.160	0.140	0.130	0.110	0.080
RXE025*	0.390	0.340	0.300	0.250	0.200	0.180	0.160	0.140	0.100
RXE030*	0.470	0.410	0.360	0.300	0.240	0.220	0.200	0.160	0.120

**Notes:**

<sup>1</sup>60/250V products are designed to help equipment pass ITU specifications (K.20, K.21, etc) and Telcordia GR-1089 Intra-building power cross.

<sup>2</sup>80/250V product designed to help equipment pass Telcordia GR-1089 Intra-building power cross (120V<sub>ac</sub>/25A).

<sup>3</sup>60/600V products are designed to help equipment pass UL60950, TIA-968-A (formerly FCC Part 68) and GR1089 specifications.

\*Product is not currently available in a resistance matched or sorted option.

**Table T2. Thermal Derating for Telecommunications and Networking Devices [Hold Current (A) at Ambient Temperature (°C)] *continued***

Part Number	Maximum Ambient Temperature								
	-40°C	-20°C	0°C	20°C	40°C	50°C	60°C	70°C	85°C
<b>Surface—60 V SMD, midSMD</b>									
SMD030*	0.44	0.39	0.32	0.30	0.26	0.23	0.19	0.18	0.15
SMD030-2018*	0.48	0.42	0.35	0.30	0.24	0.21	0.17	0.15	0.10
SMD050-2018*	0.86	0.77	0.70	0.55	0.48	0.43	0.38	0.36	0.26
<b>Surface—60 V miniSMD</b>									
miniSMDC014*	0.23	0.20	0.17	0.14	0.11	0.10	0.09	0.07	0.05
miniSMDC014F*	0.23	0.20	0.17	0.14	0.11	0.10	0.09	0.07	0.05

**Notes:**

\*Product is not currently available in a resistance matched or sorted option.

**Figure T1. Thermal Derating [Hold Current (A) at Ambient Temperature (°C)]**

- A = TC250-180
- B = All other TC, TGC, TCF, TRX, TRFX, TSX, TSMx series devices

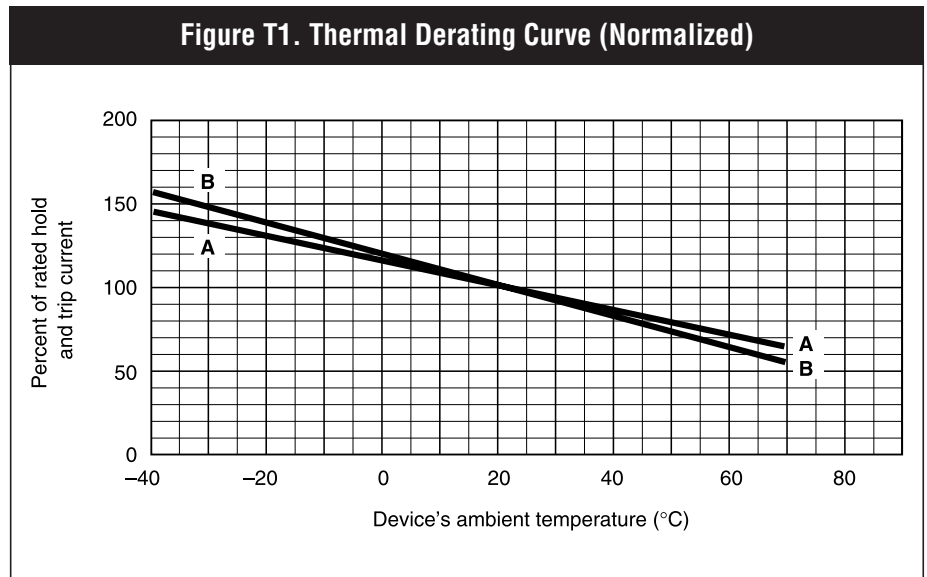

For thermal derating of BBR and RXE series devices, see radial-leaded product section on pages 217-252. For SMD, midSMD, miniSMDC series, see surface-mount product section on page 187 of this Raychem Circuit Protection Databook.





**Table T3. Electrical Characteristics for Telecommunications and Networking Devices**

Part Number	I <sub>H</sub> (A)	I <sub>T</sub> (A)	V <sub>MAX</sub> Operating (V <sub>oc</sub> )	V <sub>MAX</sub> Interrupt (V <sub>max</sub> )	I <sub>MAX</sub> (A)	Pd <sub>TYP</sub> (W)	Time-to-Trip (nom/max*)		R <sub>MIN</sub> (Ω)	R <sub>MAX</sub> (Ω)	R <sub>1 Max</sub> (Ω)	Figure for Dimensions
							(A)	(s)				
<b>Chip<sup>1</sup>—60/250V</b>												
<b>TC250/TCF250/TGC250</b>												
TCF250-120T	0.120	0.240	60	250	3.0	1.0	1.0	1.20*	6.3	12.0	18.0	T4
TC250-145T	0.145	0.290	60	250	3.0	1.0	1.0	1.50	5.0	9.0	14.0	T4
TGC250-145T	0.145	0.290	60	250	3.0	1.0	1.0	1.00	6.0	10.0	14.0	T4
TC250-180	0.180	0.500	60	250	3.0	1.0	1.0	15.00	0.8	2.0	4.0	T4
<b>Leaded<sup>1</sup>—60/250V (TRF for Pb-free version of product)</b>												
<b>TR250/TRF250</b>												
TR250-080T	0.080	0.160	60	250	3.0	1.0	0.35	3.00*	15.0	22.0	33.0	T2
TR250-080U	0.080	0.160	60	250	3.0	1.0	0.35	3.00*	14.0	20.0	33.0	T2
TR250-110U	0.110	0.220	60	250	3.0	1.0	1.0	0.75	5.0	9.0	16.0	T2
TR250-120	0.120	0.240	60	250	3.0	1.0	1.0	1.50	4.0	8.0	16.0	T3
TR250-120T	0.120	0.240	60	250	3.0	1.0	1.0	0.70	7.0	12.0	16.0	T3
TR250-120T-RA	0.120	0.240	60	250	3.0	1.0	1.0	0.70	7.0	9.0	16.0	T3
TR250-120T-RC	0.130	0.260	60	250	3.0	1.0	1.0	0.85	5.4	7.5	14.0	T3
TR250-120T-RF	0.120	0.240	60	250	3.0	1.0	1.0	0.70	6.0	10.5	16.0	T3
TR250-120T-R1	0.120	0.240	60	250	3.0	1.0	1.0	0.75	6.0	9.0	16.0	T3
TR250-120T-R2	0.120	0.240	60	250	3.0	1.0	1.0	0.70	8.0	10.5	16.0	T3
TR250-120U	0.120	0.240	60	250	3.0	1.0	1.0	1.00	6.0	10.0	16.0	T3
TR250-120UT	0.120	0.240	60	250	3.0	1.0	1.0	0.90	7.0	12.0	16.0	T3
TR250-145	0.145	0.290	60	250	3.0	1.0	1.0	2.50	3.0	6.0	14.0	T3
TR250-145-RA	0.145	0.290	60	250	3.0	1.0	1.0	2.50	3.0	5.5	12.0	T3
TR250-145-RB	0.145	0.290	60	250	3.0	1.0	1.0	2.00	4.5	6.0	14.0	T3
TR250-145T	0.145	0.290	60	250	3.0	1.0	1.0	1.00	5.4	7.5	14.0	T3
TR250-145U	0.145	0.290	60	250	3.0	1.0	1.0	2.00	3.5	6.5	12.0	T3
TRF250-180	0.180	0.650	100	250	10.0	1.5	3.0	0.5	0.8	2.2	4.0	T2
<b>Surface<sup>2</sup>—/80/250V</b>												
<b>TSL250</b>												
TSL250-080	0.080	0.160	80	250	3.0	1.2	1.0	0.80	5.0	11.0	20.0 <sup>6</sup>	T9
<b>Surface<sup>1</sup>—60/250V</b>												
<b>TS250/TSV250</b>												
TS250-130	0.130	0.260	60	250	3.0	1.1	1.0	0.9	6.5	12.0	20.0	T6
	—	—	60	650	1.1	—	—	—	—	—	—	—
TS250-130-RA	0.130	0.260	60	250	3.0	1.1	1.0	1.4	6.5	9.0	15.0	T6
	—	—	60	650	1.1	—	—	—	—	—	—	—
TS250-130-RB	0.130	0.260	60	250	3.0	1.1	1.0	0.7	9.0	12.0	20.0	T6
	—	—	60	650	1.1	—	—	—	—	—	—	—
TS250-130-RC	0.130	0.260	60	250	3.0	1.1	1.0	1.1	7.0	10.0	17.0	T6
	—	—	60	650	1.1	—	—	—	—	—	—	—
TSV250-130	0.130	0.260	60	250	3.0	1.5	1.0	2.0	4.0	7.0	12.0 <sup>6</sup>	T7

4

New



Table T3. Electrical Characteristics for Telecommunications and Networking Devices *continued*

Part Number	I <sub>H</sub> (A)	I <sub>T</sub> (A)	V <sub>MAX</sub> Operating (V <sub>DC</sub> )	V <sub>MAX</sub> Interrupt (V <sub>max</sub> )	I <sub>MAX</sub> (A)	Pd <sub>TYP</sub> (W)	Time-to-Trip (nom/max*)		R <sub>MIN</sub> (Ω)	R <sub>MAX</sub> (R <sub>TYP</sub> *)	R <sub>1 MAX</sub> (Ω)	Figure for Dimensions
							(A)	(s)				
<b>Leaded<sup>3</sup> (TRF for Pb-free version of product)</b>												
<b>TR600</b>												
<b>New</b> TRF600-150	0.150	0.300	60	600	3.0	1.0	1.0	1.4	6.0	10.0	17.0	T3
TR600-150-RA	0.150	0.300	60	600	3.0	1.0	1.0	5.0	7.0	10.0	20.0	T3
TR600-150-RB	0.150	0.300	60	600	3.0	1.0	1.0	4.5	9.0	12.0	22.0	T3
TR600-160	0.160	0.320	250	600	3.0	1.0	1.0	7.5	4.0	10.0	18.0	T3
TR600-160-RA	0.160	0.320	250	600	3.0	1.0	1.0	9.5	4.0	7.0	16.0	T3
TR600-160-R1	0.160	0.320	250	600	3.0	1.0	1.0	9.0	4.0	8.0	17.0	T3
<b>Surface<sup>3</sup>—60/600V</b>												
<b>TS600</b>												
TS600-170	0.170	0.400	60	600	3.0	2.5	1.0	10.0	4.0	9.0	18.0	T10
TS600-200-RA	0.200	0.400	60	600	3.0	2.5	1.0	12.0	4.0	7.5	13.5	T10
<b>New</b> TSM600-250	0.250	0.860	250	600	3.0	2.0	3.0	0.8	1.0	3.5*	7.0	T11
<b>New</b> TSM600-250-RA	0.250	0.860	250	600	3.0	2.0	3.0	1.0	1.0	3.0*	5.0	T11
<b>Leaded—99V</b>												
<b>BBR</b>												
<b>New</b> BBR550 <sup>4</sup>	0.550	1.1	—	99	20.0	1.5	1.6	60*	0.8	1.3	1.95	T2
<b>New</b> BBR750 <sup>4</sup>	0.750	1.5	—	99	20.0	1.7	2.0	60*	0.40	0.75	1.2	T2
<b>Leaded—60,72V</b>												
<b>RXE</b>												
RXE010 <sup>4</sup>	0.100	0.200	—	60 <sup>5</sup>	40.0	0.38	0.50	4.0*	2.50	4.50	7.50	T2
RXE017 <sup>4</sup>	0.170	0.340	—	60 <sup>5</sup>	40.0	0.48	0.85	3.0*	3.30	5.21	8.00	T2
RXE020 <sup>4</sup>	0.200	0.400	—	72 <sup>5</sup>	40.0	0.41	1.00	2.2*	1.83	2.75	4.40	T2
RXE025 <sup>4</sup>	0.250	0.500	—	72 <sup>5</sup>	40.0	0.45	1.25	2.5*	1.25	1.95	3.00	T2
RXE030 <sup>4</sup>	0.300	0.600	—	72 <sup>5</sup>	40.0	0.49	1.50	3.0*	0.88	1.33	2.10	T2
<b>Surface—60V</b>												
<b>SMD, midSMD</b>												
SMD030 <sup>4</sup>	0.300	0.600	—	60 <sup>5</sup>	10.0	1.5	1.5	3.0*	1.20	3.00*	4.8	T9
SMD030-2018 <sup>4</sup>	0.300	0.800	—	60 <sup>5</sup>	20.0	0.7	1.5	1.5*	0.50	1.40*	2.3	T8
SMD050-2018 <sup>4</sup>	0.550	1.200	—	57	10.0	1.0	2.5	5.0*	0.20	—	1.0	T8
<b>Surface—60V</b>												
<b>miniSMD</b>												
miniSMD014 <sup>4</sup>	0.140	0.340	—	60 <sup>5</sup>	10.0	0.6	1.5	0.15*	1.5	4.0*	6.0	T5
miniSMD014F <sup>4</sup>	0.140	0.340	—	60 <sup>5</sup>	10.0	0.6	1.5	0.15*	1.5	4.0*	6.0	T5

**Notes:**

<sup>1</sup>60/250V products are designed to help equipment pass ITU specifications (K.20, K.21, etc) and Telcordia GR-1089 Intrabuilding power cross.

<sup>2</sup>80/250V product designed to help equipment pass Telcordia GR-1089 Intrabuilding power cross (120V<sub>ac</sub>/25A).

<sup>3</sup>60/600V products are designed to help equipment pass UL 60950, TIA-968-A (formerly FCC part 68), and Telcordia GR-1089 specifications.

<sup>4</sup>Product is not currently available in a resistance-matched or resistance sorted option.

<sup>5</sup>Voltage rating for these products is V<sub>max</sub> operating (V<sub>DC</sub>).

<sup>6</sup>R<sub>max</sub> measured 1 hour post-trip, or 24 hours post-reflow at 20°C.

I<sub>H</sub> = Hold current: maximum current device will pass without interruption in 20°C still air.

I<sub>T</sub> = Trip current: minimum current that will switch the device from low resistance to high resistance in 20°C still air.

V<sub>max</sub> Interrupt = Maximum voltage that can be safely placed across a device in its tripped state under specified fault conditions.

I<sub>MAX</sub> = Maximum fault current device can withstand without damage at rated voltage.

P<sub>d</sub> = Power dissipated from device when in the tripped state in 20°C still air.

R<sub>max</sub> is measured one hour post-trip or post-reflow at 20°C.

R<sub>max</sub> = Maximum resistance of device as supplied at 20°C unless otherwise specified.

**Figures T2–T11. Physical Description for Dimensions for Telecommunications and Networking Devices**

**Figure T2**

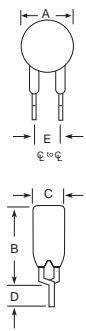

**Figure T3**

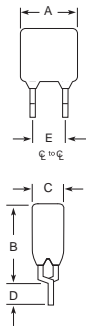

**Figure T4**

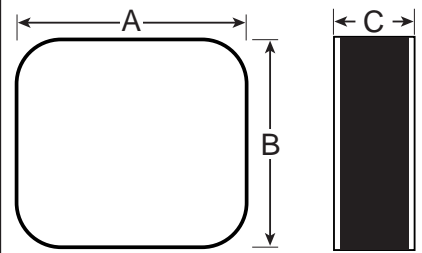

**Figure T5**

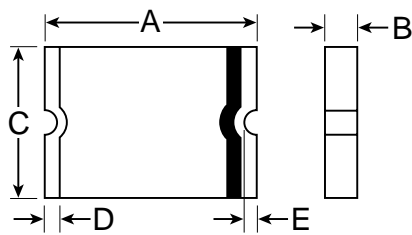

**Figure T6**

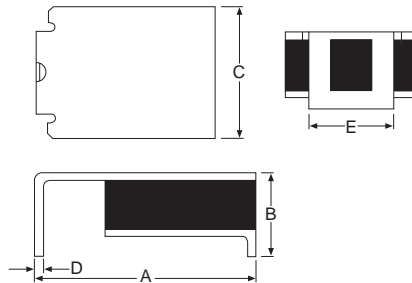

**Figure T7**

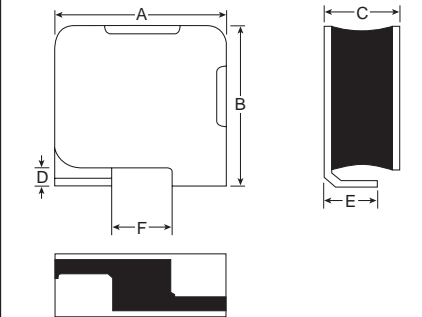

**Figure T8**

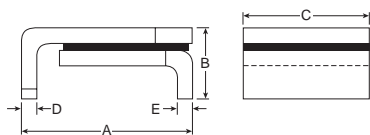

**Figure T9**

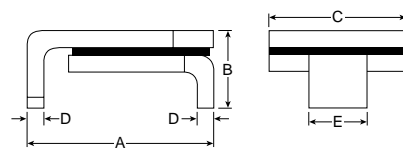

**Figure T10**

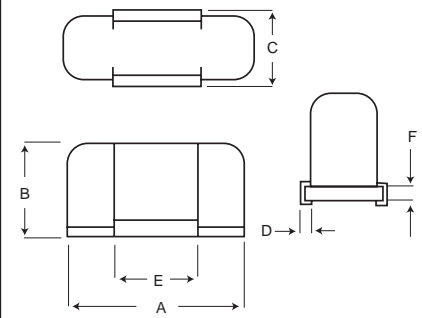

**Figure T11**

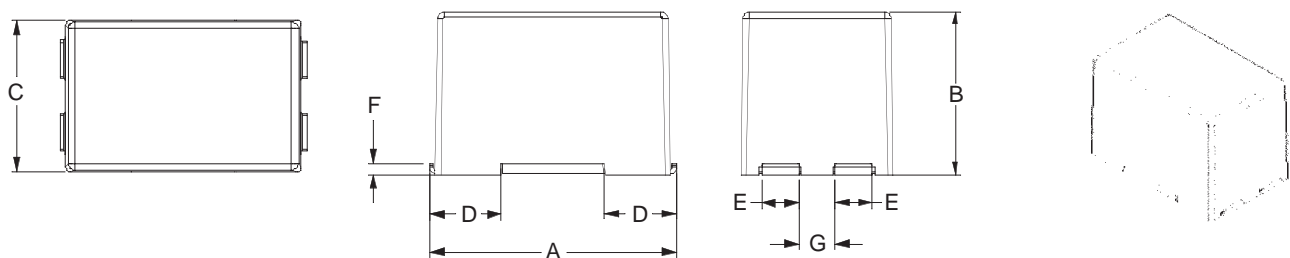

4

Table T4. Dimensions for Telecommunications and Networking Devices in Millimeters (Inches)

Part Number	Dimension														Figure
	A		B		C		D		E		F		G		
	Min.	Max.	Min.	Max.	Min.	Max.	Min.	Max.	Min.	Max.	Min.	Max.	Min.	Max.	
<b>TC/TCF/TGC—60/250V<sup>1</sup></b>															
TCF250-120T	5.4 (0.213)	5.6 (0.221)	5.4 (0.213)	5.6 (0.221)	2.0 (0.079)	2.3 (0.091)	—	—	—	—	—	—	—	—	T4
TC250-145T	5.4 (0.213)	5.6 (0.221)	5.4 (0.213)	5.6 (0.221)	2.0 (0.080)	2.5 (0.100)	—	—	—	—	—	—	—	—	T4
TGC250-145T	5.7 (0.226)	5.9 (0.234)	5.7 (0.226)	5.9 (0.234)	2.0 (0.079)	2.3 (0.091)	—	—	—	—	—	—	—	—	T4
TC250-180	9.8 (0.386)	10.4 (0.410)	6.1 (0.242)	6.6 (0.260)	2.0 (0.080)	2.5 (0.100)	—	—	—	—	—	—	—	—	T4
<b>TR250/TRF250—60/250V<sup>1</sup></b>															
TR250-080T	—	5.8 (0.228)	—	9.9 (0.390)	—	4.6 (0.181)	4.7 (0.185)	—	5.0* (0.197)	—	—	—	—	—	T2
TR250-080U	—	4.8 (0.189)	—	9.3 (0.366)	—	3.8 (0.150)	4.7 (0.185)	—	5.0* (0.197)	—	—	—	—	—	T2
TR250-110U	—	5.3 (0.210)	—	9.4 (0.370)	—	3.8 (0.150)	4.7 (0.185)	—	5.0* (0.197)	—	—	—	—	—	T2
TR250-120	—	6.5 (0.256)	—	11.0 (0.433)	—	4.6 (0.181)	4.7 (0.185)	—	5.0* (0.197)	—	—	—	—	—	T3
TR250-120U	—	6.0 (0.236)	—	10.0 (0.394)	—	3.8 (0.150)	4.7 (0.185)	—	5.0* (0.197)	—	—	—	—	—	T3
TR250-145	—	6.5 (0.256)	—	11.0 (0.433)	—	4.6 (0.181)	4.7 (0.185)	—	5.0* (0.197)	—	—	—	—	—	T3
TR250-145U	—	6.0 (0.236)	—	10.0 (0.394)	—	3.8 (0.150)	4.7 (0.185)	—	5.0* (0.197)	—	—	—	—	—	T3
TRF250-180	—	9.0 (0.354)	—	12.0 (0.412)	—	3.8 (0.150)	4.7 (0.185)	—	5.0* (0.197)	—	—	—	—	—	T2
<b>TSL250—80/250V<sup>2</sup></b>															
TSL250-080	6.7 (0.265)	7.9 (0.310)	2.7 (0.110)	3.7 (0.145)	4.8 (0.190)	5.3 (0.210)	0.2 (0.008)	0.4 (0.015)	2.5 (0.100)	3.1 (0.120)	—	—	—	—	T9
<b>TS250/TSV250—60/250V<sup>1</sup></b>															
TS250-130	8.5 (0.335)	9.4 (0.370)	—	3.4 (0.135)	—	7.4 (0.290)	0.3* (0.011)	—	3.8* (0.150)	—	—	—	—	—	T6
TSV250-130	—	6.1 (0.240)	—	6.9 (0.270)	—	3.2 (0.126)	0.56 (0.022)	—	—	1.9 (0.075)	1.6 (0.065)	2.3 (0.091)	—	—	T7
<b>TRF600/TR600—250/600<sup>3</sup></b>															
TRF600-150	—	9.0 (0.354)	—	12.5 (0.492)	—	4.6 (0.180)	4.7 (0.185)	—	5.0 (0.197)	—	—	9.0 (0.354)	—	—	T3
TR600-160	—	16.0 (0.630)	—	12.6 (0.496)	—	6.0 (0.236)	4.7 (0.185)	—	5.0* (0.197)	—	—	—	—	—	T3
<b>TS600 60/600V<sup>3</sup></b>															
TS600-170	18.2 (0.720)	19.4 (0.765)	11.5 (0.455)	12.3 (0.485)	7.2 (0.285)	8.3 (0.325)	1.6 (0.065)	2.4 (0.095)	9.9 (0.390)	10.4 (0.410)	1.5 (0.060)	2.3 (0.090)	—	—	T10
TS600-200-RA	18.2 (0.720)	19.4 (0.765)	11.5 (0.455)	12.3 (0.485)	7.2 (0.285)	8.3 (0.325)	1.6 (0.065)	2.4 (0.095)	9.9 (0.390)	10.4 (0.410)	1.5 (0.060)	2.3 (0.090)	—	—	T10
TSM600-250	—	17.6 (0.69)	—	11.7 (0.46)	—	11.2 (0.44)	—	5.2 (0.20)	—	2.8 (0.11)	0.6 (0.02)	—	2.0 (0.080)	—	T11
TSM600-250-RA	—	17.6 (0.69)	—	11.7 (0.46)	—	11.2 (0.44)	—	5.2 (0.20)	—	2.8 (0.11)	0.6 (0.02)	—	2.0 (0.080)	—	T11

**Table T4. Dimensions for Telecommunications and Networking Devices in Millimeters (Inches) *continued***

Part Number	Dimension														Figure
	A		B		C		D		E		F		G		
	Min.	Max.	Min.	Max.	Min.	Max.	Min.	Max.	Min.	Max.	Min.	Max.	Min.	Max.	
<b>BBR—90V</b>															
BBR-550	—	10.9 (0.43)	—	14.0 (0.55)	—	3.6 (0.14)	7.6 (0.30)	—	4.3 (0.17)	5.8 (0.23)	—	—	—	—	T2
BBR-750	—	11.9 (0.47)	—	15.5 (0.61)	—	3.6 (0.14)	7.6 (0.30)	—	4.3 (0.17)	5.8 (0.23)	—	—	—	—	T2
<b>RXE—60,72V</b>															
RXE010	—	7.4 (0.29)	—	11.6 (0.46)	—	3.0 (0.12)	7.6 (0.30)	—	4.3 (0.17)	5.8 (0.23)	—	—	—	—	T2
RXE017	—	7.4 (0.29)	—	12.7 (0.50)	—	3.0 (0.12)	7.6 (0.30)	—	4.3 (0.17)	5.8 (0.23)	—	—	—	—	T2
RXE020	—	7.4 (0.29)	—	11.7 (0.46)	—	3.0 (0.12)	7.6 (0.30)	—	4.3 (0.17)	5.8 (0.23)	—	—	—	—	T2
RXE025	—	7.4 (0.29)	—	12.7 (0.50)	—	3.0 (0.12)	7.6 (0.30)	—	4.3 (0.17)	5.8 (0.23)	—	—	—	—	T2
RXE030	—	7.4 (0.29)	—	12.7 (0.50)	—	3.0 (0.12)	7.6 (0.30)	—	4.3 (0.17)	5.8 (0.23)	—	—	—	—	T2
<b>midSMD—60V</b>															
SMD030	6.73 (0.265)	7.98 (0.314)	—	3.18 (0.125)	4.8 (0.19)	5.44 (0.214)	0.56 (0.022)	0.71 (0.028)	0.56 (0.022)	0.71 (0.028)	2.16 (0.085)	2.41 (0.095)	—	—	T9
SMD030-2018	4.72 (0.186)	5.44 (0.214)	—	1.78 (0.070)	4.22 (0.166)	4.93 (0.194)	0.25 (0.010)	0.36 (0.014)	0.25 (0.010)	0.36 (0.14)	0.30 (0.012)	0.46 (0.018)	—	—	T8
SMD050-2018	4.72 (0.186)	5.44 (0.214)	—	1.78 (0.070)	4.22 (0.166)	4.93 (0.194)	0.25 (0.010)	0.36 (0.014)	0.25 (0.010)	0.36 (0.14)	0.30 (0.012)	0.46 (0.018)	—	—	T8
<b>miniSMD—60V</b>															
miniSMDC014	4.37 (0.172)	4.73 (0.186)	0.635 (0.025)	0.89 (0.035)	3.07 (0.121)	3.41 (0.134)	0.30 (0.012)	—	0.25 (0.010)	0.50 (0.020)	—	—	—	—	T5
miniSMDC014F	4.37 (0.172)	4.73 (0.186)	0.635 (0.025)	0.89 (0.035)	3.07 (0.121)	3.41 (0.134)	0.30 (0.012)	—	0.25 (0.010)	0.50 (0.020)	—	—	—	—	T5

**Notes:**

\*Indicates dimension is typical, not minimum.

<sup>1</sup>60/250V products are designed to help equipment pass ITU specifications (K.20, K.21, etc) and Telcordia GR-1089 Intrabuilding power cross.<sup>2</sup>80/250V product designed to help equipment pass Telcordia GR-1089 Intrabuilding power cross (120V<sub>ac</sub>/25A).<sup>3</sup>60/600V products are designed to help equipment pass UL 60950, TIA-968-A (formerly FCC Part 68), and Telcordia GR-1089 specification.

Figures T12–T17. Typical Time-to-trip Curves at 20°C for Telecommunications and Networking Devices

**TC250/TGC250**

A = TC250-180

B = TC250-145T

C = TCF250-120T

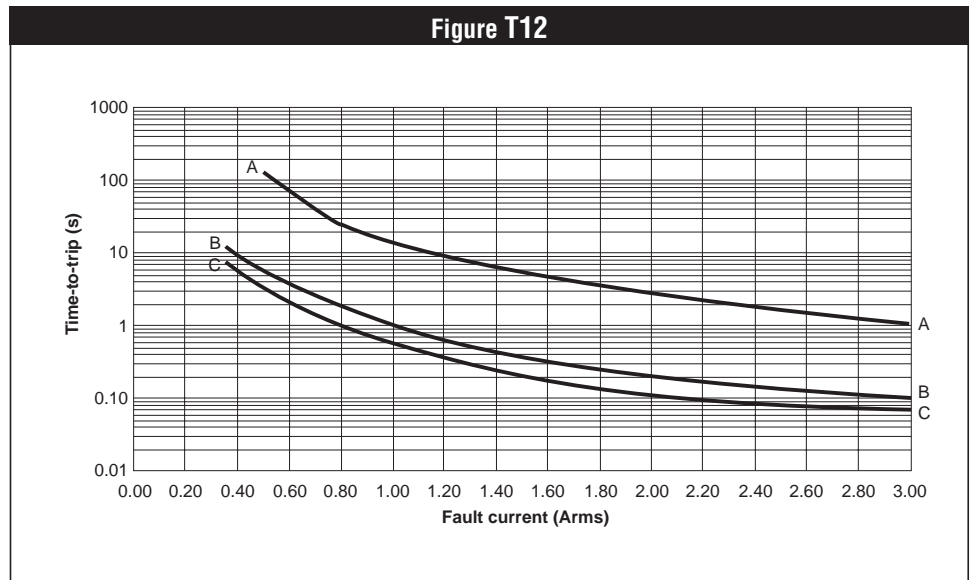

**TR/TRF250**

A = TRF250-180

B = TR250-145/145U

C = TR250-120/120U

D = TR250-110U/120UT/120T

E = TR250-080T/080U

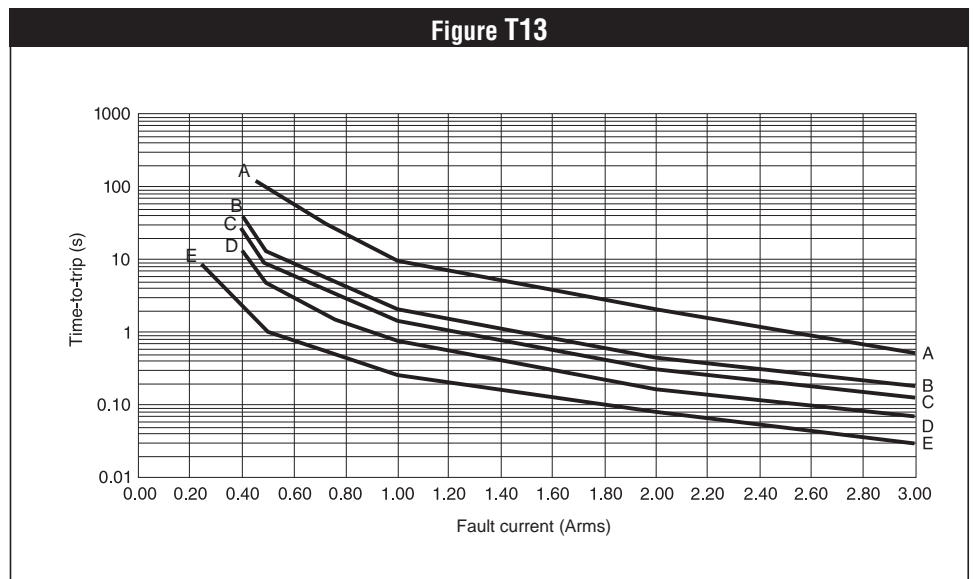

**TS250/TSV250/TSL250**

A = TSV250-130

B = TS250-130

C = TSL250-080

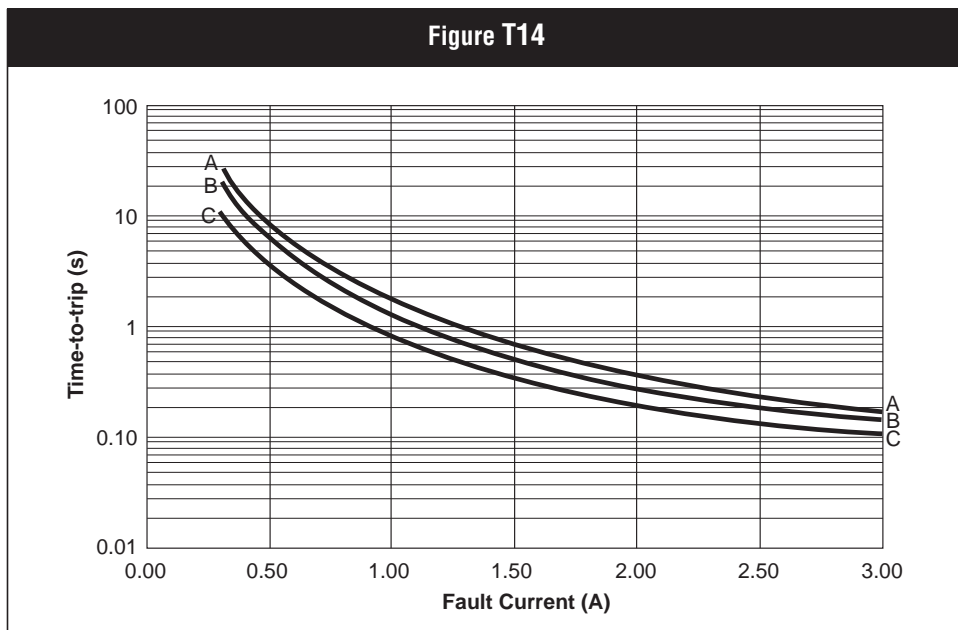

**4**

**TR600/TRF600/TS600/TSM600**

A = TSM600-250

B = TS600-170/200

C = TR600-160

D = TRF600-150

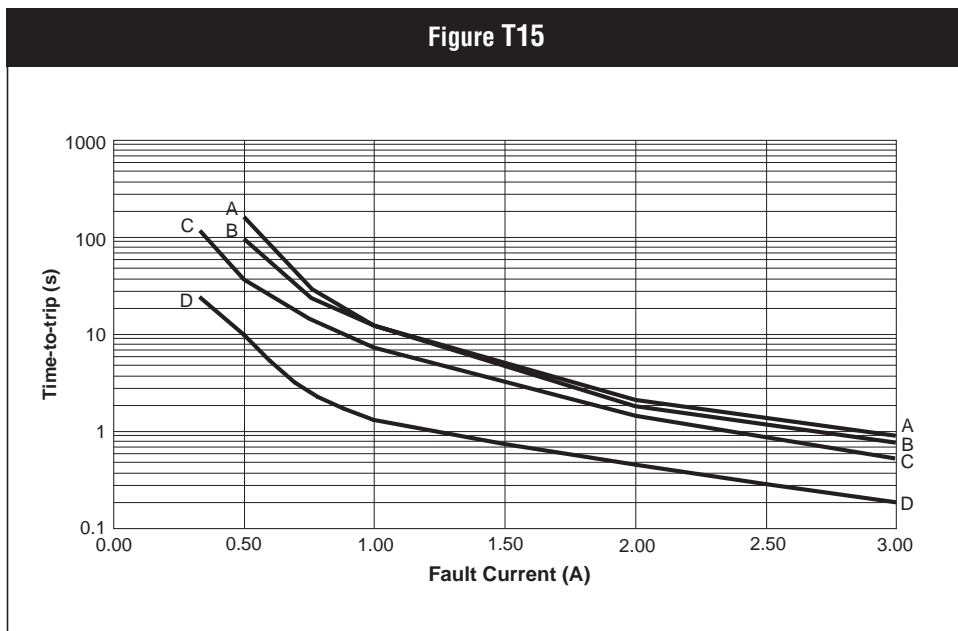

Figures T12–T17. Typical Time-to-trip Curves at 20°C for Telecommunications and Networking Devices *continued*

RXE

A = RXE010

B = RXE017

C = RXE020

D = RXE025

E = RXE030

F = BBR550

G = BBR750

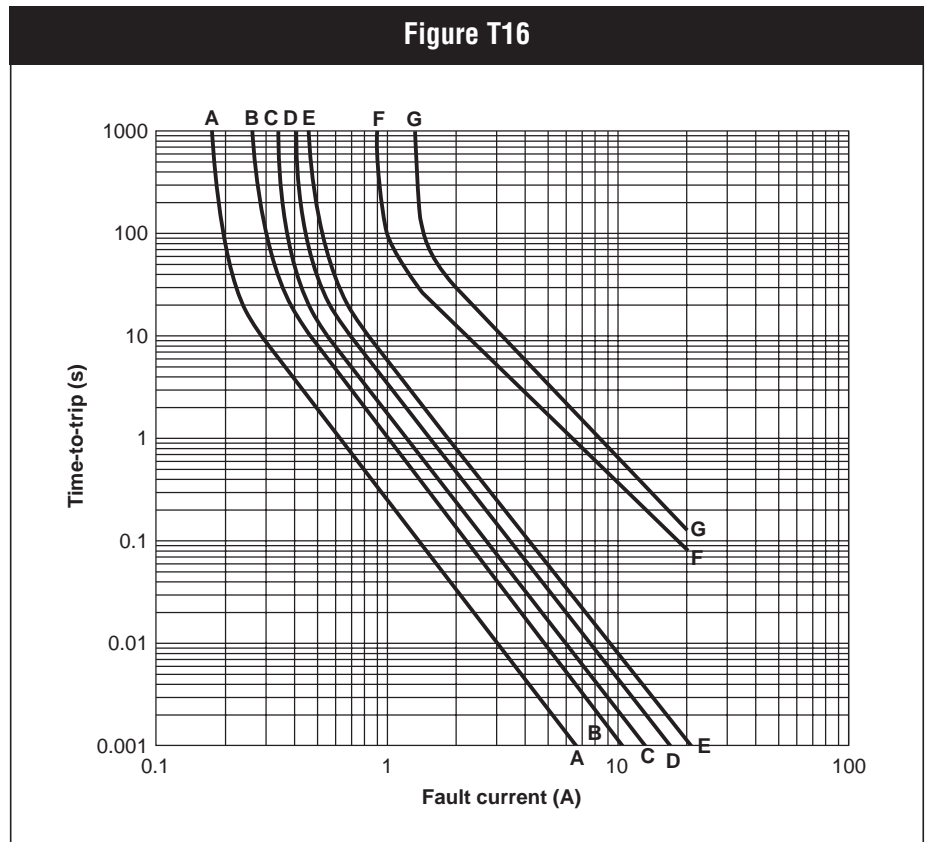

SMD/miniSMDC/midSMD

A = miniSMDC014 &  
miniSMDC014F

B = SMD030-2018

C = SMD030

D = SMD050-2018

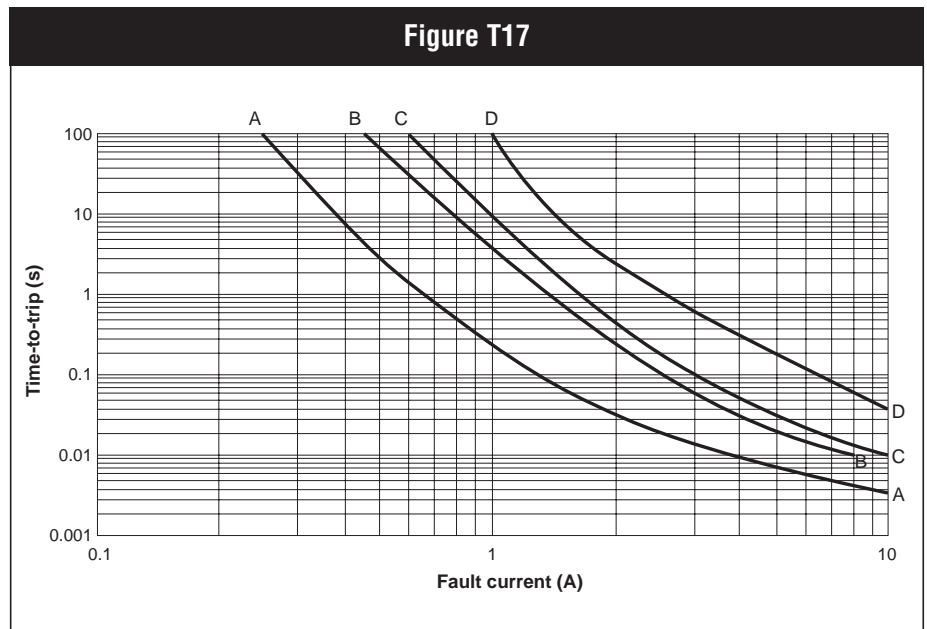



## Table T5. Physical Characteristics and Environmental Specifications for Telecommunications and Networking Devices\*

(Operating temperature range for all listed products is -40°C to 85°C)

### TC250<sup>1</sup>/TGC250<sup>1</sup>/TCF250<sup>1</sup>

#### Physical Characteristics

Terminal material	Nickel foil or tin/lead plated nickel foil
-------------------	--

#### Environmental Specifications

Test	Conditions
Passive aging	60°C, 1000 hours 85°C, 1000 hours
Humidity aging	85°C, 85% RH, 1000 hours
Thermal shock	125°C, -55°C (10 times)
Solvent resistance	MIL-STD-202, Method 215F

**Note:** Storage conditions: 40°C max., 70% RH max., devices should remain in original sealed bag prior to use. Devices may not meet specified values if these storage conditions are exceeded.

### TR250<sup>1</sup>/TRF250

#### Physical Characteristics

Lead material	Tin/lead plated copper (except TRF250: tin plated copper)
Insulating material	Cured epoxy polymer
Flammability	per IEC 695-2-2 Needle Flame Test for 20s
Soldering characteristics	ANSI/J-STD-002, Category 3
Solder heat withstand	IEC-STD 68-2-20, Test Tb, Section 5 Method 1A

**Note:** Devices are not designed to be placed through a reflow process.

#### Environmental Specifications

Test	Conditions
Passive aging	60°C, 1000 hours 85°C, 1000 hours
Humidity aging	85°C, 85% RH, 1000 hours
Thermal shock	125°C, -55°C (10 times)
Solvent resistance	MIL-STD-202, Method 215F

**Note:** Storage conditions: 40°C max., 70% RH max., devices should remain in original sealed bag prior to use. Devices may not meet specified values if these storage conditions are exceeded.

### TS250<sup>1</sup>/TSV250<sup>1</sup>/TSL250<sup>2</sup>

#### Physical Characteristics

Terminal material	Tin plated brass
Soldering characteristics	IEA 6008-2-5 Method 7

#### Environmental Specifications

Test	Conditions
Passive aging	60°C, 1000 hours 85°C, 1000 hours
Humidity aging	85°C, 85% RH, 500 hours
Thermal shock	125°C, -55°C (10 times)
Solvent resistance	MIL-STD-202, Method 215F

**Note:** Storage conditions: 40°C max., 70% RH max., devices should remain in original sealed bag prior to use. Devices may not meet specified values if these storage conditions are exceeded.

### TR600<sup>3</sup>

#### Physical Characteristics

Lead material	Tin/lead plated copper
Insulating material	Cured epoxy polymer
Flammability	per IEC 695-2-2 Needle flame test for 20s
Soldering characteristics	ANSI/J-STD-002, Category 3
Solder heat withstand	IEC-STD 68-2-20, Test Tb, Section 5 Method 1A

**Note:** Devices are not designed to be placed through a reflow process. Contact your Raychem Circuit Protection representative for TR600 series devices that are compatible with this process.



**Table T5. Physical Characteristics and Environmental Specifications for Telecommunications and Networking Devices\* continued**

(Operating temperature range for all listed products is -40°C to 85°C)

**Environmental Specifications**

Test	Conditions
Passive aging	60°C, 1000 hours 85°C, 1000 hours
Humidity aging	85°C, 85% RH, 1000 hours
Thermal shock	125°C, -55°C (10 times)
Solvent resistance	MIL-STD-202, Method 215F

**Note:** Storage conditions: 40°C max., 70% RH max., devices should remain in original sealed bag prior to use. Devices may not meet specified values if these storage conditions are exceeded.

**TS600<sup>3</sup>****Physical Characteristics**

Terminal material	Tin-plated brass
Insulating material	Nylon resin (UL94V-0), 1000V dielectric rating
Flammability	IEC 695-2-2 Needle Flame Test for 20s
Soldering characteristics	ANSI/J-STD-002, Category 3
Solder heat withstand	IEC-STD 68-2-20, Test Tb, Section 5 Method 1A

**Environmental Specifications**

Test	Conditions
Passive aging	60°C, 1000 hours 85°C, 1000 hours
Humidity aging	85°C, 85% RH, 1000 hours
Thermal shock	125°C, -55°C (10 times)
Solvent resistance	MIL-STD-202, Method 215F

**Note:** Storage conditions: 40°C max., 70% RH max., devices should remain in original sealed bag prior to use. Devices may not meet specified values if these storage conditions are exceeded.

**TSM600****Environmental Specifications**

Lead material	Tin-plated brass
Case material	Nylon resin (UL94 V-0), 1000 V dielectric rating
Lead solderability	EIC60068-2-58, Method 7
Solder heat withstand	IEC-STD 68-2-20, Test Tb, Section 5, Method 1A
Solvent resistance	MIL-STD-202, Method 215J
Flammability rating	IEC 695-2-2 Needle Flame Test for 20 s
Storage humidity	Per IPC/JEDEC J-STD-020A Level 2a

**Note:** Storage conditions: 40°C max., 70% RH max., devices should remain in original sealed bag prior to use. Devices may not meet specified values if these storage conditions are exceeded.

**BBR****Physical Characteristics**

Lead material	Tin/lead-plated copper, 0.52mm <sup>2</sup> (20AWG), ø 0.81mm (0.032 in.)
Soldering characteristics	Solderability per ANSI/J-STD-002 Category 3
Solder heat withstand	per IEC-STD 68-2-20, Test Tb, Method 1a, condition b; can withstand 10 seconds at 260°C ± 5°C
Insulating material	Cured, flame-retardant epoxy polymer; meets UL 94V-0

**Note:** \*Devices are not designed to be placed through a reflow process.

**Environmental Specifications**

Test	Conditions	Resistance Change
Passive aging	70°C, 1000 hours	±5%
	85°C, 1000 hours	±5%
Humidity aging	85°C, 85% RH, 1000 hours	±5%
Thermal shock	85°C, -40°C (10 times)	±5%
Solvent resistance	MIL-STD-202, Method 215F	No change

**Notes:** <sup>1</sup>60/250V products are designed to help equipment pass ITU specifications (K.20, K.21, etc) and Telcordia GR-1089 Intrabuilding power cross.

<sup>2</sup>80/250V product designed to help equipment pass Telcordia GR-1089 Intrabuilding power cross (120V<sub>ac</sub>/25A).

<sup>3</sup>60/600V products are designed to help equipment pass UL 60950, TIA-968-A (formerly FCC Part 68) and Telcordia GR-1089 specifications.

\*For physical and environmental characteristics of RXE, see the radial-leaded product section. For SMD, midSMD, and miniSMDC series, see surface-mount product section.

**Table T6. Packaging and Marking Information for Telecommunications and Networking Devices**

Part Number	Bag Quantity	Tape & Reel Quantity	Standard Package	Part Marking	Agency Recognition
<b>Chip<sup>1</sup>—60/250</b>					
<b>TC250/TCF250</b>					
TCF250-120T	2,500	—	10,000	—	—
TC250-145T	2,500	—	10,000	—	UL
TC250-180 <sup>4</sup>	2,500	—	10,000	—	UL
<b>Radial-leaded<sup>1</sup>—60/250V</b>					
<b>TR250/TRF250</b>					
TR250-080U	500	—	10,000	—	UL, CSA, TÜV
TR250-080U-2	—	1,500	7,500	—	UL, CSA, TÜV
TR250-080T	500	—	10,000	08	UL, CSA, TÜV
TR250-110U	500	—	10,000	—	UL, CSA, TÜV
TR250-110U-2	—	1,500	7,500	—	UL, CSA, TÜV
TR250-120	500	—	10,000	20	UL, CSA, TÜV
TR250-120-2	—	1,500	7,500	20	UL, CSA, TÜV
TR250-120T	500	—	10,000	20	UL, CSA, TÜV
TR250-120T-2	—	1,500	7,500	20	UL, CSA, TÜV
TR250-120U	500	—	10,000	20	UL, CSA, TÜV
TR250-120U-2	—	1,500	7,500	20	UL, CSA, TÜV
TR250-120UT	500	—	10,000	20	UL, CSA, TÜV
TR250-145	500	—	10,000	45	UL, CSA, TÜV
TR250-145-2	—	1,500	7,500	45	UL, CSA, TÜV
TR250-145-RA	500	—	10,000	45	UL, CSA, TÜV
TR250-145U	500	—	10,000	45	UL, CSA, TÜV
TR250-145U-2	—	1,500	7,500	45	UL, CSA, TÜV
TRF250-180 <sup>4</sup>	500	—	10,000	80	UL, CSA, TÜV
TRF250-180-2 <sup>4</sup>	—	1,500	7,500	80	UL, CSA, TÜV
<b>Surface<sup>2</sup>—80/250V</b>					
<b>TSL250</b>					
TSL250-080-2	—	1,500	7,500	T08	UL, CSA, TÜV
<b>Surface<sup>1</sup>—60/250V</b>					
<b>TS250/TSV250</b>					
TS250-130-2	—	1,500	7,500	T13	UL, CSA, TÜV
TSV250-130-2	—	1,200	6,000	T13V	UL, CSA, TÜV
<b>Radial-leaded<sup>3</sup>—60/600V</b>					
<b>TR600/TRF600</b>					
TRF600-150	500	—	10,000	150	UL, CSA
TRF600-150-2	—	1,500	7,500	150	UL, CSA
TR600-160	500	—	10,000	160	UL, CSA
TR600-160-2	—	600	3,000	160	UL, CSA

**Table T6. Packaging and Marking Information for Telecommunications and Networking Devices *continued***

Part Number	Bag Quantity	Tape & Reel Quantity	Standard Package	Part Marking	Agency Recognition
<b>Surface<sup>3</sup>—60/600V TS600/TSM600</b>					
TS600-170-2	—	300	900	T20	UL, CSA
TS600-200-RA-2	—	300	900	T20	UL, CSA
TSM600-250-2	—	200	1,000	TSM600	UL, CSA
TSM600-250-RA-2	—	200	1,000	TSM600	UL, CSA
<b>Radial<sup>4</sup>—90V BBR</b>					
BBR550	500	—	10,000	B550	UL, CSA
BBR550-2	—	1,500	7,500	B550	UL, CSA
BBR750	500	—	10,000	B750	UL, CSA
BBR750-2	—	1,500	7,500	B750	UL, CSA
<b>Radial<sup>4</sup>—60,72V RXE</b>					
RXE010	500	—	10,000	X010	UL, CSA, TÜV
RXE010-2	—	3,000	15,000	X010	UL, CSA, TÜV
RXE017	500	—	10,000	X017	UL, CSA, TÜV
RXE017-2	—	2,500	12,500	X017	UL, CSA, TÜV
RXE020	500	—	10,000	X020	UL, CSA, TÜV
RXE020-2	—	3,000	15,000	X020	UL, CSA, TÜV
RXE025	500	—	10,000	X025	UL, CSA, TÜV
RXE025-2	—	3,000	15,000	X025	UL, CSA, TÜV
RXE030	500	—	10,000	X030	UL, CSA, TÜV
RXE030-2	—	3,000	15,000	X030	UL, CSA, TÜV
<b>Surface<sup>4</sup>—60V SMD, midSMD</b>					
SMD030-2	—	2,000	10,000	030	UL, CSA, TÜV
SMD030-2018-2	—	4,000	20,000	A03	UL, CSA, TÜV
SMD050-2018-2	—	4,000	20,000	A05	UL, CSA
<b>Surface<sup>4</sup>—60V miniSMD</b>					
miniSMDC014-2	—	2,000	10,000	14	UL, CSA, TÜV
miniSMDC014F-2	—	2,000	10,000	14	UL, CSA, TÜV

**Notes:**

<sup>1</sup>60/250V products are designed to help equipment pass ITU specifications (K.20, K.21, etc) and Telcordia GR-1089 Intrabuilding power cross.

<sup>2</sup>80/250V product designed to help equipment pass Telcordia GR-1089 Intrabuilding power cross (120V<sub>ac</sub>/25A).

<sup>3</sup>60/600V products are designed to help equipment pass UL 60950, TIA-968-A (formerly FCC Part 68) and Telcordia GR-1089 specifications.

<sup>4</sup>Product is not currently available in a resistance-matched or resistance sorted option.

**Agency Recognition for Telecommunications and Networking Devices\***

UL File # E74889

CSA File #78165C

TÜV Per IEC60730-1 Certificate # for individual products available upon request.

Note: \*For agency recognition information on BBR and RXE series, see radial-leaded product section. For SMD, midSMD and miniSMDC series, see surface-mount product section.

**Table T7. Recommended Pad Layouts for Surface-mount Telecommunications and Networking Devices in millimeters (inches) Nominal**

Device	A	B	C	D	E	F	G	Figures for Dimensions
TS250 (All)	4.6 (0.18)	1.8 (0.07)	6.1 (0.24)	— —	— —	— —	— —	T18
TSV250-130	2.29 (0.09)	2.41 (0.095)	6.35 (0.25)	3.43 (0.135)	— —	— —	— —	T19
TSL250-080	3.6 (0.14)	1.8 (0.07)	5.5 (0.22)	— —	— —	— —	— —	T18
TS600 (All)	10.42 (0.410)	3.30 (0.130)	3.35 (0.132)	— —	— —	— —	— —	T18
TSM600	5.20 (0.205)	17.80 (0.701)	5.54 (0.218)	6.75 (0.266)	2.08 (0.082)	3.12 (0.123)	8.39 (0.331)	T20
SMD030-2018	4.6 (0.18)	1.5 (0.06)	3.4 (0.13)	— —	— —	— —	— —	T18
SMD030	3.1 (0.12)	2.3 (0.09)	5.1 (0.20)	— —	— —	— —	— —	T18
SMD050-2018	4.6 (0.18)	1.5 (0.06)	3.4 (0.13)	— —	— —	— —	— —	T18
miniSMDC014	3.15 (0.124)	1.78 (0.07)	3.45* (0.136*)	— —	— —	— —	— —	T18
miniSMDC014F	3.15 (0.124)	1.78 (0.07)	3.45* (0.136*)	— —	— —	— —	— —	T18

Note: \*Indicates minimum dimension.

4

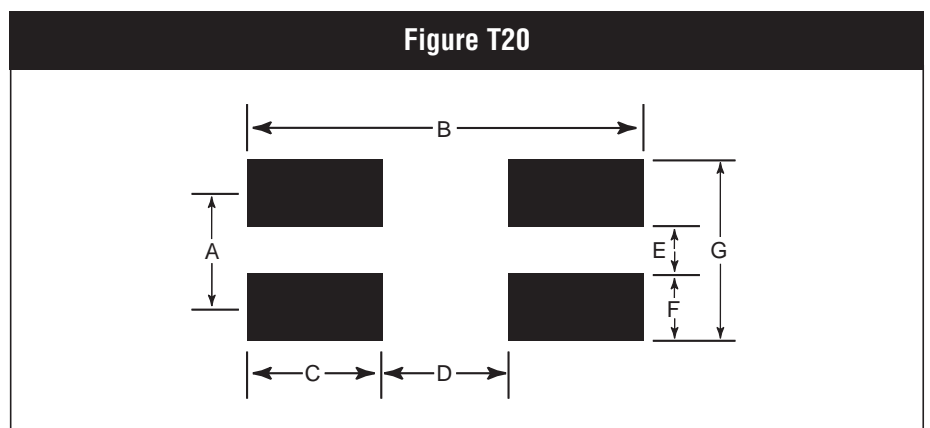
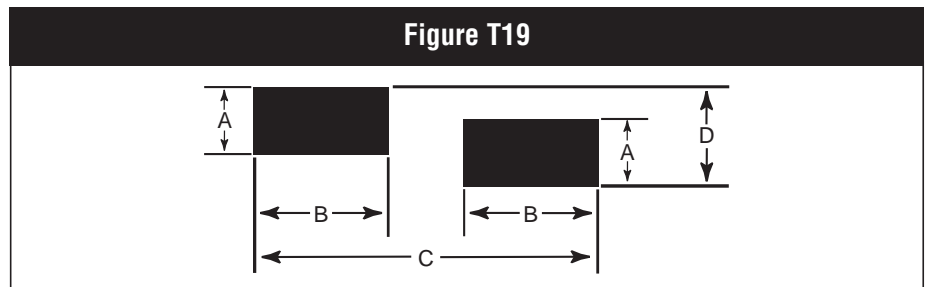
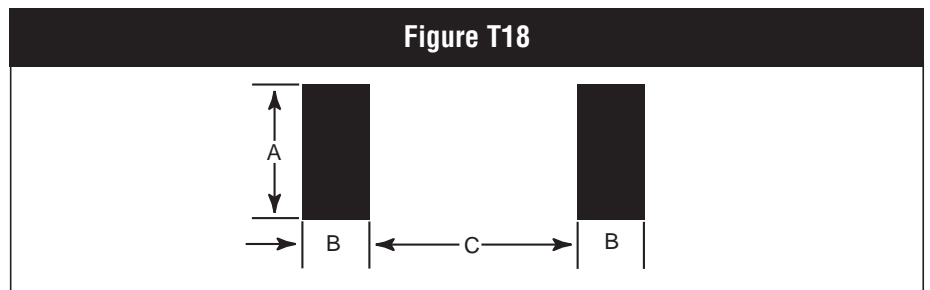

## Part Numbering System for Telecommunications and Networking Devices

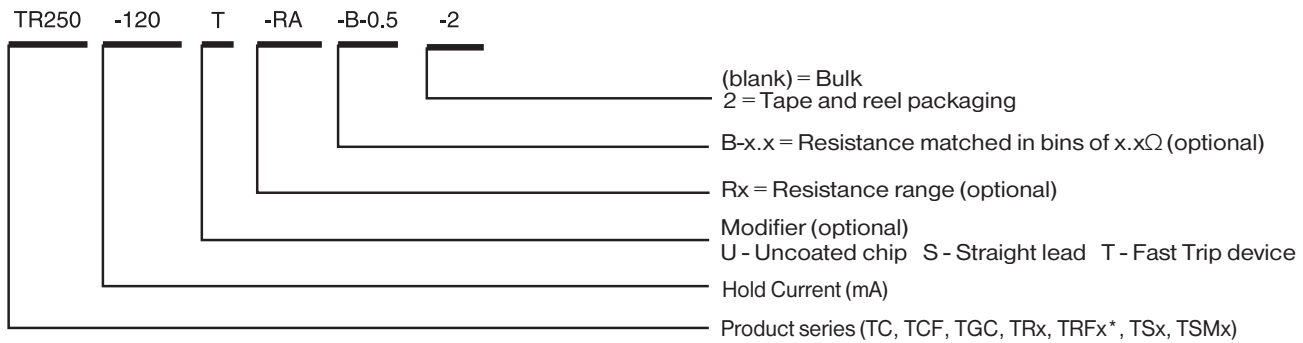

\*F = lead free

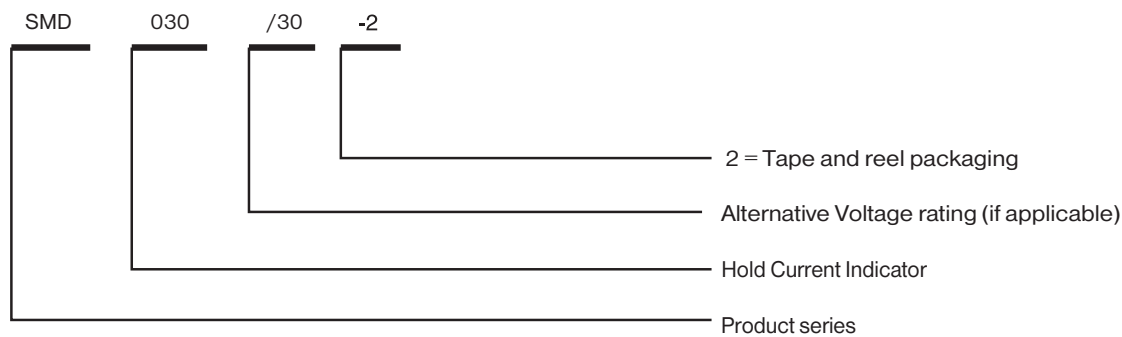

### Resistance-sorted and Resistance-matched Devices

Most TC, TCF, TGC, TR and TS devices are available in resistance-sorted and/or resistance-matched versions.

#### Resistance-sorted Devices

Resistance sorted devices (part number suffix "Rx", where x = 1, 2, A, B, C, F etc.) are supplied with resistance values that are within specified segments of the device's full range of resistance.

##### Feature

- Narrow resistance range.

##### Benefits

- Greater flexibility for design engineers.
- Lower resistance devices can allow for increased loop length on line card designs.
- Higher resistance devices may provide greater protection by offering faster time-to-trip.

#### Resistance-matched Devices

Resistance-matched devices are supplied such that all parts in one particular package (or reel) are within 0.5Ω of each other (1.0Ω for TR250-080T devices). Individual matched packages are supplied from the full resistance range of the specified device.

##### Feature

- Tighter resistance balance between any two parts in a package.

##### Benefit

- Resistance-matched devices may reduce the tip-ring resistance differential, reducing the possibility of line imbalance.

## Solder Reflow and Rework Recommendations for Telecommunications and Surface-Mount Devices

### Solder Reflow

- Recommended reflow methods: IR, vapor phase oven, hot air oven.
- Surface-mount devices are not designed to be wave soldered to the bottom side of the board (with the exception of miniSMDC014).
- Recommended maximum paste thickness of 0.25mm (0.010 in).
- Devices can be cleaned using standard industry methods and solvents.

### Rework

- If a device is removed from the board, it should be discarded and replaced with a new device.

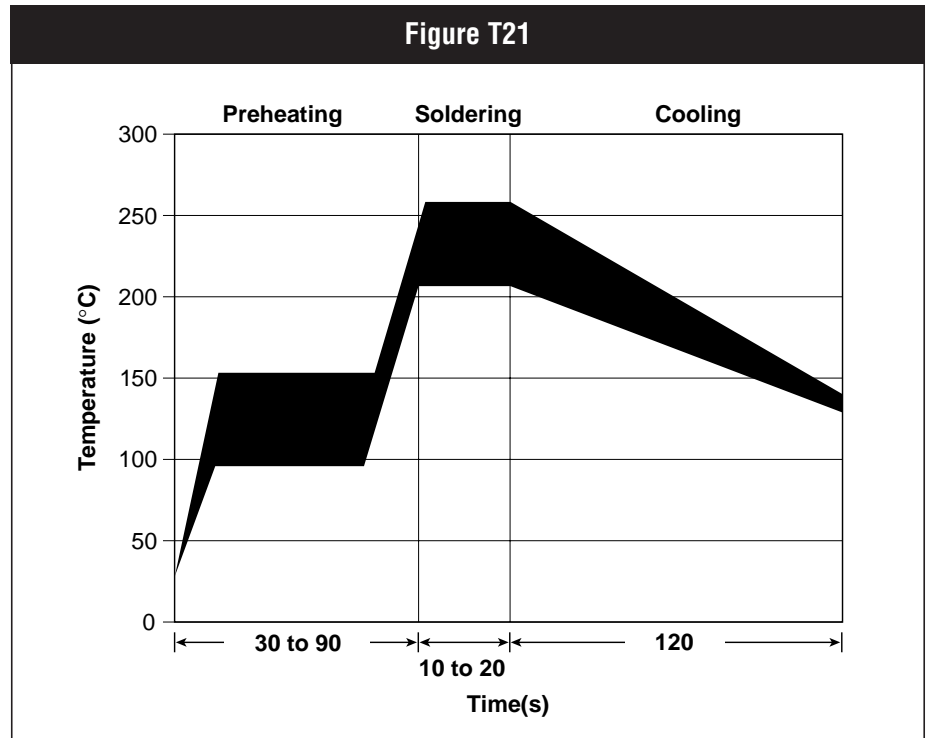

4



### CAUTION:

- If reflow temperatures exceed recommended profile, devices may not meet the performance requirements.
- Leaded devices are not designed to be compatible with reflow manufacturing operations.
- Recommended solder/temperature exposure for leaded devices is designated in the environmental/physical tables for the product family. Exposure to temperatures or duration at temperature in excess of these values may lead to device not meeting performance requirements.



**Table T8. TR250/TR600 Tape and Reel Specifications for Telecommunications and Networking Devices**

TR250/TR600 devices are available in tape and reel packaging per EIA 468-B standard. See Figures T20 and T21 for details.

Dimension Description	EIA Mark	IEC Mark	Dimensions (mm)	Tolerance
Carrier tape width	W	W	18	-0.5/+1.0
Hold down tape width	W <sub>4</sub>	W <sub>0</sub>	5	Minimum
Top distance between tape edges	W <sub>6</sub>	W <sub>2</sub>	3	Maximum
Sprocket hole position	W <sub>5</sub>	W <sub>1</sub>	9	-0.5/+0.75
Sprocket hole diameter	D <sub>0</sub>	D <sub>0</sub>	4	±0.2
Abcissa to plane (straight lead)	H	H	18.5	±3.0
Abcissa to plane (kinked lead)*	H <sub>0</sub>	H <sub>0</sub>	16	-0.5/+0.6
Abcissa to top	H <sub>1</sub>	H <sub>1</sub>	32.2	Maximum
Overall width w/lead protrusion	—	C <sub>1</sub>	43.2	Maximum
Overall width w/o lead protrusion	—	C <sub>2</sub>	42.5	Maximum
Lead protrusion	L <sub>1</sub>	L <sub>1</sub>	1.0	Maximum
Protrusion of cut-out	L	L	11	Maximum
Protrusion beyond hold down tape	I <sub>2</sub>	I <sub>2</sub>	Not specified	—
Sprocket hole pitch	P0	P0	12.7	±0.3
Device pitch: TR250	—	—	12.7	—
Device pitch: TR600	—	—	25.4	—
Pitch tolerance	—	—	20 consecutive	±1
Tape thickness	t	t	0.9	Maximum
Tape thickness with splice*	t <sub>1</sub>	—	2.0	Maximum
Splice sprocket hole alignment	—	—	0	±0.3
Body lateral deviation	Δh	Δh	0	±1.0
Body tape plane deviation	Δp	Δp	0	±1.3
Lead spacing plane deviation	ΔP <sub>1</sub>	P <sub>1</sub>	0	±0.7
Lead spacing*	F	F	5.08	±0.6
Reel width	w <sub>2</sub>	w	56	Maximum
Reel diameter	a	d	370	Maximum
Space between flanges less device	w <sub>1</sub>	—	4.75	±3.25
Arbor hole diameter	c	f	26	±12.0
Core diameter	n	h	80	Maximum
Box	—	—	56/372/372	Maximum
Consecutive missing pieces*	—	—	3 maximum	—
Empty places per reel*	—	—	Not specified	—

Note: \*Differs from EIA specification.

Figure T22. EIA Referenced Taped Component Dimensions for TR Devices

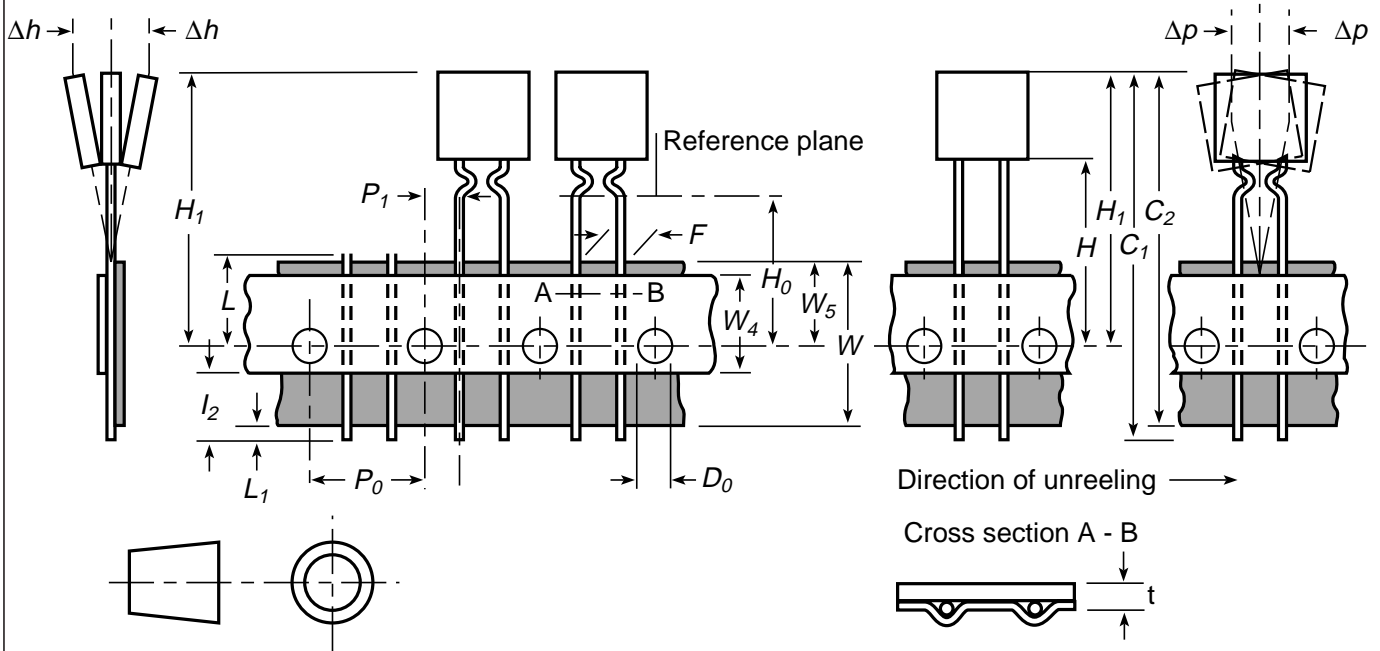

4

Figure T23. Reel Dimensions for TR Devices

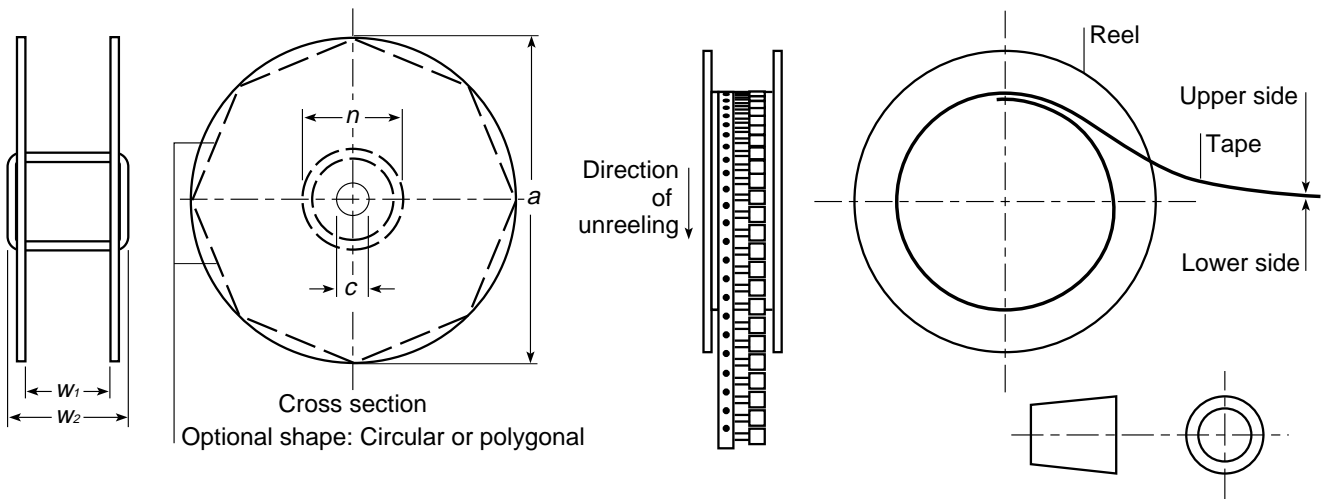

**Table T9. TS Tape and Reel Specifications for Telecommunications and Networking Devices**

TS devices are packaged per EIA 481 and EIA 481-2 standards. See Figures T22 and T23 for details.

TS250/TSL250/TSV250							
Dimension Description	EIA Mark	TS250		TSV250		TSL250	
		Dimension (mm)	Tolerance (mm)	Dimension (mm)	Tolerance (mm)	Dimension (mm)	Tolerance (mm)
Carrier tape width	W	16	±0.3	16	±0.3	16	±0.3
Sprocket hole pitch	P <sub>0</sub>	4.0	±0.10	4.0	±0.1	4.0	±0.10
	P <sub>1</sub>	12.0	±0.10	8.0	±0.1	8.0	±0.10
	P <sub>2</sub>	2.0	±0.10	2.0	±0.1	2.0	±0.10
	A <sub>0</sub>	6.9	±0.23	5.5	±0.1	5.5	±0.10
	B <sub>0</sub>	9.6	±0.15	6.2	±0.1	7.9	±0.10
Sprocket hole diameter	B <sub>1 MAX.</sub>	12.1	—	8.0	—	9.2	—
	D <sub>0</sub>	1.5	-0/+0.1	1.55	±0.05	1.55	±0.05
	F	7.5	±0.10	7.5	±0.10	7.5	±0.10
	E <sub>1</sub>	1.75	±0.10	1.75	±0.10	1.75	±0.10
	E <sub>2 MIN.</sub>	14.25	—	—	—	—	—
Tape thickness	T <sub>MAX.</sub>	0.4	—	0.45	—	0.35	—
Tape thickness with splice cover tape thickness	T <sub>1 MAX.</sub>	0.1	—	0.1	—	0.1	—
	K <sub>0</sub>	3.4	±0.15	7.00	±0.1	3.70	±0.10
	Leader min.	300	—	390	—	390	—
	Trailer min.	300	—	160	—	160	—
<b>Reel dimensions</b>							
Reel diameter	A max.	340	—	340	—	340	—
Core diameter	N min.	50	—	50	—	50	—
Space between flanges less device	W <sub>1</sub>	16.4	-0/+2.0	16.4	-0/+2.0	16.4	-0/+2.0
Reel width	W <sub>2 MAX.</sub>	22.4	—	22.4	—	22.4	—

**Table T9. TS Tape and Reel Specifications for Telecommunications and Networking Devices *continued*****TS600**

Dimension Description	EIA Mark	Dimension (mm)	Tolerance (mm)
Carrier tape width	W	32	±0.3
Sprocket hole pitch	P <sub>0</sub>	4.0	±0.1
	P <sub>1</sub>	16	±0.1
	P <sub>2</sub>	2.0	±0.1
	A <sub>0</sub>	10	±0.1
	B <sub>0</sub>	19.2	±0.1
Sprocket hole diameter	B <sub>1</sub> max.	21.6	
	D <sub>0</sub>	1.5	-0/+0.1
	F	14.2	±0.1
	E1	1.75	±0.1
Tape thickness	E <sub>2</sub> min.	28.4	±0.1
	T max.	0.50	±0.5
	T <sub>1</sub> max.	0.1	
Tape thickness with splice	K <sub>0</sub>	13.2	±0.1
	Leader min.	390	
	Trailer min.	160	

**Reel Dimensions**

Reel diameter	A max.	360	
Core diameter	N min.	50	
Space between flanges less device	W <sub>1</sub>	32.4	-0/+2.0
Reel width	W <sub>2</sub> max.	40	

**TSM600**

Dimension Description	EIA Mark	Dimension (mm)	Tolerance (mm)
Carrier tape width	W	32	±0.3
Sprocket hole pitch	P <sub>0</sub>	4.0	±0.1
	P <sub>1</sub>	24	±0.1
	P <sub>2</sub>	2.0	±0.1
	A <sub>0</sub>	11.2	±0.1
	B <sub>0</sub>	17.8	±0.1
Sprocket hole diameter	B <sub>1</sub> max.	23.45	
	D <sub>0</sub>	1.5	-0/+0.1
	F	14.2	±0.1
	E <sub>1</sub>	1.74	±0.1
Tape thickness	E <sub>2</sub> min.	28.4	±0.1
	T max.	0.5	±0.5
	T <sub>1</sub> max.	0.1	
Tape thickness with splice	K <sub>0</sub>	11.9	±0.1
	Leader min.	390	
	Trailer min.	160	

**Reel Dimensions**

Reel diameter	A max.	360	
Core diameter	N min.	50	
Space between flanges less device	W <sub>1</sub>	32.4	-0/+2.0
Reel width	W <sub>2</sub> max.	40	

Note: For tape and reel specifications for BBR and RXE devices, see radial-leaded section, page 247. For SMD, midSMD, miniSMDC see surface-mount section, page 215.



Figure T24. EIA Referenced Taped Component Dimensions for TS Devices

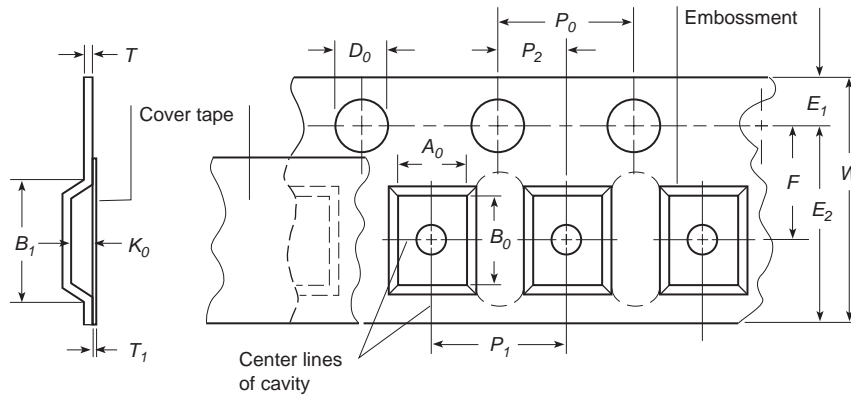
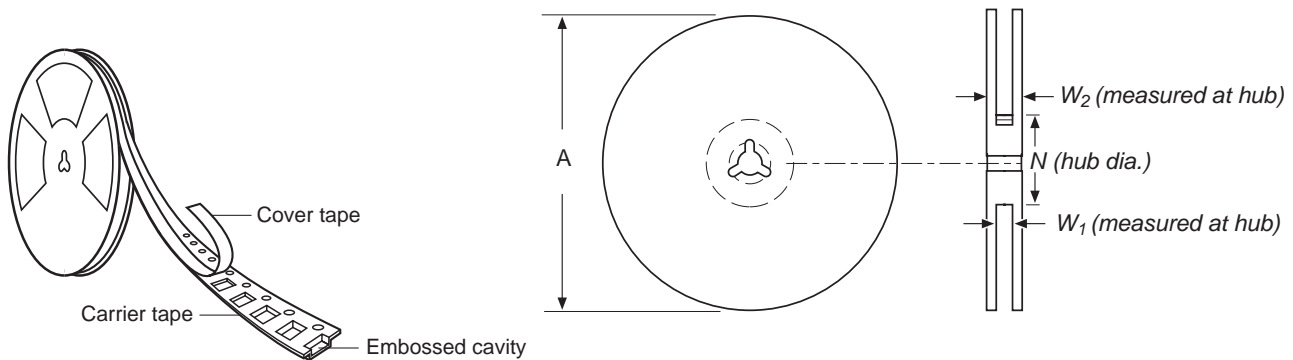

Figure T25. EIA Referenced Reel Dimensions for TS Devices



4

Latest Information

- Please visit us at [www.circuitprotection.com](http://www.circuitprotection.com) or contact your local representative for the latest information.
- Databook may contain some preliminary information. Raychem Circuit Protection, a division of Tyco Electronics, reserves the right to change any of the specifications without notice. In addition, Tyco Electronics reserves the right to make changes—without notification to Buyer—to materials or processing that do not affect compliance with any applicable specification.



## WARNING:

- Operation beyond the maximum ratings or improper use may result in device damage and possible electrical arcing and flame.
- The devices are intended for protection against occasional overcurrent or overtemperature fault conditions and should not be used when repeated fault conditions or prolonged trip events are anticipated.
- Contamination of the PPTC material with certain silicon based oils or some aggressive solvents can adversely impact the performance of the devices.
- Device performance can be impacted negatively if devices are handled in a manner inconsistent with recommended electronic, thermal, and mechanical procedures for electronic components.
- Operation in circuit with a large inductance can generate a circuit voltage ( $L \frac{di}{dt}$ ) above the rated voltage of the PolySwitch resettable device.