

## General Description

The MIC5375/6/7/8 is an advanced general purpose linear regulator offering low dropout in an ultra small package. The MIC5375/6 provides fixed output voltage in a 1mm x 1mm Thin MLF<sup>®</sup> package while the MIC5377/8 provides adjustable output voltage in a 1.2mm x 1.2mm Thin MLF<sup>®</sup> package. When the MIC5376/8 is disabled an internal resistive load is automatically applied to the output to discharge the output capacitor. The MIC5375/6/7/8 is capable of sourcing 150mA output current with low dropout making it an ideal solution for any portable electronic application.

Ideal for battery powered applications, the MIC5375/6/7/8 offers 2% initial accuracy, low dropout voltage (120mV at 150mA), and ground current (typically 29 $\mu$ A). The MIC5375/6/7/8 can also be put into a zero-off-mode current state, drawing virtually no current when disabled.

The MIC5375/6 is available in lead-free (RoHS compliant) 1mm x 1mm Thin MLF<sup>®</sup> and SC-70-5. The MIC5377/8 is available in lead-free (RoHS compliant) 1.2mm x 1.2mm Thin MLF<sup>®</sup> and SC-70-5.

The MIC5375/6/7/8 has an operating junction temperature range of  $-40^{\circ}\text{C}$  to  $125^{\circ}\text{C}$ .

Data sheets and support documentation can be found on Micrel's web site at [www.micrel.com](http://www.micrel.com).

## Features

- 4-pin 1mm x 1mm Thin MLF<sup>®</sup> package– MIC5375/6
- 8-pin 1.2mm x 1.2mm Thin MLF<sup>®</sup> package– MIC5377/8
- Low cost 5-Pin SC-70 package
- Low dropout voltage – 120mV at 150mA
- Input voltage range: 2.5V to 5.5V
- 150mA guaranteed output current
- Stable with 0402 ceramic capacitors as low as 1 $\mu$ F
- Low quiescent current – 29 $\mu$ A
- Excellent load/line transient response
- Fixed output voltages – MIC5375/6
- Adjustable output – MIC5377/8
- Output discharge circuit – MIC5376/8
- High output accuracy
  - $\pm 2\%$  initial accuracy
- Thermal shutdown and current limit protection

## Applications

- Mobile phones
- Digital cameras
- GPS, PDAs, PMP, handhelds
- Portable electronics

## Typical Application

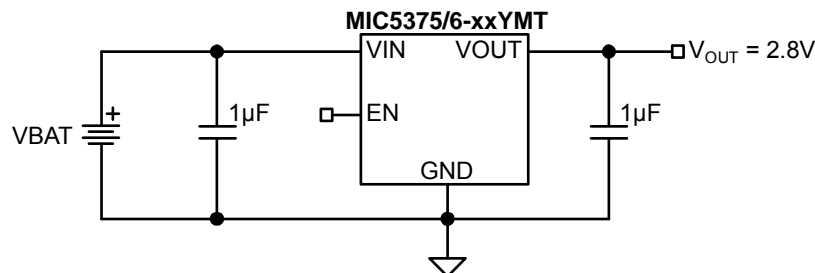

Typical Application

MLF and *MicroLeadFrame* are registered trademarks of Amkor Technology, Inc.

Micrel Inc. • 2180 Fortune Drive • San Jose, CA 95131 • USA • tel +1 (408) 944-0800 • fax + 1 (408) 474-1000 • <http://www.micrel.com>

### Block Diagram

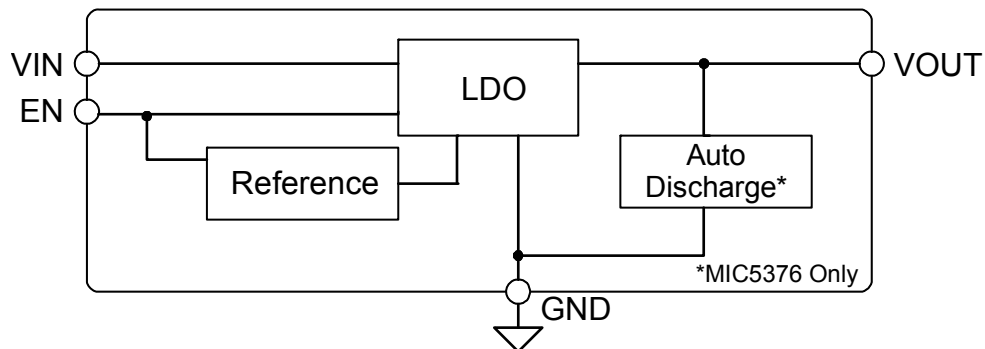

MIC5375/6 Block Diagram

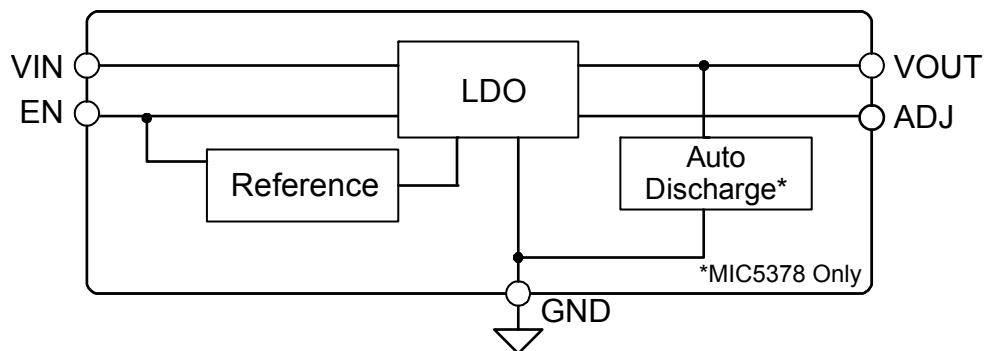

MIC5377/8 Block Diagram

## Ordering Information

Part Number	Marking Code	Output Voltage	Temperature Range	Package	Lead Finish
MIC5375-2.8YMT	J7	2.8V	-40°C to +125°C	4-Pin 1mm x 1mm Thin MLF <sup>®</sup>	Pb-Free
MIC5375-2.8YC5	<u>G</u> 7J	2.8V	-40°C to +125°C	5-Pin SC-70	Pb-Free
MIC5376-2.8YMT*	TT	2.8V	-40°C to +125°C	4-Pin 1mm x 1mm Thin MLF <sup>®</sup>	Pb-Free
MIC5376-2.8YC5*	<u>2</u> T8	2.8V	-40°C to +125°C	5-Pin SC-70	Pb-Free
MIC5377YMT	AH	ADJ	-40°C to +125°C	8-Pin 1.2mm x 1.2mm Thin MLF <sup>®</sup>	Pb-Free
MIC5377YC5	<u>A</u> HA	ADJ	-40°C to +125°C	5-Pin SC-70	Pb-Free
MIC5378YMT*	67A	ADJ	-40°C to +125°C	8-Pin 1.2mm x 1.2mm Thin MLF <sup>®</sup>	Pb-Free
MIC5378YC5*	<u>A</u> 67	ADJ	-40°C to +125°C	5-Pin SC-70	Pb-Free

### Notes:

1. Other voltages available. Contact Micrel for details.
  2. Under bar symbol (    ) may not be to scale.
  3. Thin MLF<sup>®</sup> ▲ = Pin 1 identifier.
  4. Thin MLF<sup>®</sup> is a GREEN RoHS compliant package. Lead finish is NiPdAu. Mold compound is Halogen Free.
- \* MIC5376/8 offers Auto-Discharge function.

## Pin Configuration

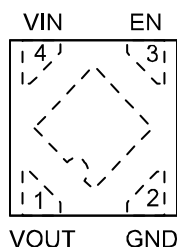

**4-Pin 1mm x 1mm Thin MLF<sup>®</sup> (MT)**  
**MIC5375/6 Fixed Output**  
**(Top View)**

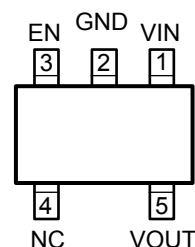

**5-Pin SC-70 (C5)**  
**MIC5375/6 Fixed Output**

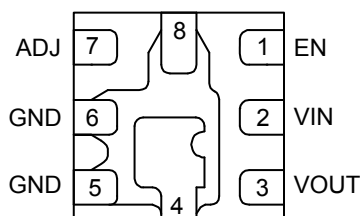

**8-Pin 1.2mm x 1.2mm Thin MLF<sup>®</sup> (MT)**  
**MIC5377/8 Adjustable Output**  
**(Bottom View)**

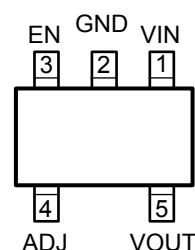

**5-Pin SC-70 (C5)**  
**MIC5377/8 Adjustable Output**

## Pin Description

Pin No. MIC5375/6 TMLF 1x1	Pin No. MIC5375/6 SC-70-5	Pin No. MIC5377/8 TMLF 1.2x1.2	Pin No. MIC5377/8 SC-70-5	Pin Name	Pin Function
3	3	1	3	EN	Enable Input. Active High. High = on, low = off. Do not leave floating.
4	1	2	1	VIN	Supply Input.
1	5	3	5	VOUT	Output Voltage.
2	2	4,5,6,8	2	GND	Ground.
–	–	7	4	ADJ	Adjust Pin: Feedback input from external divider.
–	4	–	–	NC	No connection.
HS Pad	–	–	–	EPAD	Exposed Heatsink Pad connected to ground internally.

**Absolute Maximum Ratings<sup>(1)</sup>**

Supply Voltage ( $V_{IN}$ )	0V to 6V
Enable Voltage ( $V_{EN}$ )	0V to $V_{IN}$
Power Dissipation ( $P_D$ )	Internally Limited <sup>(3)</sup>
Lead Temperature (soldering, 5 sec)	260°C
Junction Temperature ( $T_J$ )	-40°C to +125°C
Storage Temperature ( $T_S$ )	-65°C to +150°C
ESD Rating <sup>(4)</sup>	2kV

**Operating Ratings<sup>(2)</sup>**

Supply Voltage ( $V_{IN}$ )	2.5V to 5.5V
Enable Voltage ( $V_{EN}$ )	0V to $V_{IN}$
Junction Temperature ( $T_J$ )	-40°C to +125°C
Junction Thermal Resistance	
1mm x 1mm Thin MLF-4 ( $\theta_{JA}$ )	250°C/W
1.2mm x 1.2mm Thin MLF-8( $\theta_{JA}$ )	250°C/W
SC-70-5 ( $\theta_{JA}$ )	256.5°C/W

**Electrical Characteristics<sup>(5)</sup>**

$V_{IN} = V_{EN} = V_{OUT} + 1V$ ;  $C_{IN} = C_{OUT} = 1\mu F$  for  $V_{OUT} \geq 2.5V$ ,  $C_{IN} = C_{OUT} = 2.2\mu F$  for  $V_{OUT} < 2.5V$ ;  $I_{OUT} = 100\mu A$ ;  $T_J = 25^\circ C$ , **bold** values indicate -40°C to +125°C, unless noted.

Parameter	Condition	Min	Typ	Max	Units
Output Voltage Accuracy	Variation from nominal $V_{OUT}$	-2.0		+2.0	%
	Variation from nominal $V_{OUT}$	<b>-3.0</b>		<b>+3.0</b>	%
Line Regulation	$V_{IN} = V_{OUT} + 1V$ to 5.5V; $I_{OUT} = 100\mu A$		0.02	<b>0.3</b>	%
Load Regulation <sup>(6)</sup>	$I_{OUT} = 100\mu A$ to 150mA		0.3	1.0	%
Dropout Voltage <sup>(7)</sup>	$I_{OUT} = 50mA$		45	<b>100</b>	mV
	$I_{OUT} = 150mA$		120	<b>200</b>	mV
Ground Pin Current <sup>(8)</sup>	$I_{OUT} = 0mA$		29	<b>45</b>	$\mu A$
Ground Pin Current in Shutdown	$V_{EN} \leq 0.2V$		0.05	1	$\mu A$
Ripple Rejection	$f = 1kHz$ ; $C_{OUT} = 1\mu F$		60		dB
	$f = 10kHz$ ; $C_{OUT} = 1\mu F$		50		dB
Current Limit	$V_{OUT} = 0V$	200	370	550	mA
Output Voltage Noise	$C_{OUT} = 1\mu F$ , 10Hz to 100kHz		200		$\mu V_{RMS}$
Auto-Discharge NFET Resistance	$V_{EN} = 0V$ ; $V_{IN} = 3.6V$		30		$\Omega$
<b>Reference Voltage (MIC5377/8)</b>					
Reference Voltage Accuracy		<b>0.97</b>	1	<b>1.03</b>	V
Adjust Pin Input Current			0.01		$\mu A$
<b>Enable Input</b>					
Enable Input Voltage	Logic Low			<b>0.2</b>	V
	Logic High	<b>1.2</b>			V
Enable Input Current	$V_{IL} \leq 0.2V$		0.01	<b>1</b>	$\mu A$
	$V_{IH} \geq 1.2V$		0.01	<b>1</b>	$\mu A$
Turn-on Time	$C_{OUT} = 1\mu F$ ; $I_{OUT} = 150mA$		45	<b>100</b>	$\mu s$

**Notes:**

- Exceeding the absolute maximum rating may damage the device.
- The device is not guaranteed to function outside its operating rating.
- The maximum allowable power dissipation of any  $T_A$  (ambient temperature) is  $P_{D(max)} = (T_{J(max)} - T_A) / \theta_{JA}$ . Exceeding the maximum allowable power dissipation will result in excessive die temperature, and the regulator will go into thermal shutdown.
- Devices are ESD sensitive. Handling precautions recommended. Human body model, 1.5k $\Omega$  in series with 100pF.
- Specification for packaged product only.
- Regulation is measured at constant junction temperature using low duty cycle pulse testing.
- Dropout voltage is defined as the input-to-output differential at which the output voltage drops 2% below its nominal value measured at 1V differential. For outputs below 2.5V, dropout voltage is the input-to-output differential with the minimum input voltage 2.5V.
- Ground pin current is the regulator quiescent current. The total current drawn from the supply is the sum of the load current plus the ground pin current.

# Typical Characteristics

**PSRR**

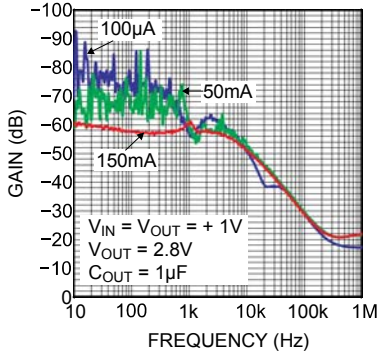

**Current Limit vs. Input Voltage**

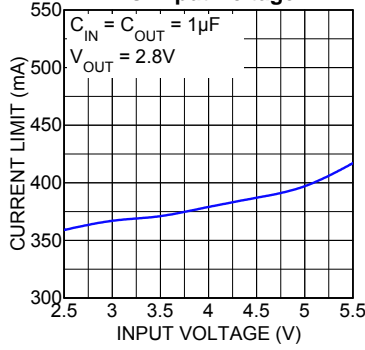

**Ground Current vs. Output Current**

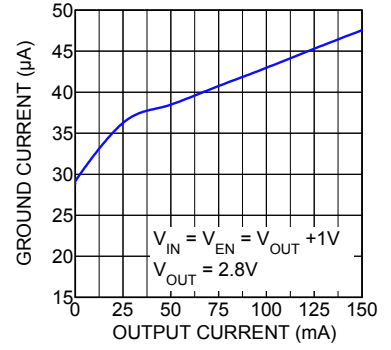

**Ground Current vs. Temperature**

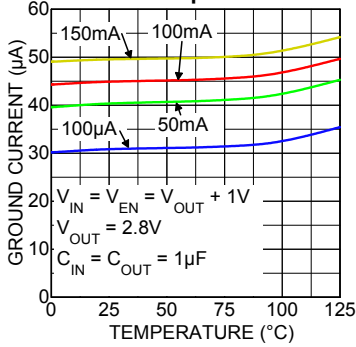

**Output Voltage vs. Load Current**

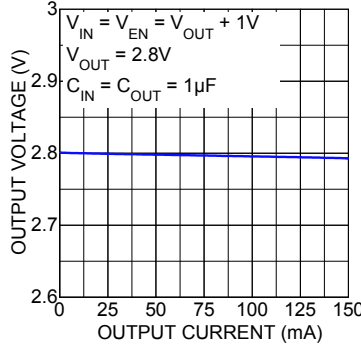

**Dropout Voltage vs. Load Current**

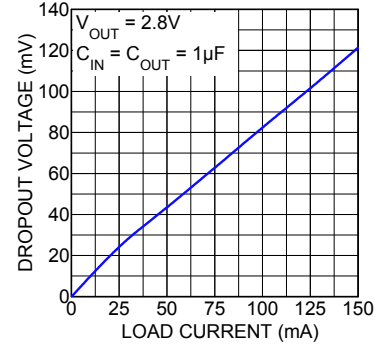

**Output Voltage vs. Supply Voltage**

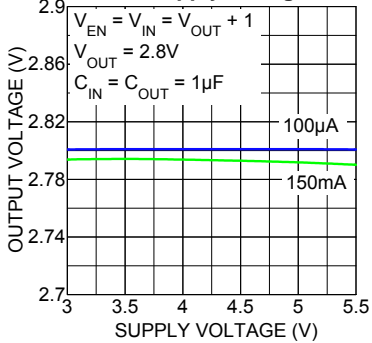

**Ground Current vs. Supply Voltage**

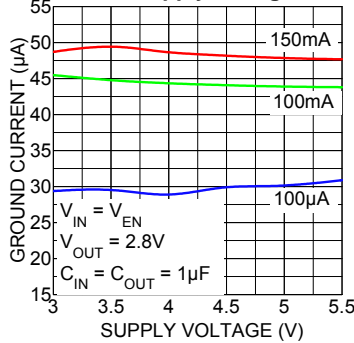

**Dropout Voltage vs. Temperature**

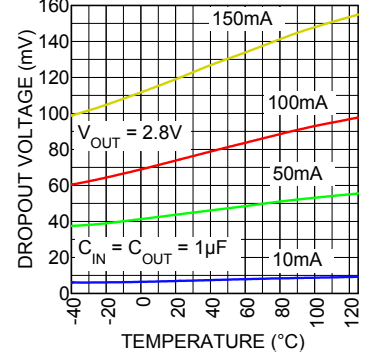

**Output Voltage vs. Temperature**

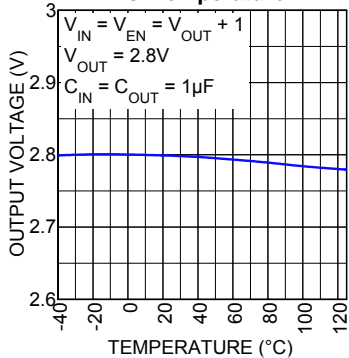

**Output Noise Spectral Density**

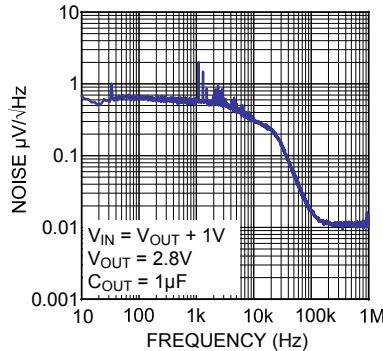

# Functional Characteristics

**Enable Turn-On**

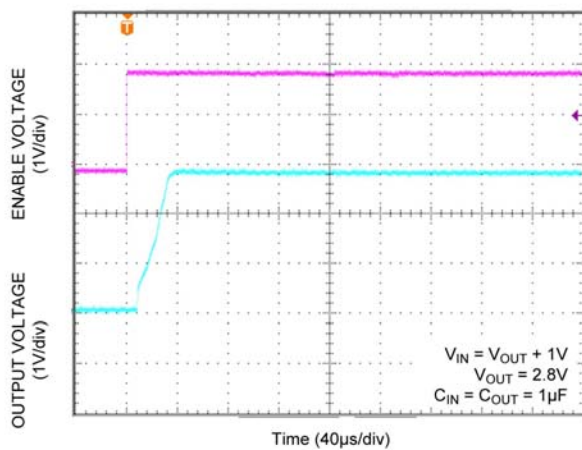

**Line Transient 2.8V (3.4V to 4.4V)**

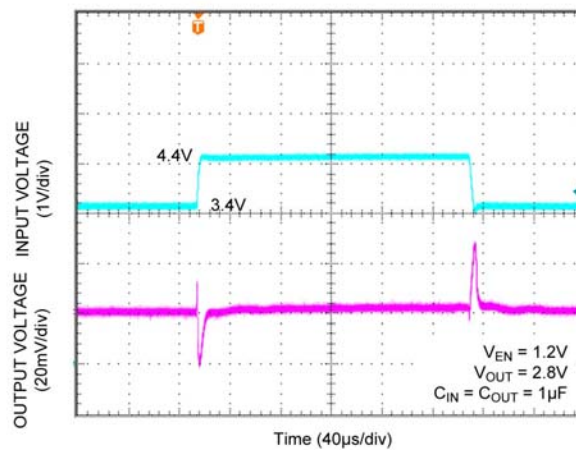

**Load Transient 2.8V (1 to 150mA)**

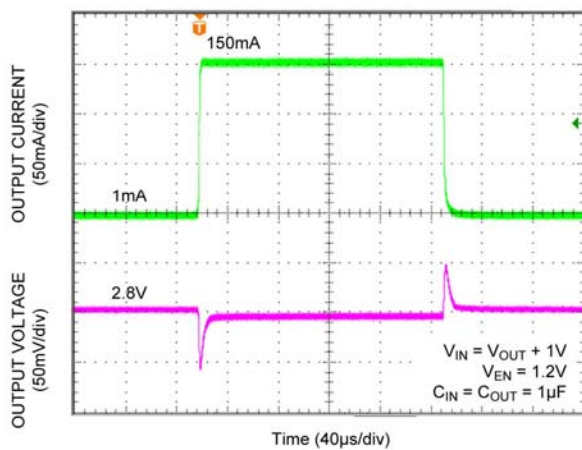

**MIC5376 Auto Discharge (No Load)**

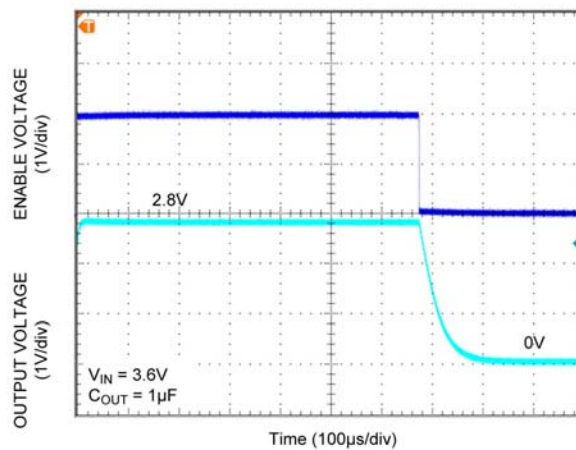

## Application Information

MIC5375/6/7/8 is Low noise 150mA LDO. The MIC5376/8 includes an auto-discharge circuit that is switched on when the regulator is disabled through the enable pin. The MIC5375/6/7/8 regulator is protected from damage due to fault conditions, offering linear current limiting and thermal shutdown.

### Input Capacitor

The MIC5375/6/7/8 is a high-performance, high bandwidth device. An input capacitor of 1 $\mu$ F is required from the input to ground to provide stability. Low-ESR ceramic capacitors provide optimal performance at a minimum of space. Additional high-frequency capacitors, such as small-valued NPO dielectric-type capacitors, help filter out high-frequency noise and are good practice in any RF-based circuit. X5R or X7R dielectrics are recommended for the input capacitor. Y5V dielectrics lose most of their capacitance over temperature and are therefore, not recommended.

### Output Capacitor

For output voltages  $\geq 2.5V$ , the MIC5375/6/7/8 requires a minimum 1 $\mu$ F output capacitor. For output voltages below 2.5V a 2.2 $\mu$ F minimum output capacitor is required. The design is optimized for use with low-ESR ceramic chip capacitors. High ESR capacitors are not recommended because they may cause high frequency oscillation. The output capacitor can be increased, but performance does not improve significantly with larger capacitance.

X7R/X5R dielectric-type ceramic capacitors are recommended because of their temperature performance. X7R-type capacitors change capacitance by 15% over their operating temperature range and are the most stable type of ceramic capacitors. Z5U and Y5V dielectric capacitors change value by as much as 50% and 60%, respectively, over their operating temperature ranges. To use a ceramic chip capacitor with Y5V dielectric, the value must be much higher than an X7R ceramic capacitor to ensure the same minimum capacitance over the equivalent operating temperature range.

### No-Load Stability

Unlike many other voltage regulators, the MIC5375/6/7/8 will remain stable and in regulation with no load. This is especially important in CMOS RAM keep-alive applications.

### Enable/Shutdown

The MIC5375/6/7/8 is provided with an active-high enable pin that allows the regulator to be disabled. Forcing the enable pin low disables the regulator and sends it into a “zero” off-mode-current state. In this state, current consumed by the regulator goes nearly to zero. Forcing the enable pin high enables the output voltage. The active-high enable pin uses CMOS technology and the enable pin cannot be left floating; a floating enable pin may cause an indeterminate state on the output.

### Adjustable Regulator Design

The MIC5377/8 adjustable version allows setting the output voltage down to 1V with the use of two external feedback resistors.

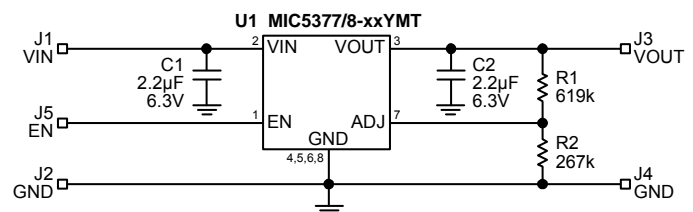

$$V_{OUT} = V_{REF} \left( 1 + \frac{R_1}{R_2} \right)$$

### Thermal Considerations

The MIC5375/6/7/8 is designed to provide 150mA of continuous current in a very small package. Maximum ambient operating temperature can be calculated based on the output current and the voltage drop across the part. For example if the input voltage is 3.6V, the output voltage is 2.8V, and the output current = 150mA. The actual power dissipation of the regulator circuit can be determined using the equation:

$$P_D = (V_{IN} - V_{OUT1}) I_{OUT} + V_{IN} I_{GND}$$

Because this device is CMOS and the ground current is typically <100 $\mu$ A over the load range, the power dissipation contributed by the ground current is < 1% and can be ignored for this calculation.

$$P_D = (3.6V - 2.8V) \times 150mA$$

$$P_D = 0.12W$$

To determine the maximum ambient operating temperature of the package, use the junction-to-ambient thermal resistance of the device and the following basic equation:

$$P_{D(max)} = \left( \frac{T_{J(max)} - T_A}{\theta_{JA}} \right)$$

$T_{J(max)} = 125^\circ C$ , the maximum junction temperature of the die,  $\theta_{JA}$  thermal resistance = 250 $^\circ C/W$  for the YMT package and 256.5 $^\circ C/W$  for the SC-70-5 package.



Substituting  $P_D$  for  $P_{D(max)}$  and solving for the ambient operating temperature will give the maximum operating conditions for the regulator circuit. The junction-to-ambient thermal resistance for the minimum footprint is  $250^{\circ}\text{C}/\text{W}$ .

The maximum power dissipation must not be exceeded for proper operation.

For example, when operating the MIC5375-2.8YMT at an input voltage of 3.6V and 150mA load with a minimum footprint layout, the maximum ambient operating temperature  $T_A$  can be determined as follows:

$$0.12\text{W} = (125^{\circ}\text{C} - T_A)/(250^{\circ}\text{C}/\text{W})$$

$$T_A = 95^{\circ}\text{C}$$

Therefore the maximum ambient operating temperature of  $95^{\circ}\text{C}$  is allowed in a 1mm x 1mm TMLF<sup>®</sup> package. For a full discussion of heat sinking and thermal effects on voltage regulators, refer to the "Regulator Thermals" section of *Micrel's Designing with Low-Dropout Voltage Regulators* handbook. This information can be found on Micrel's website at:

[http://www.micrel.com/\\_PDF/other/LDOBk\\_ds.pdf](http://www.micrel.com/_PDF/other/LDOBk_ds.pdf)

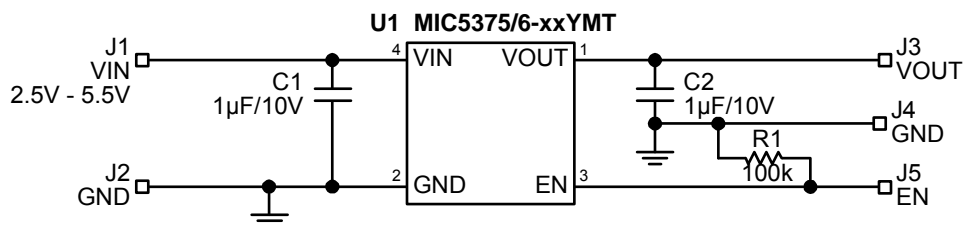

### Bill of Materials

Item	Part Number	Manufacturer	Description	Qty.
C1, C2	GRM155R61A105KE15D	Murata <sup>(1)</sup>	Capacitor, 1µF Ceramic, 10V, X5R, Size 0402	2
	C1005X5R1A105K	TDK <sup>(2)</sup>		
	0402ZD105MAT	AVX <sup>(3)</sup>		
R1	CRCW0603100KFKEA	Vishay <sup>(4)</sup>	Resistor, 100k, 1%, 1/16W, Size 0603	1
U1	MIC5375/6-xxYMT	Micrel, Inc. <sup>(5)</sup>	High Performance 150mA LDO, 4 Pin 1mm x 1mm Thin MLF®	1

**Notes:**

1. Murata: [www.murata.com](http://www.murata.com)
2. TDK: [www.tdk.com](http://www.tdk.com)
3. AVX: [www.avx.com](http://www.avx.com)
4. Vishay: [www.vishay.com](http://www.vishay.com)
5. Micrel, Inc.: [www.micrel.com](http://www.micrel.com)

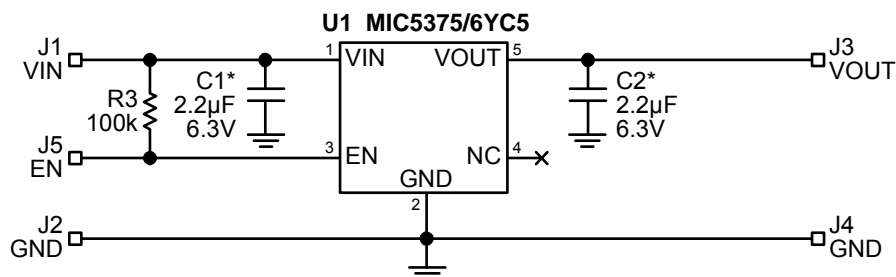

### Bill of Materials

Item	Part Number	Manufacturer	Description	Qty.
C1, C2	JMK105BJ225MV-F	Taiyo Yuden <sup>(1)</sup>	Capacitor, 2.2µF, 6.3V, X5R, Size 0402	2
	GRM155R60G225ME15D	Murata <sup>(2)</sup>		
	CV05X5R225K10AB	AVX/Kyocera <sup>(3)</sup>		
C1, C2	GRM155R61A105KE15D	Murata <sup>(1)</sup>	Capacitor, 1µF Ceramic, 10V, X5R, Size 0402	2
	C1005X5R1A105KT	TDK <sup>(2)</sup>		
	CV05X5R105K10AH	AVX/Kyocera <sup>(3)</sup>		
R1	CRCW0402619KFKEA	Vishay <sup>(4)</sup>	Resistor, 619kΩ, 1%, 1/16W, Size 0402	1
R2	CRCW04022673KFKEA	Vishay <sup>(4)</sup>	Resistor, 267kΩ, 1%, 1/16W, Size 0402	1
R3	CRCW04021003KFKEA	Vishay <sup>(4)</sup>	Resistor, 100kΩ, 1%, 1/16W, Size 0402	1
<b>U1</b>	<b>MIC5375/6YC5</b>	<b>Micrel, Inc.</b> <sup>(5)</sup>	<b>High Performance 150mA LDO, 5-Pin SC-70</b>	<b>1</b>

**Notes:**

1. Taiyo Yuden:

2. Murata: [www.murata.com](http://www.murata.com)

3. AVX/Kyocera: [www.avx.com](http://www.avx.com)

4. Vishay: [www.vishay.com](http://www.vishay.com)

5. **Micrel, Inc.:** [www.micrel.com](http://www.micrel.com)

\*  $C_{IN} = C_{OUT} = 1\mu F$  for  $V_{out} \geq 2.5V$ ,  $C_{IN} = C_{OUT} = 2.2\mu F$  for  $V_{OUT} < 2.5V$

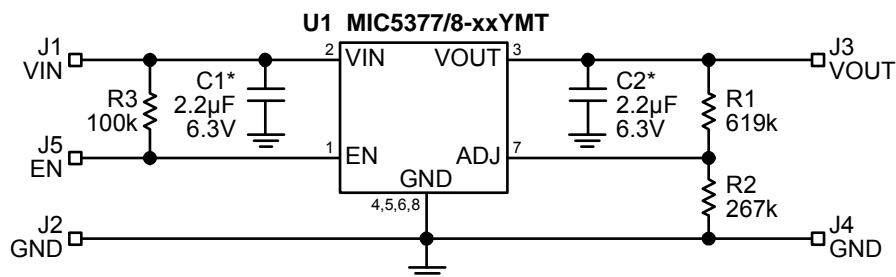

## Bill of Materials

Item	Part Number	Manufacturer	Description	Qty.
C1, C2	JMK105BJ225MV-F	Taiyo Yuden <sup>(1)</sup>	Capacitor, 2.2µF, 6.3V, X5R, Size 0402	2
	GRM155R60G225ME15D	Murata <sup>(2)</sup>		
	CV05X5R225K10AB	AVX/Kyocera <sup>(3)</sup>		
C1, C2	GRM155R61A105KE15D	Murata <sup>(1)</sup>	Capacitor, 1µF Ceramic, 10V, X5R, Size 0402	2
	C1005X5R1A105KT	TDK <sup>(2)</sup>		
	CV05X5R105K10AH	AVX/Kyocera <sup>(3)</sup>		
R1	CRCW0402619KFKEA	Vishay <sup>(4)</sup>	Resistor, 619kΩ, 1%, 1/16W, Size 0402	1
R2	CRCW04022673KFKEA	Vishay <sup>(4)</sup>	Resistor, 267kΩ, 1%, 1/16W, Size 0402	1
R3	CRCW04021003KFKEA	Vishay <sup>(4)</sup>	Resistor, 100kΩ, 1%, 1/16W, Size 0402	1
<b>U1</b>	<b>MIC5377/8-xxYMT</b>	<b>Micrel, Inc.</b> <sup>(5)</sup>	<b>High Performance 150mA LDO, 8 Pin 1.2mm x 1.2mm Thin MLF<sup>®</sup></b>	<b>1</b>

### Notes:

- Taiyo Yuden:
- Murata: [www.murata.com](http://www.murata.com)
- AVX/Kyocera: [www.avx.com](http://www.avx.com)
- Vishay: [www.vishay.com](http://www.vishay.com)
- Micrel, Inc.:** [www.micrel.com](http://www.micrel.com)

\*  $C_{IN} = C_{OUT} = 1\mu\text{F}$  for  $V_{out} \geq 2.5\text{V}$ ,  $C_{IN} = C_{OUT} = 2.2\mu\text{F}$  for  $V_{out} < 2.5\text{V}$

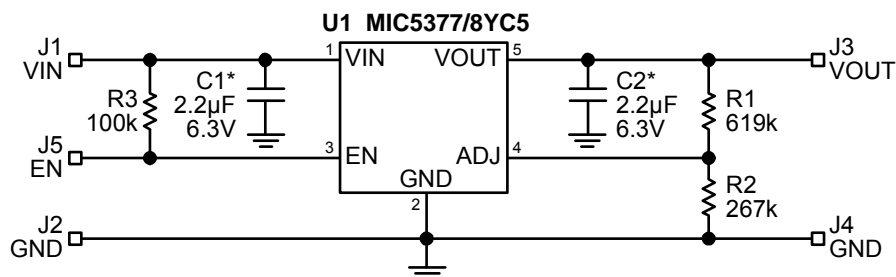

## Bill of Materials

Item	Part Number	Manufacturer	Description	Qty.
C1, C2	JMK105BJ225MV-F	Taiyo Yuden <sup>(1)</sup>	Capacitor, 2.2µF, 6.3V, X5R, Size 0402	2
	GRM155R60G225ME15D	Murata <sup>(2)</sup>		
	CV05X5R225K10AB	AVX/Kyocera <sup>(3)</sup>		
C1, C2	GRM155R61A105KE15D	Murata <sup>(1)</sup>	Capacitor, 1µF Ceramic, 10V, X5R, Size 0402	2
	C1005X5R1A105KT	TDK <sup>(2)</sup>		
	CV05X5R105K10AH	AVX/Kyocera <sup>(3)</sup>		
R1	CRCW0402619KFKEA	Vishay <sup>(4)</sup>	Resistor, 619kΩ, 1%, 1/16W, Size 0402	1
R2	CRCW04022673KFKEA	Vishay <sup>(4)</sup>	Resistor, 267kΩ, 1%, 1/16W, Size 0402	1
R3	CRCW04021003KFKEA	Vishay <sup>(4)</sup>	Resistor, 100kΩ, 1%, 1/16W, Size 0402	1
<b>U1</b>	<b>MIC5377/8YC5</b>	<b>Micrel, Inc.</b> <sup>(5)</sup>	<b>High Performance 150mA LDO, 5-Pin SC-70</b>	<b>1</b>

### Notes:

1. Taiyo Yuden:

2. Murata: [www.murata.com](http://www.murata.com)

3. AVX/Kyocera: [www.avx.com](http://www.avx.com)

4. Vishay: [www.vishay.com](http://www.vishay.com)

5. **Micrel, Inc.:** [www.micrel.com](http://www.micrel.com)

\*  $C_{IN} = C_{OUT} = 1\mu\text{F}$  for  $V_{out} \geq 2.5\text{V}$ ,  $C_{IN} = C_{OUT} = 2.2\mu\text{F}$  for  $V_{OUT} < 2.5\text{V}$

### PCB Layout Recommendations (1mm x 1mm 4-Pin Thin MLF<sup>®</sup>) Fixed

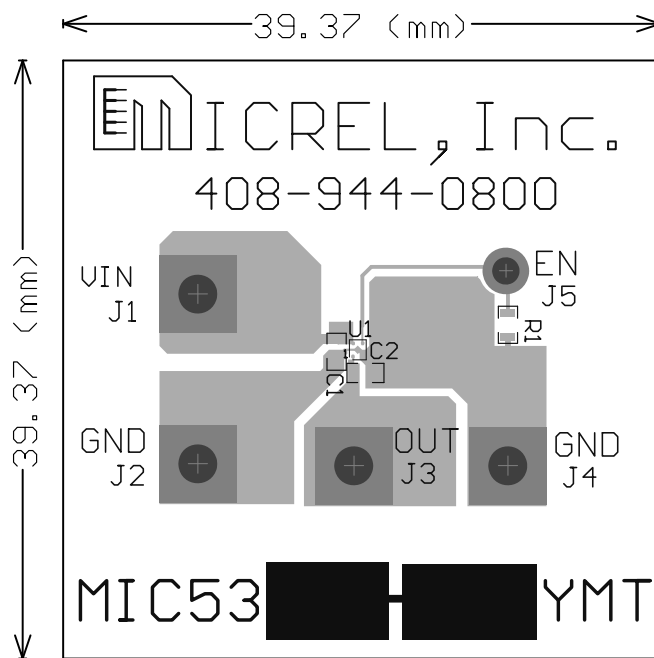

Top Layer

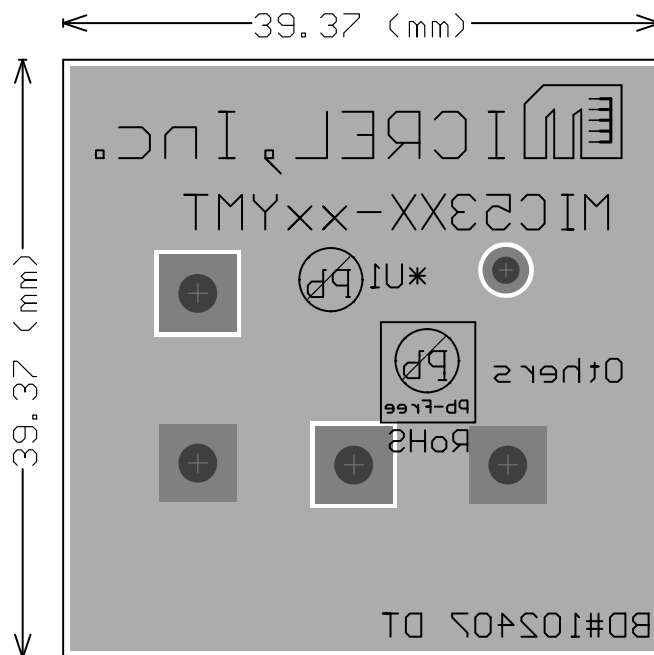

Bottom Layer

### PCB Layout Recommendations (1.2mm x 1.2mm 8-Pin Thin MLF<sup>®</sup>) Adjustable

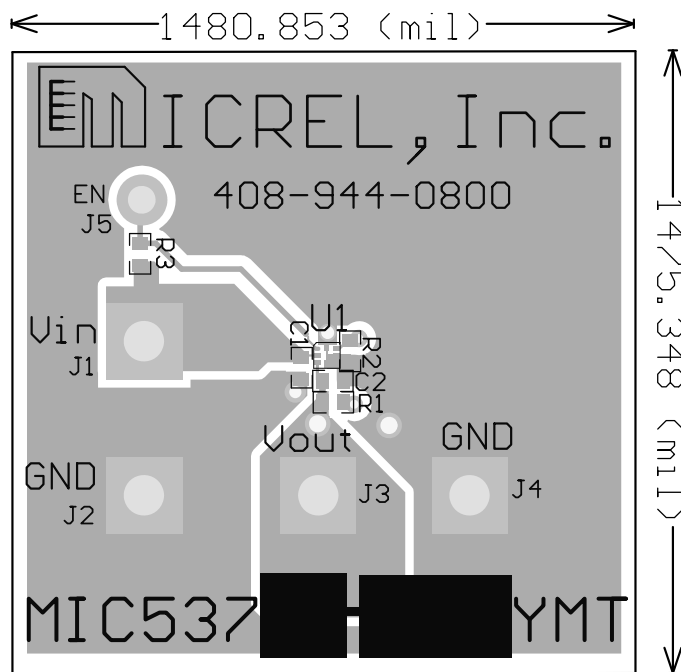

Top Layer

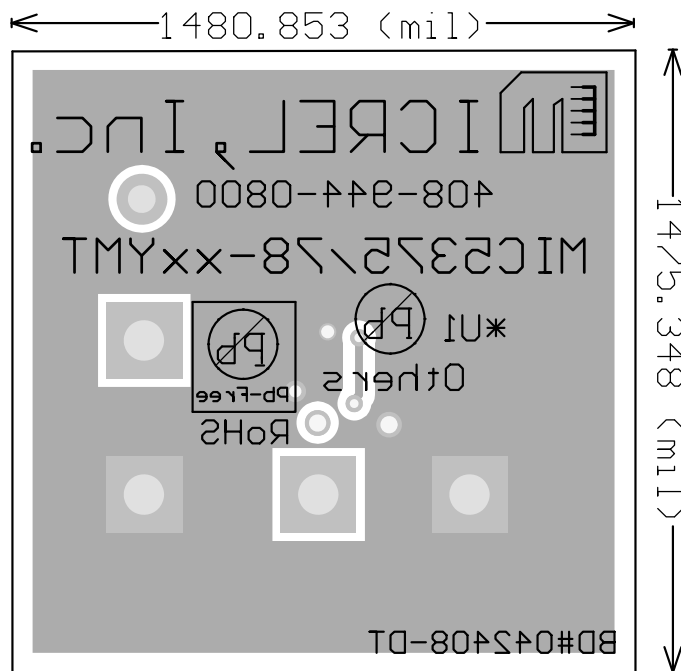

Bottom Layer

### PCB Layout Recommendations (SC-70-5)

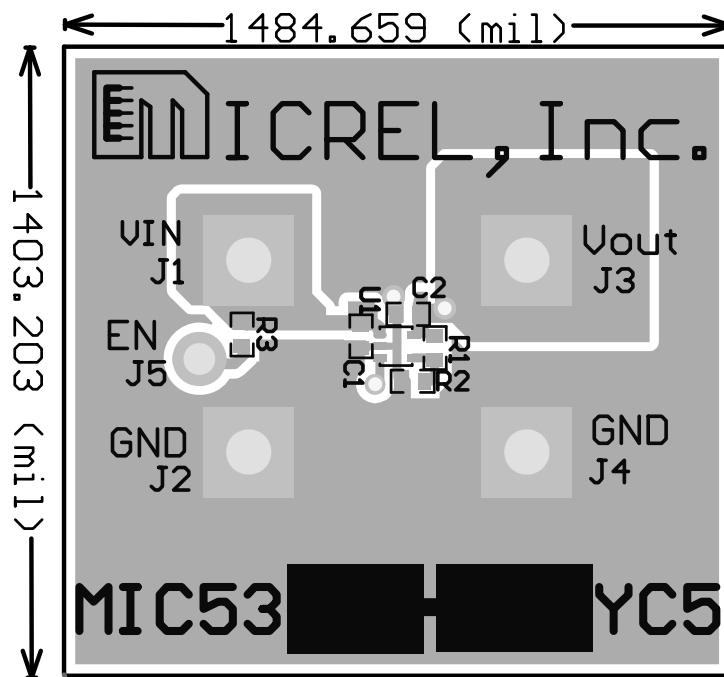

Top Layer

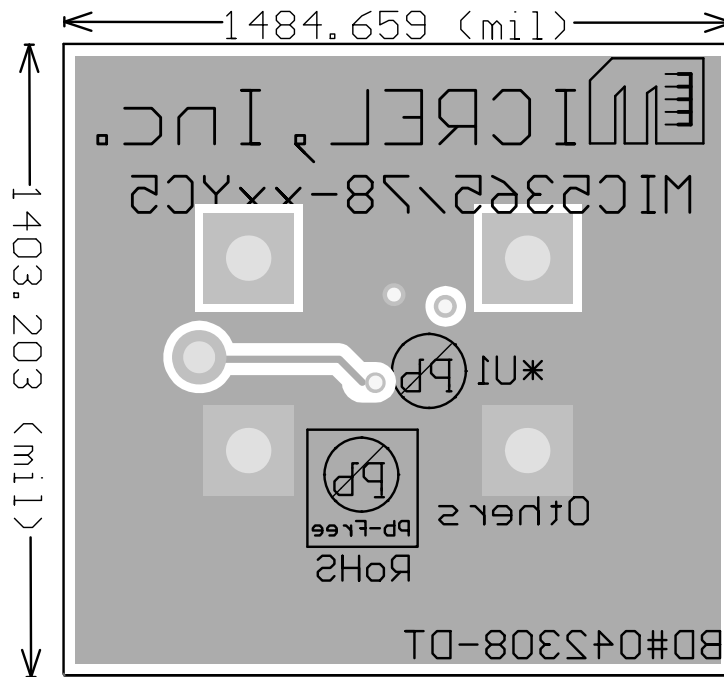

Bottom Layer



# Package Information

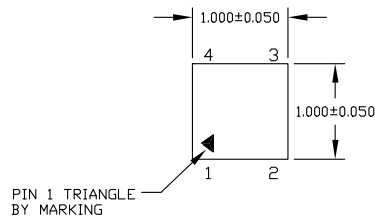

TOP VIEW

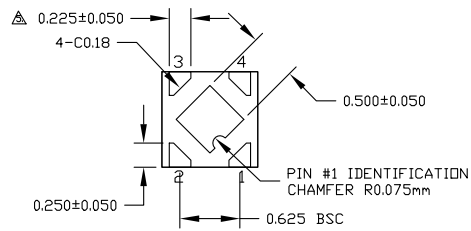

BOTTOM VIEW

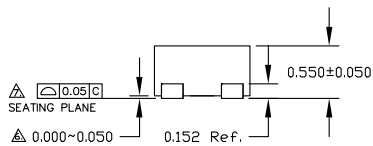

SIDE VIEW

- NOTE:
1. ALL DIMENSIONS ARE IN MILLIMETERS.
  2. MAX. PACKAGE WARPAGE IS 0.05 mm.
  3. MAXIMUM ALLOWABLE BURRS IS 0.076 mm IN ALL DIRECTIONS.
  4. PIN #1 ID ON TOP WILL BE LASER/INK MARKED.
- △ DIMENSION APPLIES TO METALIZED TERMINAL AND IS MEASURED BETWEEN 0.20 AND 0.25 mm FROM TERMINAL TIP.  
 △ APPLIED ONLY FOR TERMINALS.  
 △ APPLIED FOR EXPOSED PAD AND TERMINALS.

## 4-Pin 1mm x 1mm Thin MLF<sup>®</sup> (MT)

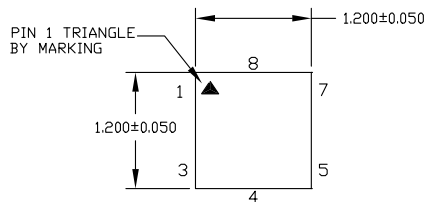

TOP VIEW

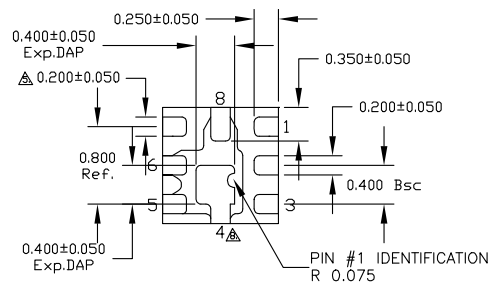

BOTTOM VIEW

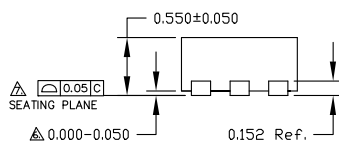

SIDE VIEW

- NOTES :
1. ALL DIMENSIONS ARE IN MILLIMETERS.
  2. MAX. PACKAGE WARPAGE IS 0.05 mm.
  3. MAXIMUM ALLOWABLE BURRS IS 0.076 mm IN ALL DIRECTIONS.
  4. PIN #1 ID ON TOP WILL BE LASER/INK MARKED.
- △ DIMENSION APPLIES TO METALIZED TERMINAL AND IS MEASURED BETWEEN 0.20 AND 0.25 mm FROM TERMINAL TIP.  
 △ APPLIED ONLY FOR TERMINALS.  
 △ APPLIED FOR EXPOSED PAD AND TERMINALS.  
 △ PINS #4,5,6,8 ARE FUSED TO LEADFRAME DIE PAD.

## 8-Pin 1.2mm x 1.2mm Thin MLF<sup>®</sup> (MT)

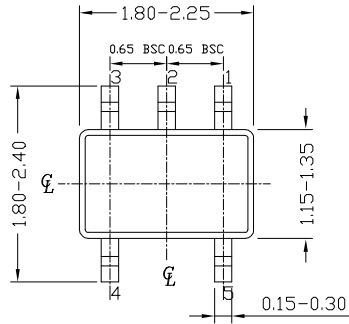

TOP VIEW

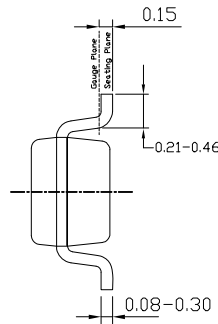

END VIEW

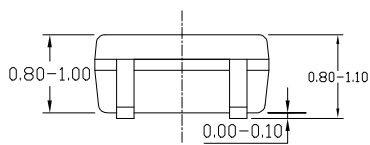

SIDE VIEW

NOTE:

1. ALL DIMENSIONS ARE IN MILLIMETERS.
2. DIMENSIONS ARE INCLUSIVE OF PLATING.
3. DIMENSIONS ARE EXCLUSIVE OF MOLD FLASH & METAL BURR.

**5-Pin SC-70 (C5)**

**MICREL, INC. 2180 FORTUNE DRIVE SAN JOSE, CA 95131 USA**  
 TEL +1 (408) 944-0800 FAX +1 (408) 474-1000 WEB <http://www.micrel.com>

The information furnished by Micrel in this data sheet is believed to be accurate and reliable. However, no responsibility is assumed by Micrel for its use. Micrel reserves the right to change circuitry and specifications at any time without notification to the customer.

Micrel Products are not designed or authorized for use as components in life support appliances, devices or systems where malfunction of a product can reasonably be expected to result in personal injury. Life support devices or systems are devices or systems that (a) are intended for surgical implant into the body or (b) support or sustain life, and whose failure to perform can be reasonably expected to result in a significant injury to the user. A Purchaser's use or sale of Micrel Products for use in life support appliances, devices or systems is a Purchaser's own risk and Purchaser agrees to fully indemnify Micrel for any damages resulting from such use or sale.

© 2008 Micrel, Incorporated.