

# MAC224A Series

Preferred Device

## Triacs

### Silicon Bidirectional Thyristors

Designed primarily for full-wave ac control applications such as lighting systems, heater controls, motor controls and power supplies.

- Blocking Voltage to 800 Volts
- All Diffused and Glass-Passivated Junctions for Parameter Uniformity and Stability
- Gate Triggering Guaranteed in Four Modes
- High Current and Surge Ratings
- Device Marking: Logo, Device Type, e.g., MAC224A4, Date Code

#### MAXIMUM RATINGS ( $T_J = 25^\circ\text{C}$ unless otherwise noted)

Rating	Symbol	Value	Unit
Peak Repetitive Off-State Voltage <sup>(1)</sup> ( $T_J = -40$ to $125^\circ\text{C}$ , Sine Wave 50 to 60 Hz, Gate Open)	$V_{DRM}$ , $V_{RRM}$		Volts
MAC224A4		200	
MAC224A6		400	
MAC224A8		600	
MAC224A10		800	
On-State RMS Current ( $T_C = 75^\circ\text{C}$ ) <sup>(2)</sup> (Full Cycle Sine Wave 50 to 60 Hz)	$I_T(\text{RMS})$	40	A
Peak Non-repetitive Surge Current (One Full Cycle, 60 Hz, $T_J = 125^\circ\text{C}$ )	$I_{TSM}$	350	A
Circuit Fusing Considerations ( $t = 8.3$ ms)	$I^2t$	500	$\text{A}^2\text{s}$
Peak Gate Current (Pulse Width $\leq 2.0$ $\mu\text{sec}$ ; $T_C = 75^\circ\text{C}$ )	$I_{GM}$	$\pm 2.0$	A
Peak Gate Voltage (Pulse Width $\leq 2.0$ $\mu\text{sec}$ ; $T_C = 75^\circ\text{C}$ )	$V_{GM}$	$\pm 10$	Volts
Peak Gate Power (Pulse Width $\leq 2.0$ $\mu\text{sec}$ ; $T_C = 75^\circ\text{C}$ )	$P_{GM}$	20	Watts
Average Gate Power ( $T_C = 75^\circ\text{C}$ , $t = 8.3$ ms)	$P_{G(AV)}$	0.5	Watts
Operating Junction Temperature Range	$T_J$	$-40$ to $125$	$^\circ\text{C}$
Storage Temperature Range	$T_{stg}$	$-40$ to $150$	$^\circ\text{C}$
Mounting Torque	—	8.0	in. lb.

(1)  $V_{DRM}$ ,  $V_{RRM}$  for all types can be applied on a continuous basis. Blocking voltages shall not be tested with a constant current source such that the voltage ratings of the devices are exceeded.

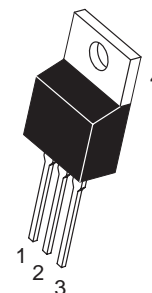
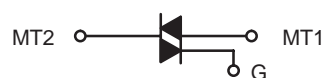
(2) This device is rated for use in applications subject to high surge conditions. Care must be taken to insure proper heat sinking when the device is to be used at high sustained currents. (See Figure 1 for maximum case temperatures.)



**ON Semiconductor**

<http://onsemi.com>

**TRIACS**  
**40 AMPERES RMS**  
**200 thru 800 VOLTS**



**TO-220AB**  
**CASE 221A**  
**STYLE 4**

#### PIN ASSIGNMENT

1	Main Terminal 1
2	Main Terminal 2
3	Gate
4	Main Terminal 2

#### ORDERING INFORMATION

Device	Package	Shipping
MAC224A4	TO220AB	500/Box
MAC224A6	TO220AB	500/Box
MAC224A8	TO220AB	500/Box
MAC224A10	TO220AB	500/Box

Preferred devices are recommended choices for future use and best overall value.

## MAC224A Series

### Thermal Characteristics

Characteristic	Symbol	Value	Unit
Thermal Resistance — Junction to Case — Junction to Ambient	$R_{\theta JC}$ $R_{\theta JA}$	1.0 60	$^{\circ}C/W$
Maximum Lead Temperature for Soldering Purposes 1/8" from Case for 10 Seconds	$T_L$	260	$^{\circ}C$

### Electrical Characteristics ( $T_C = 25^{\circ}C$ unless otherwise noted; Electricals apply in both directions)

Characteristic	Symbol	Min	Typ	Max	Unit
----------------	--------	-----	-----	-----	------

### OFF CHARACTERISTICS

Peak Repetitive Blocking Current (Rated $V_{DRM}$ , $V_{RRM}$ ; Gate Open)	$I_{DRM}$ , $I_{RRM}$	— —	— —	10 2.0	$\mu A$ mA
					$T_J = 25^{\circ}C$ $T_J = 125^{\circ}C$

### ON CHARACTERISTICS

Peak On-State Voltage ( $I_{TM} = \pm 56 A$ Peak, Pulse Width $\leq 2 ms$ , Duty Cycle $\leq 2\%$ )	$V_{TM}$	—	1.4	1.85	Volts
Gate Trigger Current (Continuous dc) ( $V_D = 12 V$ , $R_L = 100 \Omega$ ) MT2(+), G(+); MT2(+), G(-); MT2(+), G(-) MT2(-), G(+)	$I_{GT}$	— —	25 40	50 75	mA
Gate Trigger Voltage (Continuous dc) ( $V_D = 12 V$ , $R_L = 100 \Omega$ ) MT2(+), G(+); MT2(-), G(-); MT(+), G(-) MT2(-), G(+)	$V_{GT}$	— —	1.1 1.3	2.0 2.5	Volts
Gate Non-Trigger Voltage ( $V_D = 12 V$ , $T_J = 125^{\circ}C$ , $R_L = 100 \Omega$ ) All Quadrants	$V_{GD}$	0.2	—	—	Volts
Holding Current ( $V_D = 12 V_{dc}$ , Gate Open, Initiating Current = $\pm 200 mA$ )	$I_H$	—	30	75	mA
Gate Controlled Turn-On Time ( $V_D = \text{Rated } V_{DRM}$ , $I_{TM} = 56 A$ Peak, $I_G = 200 mA$ )	$t_{gt}$	—	1.5	—	$\mu s$

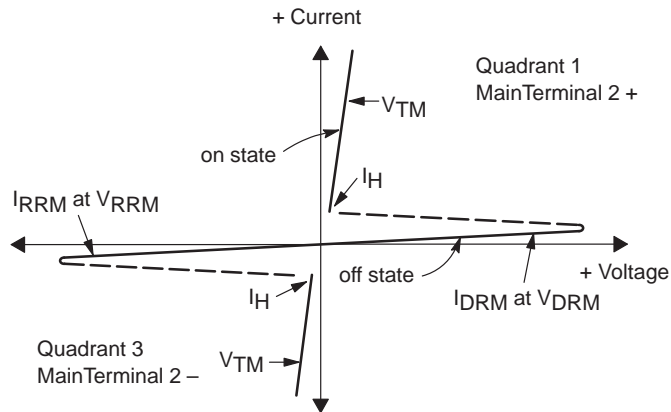
### DYNAMIC CHARACTERISTICS

Critical Rate of Rise of Off-State Voltage ( $V_D = \text{Rated } V_{DRM}$ , Exponential Waveform, $T_C = 125^{\circ}C$ )	$dv/dt$	—	50	—	$V/\mu s$
Critical Rate of Rise of Commutation Voltage ( $V_D = \text{Rated } V_{DRM}$ , $I_{TM} = 56 A$ Peak, Commutating $di/dt = 20.2 A/ms$ , Gate Unenergized, $T_C = 75^{\circ}C$ )	$dv/dt(c)$	—	5.0	—	$V/\mu s$

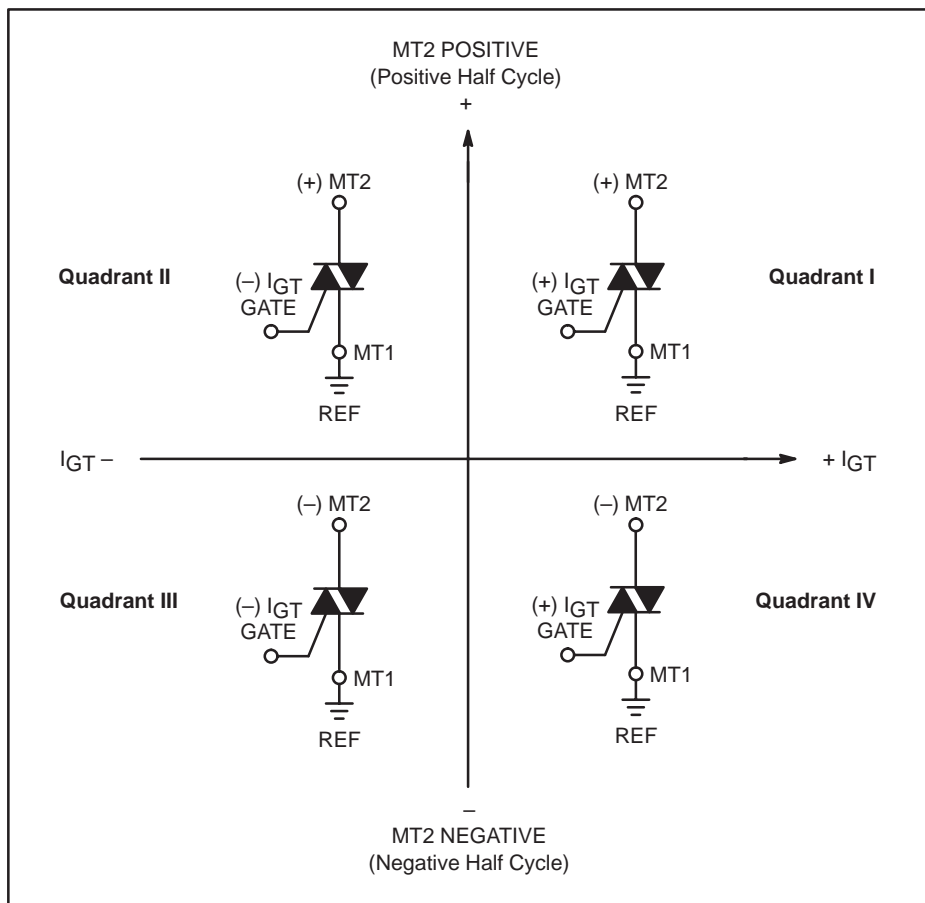
# MAC224A Series

## Voltage Current Characteristic of Triacs (Bidirectional Device)

Symbol	Parameter
$V_{DRM}$	Peak Repetitive Forward Off State Voltage
$I_{DRM}$	Peak Forward Blocking Current
$V_{RRM}$	Peak Repetitive Reverse Off State Voltage
$I_{RRM}$	Peak Reverse Blocking Current
$V_{TM}$	Maximum On State Voltage
$I_H$	Holding Current

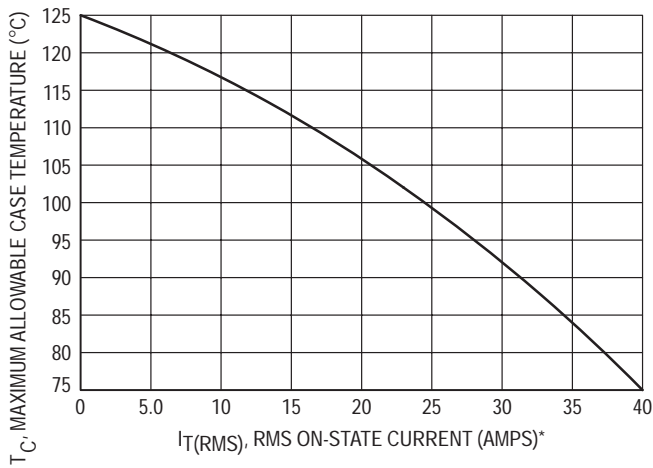


### Quadrant Definitions for a Triac

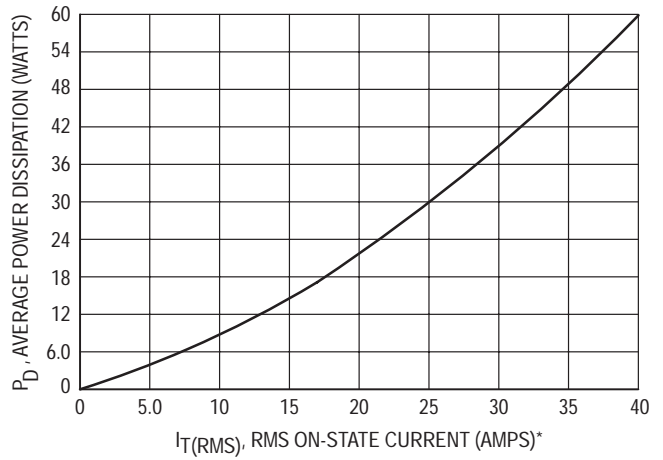


All polarities are referenced to MT1.  
 With in-phase signals (using standard AC lines) quadrants I and III are used.

## MAC224A Series

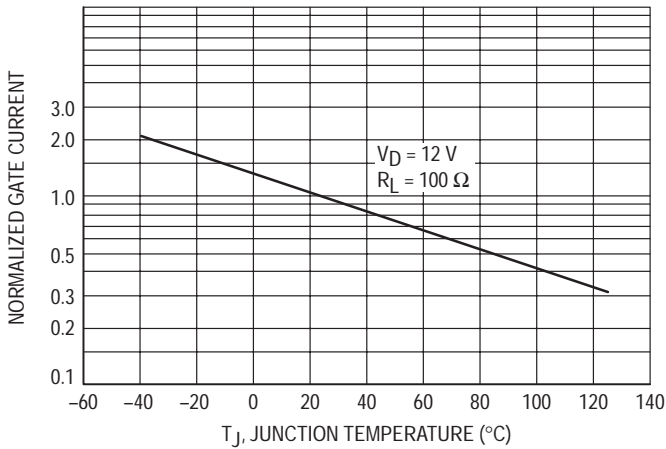


**Figure 1. RMS Current Derating**

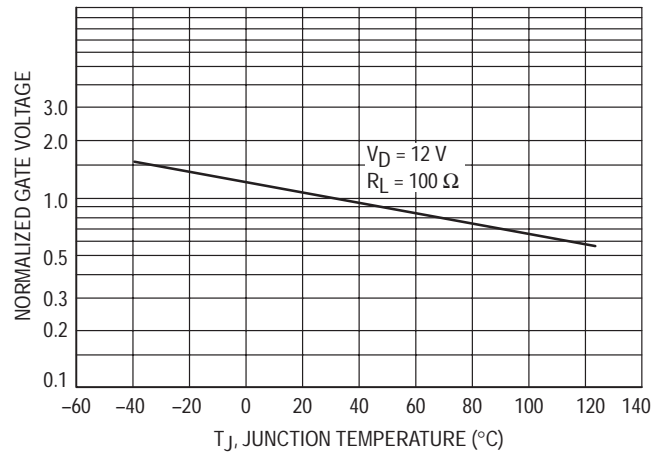


**Figure 2. On-State Power Dissipation**

\*This device is rated for use in applications subject to high surge conditions. Care must be taken to insure proper heat sinking when the device is to be used at high sustained currents.



**Figure 3. Typical Gate Trigger Current**



**Figure 4. Typical Gate Trigger Voltage**

# MAC224A Series

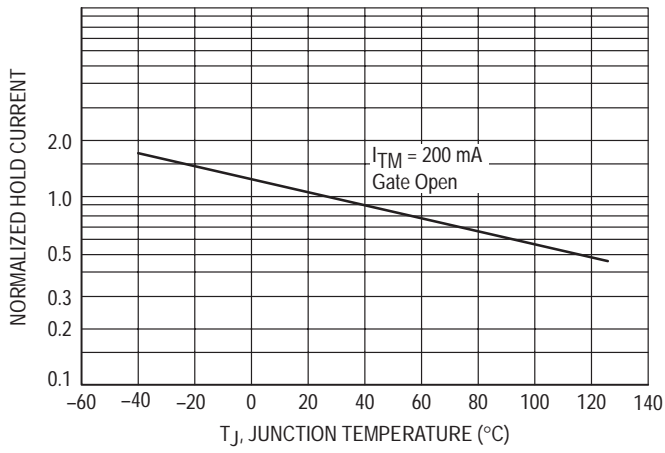


Figure 5. Typical Holding Current

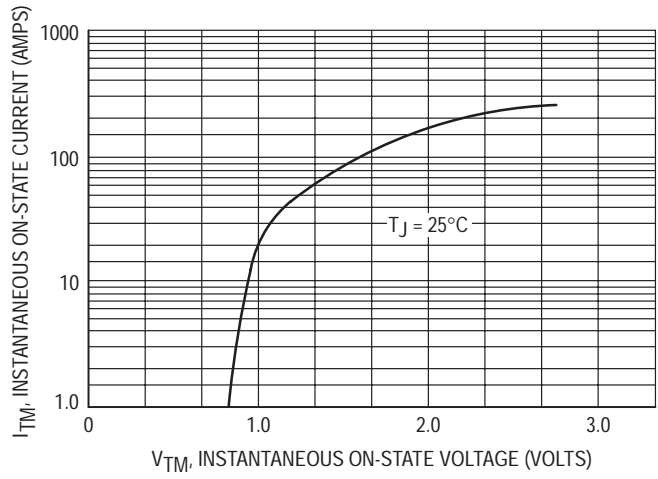


Figure 6. Typical On-State Characteristics

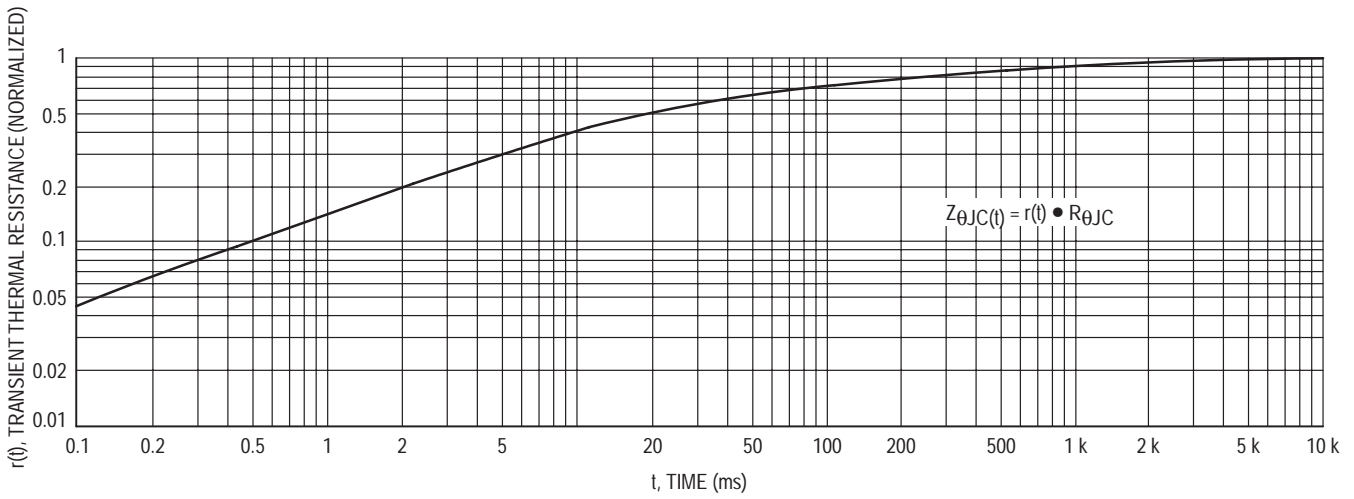
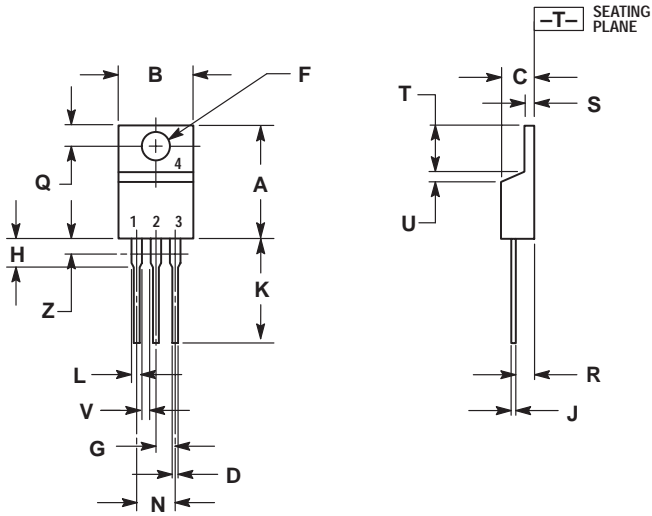


Figure 7. Thermal Response

# MAC224A Series

## PACKAGE DIMENSIONS

TO-220AB  
CASE 221A-07  
ISSUE Z



- NOTES:
1. DIMENSIONING AND TOLERANCING PER ANSI Y14.5M, 1982.
  2. CONTROLLING DIMENSION: INCH.
  3. DIMENSION Z DEFINES A ZONE WHERE ALL BODY AND LEAD IRREGULARITIES ARE ALLOWED.

DIM	INCHES		MILLIMETERS	
	MIN	MAX	MIN	MAX
A	0.570	0.620	14.48	15.75
B	0.380	0.405	9.66	10.28
C	0.160	0.190	4.07	4.82
D	0.025	0.035	0.64	0.88
F	0.142	0.147	3.61	3.73
G	0.095	0.105	2.42	2.66
H	0.110	0.155	2.80	3.93
J	0.014	0.022	0.36	0.55
K	0.500	0.562	12.70	14.27
L	0.045	0.060	1.15	1.52
N	0.190	0.210	4.83	5.33
O	0.100	0.120	2.54	3.04
R	0.080	0.110	2.04	2.79
S	0.045	0.055	1.15	1.39
T	0.235	0.255	5.97	6.47
U	0.000	0.050	0.00	1.27
V	0.045	---	1.15	---
Z	---	0.080	---	2.04

- STYLE 4:
- PIN 1. MAIN TERMINAL 1
  - MAIN TERMINAL 2
  - GATE
  - MAIN TERMINAL 2

# Notes

# MAC224A Series

**ON Semiconductor** and  are trademarks of Semiconductor Components Industries, LLC (SCILLC). SCILLC reserves the right to make changes without further notice to any products herein. SCILLC makes no warranty, representation or guarantee regarding the suitability of its products for any particular purpose, nor does SCILLC assume any liability arising out of the application or use of any product or circuit, and specifically disclaims any and all liability, including without limitation special, consequential or incidental damages. "Typical" parameters which may be provided in SCILLC data sheets and/or specifications can and do vary in different applications and actual performance may vary over time. All operating parameters, including "Typicals" must be validated for each customer application by customer's technical experts. SCILLC does not convey any license under its patent rights nor the rights of others. SCILLC products are not designed, intended, or authorized for use as components in systems intended for surgical implant into the body, or other applications intended to support or sustain life, or for any other application in which the failure of the SCILLC product could create a situation where personal injury or death may occur. Should Buyer purchase or use SCILLC products for any such unintended or unauthorized application, Buyer shall indemnify and hold SCILLC and its officers, employees, subsidiaries, affiliates, and distributors harmless against all claims, costs, damages, and expenses, and reasonable attorney fees arising out of, directly or indirectly, any claim of personal injury or death associated with such unintended or unauthorized use, even if such claim alleges that SCILLC was negligent regarding the design or manufacture of the part. SCILLC is an Equal Opportunity/Affirmative Action Employer.

## PUBLICATION ORDERING INFORMATION

### NORTH AMERICA Literature Fulfillment:

Literature Distribution Center for ON Semiconductor  
P.O. Box 5163, Denver, Colorado 80217 USA  
**Phone:** 303-675-2175 or 800-344-3860 Toll Free USA/Canada  
**Fax:** 303-675-2176 or 800-344-3867 Toll Free USA/Canada  
**Email:** ONlit@hibbertco.com  
Fax Response Line: 303-675-2167 or 800-344-3810 Toll Free USA/Canada

**N. American Technical Support:** 800-282-9855 Toll Free USA/Canada

**EUROPE:** LDC for ON Semiconductor – European Support

**German Phone:** (+1) 303-308-7140 (M-F 1:00pm to 5:00pm Munich Time)  
**Email:** ONlit-german@hibbertco.com  
**French Phone:** (+1) 303-308-7141 (M-F 1:00pm to 5:00pm Toulouse Time)  
**Email:** ONlit-french@hibbertco.com  
**English Phone:** (+1) 303-308-7142 (M-F 12:00pm to 5:00pm UK Time)  
**Email:** ONlit@hibbertco.com

**EUROPEAN TOLL-FREE ACCESS\*: 00-800-4422-3781**

\*Available from Germany, France, Italy, England, Ireland

### CENTRAL/SOUTH AMERICA:

**Spanish Phone:** 303-308-7143 (Mon-Fri 8:00am to 5:00pm MST)  
**Email:** ONlit-spanish@hibbertco.com

**ASIA/PACIFIC:** LDC for ON Semiconductor – Asia Support

**Phone:** 303-675-2121 (Tue-Fri 9:00am to 1:00pm, Hong Kong Time)  
Toll Free from Hong Kong & Singapore:  
**001-800-4422-3781**  
**Email:** ONlit-asia@hibbertco.com

**JAPAN:** ON Semiconductor, Japan Customer Focus Center  
4-32-1 Nishi-Gotanda, Shinagawa-ku, Tokyo, Japan 141-8549  
**Phone:** 81-3-5740-2745  
**Email:** r14525@onsemi.com

**ON Semiconductor Website:** <http://onsemi.com>

For additional information, please contact your local Sales Representative.

MAC224A/D