

XC62FP Series

Positive Voltage Regulators



- ◆ CMOS Low Power Consumption
- ◆ Small Input-Output Voltage Differential
 - : 0.12V @ 100mA,
 - 0.38V @ 200mA
- ◆ Maximum Output Current : 250mA (V_{OUT}=5.0V)
- ◆ Output Voltage Range : 2.0V~6.0V
- ◆ Highly Accurate : ±2% (±1%)

Applications

- Battery Powered Equipment
- Palmtops
- Portable Cameras and Video Recorders
- Reference Voltage Sources

3

General Description

The XC62FP series is a group of positive voltage output, three-pin regulators, that provide a high current even when the input/output voltage differential is small. Low power consumption and high accuracy is achieved through CMOS and laser trimming technologies.

The XC62FP consists of a high-precision voltage reference, an error amplification circuit, and a current limited output driver. Transient response to load variations have improved in comparison to the existing series.

SOT-23 (150mW), SOT-89 (500mW) and TO-92 (300mW) packages are available.

Features

- Maximum Output Current**
 - : 250mA
 - (within max. power dissipation, V_{OUT} = 5.0V)
- Output Voltage Range**
 - : 2.0V ~ 6.0V in 0.1V increments
 - (1.5V ~ 1.9V for custom products)
- Highly Accurate**: Output voltage ±2%
(±1% for semi-custom products)
- Low Power Consumption**
 - : Typ. 2.0µA @ V_{OUT}=5.0V
- Output Voltage Temperature Characteristics**
 - : Typ. ±100ppm/°C
- Input Stability** : Typ. 0.2%/V
- Small Input-Output Differential**
 - : I_{OUT} = 100mA @ V_{OUT} = 5.0V with a 0.12V differential.
- Ultra Small Packages**
 - : SOT-23 (150mW) mini-mold,
 - SOT-89 (500mW) mini-power mold
 - TO-92 (300mW)

Typical Application Circuit

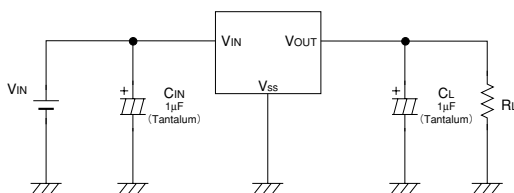

Typical Performance Characteristic

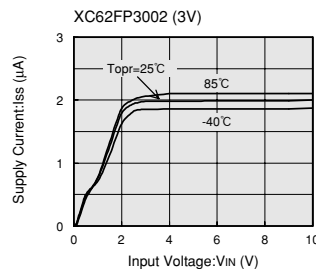

XC62FP Series

Pin Configuration

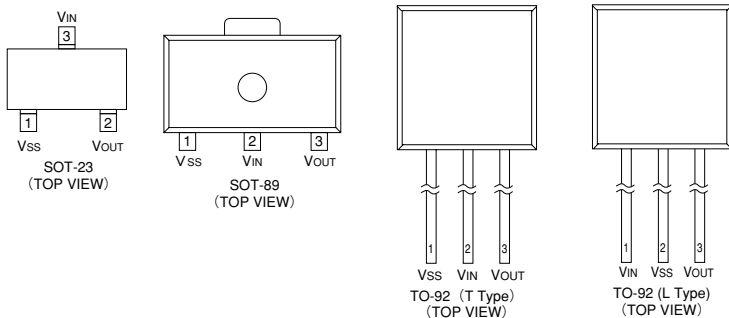

3

Pin Assignment

PIN NUMBER				PIN NAME	FUNCTION
SOT-23	SOT-89	TO-92 (T)	TO-92 (L)		
1	1	1	2	VSS	Ground
3	2	2	1	VIN	Supply voltage input
2	3	3	3	VOUT	Regulated voltage output

Product Classification

Ordering Information

XC62FXXXXXX
 ↑ ↑ ↑ ↑ ↑ ↑
 a b c d e f

DESIGNATOR	DESCRIPTION	DESIGNATOR	DESCRIPTION
a	Polarity of Output Voltage: P: + (Positive)	e	Package Type M=SOT-23 P=SOT-89 T=TO-92 (Standard) L=TO-92 (Custom pin configuration)
b	Output Voltage 30=3.0V 50=5.0V		
c	Temperature Coefficients: 0=±100ppm (typical)	f	Device Orientation R=Embossed Tape (Standard Feed) L=Embossed Tape (Reverse Feed) H=Paper Tape (TO-92) B=Bag (TO-92)
d	Output Voltage Accuracy: 1=±1.0% (Semi-custom) 2=±2.0%		

■ Packaging Information

● SOT-23

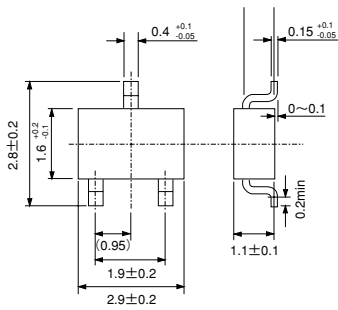

3

● SOT-89

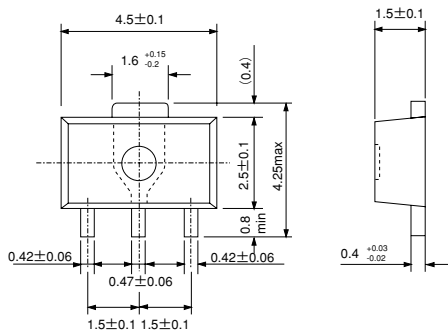

XC62FP Series

●TO-92

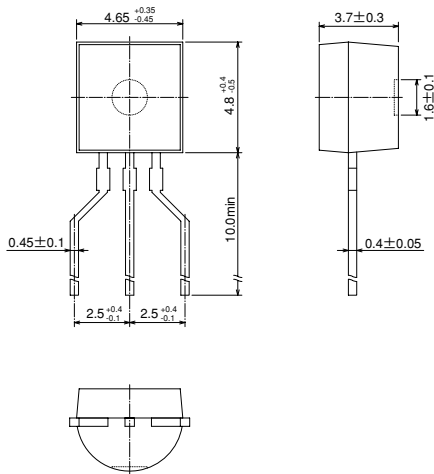

3

■Marking

●SOT-23, SOT-89

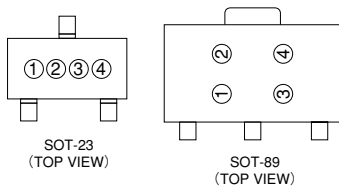

① Represents the integer of the Output Voltage

SYMBOL	VOLTAGE(V)	SYMBOL	VOLTAGE(V)
1	1.②	5	5.②
2	2.②	6	6.②
3	3.②		
4	4.②		

② Represents the decimal number of the Output Voltage

SYMBOL	VOLTAGE(V)	SYMBOL	VOLTAGE(V)
A	①.0	F	①.5
B	①.1	H	①.6
C	①.2	K	①.7
D	①.3	L	①.8
E	①.4	M	①.9

③ Based on internal standards

SYMBOL
0

④ Represents the assembly lot no.
Based on internal standards

●TO-92

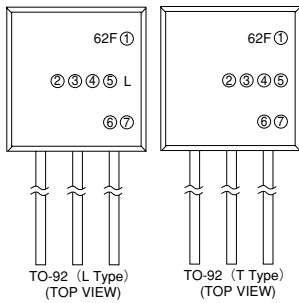

① Represents the polarity of Output Voltage

DESIGNATOR	CONFIGURATION
P	CMOS

④ Represents the temperature characteristics

DESIGNATOR	TEMPERATURE CHARACTERISTICS
0	TPY±100ppm

⑥ Represents a least significant digit of the produced year

DESIGNATOR	PRODUCED YEAR
0	2000
1	2001

⑦ Denotes the production lot number
0 to 9, A to Z repeated (G,I,J,O,Q,W excepted)

②③ Represents the Detect Voltage

DESIGNATOR		VOLTAGE (V)
②	③	
3	3	3.3
5	0	5.0

⑤ Represents the Detect Voltage Accuracy

DESIGNATOR	DETECT VOLTAGE ACCURACY
1	within ±1% (semi-custom)
2	within ±2%

3

■Block Diagram

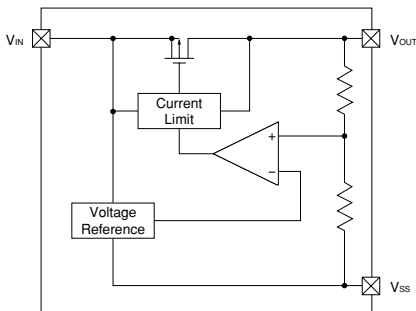

■Absolute Maximum Ratings

Ta=25°C

PARAMETER	SYMBOL	RATINGS	UNITS
Input Voltage	V _{IN}	12	V
Output Current	I _{OUT}	500	mA
Output Voltage	V _{OUT}	V _{SS} +0.3 ~ V _{IN} +0.3	V
Continuous Total Power Dissipation	SOT-23	P _d	150
	SOT-89		500
	TO-92		300
Operating Ambient Temperature	T _{opr}	-40 ~ +85	°C
Storage Temperature	T _{stg}	-40 ~ +125	°C

XC62FP Series

Electrical Characteristics

XC62FP5002 $V_{OUT}(T)=5.0V$ (Note1)

$T_a=25^\circ C$

PARAMETER	SYMBOL	CONDITIONS	MIN	TYP	MAX	UNITS	CIRCUIT
Output Voltage	$V_{OUT}(E)$ (Note2)	$I_{OUT}=40mA$ $V_{IN}=6.0V$	4.900	5.000	5.100	V	1
Maximum Output Current	$I_{OUT\ max}$	$V_{IN}=6.0V, V_{OUT}(E) \geq 4.5V$	250			mA	1
Load Stability	ΔV_{OUT}	$V_{IN}=6.0V$ $1mA \leq I_{OUT} \leq 100mA$		40	80	mV	1
Input -Output Voltage Differential (Note3)	V_{dif1}	$I_{OUT}=100mA$		120	300	mV	1
	V_{dif2}	$I_{OUT}=200mA$		380	600	mV	1
Supply Current	I_{SS}	$V_{IN}=6.0V$		2.0	4.5	μA	2
Input Stability	$\frac{\Delta V_{OUT}}{\Delta V_{IN} \cdot V_{OUT}}$	$I_{OUT}=40mA$ $6.0V \leq V_{IN} \leq 10.0V$		0.2	0.3	%/V	1
Input Voltage	V_{IN}				10	V	—
Output Voltage Temperature Characteristics	$\frac{\Delta V_{OUT}}{\Delta T_{opr} \cdot V_{OUT}}$	$I_{OUT}=40mA$ $-40^\circ C \leq T_{opr} \leq 85^\circ C$		± 100		ppm/ $^\circ C$	1

XC62FP4002 $V_{OUT}(T)=4.0V$ (Note1)

$T_a=25^\circ C$

PARAMETER	SYMBOL	CONDITIONS	MIN	TYP	MAX	UNITS	CIRCUIT
Output Voltage	$V_{OUT}(E)$ (Note2)	$I_{OUT}=40mA$ $V_{IN}=5.0V$	3.920	4.000	4.080	V	1
Maximum Output Current	$I_{OUT\ max}$	$V_{IN}=5.0V, V_{OUT}(E) \geq 3.6V$	200			mA	1
Load Stability	ΔV_{OUT}	$V_{IN}=5.0V$ $1mA \leq I_{OUT} \leq 100mA$		45	90	mV	1
Input -Output Voltage Differential (Note3)	V_{dif1}	$I_{OUT}=100mA$		170	330	mV	1
	V_{dif2}	$I_{OUT}=200mA$		400	630	mV	1
Supply Current	I_{SS}	$V_{IN}=5.0V$		2.0	4.5	μA	2
Input Stability	$\frac{\Delta V_{OUT}}{\Delta V_{IN} \cdot V_{OUT}}$	$I_{OUT}=40mA$ $5.0V \leq V_{IN} \leq 10.0V$		0.2	0.3	%/V	1
Input Voltage	V_{IN}				10	V	—
Output Voltage Temperature Characteristics	$\frac{\Delta V_{OUT}}{\Delta T_{opr} \cdot V_{OUT}}$	$I_{OUT}=40mA$ $-40^\circ C \leq T_{opr} \leq 85^\circ C$		± 100		ppm/ $^\circ C$	1

3

XC62FP
Series

XC62FP3002 $V_{OUT}(T)=3.0V$ (Note1)

$T_a=25^\circ C$

PARAMETER	SYMBOL	CONDITIONS	MIN	TYP	MAX	UNITS	CIRCUIT
Output Voltage	$V_{OUT}(E)$ (Note2)	$I_{OUT}=40mA$ $V_{IN}=4.0V$	2.940	3.000	3.060	V	1
Maximum Output Current	$I_{OUT\ max}$	$V_{IN}=4.0V, V_{OUT}(E) \geq 2.7V$	150			mA	1
Load Stability	ΔV_{OUT}	$V_{IN}=4.0V$ $1mA \leq I_{OUT} \leq 80mA$		45	90	mV	1
Input -Output Voltage Differential (Note3)	Vdif1	$I_{OUT}=80mA$		180	360	mV	1
	Vdif2	$I_{OUT}=160mA$		400	700	mV	1
Supply Current	I_{SS}	$V_{IN}=4.0V$		2.0	4.5	μA	2
Input Stability	$\frac{\Delta V_{OUT}}{\Delta V_{IN} \cdot V_{OUT}}$	$I_{OUT}=40mA$ $4.0V \leq V_{IN} \leq 10.0V$		0.2	0.3	%/V	1
Input Voltage	V_{IN}				10	V	—
Output Voltage Temperature Characteristics	$\frac{\Delta V_{OUT}}{\Delta T_{opr} \cdot V_{OUT}}$	$I_{OUT}=40mA$ $-40^\circ C \leq T_{opr} \leq 85^\circ C$		± 100		ppm/ $^\circ C$	1

3

XC62FP2002 $V_{OUT}(T)=2.0V$ (Note1)

$T_a=25^\circ C$

PARAMETER	SYMBOL	CONDITIONS	MIN	TYP	MAX	UNITS	CIRCUIT
Output Voltage	$V_{OUT}(E)$ (Note2)	$I_{OUT}=40mA$ $V_{IN}=3.0V$	1.960	2.000	2.040	V	1
Maximum Output Current	$I_{OUT\ max}$	$V_{IN}=3.0V, V_{OUT}(E) \geq 1.8V$	100			mA	1
Load Stability	ΔV_{OUT}	$V_{IN}=3.0V$ $1mA \leq I_{OUT} \leq 60mA$		45	90	mV	1
Input -Output Voltage Differential (Note3)	Vdif1	$I_{OUT}=60mA$		180	360	mV	1
	Vdif2	$I_{OUT}=120mA$		400	700	mV	1
Supply Current	I_{SS}	$V_{IN}=3.0V$		2.0	4.5	μA	2
Input Stability	$\frac{\Delta V_{OUT}}{\Delta V_{IN} \cdot V_{OUT}}$	$I_{OUT}=40mA$ $3.0V \leq V_{IN} \leq 10.0V$		0.2	0.3	%/V	1
Input Voltage	V_{IN}				10	V	—
Output Voltage Temperature Characteristics	$\frac{\Delta V_{OUT}}{\Delta T_{opr} \cdot V_{OUT}}$	$I_{OUT}=40mA$ $-40^\circ C \leq T_{opr} \leq 85^\circ C$		± 100		ppm/ $^\circ C$	1

- Note:
1. $V_{OUT}(T)$ =Specified Output Voltage .
 2. $V_{OUT}(E)$ =Effective Output Voltage (i.e. the output voltage when " $V_{OUT}(T)+1.0V$ " is provided at the V_{IN} pin while maintaining a certain I_{OUT} value).
 3. $V_{dif} = (V_{IN1} - V_{OUT}(E))$.
 4. V_{IN1} = The input voltage at the time 98% of $V_{OUT}(E)$ is output (input voltage has been gradually reduced).

XC62FP Series

■ Typical Application Circuit

● Standard Circuit

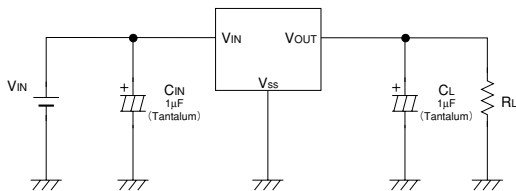

3

■ Directions for use

● Notes on Use

1. Please use this IC within the stipulated absolute maximum ratings as the IC is liable to malfunction outside of such parameters.
2. There is a possibility that oscillation may occur as a result of the impedance present between the power supply and the IC's input. Where impedance is 10Ω or more, please use a capacitor (C_{IN}) of at least $1\mu F$.
With a large output current, operations can be stabilised by increasing capacitor size (C_{IN}). If C_{IN} is small and capacitor size (C_L) is increased, there is a possibility of oscillation due to input impedance.
In such cases, operations can be stabilised by either increasing the size of C_{IN} or decreasing the size of C_L .
3. Please ensure that output current (I_{OUT}) is less than $P_d \div (V_{IN} - V_{OUT})$ and does not exceed the stipulated Continuous Total Power Dissipation value (P_d) for the package.
4. Should you wish to increase output current (I_{OUT}) and/or have the capability to exceed the stipulated P_d value, using a current boost circuit (similar to the one shown below) is likely to lead to oscillation.
With such applications, we recommend use of a boost type voltage regulator, such as the Torex XC62EP series.

Current Boost Circuit : Poor Example

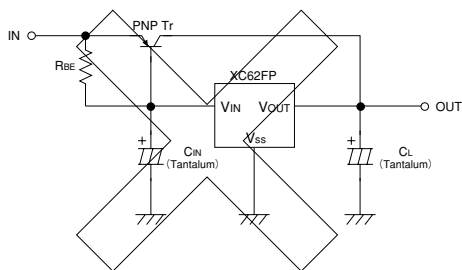

Test Circuits

Circuit 1

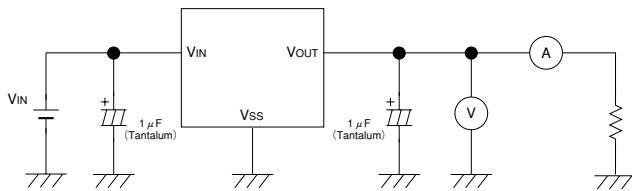

3

Circuit 2

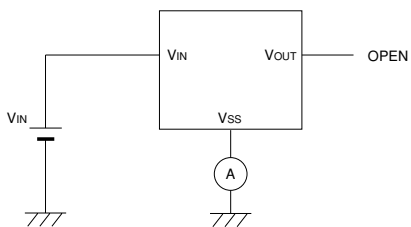

XC62FP Series

Typical Performance Characteristics

(1) OUTPUT VOLTAGE vs. OUTPUT CURRENT

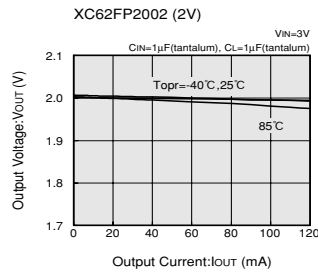
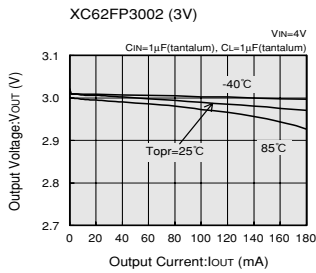
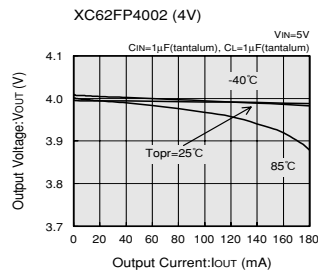
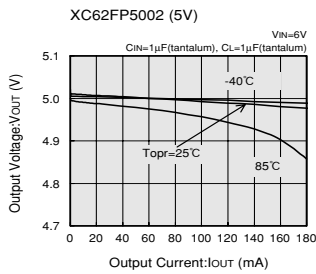

(2) OUTPUT VOLTAGE vs. INPUT VOLTAGE

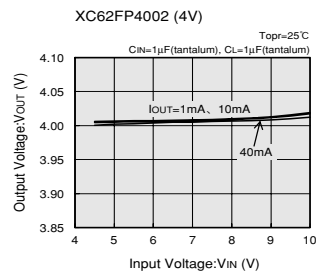
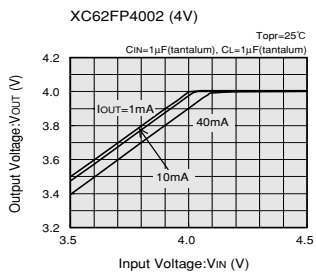
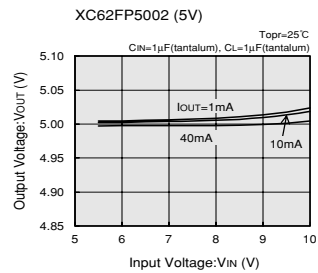
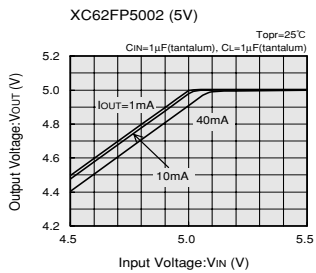

(2) OUTPUT VOLTAGE vs. INPUT VOLTAGE

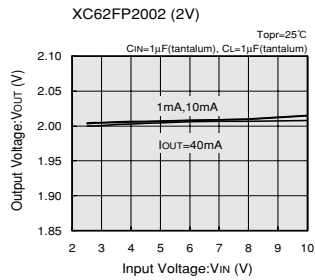
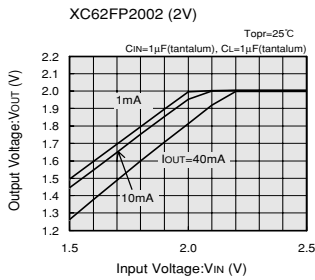
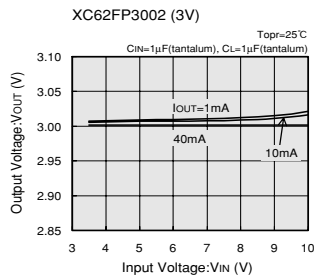
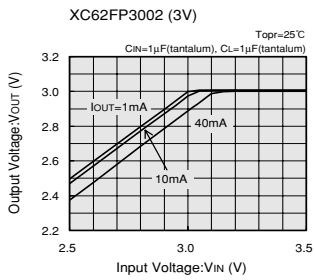

3

(3) INPUT/OUTPUT VOLTAGE DIFFERENTIAL vs. OUTPUT CURRENT

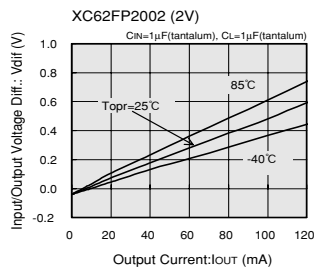
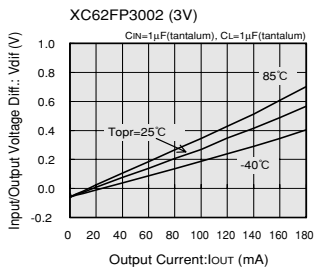
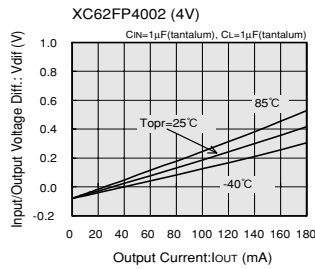
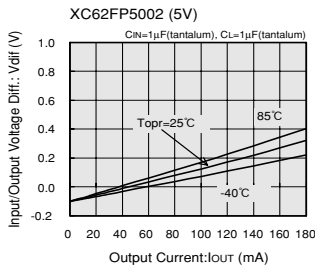

XC62FP Series

(4) SUPPLY CURRENT vs. INPUT VOLTAGE

3

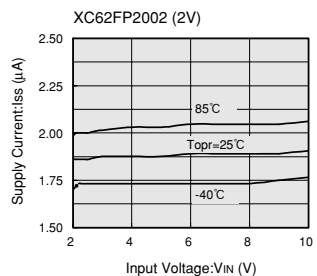
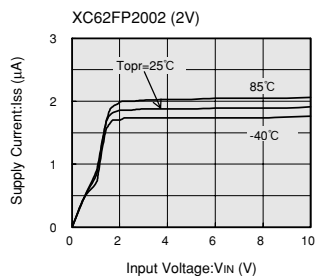
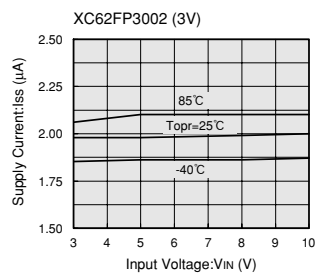
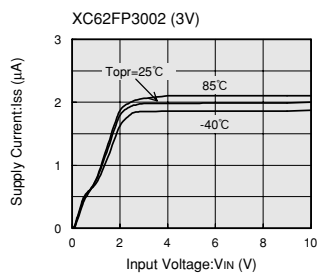
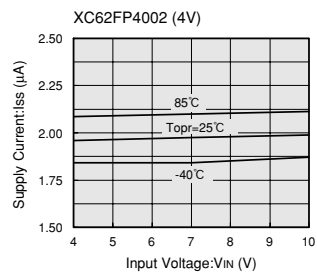
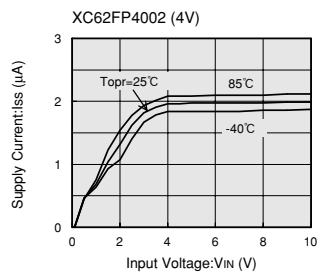
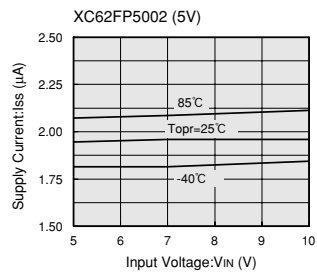
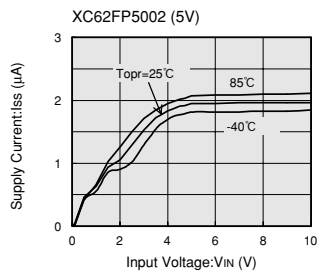

(5) OUTPUT VOLTAGE vs. AMBIENT TEMPERATURE

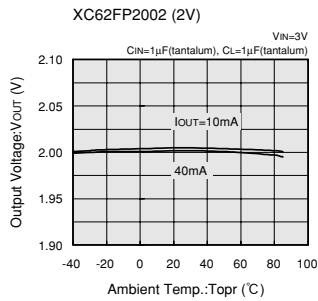
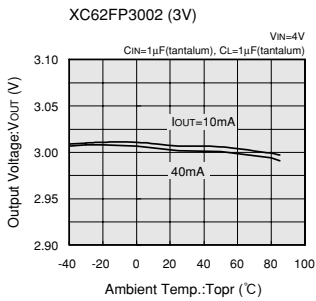
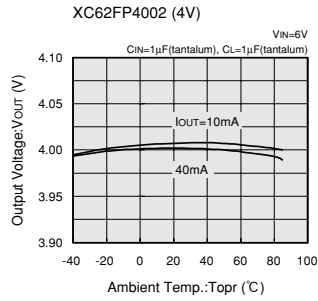
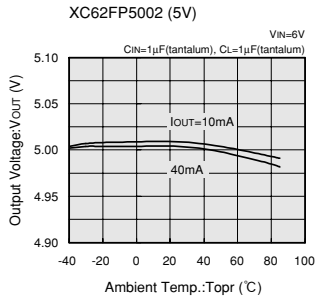

3

(6) SUPPLY CURRENT vs. AMBIENT TEMPERATURE

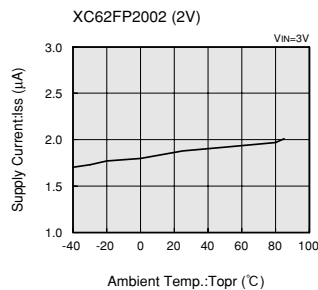
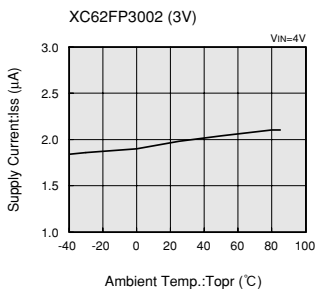
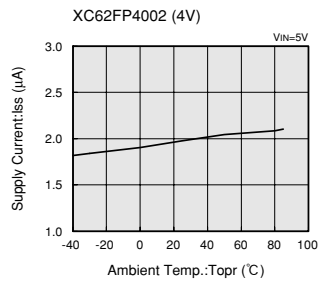
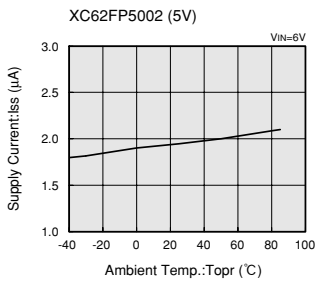

XC62FP Series

(7) INPUT TRANSIENT RESPONSE 1

3

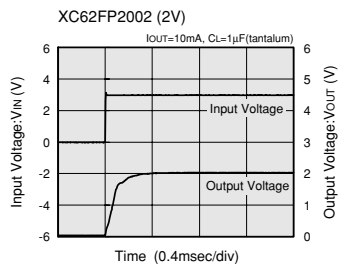
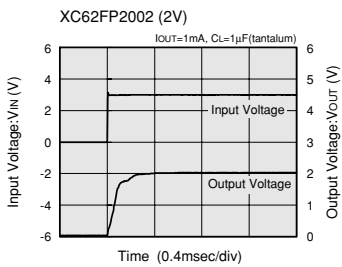
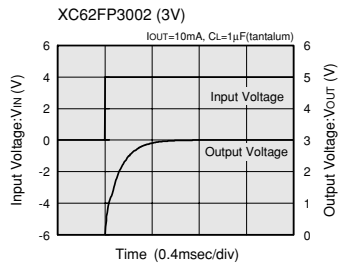
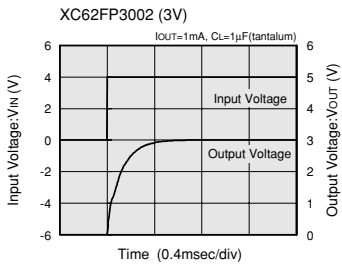
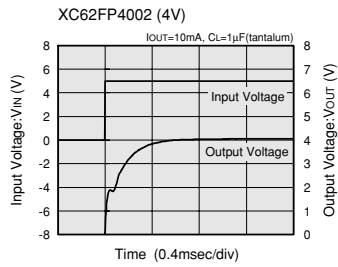
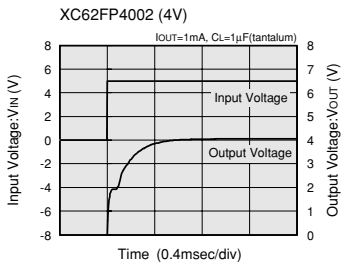
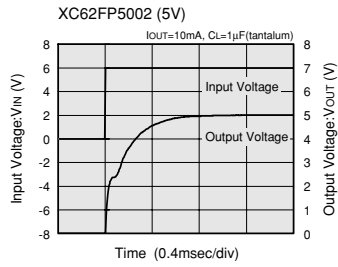
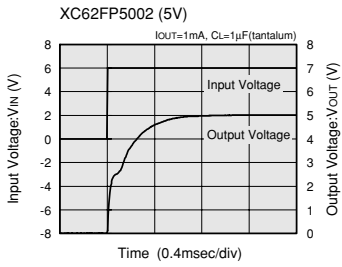

(8) INPUT TRANSIENT RESPONSE 2

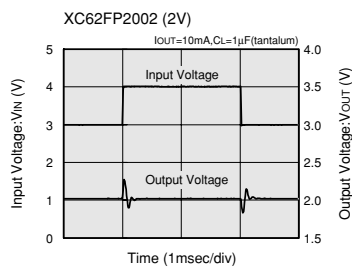
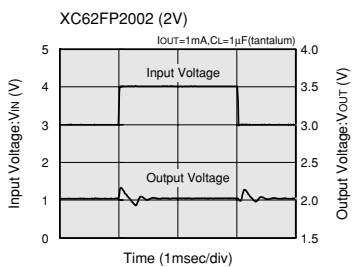
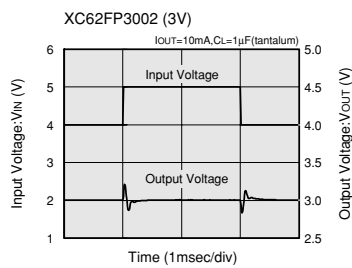
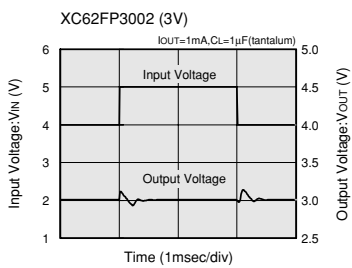
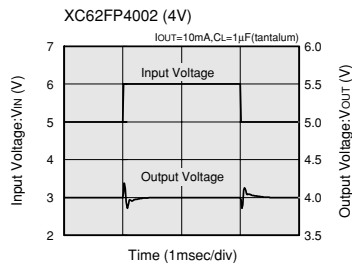
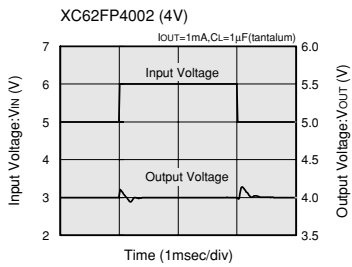
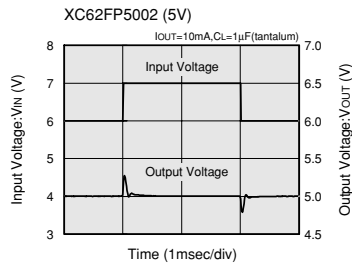
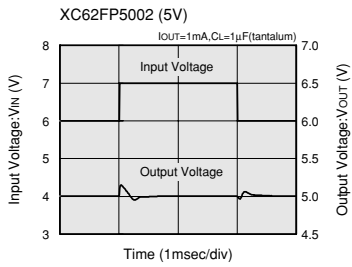

XC62FP Series

(9) LOAD TRANSIENT RESPONSE

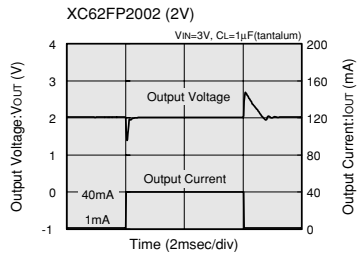
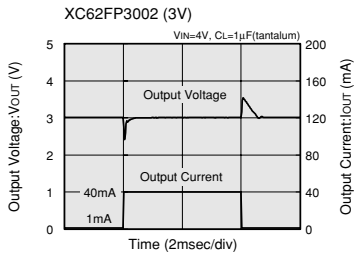
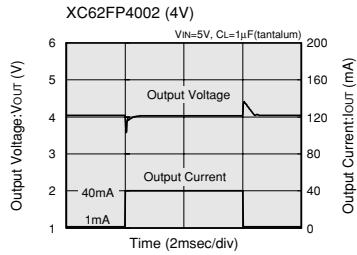
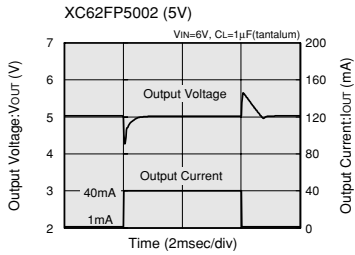

(10) RIPPLE REJECTION RATE

