

XC6204 Series



(Can be used with low ESR Capacitor Compatible. ON-OFF Switch) High Speed LDO Regulators

- ◆ CMOS Low Power Consumption
- ◆ Dropout Voltage : 60mV @ 30mA,
200mV @ 100mA
- ◆ Maximum Output Current : 150mA
- ◆ Highly Accurate : ± 2%
- ◆ Output Voltage Range : 1.8V ~ 6.0V
- ◆ Low ESR capacitor compatible

Applications

- Mobile phones
- Cordless phones
- Cameras, video recorders
- Portable games
- Portable AV equipment
- Reference voltage
- Battery powered equipment

3

General Description

The XC6204 series are highly precise, low noise, positive voltage LDO regulators manufactured using CMOS processes. The series achieves high ripple rejection and low dropout and consists of a standard voltage source, an error correction, current limiter and a phase compensation circuit plus a driver transistor.

Output voltage is selectable in 50mV increments within a range of 1.8V ~ 6.0V.

The series is also compatible with low ESR ceramic capacitors which give added output stability. This stability can be maintained even during load fluctuations due to the excellent transient response of the series.

The current limiter's foldback circuit also operates as a short protect for the output current limiter and the output pin.

The CE function enables the output to be turned off, resulting in greatly reduced power consumption.

Features

- Maximum Output Current : 150mA
- Dropout Voltage : 200mV ($I_{OUT} = 100mA$)
- Maximum Operating Voltage : 10V
- Output Voltage Range : 1.8V ~ 6.0V in 50mV increments
- Highly Accurate : ± 2%
- Low Power Consumption : TYP 70μA
- Standby Current : less than 0.1μA
- High Ripple Rejection : 70dB (10 kHz)
- Low Output Noise : 30μVrms
- Operational Temperature Range : -40°C ~ +85°C
- Low ESR Capacitor Compatible : Ceramic capacitor

Typical Application Circuit

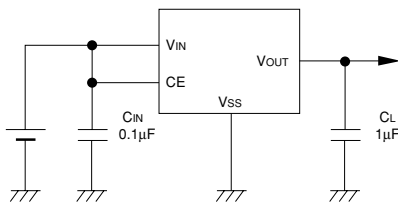

Typical Performance Characteristic

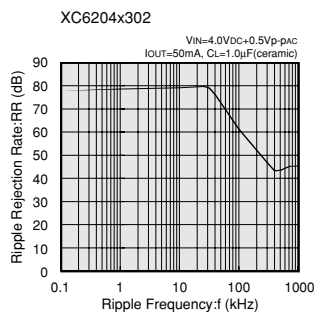

XC6204 Series

Pin Configuration

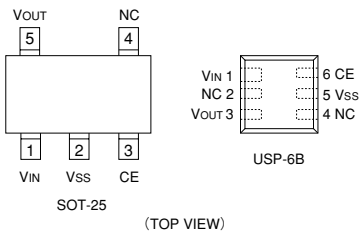

Pin Assignment

PIN NUMBER		PIN NAME	FUNCTION
SOT-25	USP-6B		
1	1	VIN	Input
2	5	VSS	Ground
3	6	CE	ON/OFF Control
4	2, 4	NC	No Connection
5	3	VOUT	Output

3

Product Classification

Selection Guide

The following options for the CE pin logic and internal pull-up/down are available:

- Active 'High' + no pull-down resistor built-in (standard)
- Active 'High' + 300kΩ pull-down resistor built-in <between CE-VSS> (semi-custom)
- Active 'Low' + no pull-up resistor built-in (semi-custom)
- Active 'Low' + 300kΩ pull-up resistor built-in <between CE-VSS> (semi-custom)

Note: *With the pull-up resistor or pull-down resistor built-in types, the supply current during operation will increase by $V_{IN} / 300k\Omega$ (TYP.)

Ordering Information

XC6204 ①②③④⑤⑥

DESIGNATOR	SYMBOL	DESCRIPTION
①	A	Active 'High' (pull-down resistor built in)
	B	Active 'High' (no pull-down resistor built in)
	C	Active 'Low' (pull-up resistor built in)
	D	Active 'Low' (no pull-up resistor built in)
②③	18~16	Output Voltage : e.g. 20 = 2.0V, 30 = 3.0V etc.
④	2	Output Voltage : 100mV increments, ± 2% accuracy e.g. ②=3, ③=8, ④=2 ⇒ 3.8V, ± 2%
	1 (Note1)	Output Voltage : 100mV increments, ± 1% accuracy e.g. ②=3, ③=0, ④=1 ⇒ 3.0V, ± 1%
	A	Output Voltage : 50mV increments, ± 2% accuracy e.g. ②=3, ③=8, ④=A ⇒ 3.85V
	B (Note1)	Output Voltage : 50mV increments, ± 1% accuracy e.g. ②=3, ③=0, ④=B ⇒ 3.05V, ± 1%
⑤	M	SOT-25
	D	USP-6B
⑥	R	Embossed Tape : Standard Feed
	L	Embossed Tape : Reverse Feed

Please note that the "B" version is the standard part. The A, C, & D versions are semi-custom parts.
Note 1 : The output voltage range of the ±1% accuracy product is 3.0V ~ 6.0V.

■ Packaging Information

● SOT-25

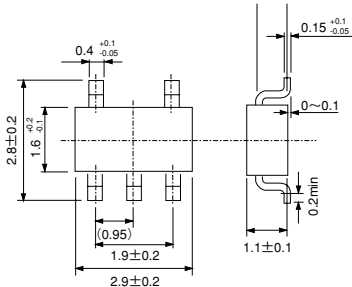

3

● USP-6B

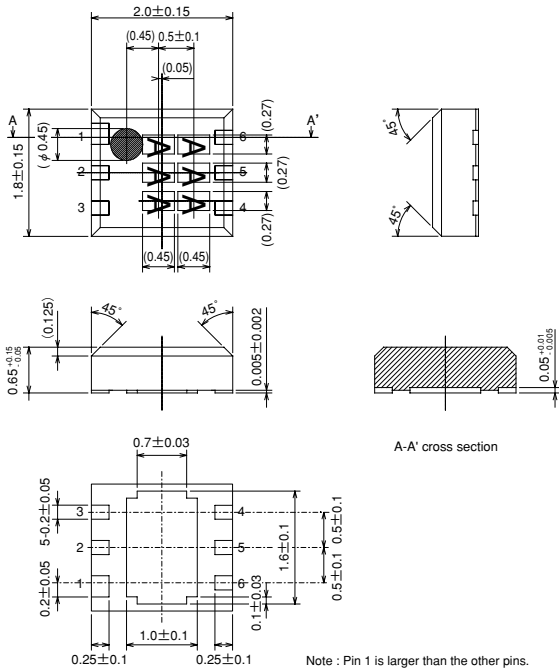

XC6204 Series

■ Marking

● SOT-25

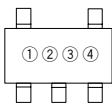

SOT-25
(TOP VIEW)

① Represents the product name

DESIGNATOR	PRODUCT NAME
4	XC6204 * * * M *

② Represents the type of regulator

DESIGNATOR				PRODUCT NAME
Output Voltage 100mV step		Output Voltage 50mV step		
Voltage = 0.1~3.0V	Voltage = 3.1~6.0V	Voltage = 0.15~3.05V	Voltage = 3.15~6.05V	
V	A	E	L	XC6204A * * * M *
X	B	F	M	XC6204B * * * M *
Y	C	H	N	XC6204C * * * M *
Z	D	K	P	XC6204D * * * M *

③ Represents the output voltage

DESIGNATOR	Output Voltage (V)				DESIGNATOR	Output Voltage (V)			
0	—	3.1	—	3.15	F	1.6	4.6	1.65	4.65
1	—	3.2	—	3.25	H	1.7	4.7	1.75	4.75
2	—	3.3	—	3.35	K	1.8	4.8	1.85	4.85
3	—	3.4	—	3.45	L	1.9	4.9	1.95	4.95
4	—	3.5	—	3.55	M	2.0	5.0	2.05	5.05
5	—	3.6	—	3.65	N	2.1	5.1	2.15	5.15
6	—	3.7	—	3.75	P	2.2	5.2	2.25	5.25
7	—	3.8	—	3.85	R	2.3	5.3	2.35	5.35
8	—	3.9	—	3.95	S	2.4	5.4	2.45	5.45
9	—	4.0	—	4.05	T	2.5	5.5	2.55	5.55
A	—	4.1	—	4.15	U	2.6	5.6	2.65	5.65
B	—	4.2	—	4.25	V	2.7	5.7	2.75	5.75
C	—	4.3	—	4.35	X	2.8	5.8	2.85	5.85
D	—	4.4	—	4.45	Y	2.9	5.9	2.95	5.95
E	—	4.5	—	4.55	Z	3.0	6.0	3.05	6.05

④ Denotes the production lot number
0 to 9, A to Z repeated (G, I, J, O, Q, W excepted)

● USP-6B

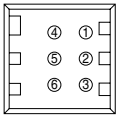

USP6B
(TOP VIEW)

①② Represents the product name

DESIGNATOR		PRODUCT NAME
①	②	
0	4	XC6204***D*

③ Represents the type of regulator

DESIGNATOR	Type	PRODUCT NAME
A	CE pin, Active 'High' pull-down resistor built in	XC6204A***D*
B	CE pin, Active 'High' no pull-down resistor built in	XC6204B***D*
C	CE pin, Active 'High' pull-up resistor built in	XC6204C***D*
D	CE pin, Active 'High' no pull-up resistor built in	XC6204D***D*

④ Represents the integer of the Output Voltage

DESIGNATOR	VOLTAGE (V)	PRODUCT NAME
3	3.X	XC6204*3**D*
5	5.X	XC6204*5**D*

⑤ Represents the decimal number of Output Voltage

DESIGNATOR	VOLTAGE (V)	PRODUCT NAME	DESIGNATOR	VOLTAGE (V)	PRODUCT NAME
0	X.0	XC6204**0*D*	A	X.05	XC6204**0AD*
1	X.1	XC6204**1*D*	B	X.15	XC6204**1AD*
2	X.2	XC6204**2*D*	C	X.25	XC6204**2AD*
3	X.3	XC6204**3*D*	D	X.35	XC6204**3AD*
4	X.4	XC6204**4*D*	E	X.45	XC6204**4AD*
5	X.5	XC6204**5*D*	F	X.55	XC6204**5AD*
6	X.6	XC6204**6*D*	H	X.65	XC6204**6AD*
7	X.7	XC6204**7*D*	K	X.75	XC6204**7AD*
8	X.8	XC6204**8*D*	L	X.85	XC6204**8AD*
9	X.9	XC6204**9*D*	M	X.95	XC6204**9AD*

⑥ Denotes the production lot number
0 to 9, A to Z repeated(G,I,J,O,Q,W excepted)

Note : Character inversion is not used.

3

XC6204 Series

Block Diagram

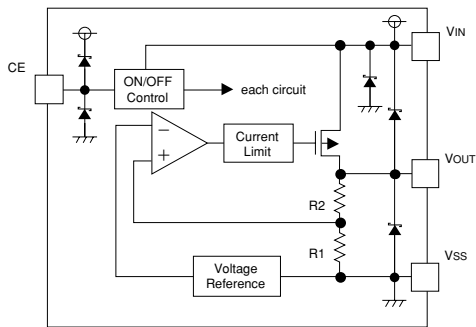

The diode in the circuit above is the protective diode.

3

Absolute Maximum Ratings

PARAMETER	SYMBOL	RATINGS	UNITS
Input Voltage	VIN	12	V
Output Current	IOUT	500	mA
Output Voltage	VOUT	$V_{SS}-0.3 \sim V_{IN}+0.3$	V
CE Input Voltage	VCE	$V_{SS}-0.3 \sim V_{IN}+0.3$	V
Power Dissipation	SOT-25	Pd	mW
	USP-6B		
Operational Ambient Temperature	Topr	$-40 \sim +85$	°C
Storage Temperature	Tstg	$-55 \sim +125$	°C

※ IOUT= the range of Pd/ (VIN-VOUT)

Electrical Characteristics

XC6204A, B Series										
PARAMETER	SYMBOL	CONDITIONS	Ta=25°C			-40°C≤Ta≤85°C			UNITS	CIRCUIT
			MIN.	TYP.	MAX.	MIN.	TYP.	MAX.		
Output Voltage	VOUT(E)	IOUT=30mA	×0.98	VOUT(T)	×1.02	×0.97	VOUT(T)	×1.03	V	1
Maximum Output Current	IOUT MAX		150			150			mA	1
Load Regulation	ΔVOUT	1mA≤IOUT≤100mA		15	50		30	80	mV	1
Dropout Voltage	Vdif1	IOUT=30mA	E-1						mV	1
	Vdif2	IOUT=100mA	E-2						mV	
Supply Current (A series)	IDD	VIN=VCE=VOUT(T)+1.0V	50	80	120	50	90	145	μA	2
Supply Current (B series)		VIN=VCE=VOUT(T)+1.0V	40	70	100	40	80	120		
Standby Current	Istby	VIN=VOUT(T)+1.0V, VCE=VSS		0.01	0.10		0.05	1.00	μA	2
Line Regulation	$\frac{\Delta V_{OUT}}{\Delta V_{IN} \cdot V_{OUT}}$	VOUT(T)+1.0V≤VIN≤10V IOUT=30mA		0.01	0.20		0.05	0.30	%/V	1
Input Voltage	VIN		2		10	2		10	V	-
Output Voltage Temp. Characteristics	$\frac{\Delta V_{OUT}}{\Delta T_{opr} \cdot V_{OUT}}$	IOUT=30mA -40°C≤Topr≤85°C		100					ppm/°C	1
Output Noise	en	IOUT=10mA 300Hz~50kHz		30					μVrms	3
Ripple Rejection Rate	PSRR	VIN=[VOUT(T)+1.0]V+1.0Vp-pac IOUT=50mA, f=10kHz		70					dB	4
Current Limiter	Ilim	VIN=VOUT(T)+1.0V, VCE=VIN		300			280		mA	1
Short-circuit Current	Ishort	VIN=VOUT(T)+1.0V, VCE=VIN		50			60		mA	1
CE "High" Voltage	VCEH		1.6		VIN	1.7		VIN	V	1
CE "Low" Voltage	VCEL				0.25			0.20	V	1
CE "High" Current (A series)	ICEH	VIN=VCE=VOUT(T)+1.0V	-0.10		20	-0.15		25	μA	2
CE "High" Current (B series)	ICEH	VIN=VCE=VOUT(T)+1.0V	-0.10		0.10	-0.15		0.15	μA	2
CE "Low" Current	ICEL	VIN=VOUT(T)+1.0V, VCE=VSS	-0.10		0.10	-0.15		0.15	μA	2

3

Note
 (NOTE 1) Unless otherwise stated, VIN=VOUT(T)+1.0V
 (NOTE 2) VOUT(T)=Specified Output Voltage
 (NOTE 3) VOUT(E)=Effective Output Voltage (I.e. the output voltage when "Vout(T)+1.0V" is provided at the VIN pin while maintaining a certain Iout value).
 (NOTE 4) Vdif={VIN1(NOTE6)-VOUT1(NOTE5)}
 (NOTE 5) VOUT1=A voltage equal to 98% of the Output Voltage whenever an amply stabilized IOUT (VOUT(T)+1.0V) is input.
 (NOTE 6) VIN1=The Input Voltage when VOUT1 appears as Input Voltage is gradually decreased.
 (NOTE 7) The values for -40°C≤Topr≤85°C are designed values.

XC6204 Series

XC6204C, D Series										
PARAMETER	SYMBOL	CONDITIONS	Ta=25°C			-40°C≤Ta≤85°C			UNITS	CIRCUIT
			MIN.	TYP.	MAX.	MIN.	TYP.	MAX.		
Output Voltage	V _{OUT} (E)	I _{OUT} =30mA	×0.98	V _{OUT} (T)	×1.02	×0.97	V _{OUT} (T)	×1.03	V	1
Maximum Output Current	I _{OUT} MAX		150			150			mA	1
Load Regulation	ΔV _{OUT}	1mA≤I _{OUT} ≤100mA		15	50		30	80	mV	1
Dropout Voltage	V _{dif1}	I _{OUT} =30mA	E-1						mV	1
	V _{dif2}	I _{OUT} =100mA	E-2						mV	
Supply Current (C series)	I _{DD}	V _{IN} =V _{OUT} (T)+1.0V, V _{CE} =V _{SS}	50	80	120	50	90	145	μA	2
Supply Current (D series)		V _{IN} =V _{OUT} (T)+1.0V, V _{CE} =V _{SS}	40	70	100	40	80	120		
Standby Current	I _{stby}	V _{IN} =V _{CE} =V _{OUT} (T)+1.0V		0.01	0.10		0.05	1.00	μA	2
Line Regulation	$\frac{\Delta V_{OUT}}{\Delta V_{IN}-V_{OUT}}$	V _{OUT} (T)+1.0V≤V _{IN} ≤10V I _{OUT} =30mA		0.01	0.20		0.05	0.30	%/V	1
Input Voltage	V _{IN}		2		10	2		10	V	-
Output Voltage Temp. Characteristics	$\frac{\Delta V_{OUT}}{\Delta T_{opr}-V_{OUT}}$	I _{OUT} =30mA -40°C≤T _{opr} ≤85°C		100					ppm/°C	1
Output Noise	en	I _{OUT} =10mA 300Hz~50kHz		30					μVrms	3
Ripple Rejection Rate	PSRR	V _{IN} =[V _{OUT} (T)+1.0]V+1.0Vp-pAC I _{OUT} =50mA, f=10kHz		70					dB	4
Current Limiter	I _{lim}	V _{IN} =V _{OUT} (T)+1.0V, V _{CE} =V _{SS}		300			280		mA	1
Short-circuit Current	I _{short}	V _{IN} =V _{OUT} (T)+1.0V, V _{CE} =V _{SS}		50			60		mA	1
CE "High" Voltage	V _{CEH}		1.6		V _{IN}	1.7		V _{IN}	V	1
CE "Low" Voltage	V _{CEL}				0.25		0.20		V	1
CE "High" Current	I _{CEH}	V _{IN} =V _{CE} =V _{OUT} (T)+1.0V	-0.10		0.10	-0.15		0.15	μA	2
CE "Low" Current (C series)	I _{CEL}	V _{IN} =V _{OUT} (T)+1.0V, V _{CE} =V _{SS}	-20		0.10	-25		0.15	μA	2
CE "Low" Current (D series)	I _{CEL}	V _{IN} =V _{OUT} (T)+1.0V, V _{CE} =V _{SS}	-0.10		0.10	-0.15		0.15	μA	2

Note

(NOTE 1) Unless otherwise stated, V_{IN}=V_{OUT}(T)+1.0V

(NOTE 2) V_{OUT}(T)=Specified Output Voltage

(NOTE 3) V_{OUT}(E)=Effective Output Voltage (i.e. the output voltage when "V_{OUT}(T)+1.0V" is provided at the V_{IN} pin while maintaining a certain I_{OUT} value).

(NOTE 4) V_{dif}={V_{IN}(NOTE6)-V_{OUT1}(NOTE5)}

(NOTE 5) V_{OUT1}=A voltage equal to 98% of the Output Voltage whenever an amply stabilized I_{OUT} (V_{OUT}(T)+1.0V) is input.

(NOTE 6) V_{IN1}=The Input Voltage when V_{OUT1} appears as Input Voltage is gradually decreased.

(NOTE 7) The values for -40°C≤T_{opr}≤85°C are designed values.

Dropout Voltage 1

SYMBOL PARAMETER OUTPUT VOLTAGE	E-0		E-1				E-2			
	Output Voltage (V)		Dropout Voltage 1 (mV) (I _{OUT} =30mA)				Dropout Voltage 2 (mV) (I _{OUT} =100mA)			
			T _a =25°C		-40°C≤T _{opr} ≤85°C		T _a =25°C		-40°C≤T _{opr} ≤85°C	
	V _{OUT}		V _{dif1} 1V	V _{dif1}	V _{dif1} 1V	V _{dif1}	V _{dif2} 2V	V _{dif2}	V _{dif2} 2V	V _{dif2}
V _{OUT} (T)	MIN	MAX	TYP	MAX	TYP	MAX	TYP	MAX	TYP	MAX
1.80	1.764	1.836	200	210	210	230	300	400	340	480
1.85	1.813	1.887	200	210	210	230	300	400	340	480
1.90	1.862	1.938	120	150	130	170	280	380	320	460
1.95	1.911	1.989	120	150	130	170	280	380	320	460
2.00	1.960	2.040	80	120	90	140	240	350	280	430
2.05	2.009	2.091	80	120	90	140	240	350	280	430
2.10	2.058	2.142	80	120	90	140	240	330	280	410
2.15	2.107	2.193	80	120	90	140	240	330	280	410
2.20	2.156	2.244	80	120	90	140	240	330	280	410
2.25	2.205	2.295	80	120	90	140	240	330	280	410
2.30	2.254	2.346	80	120	90	140	240	310	280	390
2.35	2.303	2.397	80	120	90	140	240	310	280	390
2.40	2.352	2.448	80	120	90	140	240	310	280	390
2.45	2.401	2.499	80	120	90	140	240	310	280	390
2.50	2.450	2.550	70	100	80	120	220	290	260	370
2.55	2.499	2.601	70	100	80	120	220	290	260	370
2.60	2.548	2.652	70	100	80	120	220	290	260	370
2.65	2.597	2.703	70	100	80	120	220	290	260	370
2.70	2.646	2.754	70	100	80	120	220	290	260	370
2.75	2.695	2.805	70	100	80	120	220	290	260	370
2.80	2.744	2.856	70	100	80	120	220	270	260	350
2.85	2.793	2.907	70	100	80	120	220	270	260	350
2.90	2.842	2.958	70	100	80	120	220	270	260	350
2.95	2.891	3.009	70	100	80	120	220	270	260	350
3.00	2.940	3.060	60	90	70	110	200	270	240	350
3.05	2.989	3.111	60	90	70	110	200	270	240	350
3.10	3.038	3.162	60	90	70	110	200	250	240	330
3.15	3.087	3.213	60	90	70	110	200	250	240	330
3.20	3.136	3.264	60	90	70	110	200	250	240	330

XC6204 Series

Dropout Voltage 2

SYMBOL PARAMETER OUTPUT VOLTAGE	E-0		E-1				E-2			
	Output Voltage (V)		Dropout Voltage 1 (mV) (I _{OUT} =30mA)				Dropout Voltage 2 (mV) (I _{OUT} =100mA)			
	V _{OUT}		T _a =25°C		-40°C≤T _{op} ≤85°C		T _a =25°C		-40°C≤T _{op} ≤85°C	
	MIN	MAX	V _{dif1} TYP	V _{dif1} MAX	V _{dif1} TYP	V _{dif1} MAX	V _{dif2} TYP	V _{dif2} MAX	V _{dif2} TYP	V _{dif2} MAX
3.25	3.185	3.315	60	90	70	110	200	250	240	330
3.30	3.234	3.366	60	90	70	110	200	250	240	330
3.35	3.283	3.417	60	90	70	110	200	250	240	330
3.40	3.332	3.468	60	90	70	110	200	250	240	330
3.45	3.381	3.519	60	90	70	110	200	250	240	330
3.50	3.430	3.570	60	90	70	110	200	250	240	330
3.55	3.479	3.621	60	90	70	110	200	250	240	330
3.60	3.528	3.672	60	90	70	110	200	250	240	330
3.65	3.577	3.723	60	90	70	110	200	250	240	330
3.70	3.626	3.774	60	90	70	110	200	250	240	330
3.75	3.675	3.825	60	90	70	110	200	250	240	330
3.80	3.724	3.876	60	90	70	110	200	250	240	330
3.85	3.773	3.927	60	90	70	110	200	250	240	330
3.90	3.822	3.978	60	90	70	110	200	250	240	330
3.95	3.871	4.029	60	90	70	110	200	250	240	330
4.00	3.920	4.080	60	80	70	100	180	230	220	310
4.05	3.969	4.131	60	80	70	100	180	230	220	310
4.10	4.018	4.182	60	80	70	100	180	230	220	310
4.15	4.067	4.233	60	80	70	100	180	230	220	310
4.20	4.116	4.284	60	80	70	100	180	230	220	310
4.25	4.165	4.335	60	80	70	100	180	230	220	310
4.30	4.214	4.386	60	80	70	100	180	230	220	310
4.35	4.263	4.437	60	80	70	100	180	230	220	310
4.40	4.312	4.488	60	80	70	100	180	230	220	310
4.45	4.361	4.539	60	80	70	100	180	230	220	310
4.50	4.410	4.590	60	80	70	100	180	230	220	310
4.55	4.459	4.641	60	80	70	100	180	230	220	310
4.60	4.508	4.692	60	80	70	100	180	230	220	310
4.65	4.557	4.743	60	80	70	100	180	230	220	310

Dropout Voltage 3

SYMBOL PARAMETER OUTPUT VOLTAGE	E-0		E-1				E-2			
	Output Voltage (V)		Dropout Voltage 1 (mV) (I _{OUT} =30mA)				Dropout Voltage 2 (mV) (I _{OUT} =100mA)			
	V _{OUT}		T _a =25°C		-40°C≤T _{opr} ≤85°C		T _a =25°C		-40°C≤T _{opr} ≤85°C	
			V _{dif1}	V _{dif1}	V _{dif1}	V _{dif1}	V _{dif2}	V _{dif2}	V _{dif2}	V _{dif2}
MIN	MAX	TYP	MAX	TYP	MAX	TYP	MAX	TYP	MAX	
4.70	4.606	4.794	60	80	70	100	180	230	220	310
4.75	4.655	4.845	60	80	70	100	180	230	220	310
4.80	4.704	4.896	60	80	70	100	180	230	220	310
4.85	4.753	4.947	60	80	70	100	180	230	220	310
4.90	4.802	4.998	60	80	70	100	180	230	220	310
4.95	4.851	5.049	60	80	70	100	180	230	220	310
5.00	4.900	5.100	50	70	60	90	160	210	200	290
5.05	4.949	5.151	50	70	60	90	160	210	200	290
5.10	4.998	5.202	50	70	60	90	160	210	200	290
5.15	5.047	5.253	50	70	60	90	160	210	200	290
5.20	5.096	5.304	50	70	60	90	160	210	200	290
5.25	5.145	5.355	50	70	60	90	160	210	200	290
5.30	5.194	5.406	50	70	60	90	160	210	200	290
5.35	5.243	5.457	50	70	60	90	160	210	200	290
5.40	5.292	5.508	50	70	60	90	160	210	200	290
5.45	5.341	5.559	50	70	60	90	160	210	200	290
5.50	5.390	5.610	50	70	60	90	160	210	200	290
5.55	5.439	5.661	50	70	60	90	160	210	200	290
5.60	5.488	5.712	50	70	60	90	160	210	200	290
5.65	5.537	5.763	50	70	60	90	160	210	200	290
5.70	5.586	5.814	50	70	60	90	160	210	200	290
5.75	5.635	5.865	50	70	60	90	160	210	200	290
5.80	5.684	5.916	50	70	60	90	160	210	200	290
5.85	5.733	5.967	50	70	60	90	160	210	200	290
5.90	5.782	6.018	50	70	60	90	160	210	200	290
5.95	5.831	6.069	50	70	60	90	160	210	200	290
6.00	5.880	6.120	50	70	60	90	160	210	200	290

3

■ Typical Application Circuit

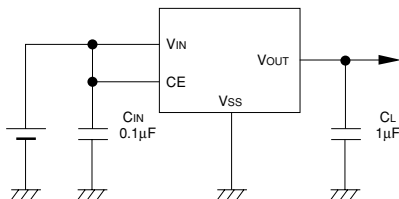

XC6204 Series

Operational Explanation

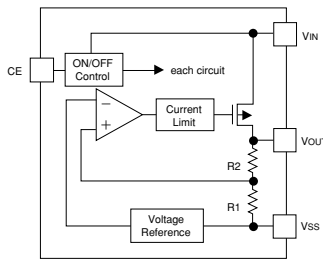

Output voltage control with the XC6204 series :

The voltage divided by resistors R1 & R2 is compared with the internal reference voltage by the error amplifier.

The P-Channel MOSFET, which is connected to the Vout pin, is then driven by the subsequent output signal. The output voltage at the Vout pin is controlled & stabilised by a system of negative feedback.

The current limit circuit and short protect circuit operate in relation to the level of output current. Further, the IC's internal circuitry can be shutdown via the CE pin's signal.

3

<Low ESR Capacitors>

With the XC6204 series, a stable output voltage is achievable even if used with low ESR capacitors as a phase compensation circuit is built-in. In order to ensure the effectiveness of the phase compensation, we suggest that an output capacitor (C_L) is connected as close as possible to the output pin (V_{OUT}) and the V_{SS} pin. Please use an output capacitor with a capacitance value of at least 1μF. Also, please connect an input capacitor (C_{IN}) of 0.1μF between the V_{IN} pin and the V_{SS} pin in order to ensure a stable power input.

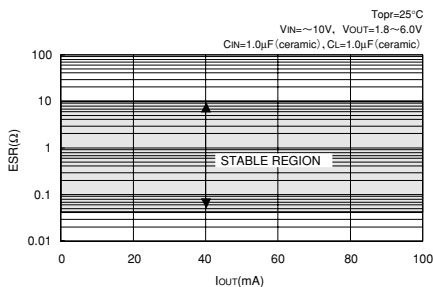

<Current Limiter, Short-Circuit Protection>

The XC6204 series includes a combination of a fixed current limiter circuit & a foldback circuit which aid the operations of the current limiter and circuit protection. When the load current reaches the current limit level, the fixed current limiter circuit operates and output voltage drops. As a result of this drop in output voltage, the foldback circuit operates, output voltage drops further and output current decreases (refer to the data on page 5). When the output pin is shorted, a current of about 60mA flows.

<CE Pin>

The IC's internal circuitry can be shutdown via the signal from the CE pin with the XC6204 series. In shutdown mode, output at the V_{OUT} pin will be pulled down to the V_{SS} level via R1 & R2. The operational logic of the IC's CE pin is selectable (please refer to the selection guide on page 2). Note that as the standard XC6204B type is 'High Active/No Pull Down', operations will become unstable with the CE pin open. Although the CE pin is equal to an inverter input with CMOS hysteresis, with either the pull-up or pull-down options, the CE pin input current will increase when the IC is in operation.

We suggest that you use this IC with either a V_{IN} voltage or a V_{SS} voltage input at the CE pin. If this IC is used with the correct specifications for the CE pin, the IC will operate normally. However, supply current may increase as a result of through current in the IC's internal circuitry if a voltage between 0.25V and 1.5V is input.

Directions for use

Notes on Use

1. Please use this IC within the stated absolute maximum ratings. The IC is liable to malfunction should the ratings be exceeded.
2. Where wiring impedance is high, operations may become unstable due to noise and/or phase lag depending on output current. Please strengthen V_{IN} and V_{SS} wiring in particular.
3. Please wire the input capacitor (C_{IN}) and the output capacitor (C_L) as close to the IC as possible.

Test Circuits

Circuit 1

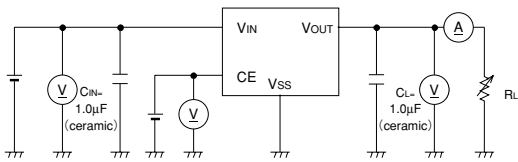

Circuit 2

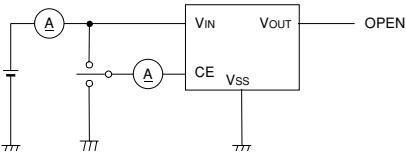

Circuit 3

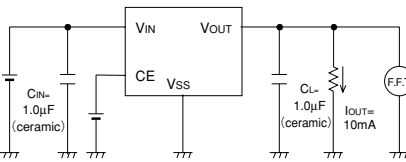

Circuit 4

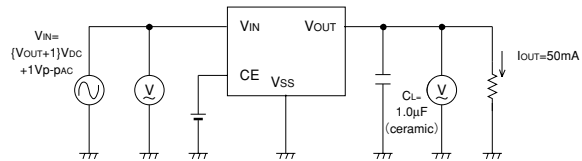

3

XC6204 Series

Typical Performance Characteristics

(1) OUTPUT VOLTAGE vs. OUTPUT CURRENT

3

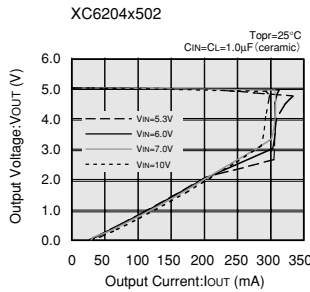
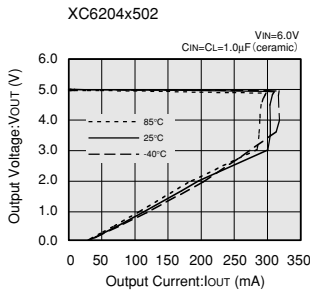
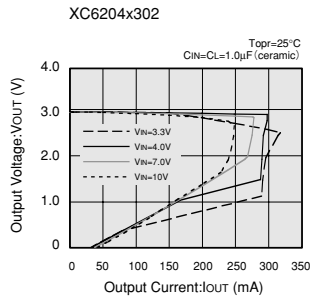
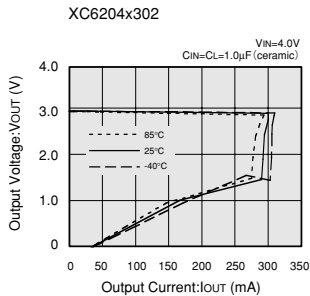
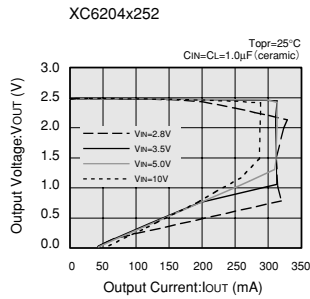
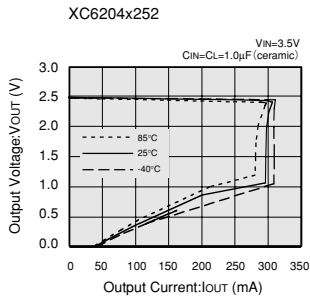
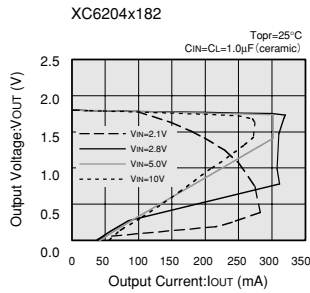
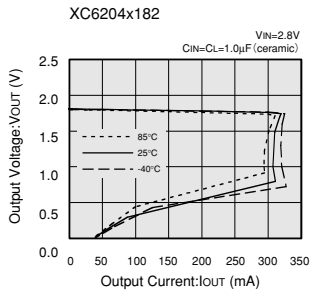

(2) OUTPUT VOLTAGE vs. INPUT VOLTAGE

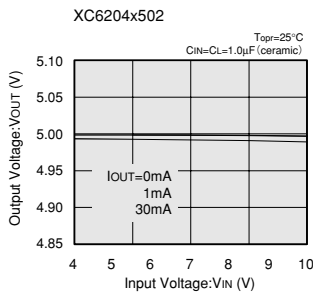
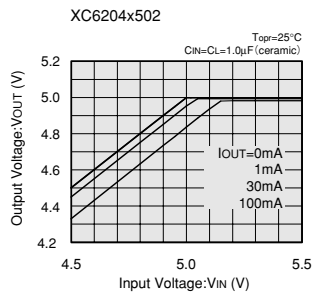
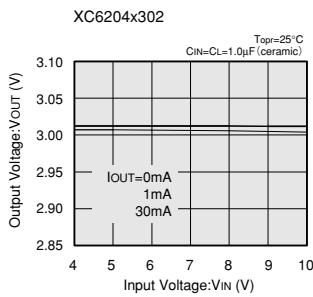
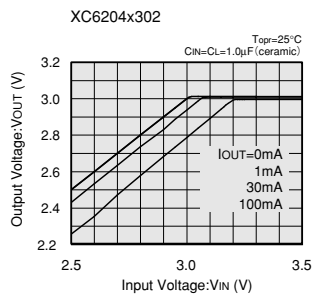
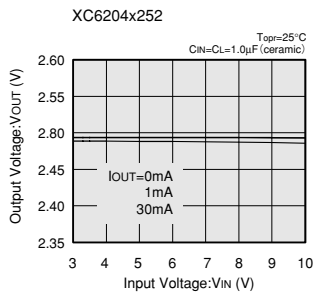
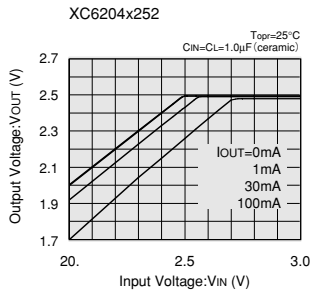
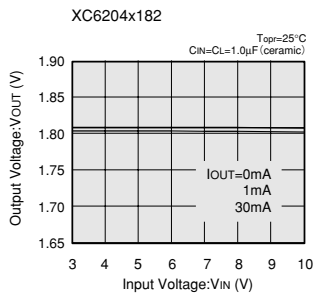
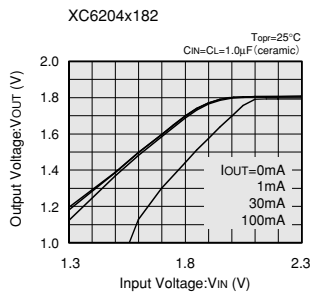

XC6204 Series

(3) DROPOUT VOLTAGE vs. OUTPUT CURRENT

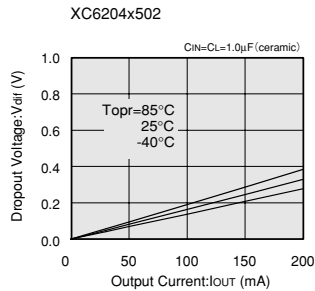
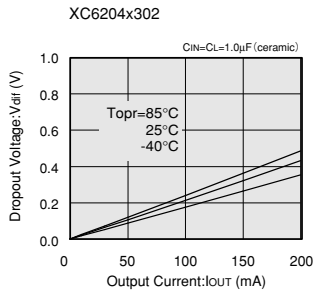
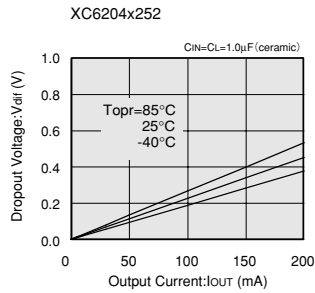
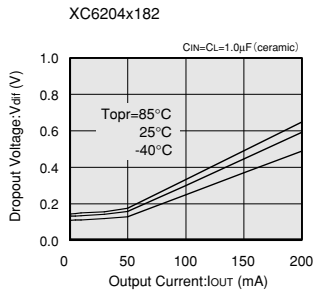

(4) SUPPLY CURRENT vs. INPUT VOLTAGE

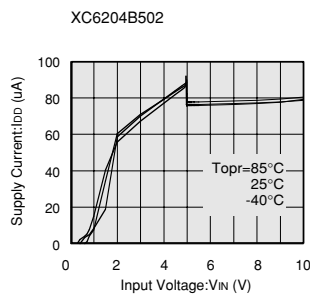
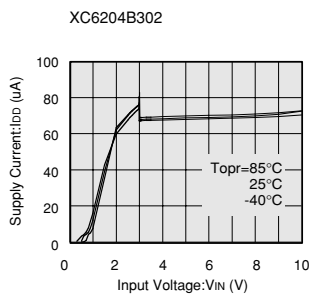
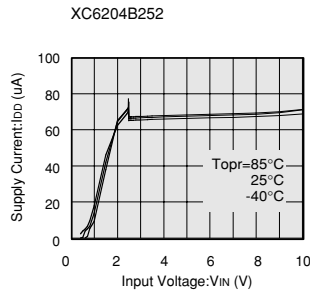
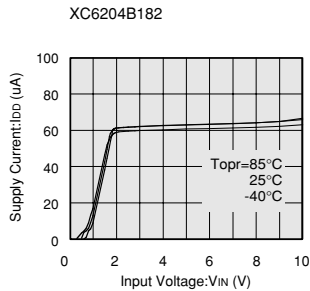

(5) OUTPUT VOLTAGE vs. AMBIENT TEMPERATURE

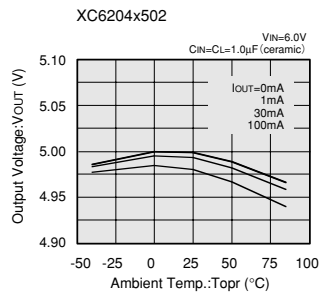
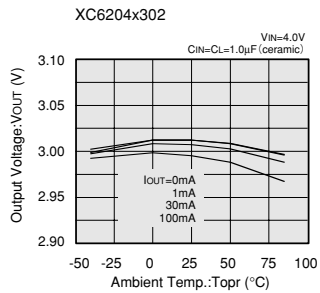
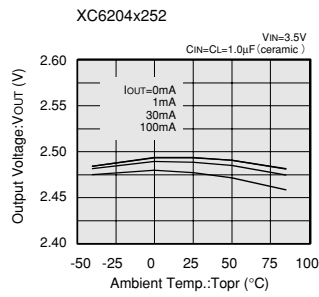
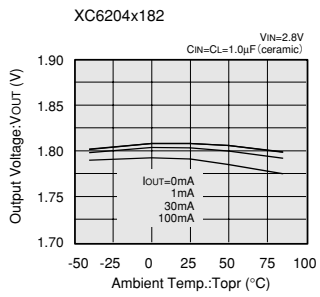

3

(6) SUPPLY CURRENT vs. AMBIENT TEMPERATURE

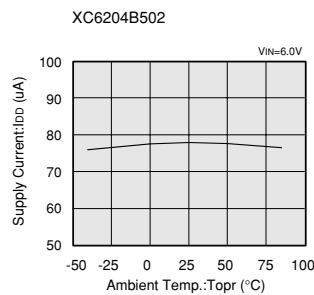
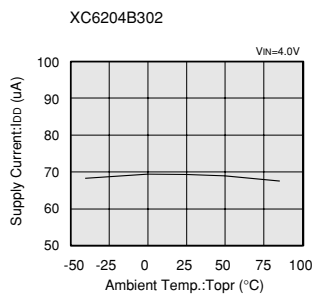
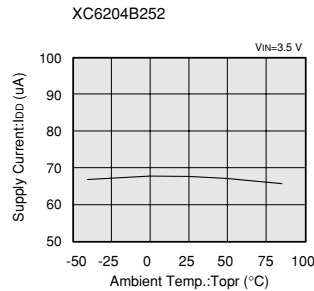
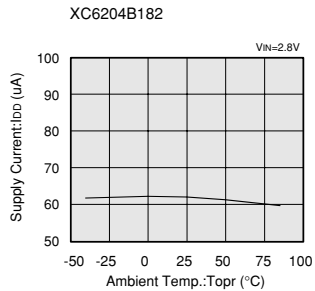

XC6204 Series

(7) CE PIN THRESHOLD VOLTAGE vs. AMBIENT TEMPERATURE

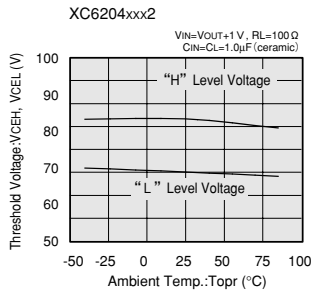

3

(8) INPUT TRANSIENT RESPONSE

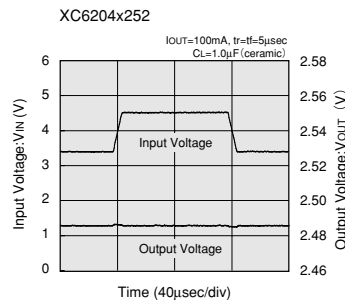
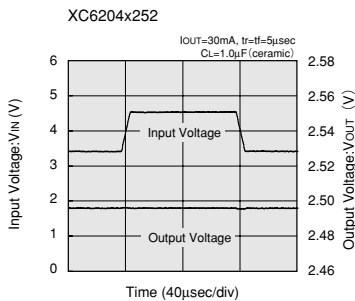
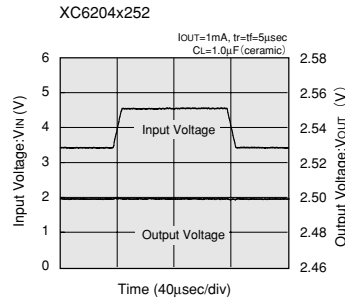
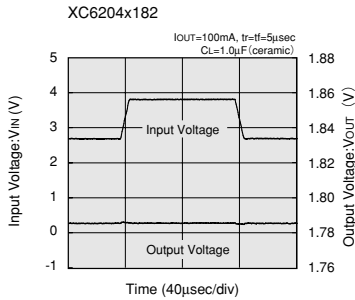
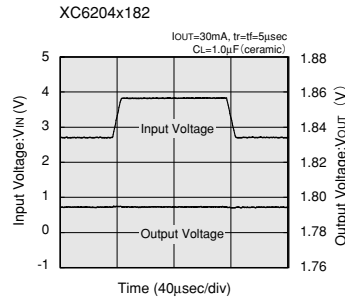
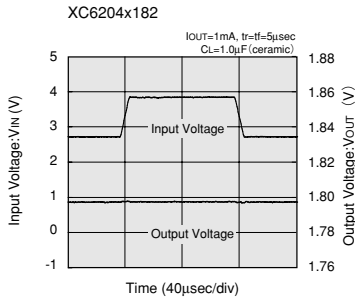

(8) INPUT TRANSIENT RESPONSE

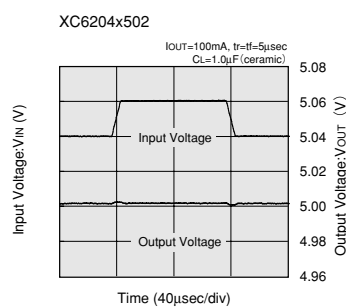
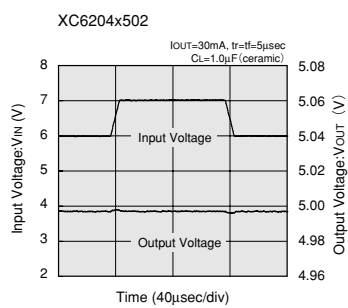
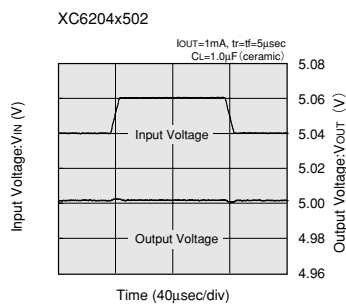
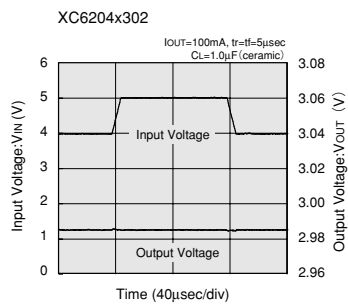
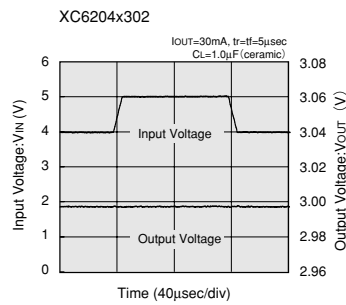
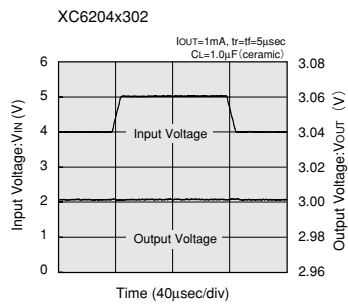

XC6204 Series

(9) LOAD TRANSIENT RESPONSE

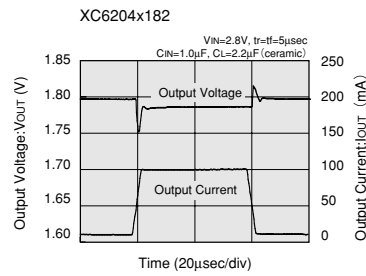
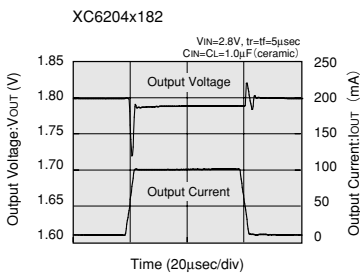
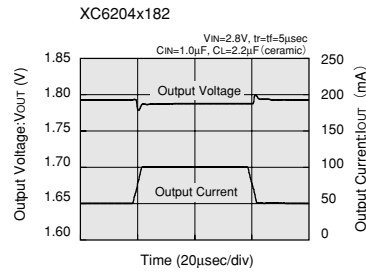
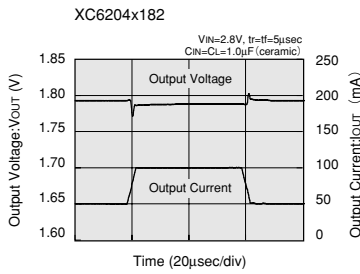
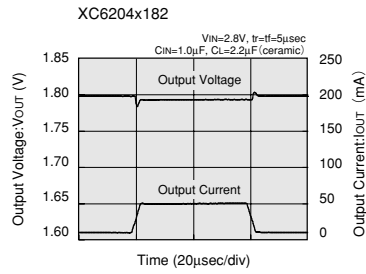
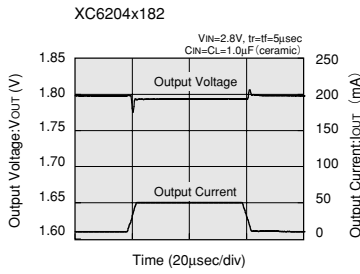

(9) LOAD TRANSIENT RESPONSE

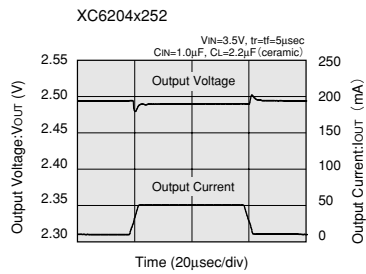
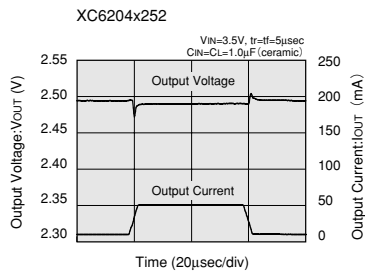

3

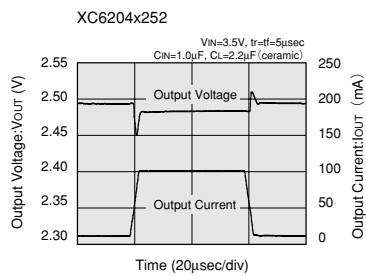
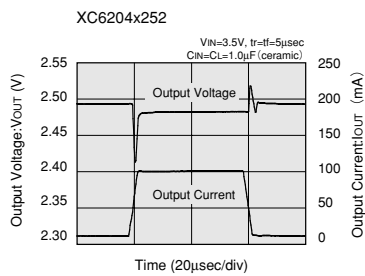
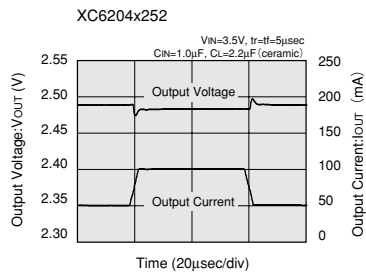
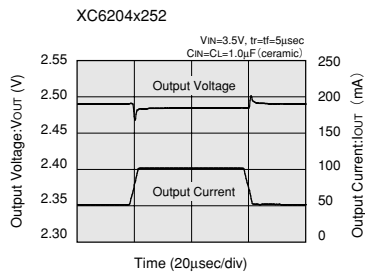

XC6204 Series

(9) LOAD TRANSIENT RESPONSE

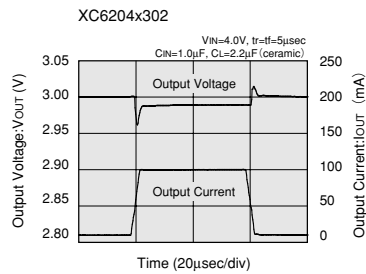
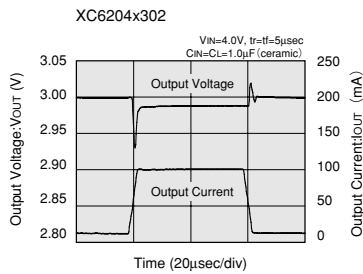
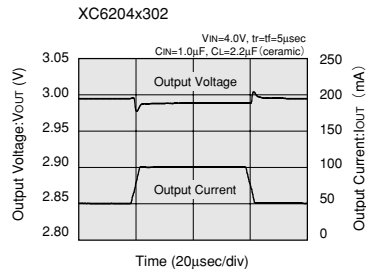
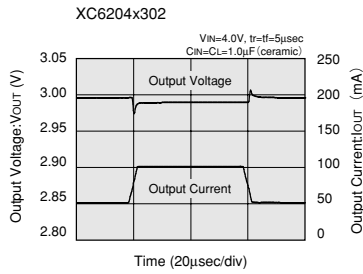
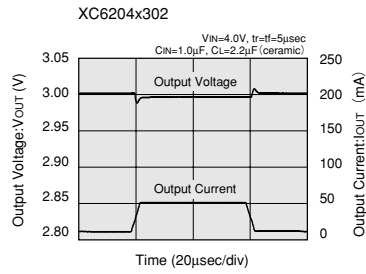
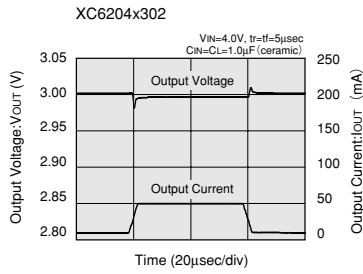

(9) LOAD TRANSIENT RESPONSE

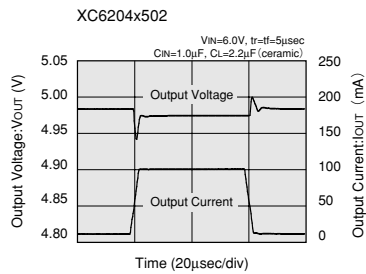
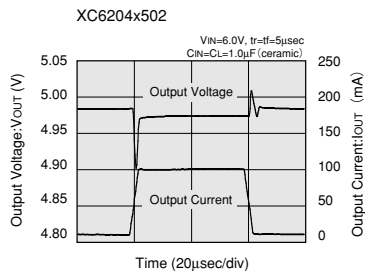
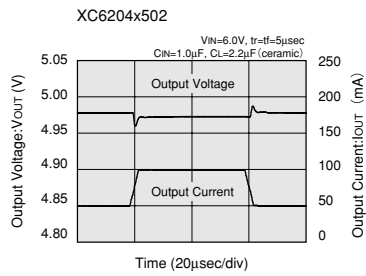
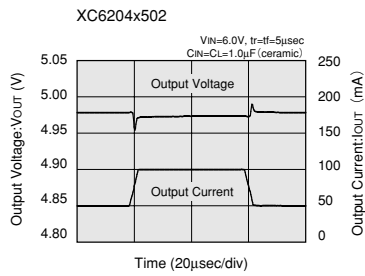
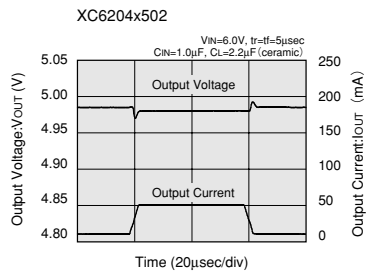
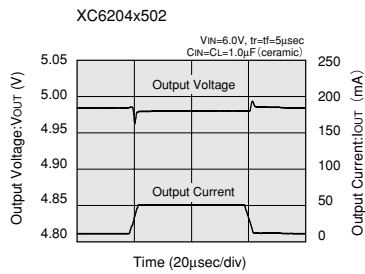

XC6204 Series

(10) TURN-ON RESPONSE TIME

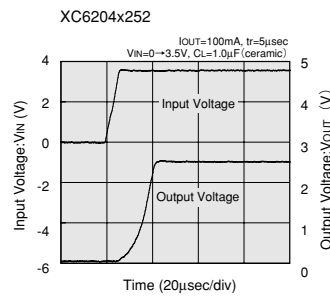
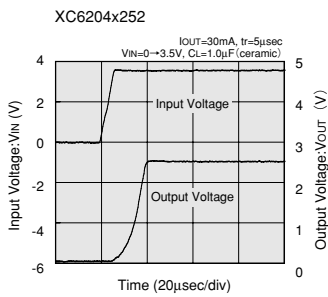
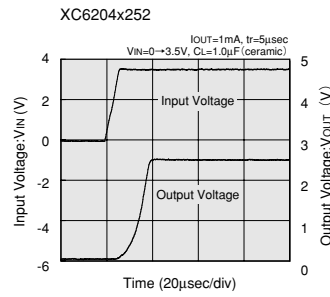
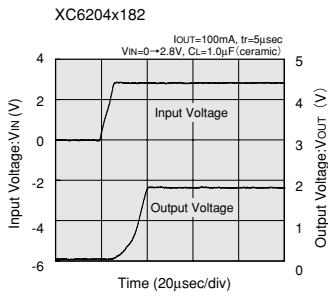
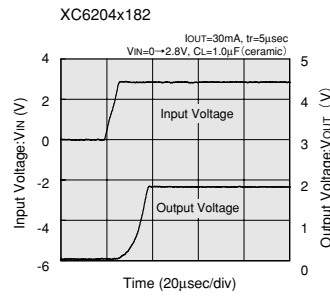
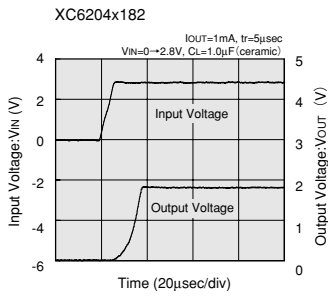

(10) TURN-ON RESPONSE TIME

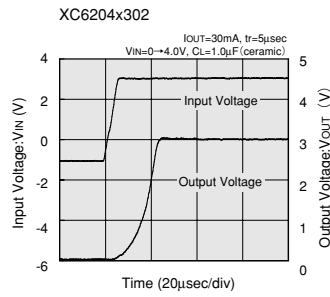
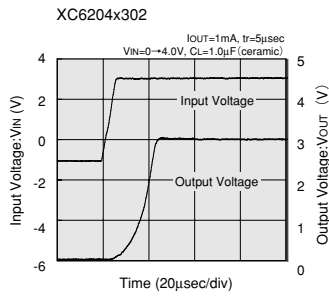

3

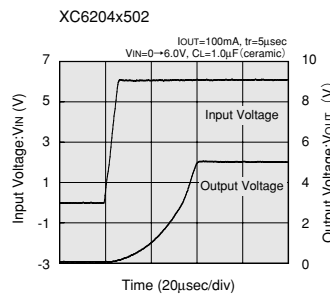
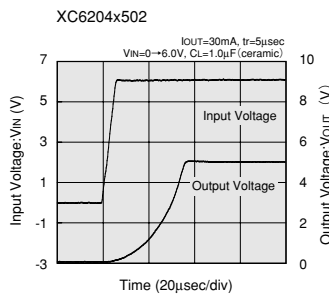
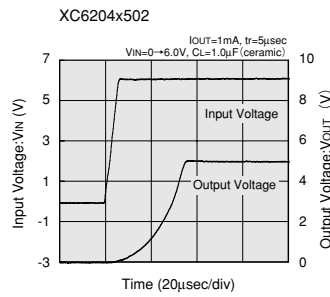
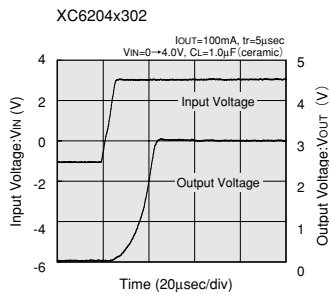

XC6204 Series

(11) ENABLE RESPONSE TIME (These characteristics will not be affected by the nature of the CE pin's logic)

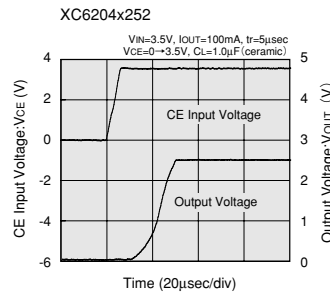
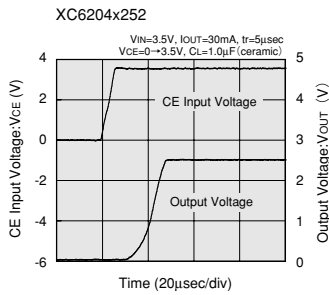
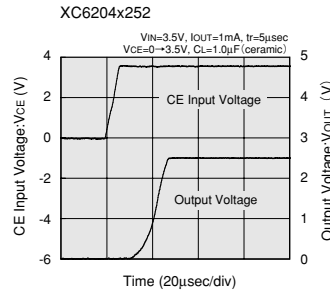
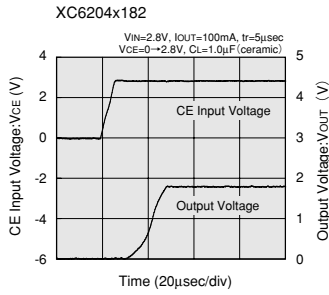
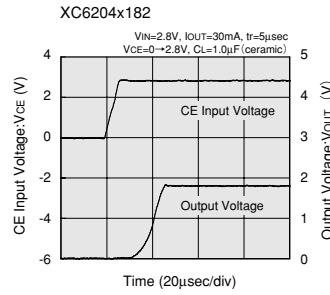
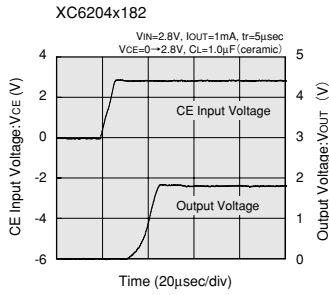

(11) ENABLE RESPONSE TIME (These characteristics will not be affected by the nature of the CE pin's logic)

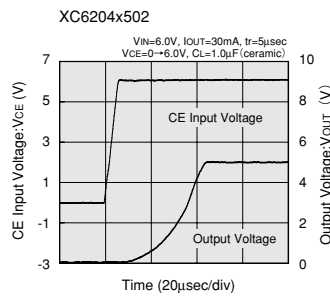
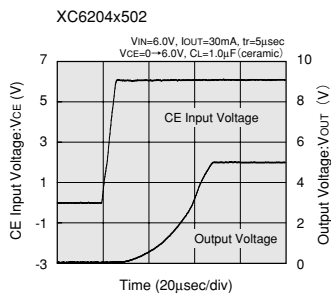
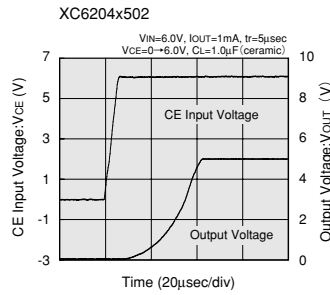
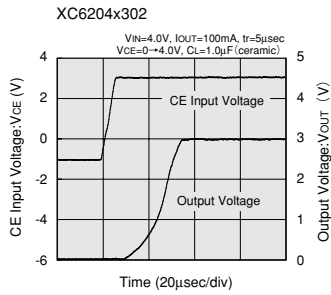
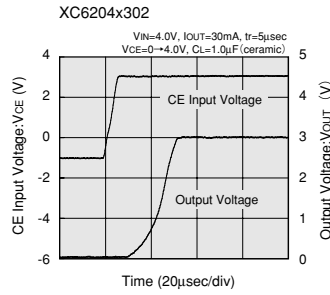
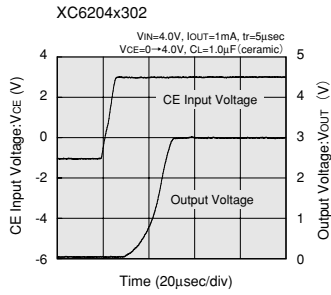

3

XC6204 Series

(12) RIPPLE REJECTION RATE

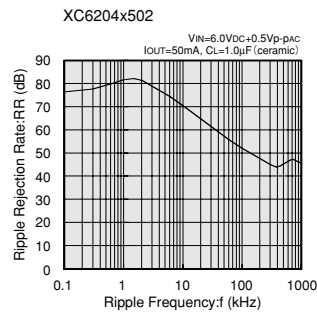
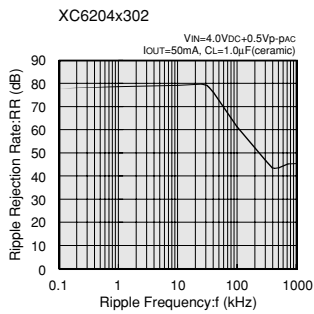
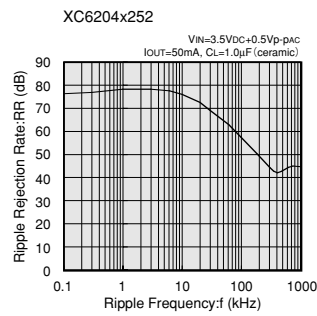
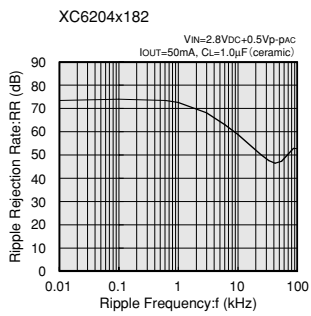

(13) OUTPUT NOISE DENSITY

