

**Features**

- 50 MHz - 3 dB bandwidth,  $A_V = +2$
- Differential gain 0.03%
- Differential phase 0.05°
- Output short circuit current 800 mA
- Can drive six 75Ω double terminated cables ±11V
- Slew rate = 1000V/μs
- Wide supply voltage range ±5V to ±15V

**Applications**

- Video line driver
- ATE pin driver
- High speed data acquisition

**Ordering Information**

Part No.	Temp. Range	Pkg.	Outline #
EL2099CT	0°C to +75°C	5-Pin TO-220	MDP0028

**General Description**

The EL2099C is a high speed, monolithic operational amplifier\* featuring excellent video performance and high output current capability. Built using Elantec's Complementary Bipolar process, the EL2099C uses current mode feedback to achieve wide bandwidth, and is stable in unity gain configuration.

Operation from power supplies ranging from ±5V to ±15V makes the EL2099C extremely versatile. With supplies at ±15V, the EL2099C can deliver ±11V into 25Ω at slew rates of 1000V/μs. At ±5V supplies, output voltage range is ±3V into 25Ω. Its speed and output current capability make this device ideal for video line driver and automatic test equipment applications.

Differential Gain and Phase of the EL2099C are 0.03% and 0.05° respectively, and - 3 dB bandwidth is 50 MHz. These features make the EL2099C especially well suited for video distribution applications.

Elantec products and facilities comply with MIL-I-45208A, and other applicable quality specifications. For information on Elantec's processing, see Elantec document, QRA-1: *Elantec's Processing, Monolithic Integrated Circuits.*

**Connection Diagram**

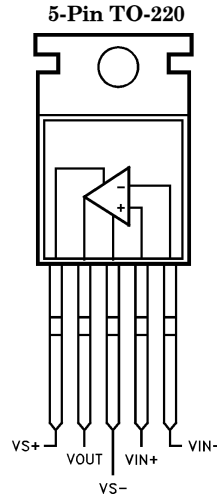

Manufactured under U.S. Patent Nos. 5,179,355, 4,893,091, U.K. Patent No. 2261786.

Note: All information contained in this data sheet has been carefully checked and is believed to be accurate as of the date of publication; however, this data sheet cannot be a "controlled document". Current revisions, if any, to these specifications are maintained at the factory and are available upon your request. We recommend checking the revision level before finalization of your design documentation.

# EL2099C

## Video Distribution Amplifier

### Absolute Maximum Ratings ( $T_A = 25^\circ\text{C}$ )

Voltage between $V_{S+}$ and $V_{S-}$	+33V	Internal Power Dissipation	See Curves
Voltage at $V_{S+}$	+16.5V	Operating Ambient Temperature Range	$0^\circ\text{C}$ to $+75^\circ\text{C}$
Voltage at $V_{S-}$	-16.5V	Operating Junction Temperature	$150^\circ\text{C}$
Voltage between $V_{IN+}$ and $V_{IN-}$	$\pm 6\text{V}$	Storage Temperature Range	$-65^\circ\text{C}$ to $+150^\circ\text{C}$
Current into $V_{IN+}$ or $V_{IN-}$	$\pm 10\text{mA}$		

#### Important Note:

All parameters having Min/Max specifications are guaranteed. The Test Level column indicates the specific device testing actually performed during production and Quality inspection. Elantec performs most electrical tests using modern high-speed automatic test equipment, specifically the LTX77 Series system. Unless otherwise noted, all tests are pulsed tests, therefore  $T_J = T_C = T_A$ .

Test Level	Test Procedure
I	100% production tested and QA sample tested per QA test plan QCX0002.
II	100% production tested at $T_A = 25^\circ\text{C}$ and QA sample tested at $T_A = 25^\circ\text{C}$ , $T_{MAX}$ and $T_{MIN}$ per QA test plan QCX0002.
III	QA sample tested per QA test plan QCX0002.
IV	Parameter is guaranteed (but not tested) by Design and Characterization Data.
V	Parameter is typical value at $T_A = 25^\circ\text{C}$ for information purposes only.

### Open Loop DC Electrical Characteristics

$V_S = \pm 15\text{V}$ ,  $R_L = 25\Omega$ ,  $T_A = 25^\circ\text{C}$  unless otherwise specified

Parameter	Description	Temp	Min	Typ	Max	Test Level	Units
$V_{OS}$	Input Offset Voltage	$25^\circ\text{C}$		5	20	I	mV
		$T_{MIN}, T_{MAX}$			25	IV	mV
$TC V_{OS}$	Average Offset Voltage Drift	Full		20		V	$\mu\text{V}/^\circ\text{C}$
$+I_{IN}$	+ Input Current	$25^\circ\text{C}$		5	20	I	$\mu\text{A}$
		$T_{MIN}, T_{MAX}$			30	IV	$\mu\text{A}$
$-I_{IN}$	- Input Current	$25^\circ\text{C}$		8	35	I	$\mu\text{A}$
		$T_{MIN}, T_{MAX}$			50	IV	$\mu\text{A}$
CMRR	Common Mode Rejection Ratio (Note 1)	$25^\circ\text{C}$	50	60		I	dB
PSRR	Power Supply Rejection Ratio (Note 2)	$25^\circ\text{C}$	60	70		I	dB
$R_{OL}$	Transimpedance	$25^\circ\text{C}$	85	140		I	$\text{k}\Omega$
$+R_{IN}$	+ Input Resistance (Note 3)	$25^\circ\text{C}$	700	1000		I	$\text{k}\Omega$
		$T_{MIN}, T_{MAX}$	600			IV	$\text{k}\Omega$
$+C_{IN}$	+ Input Capacitance	$25^\circ\text{C}$		3		V	pF
CMIR	Common Mode Input Range	$25^\circ\text{C}$		$\pm 12.5$		V	V

# EL2099C

## Video Distribution Amplifier

### Open Loop DC Electrical Characteristics — Contd.

$V_S = \pm 15V$ ,  $R_L = 25\Omega$ ,  $T_A = 25^\circ C$  unless otherwise specified

Parameter	Description	Temp	Min	Typ	Max	Test Level	Units
$V_O$	Output Voltage Swing $V_S = \pm 15V$	25°C	±9	±11		I	V
	Output Voltage Swing $V_S = \pm 5V$	25°C	±2.4	±3.0		I	V
$I_{OUT}$	Output Current	25°C	360	440		I	mA
$I_{SC}$	Output Short-Circuit Current	25°C	600	800		I	mA
		$T_{MIN}, T_{MAX}$		800		V	mA
$I_S$	Supply Current	25°C		32	45	I	mA

### Closed Loop AC Electrical Characteristics

$V_S = \pm 15V$ ,  $A_V = +2$ ,  $R_F = 510\Omega$ ,  $R_L = 25\Omega$ ,  $T_A = 25^\circ C$  unless otherwise specified

Parameter	Description	Min	Typ	Max	Test Level	Units
SR	Slew Rate (Notes 4, 7)	500	1000		IV	V/ $\mu s$
BW	-3 dB Bandwidth (Note 7)		50		V	MHz
Peaking	(Note 7)		0.3		V	dB
$t_r, t_f$	Rise Time, Fall Time (Notes 5, 7)		7		V	ns
dG	Differential Gain; DC Input Offset from 0V through +0.714V, AC Amplitude 286 mV <sub>p-p</sub> , $f = 3.58$ MHz (Notes 6, 7)		0.03		V	%
dP	Differential Phase; DC Input Offset from 0V through +0.714V, AC Amplitude 286 mV <sub>p-p</sub> , $f = 3.58$ MHz (Notes 6, 7)		0.05		V	deg. (°)

Note 1: The input is moved from -10V to +10V.

Note 2: The supplies are moved from ±5V to ±15V.

Note 3:  $V_{IN} = \pm 5V$ . See typical performance curve for larger values of  $V_{IN}$ .

Note 4: Slew Rate is with  $V_{OUT}$  from +5V to -5V and measured at 20% and 80%.

Note 5: Rise and Fall Times are with  $V_{OUT}$  between -0.5V and +0.5V and measured at 10% and 90%.

Note 6: See typical performance curves for other conditions.

Note 7: All AC tests are performed on a "warmed up" part, except for Slew Rate, which is pulse tested.

# EL2099C

## Video Distribution Amplifier

**Typical Performance Curves** ( $T_A = 25^\circ\text{C}$ ,  $R_L = 25\Omega$ ,  $A_V = +2$ ,  $R_F = 510$  unless otherwise specified)

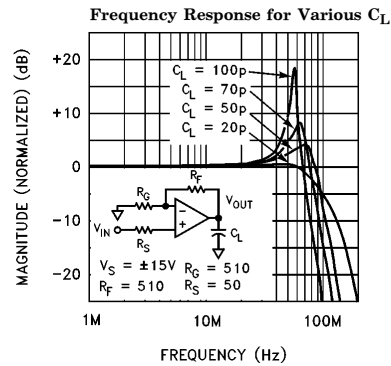
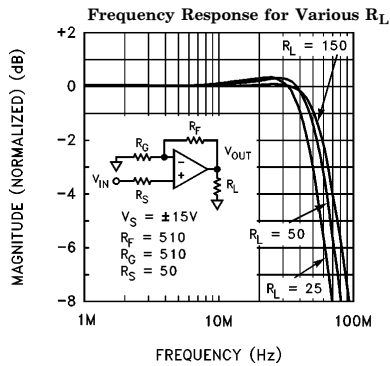
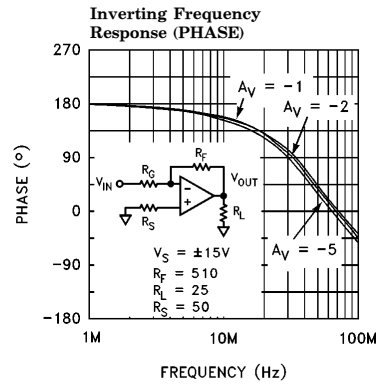
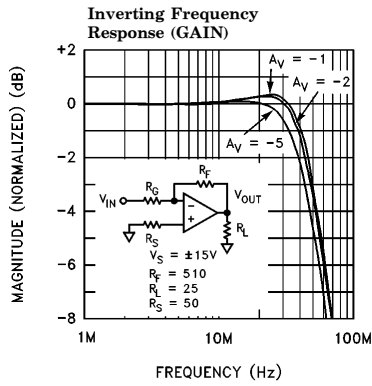
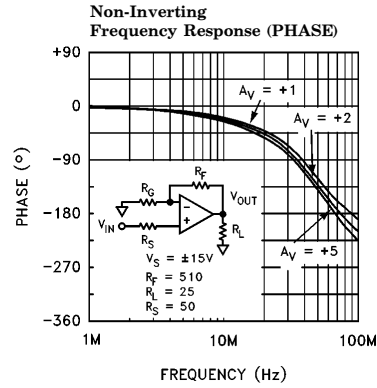
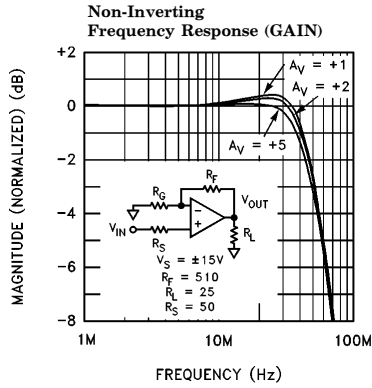

2099-2

# EL2099C

## Video Distribution Amplifier

### Typical Performance Curves

( $T_A = 25^\circ\text{C}$ ,  $R_L = 25\Omega$ ,  $A_V = +2$ ,  $R_F = 510$  unless otherwise specified) — Contd.

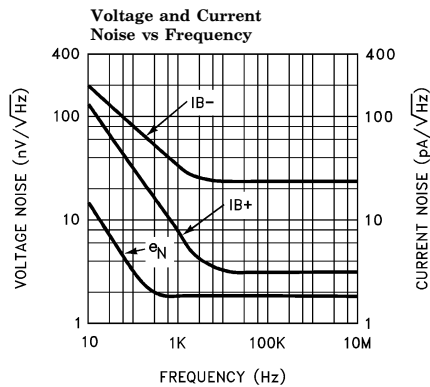
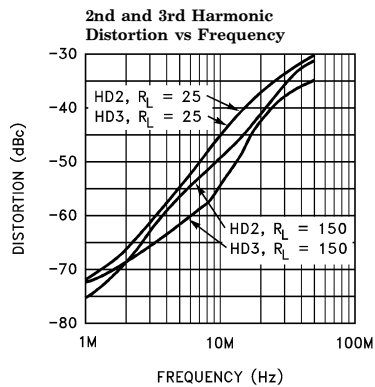
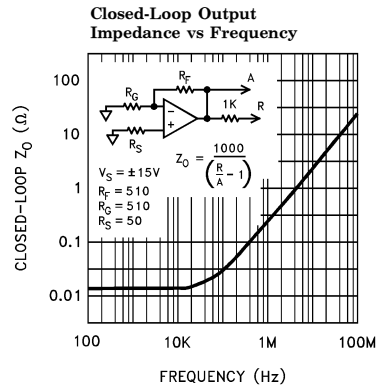
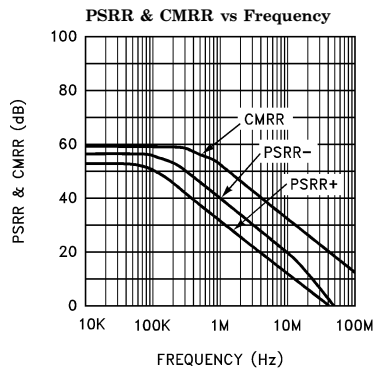
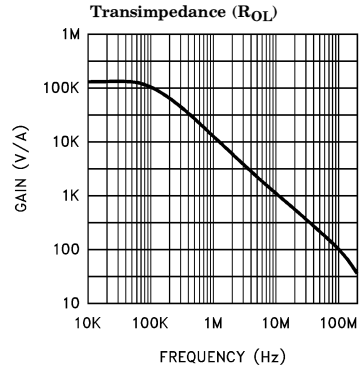
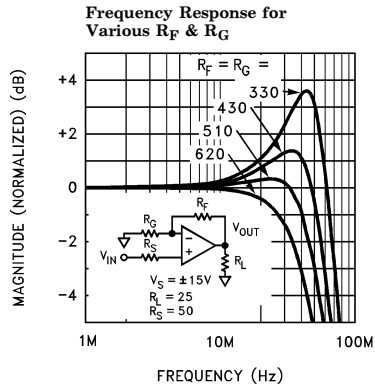

2099-3

# EL2099C

## Video Distribution Amplifier

### Typical Performance Curves

( $T_A = 25^\circ\text{C}$ ,  $R_L = 25\Omega$ ,  $A_V = +2$ ,  $R_F = 510$  unless otherwise specified) — Contd.

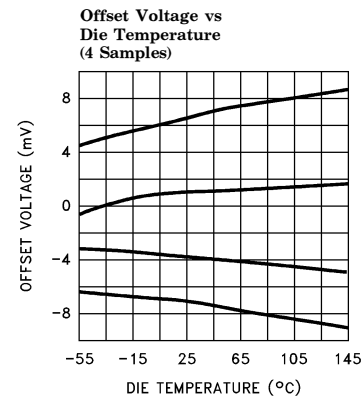
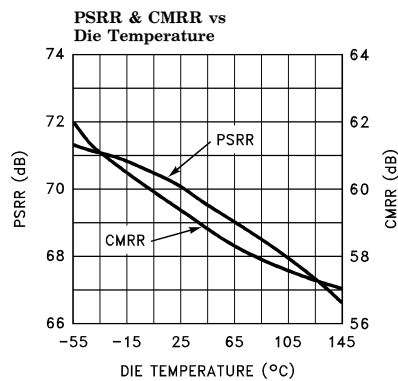
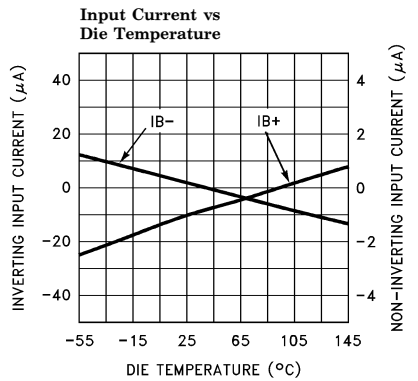
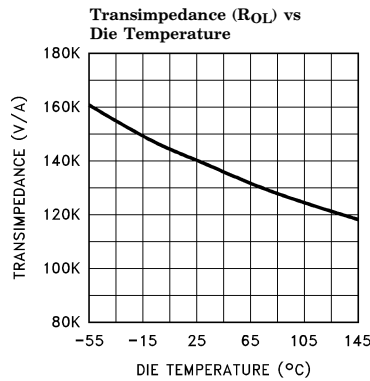
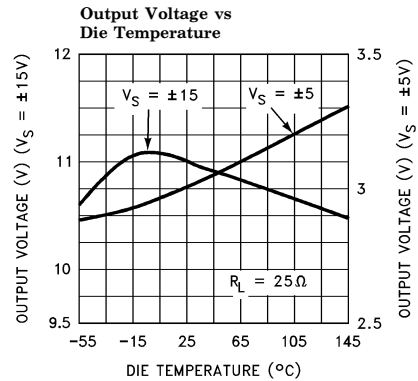
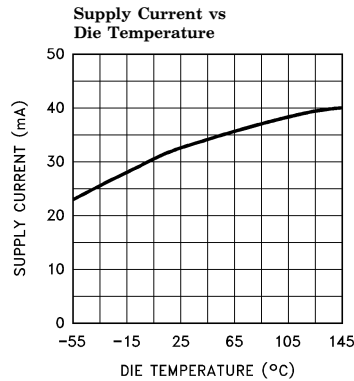

2099-4

# EL2099C

## Video Distribution Amplifier

### Typical Performance Curves

( $T_A = 25^\circ\text{C}$ ,  $R_L = 25\Omega$ ,  $A_V = +2$ ,  $R_F = 510$  unless otherwise specified) — Contd.

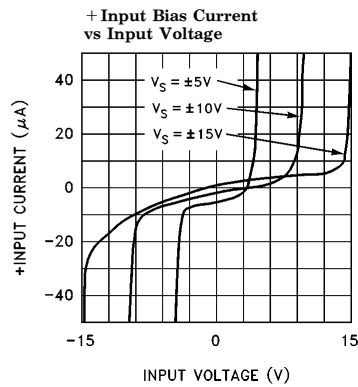
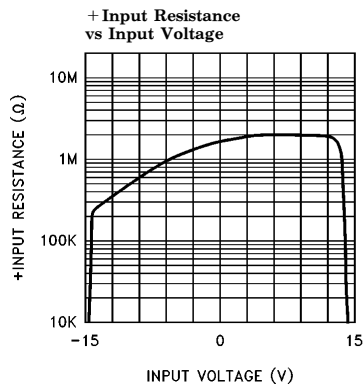
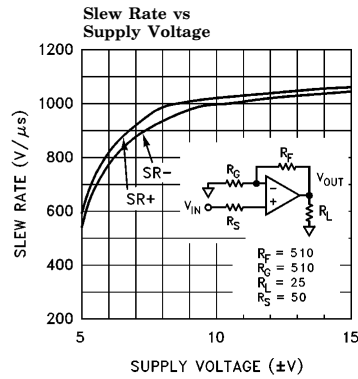
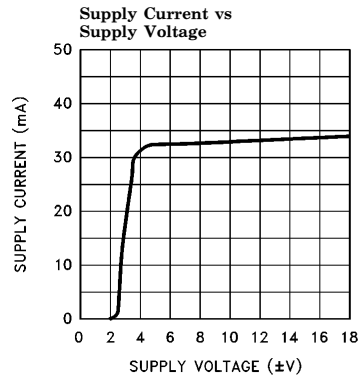
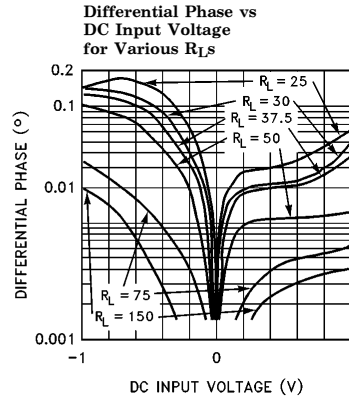
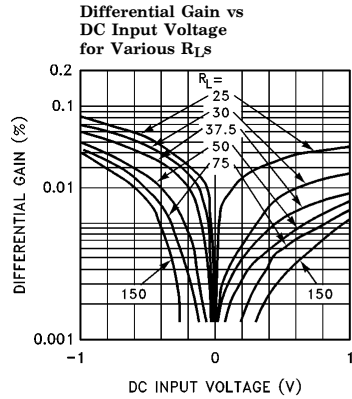

2099-5

# EL2099C

## Video Distribution Amplifier

### Typical Performance Curves

( $T_A = 25^\circ\text{C}$ ,  $R_L = 25\Omega$ ,  $A_V = +2$ ,  $R_F = 510$  unless otherwise specified) — Contd.

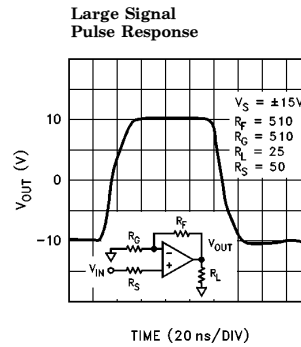
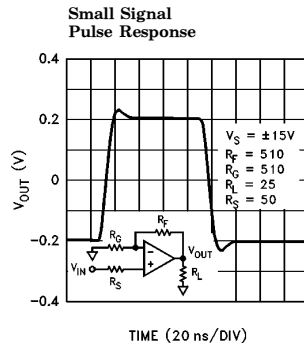
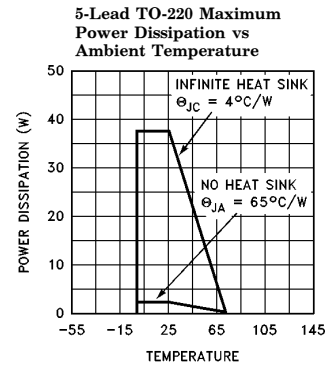
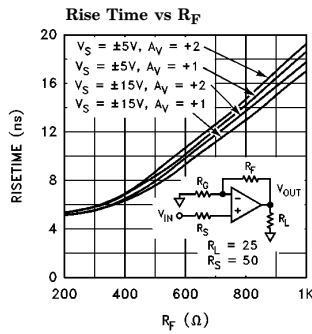
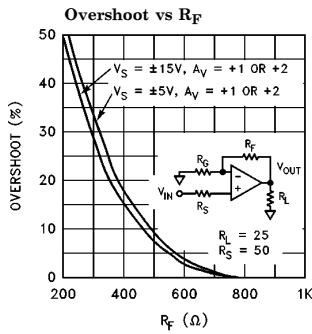
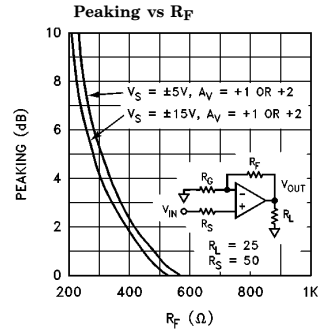
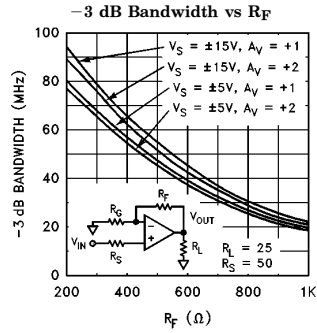

2099-6



# EL2099C

## Video Distribution Amplifier

### Simplified Schematic

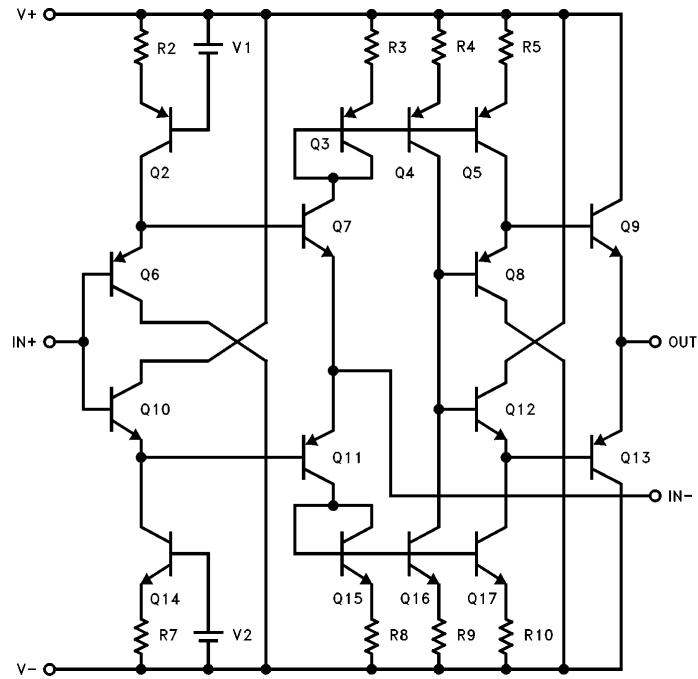

2099-7

### Burn-In Circuit

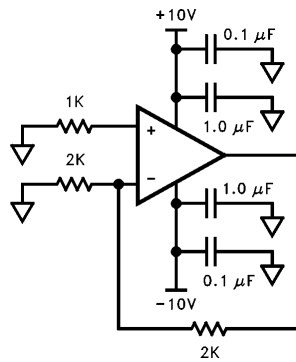

2099-8

# EL2099C

## Video Distribution Amplifier

### Applications Information

#### Product Description

The EL2099C is a current mode feedback amplifier that has high output current drive capability. It is built using Elantec's proprietary dielectric isolation process that produces NPN and PNP complimentary transistors. The high output current can be useful to drive many standard video loads in parallel, as well as digital sync pulses that are 8V or greater.

#### + Input Resistor Value

A small value resistor located in the + Input lead is necessary to keep the EL2099C from oscillating under certain conditions. A  $50\Omega$  resistor is recommended for all applications, although smaller values will work under some circumstances. All tests listed in this datasheet are performed with  $50\Omega$  in the + Input lead, as well as all typical performance curves. The  $50\Omega$  resistor along with the + Input bias current creates an additional typical Offset Voltage of only  $250\mu\text{V}$  at  $T = 25^\circ\text{C}$ , and a maximum of  $1.25\text{mV}$  over temperature variations.

#### Feedback Resistor Values

The EL2099C has been designed and specified with  $R_F = 510\Omega$  and  $A_V = +2$ . This value of feedback resistor yields extremely flat frequency response with little to no peaking. However, 3 dB bandwidth is reduced somewhat because of this. Wider bandwidth, at the expense of slight peaking, can be accomplished by reducing the value of the feedback resistor. For example, at a gain of +2, reducing the feedback resistor to  $330\Omega$  increases the -3 dB bandwidth to 70 MHz with 3 dB of peaking. Inversely, larger values of feedback resistor will cause roll off to occur at a lower frequency. There is essentially no peaking with  $R_F > 510\Omega$ .

#### Power Supplies

The EL2099C may be operated with single or split supplies as low as  $\pm 5\text{V}$  (10V total) to as high as  $\pm 18\text{V}$  (36V total). Bandwidth and slew rate are almost constant from  $V_S = \pm 10\text{V}$  to

$\pm 18\text{V}$ , and decrease slightly as supplies are reduced to  $\pm 5\text{V}$ , as shown in the characteristic curves. It is not necessary to use equal value split supplies. For example,  $-5\text{V}$  and  $-12\text{V}$  would be fine for 0V to 1V video signals.

Good power supply bypassing should be used to reduce the risk of oscillation. A  $1\mu\text{F}$  to  $10\mu\text{F}$  tantalum capacitor in parallel with a  $0.1\mu\text{F}$  ceramic capacitor is recommended for bypassing each supply pin. They should be kept as close as possible to the device pins.

Due to the internal construction of the TO-220 package, the tab of the EL2099C is connected to the  $V_{S-}$  pin. Therefore, care must be taken to avoid connecting the tab to the ground plane of the system.

#### Printed Circuit Board Layout

As with any high frequency device, good printed circuit board layout is necessary for optimum performance. Ground plane construction is highly recommended. Lead lengths should be as short as possible. For good AC performance, parasitic capacitances should be kept to a minimum, especially at the inverting input, which is sensitive to stray capacitance. This implies keeping the ground plane away from this pin. Metal film and carbon resistors are both acceptable, while use of wire-wound resistors is not recommended because of their parasitic inductance. Similarly, capacitors should be low inductance for best performance.

#### Driving Cables and Capacitive Loads

The EL2099C was designed with driving multiple coaxial cables in mind. With 440 mA of output drive and low output impedance, driving six  $75\Omega$  double terminated coaxial cables to  $\pm 11\text{V}$  with one EL2099C is practical.

When used as a cable driver, double termination is always recommended for reflection-free performance. For those applications, the back termination series resistor will decouple the EL2099C from the capacitive cable and allow extensive capacitive drive. For a discussion on some of the other ways to drive cables, see the application section on driving cables in the EL2003 data sheet.

# EL2099C

## Video Distribution Amplifier

### Applications Information — Contd.

Other applications may have high capacitive loads without termination resistors. In these applications, an additional small value ( $5\Omega$ – $50\Omega$ ) resistor in series with the output will eliminate most peaking.

The schematic below shows the EL2099C driving 6 double terminated cables, each of average length of 50 feet.

This represents driving an effective load of  $25\Omega$  to over  $\pm 10V$ . The resulting performance is shown in the scope photo. Notice that double termination results in reflection free performance.

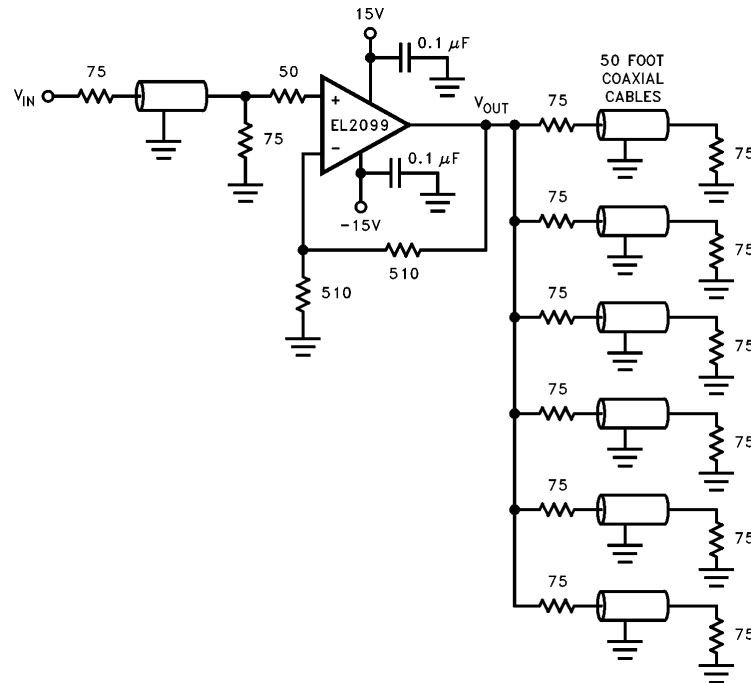

2099-10

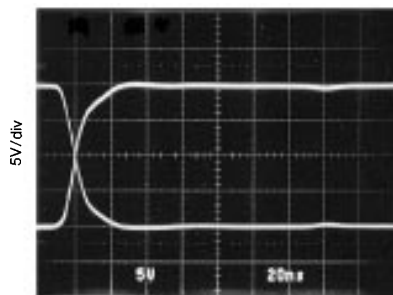

20 ns/div

2099-11

# EL2099C

## Video Distribution Amplifier

### EL2099 Macromodel

```

* Connections:
*           + input
*           |
*           | - input
*           |
*           | + Vsupply
*           | - Vsupply
*           |
*           | output
*           |
.subckt M2099 4 5 1 3 2
*
* Input Stage
*
e1 10 0 4 0 1.0
vis 10 9 0V
h2 9 12 vxx 1.0
r1 5 11 50
l1 11 12 48nH
iinp 4 0 5μA
iinm 5 0 -8μA
*
* Slew Rate Limiting
*
h1 13 0 vis 600
r2 13 14 1K
d1 14 0 dclamp
d2 0 14 dclamp
*
* High Frequency Pole
*
*e2 30 0 14 0 0.001667
l3 30 17 1.5μH
c5 17 0 1pF
r5 17 0 500
*
* Transimpedance Stage
*
g1 0 18 17 0 1.0
ro1 18 0 150K
cdp 18 0 8pF
*
* Output Stage
*
q1 3 18 19 qp
q2 1 18 20 qn
q3 1 19 21 qn
q4 3 20 22 qp
r7 21 2 1
r8 22 2 1

```

# ***EL2099C***

## *Video Distribution Amplifier*

### **EL2099 Macromodel — Contd.**

```
ios1 1 19 5mA
ios2 20 3 5mA
*
* Supply Current
*
ips 1 3 19mA
*
* Error Terms
*
ivos 0 23 5mA
vxx 23 0 0V
e4 24 0 2 0 1.0
e5 25 0 1 0 1.0
e6 26 0 3 0 1.0
r9 24 23 3K
r10 25 23 1K
r11 26 23 1K

* Models
*
.model qn npn (is = 5e-15 bf = 200 tf = 0.1nS)
.model qp pnp (is = 5e-15 bf = 200 tf = 0.1nS)
.model dclamp d (is = 1e-30 ibv = 0.266 bv = 5 n = 4)
.ends
```

# EL2099C

## Video Distribution Amplifier

### EL2099 Macromodel — Contd.

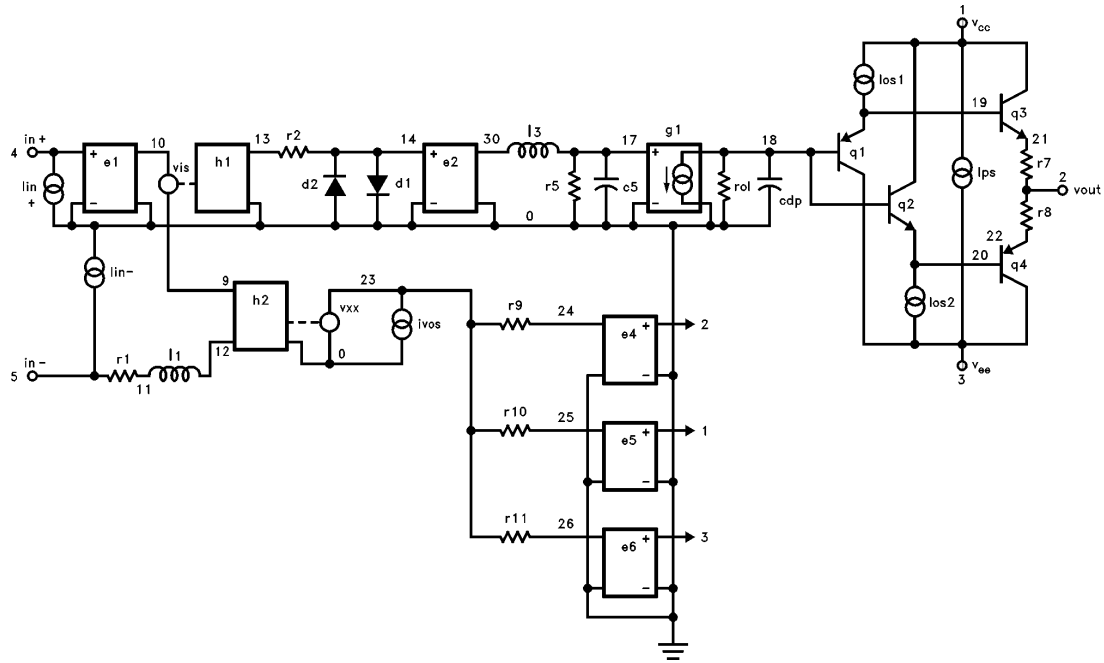

2099-9

**BLANK**

# ***EL2099C***

## ***Video Distribution Amplifier***

### **General Disclaimer**

Specifications contained in this data sheet are in effect as of the publication date shown. Elantec, Inc. reserves the right to make changes in the circuitry or specifications contained herein at any time without notice. Elantec, Inc. assumes no responsibility for the use of any circuits described herein and makes no representations that they are free from patent infringement.

***élantec***  
HIGH PERFORMANCE ANALOG INTEGRATED CIRCUITS

**Elantec, Inc.**  
1996 Tarob Court  
Milpitas, CA 95035  
Telephone: (408) 945-1323  
(800) 333-6314  
Fax: (408) 945-9305  
European Office: 44-71-482-4596

### **WARNING — Life Support Policy**

Elantec, Inc. products are not authorized for and should not be used within Life Support Systems without the specific written consent of Elantec, Inc. Life Support systems are equipment intended to support or sustain life and whose failure to perform when properly used in accordance with instructions provided can be reasonably expected to result in significant personal injury or death. Users contemplating application of Elantec, Inc. products in Life Support Systems are requested to contact Elantec, Inc. factory headquarters to establish suitable terms & conditions for these applications. Elantec, Inc.'s warranty is limited to replacement of defective components and does not cover injury to persons or property or other consequential damages.