

250MHz/3mA Current Mode Feedback Amplifiers

élantec

The EL2180, EL2280, and EL2480 are single, dual, and quad current-feedback operational amplifiers which achieve a -3dB bandwidth of 250MHz at a gain of +1 while consuming only 3mA of supply current per amplifier. They will operate with dual supplies ranging from $\pm 1.5V$ to $\pm 6V$, or from single supplies ranging from +3V to +12V. In spite of their low supply current, the EL2480 and the EL2280 can output 55mA while swinging to $\pm 4V$ on $\pm 5V$ supplies. The EL2180 can output 100mA with similar output swings. These attributes make the EL2180, EL2280, and EL2480 excellent choices for low power and/or low voltage cable-driver, HDSL, or RGB applications.

For applications where board space is extremely critical, the EL2180 is available in the tiny 5-pin SOT-23 package, which has a footprint 28% the size of an 8-pin SO.

For single, dual, and triple applications with disable, consider the EL2186 (8-pin single), EL2286 (14-pin dual), or EL2386 (16-pin triple). For lower power applications where speed is still a concern, consider the EL2170/EL2176 family which also comes in similar single, dual, and quad configurations. The EL2170/EL2176 family provides a -3dB bandwidth of 70MHz while consuming 1mA of supply current per amplifier.

Ordering Information

PART NUMBER	PACKAGE	TAPE & REEL	PKG. NO.
EL2180CN	8-Pin PDIP	-	MDP0031
EL2180CS	8-Pin SO	-	MDP0027
EL2180CS-T7	8-Pin SO	7"	MDP0027
EL2180CS-T13	8-Pin SO	13"	MDP0027
EL2180CW-T7	5-Pin SOT-23*	7"	MDP0038
EL2180CW-T13	5-Pin SOT-23*	13"	MDP0038
EL2280CN	8-Pin PDIP	-	MDP0031
EL2280CS	8-Pin SO	-	MDP0027
EL2280CS-T7	8-Pin SO	7"	MDP0027
EL2280CS-T13	8-Pin SO	13"	MDP0027
EL2480CN	14-Pin PDIP	-	MDP0031
EL2480CS	14-Pin SO	-	MDP0027
EL2480CS-T7	14-Pin SO	7"	MDP0027
EL2480CS-T13	14-Pin SO	13"	MDP0027

NOTE:

*EL2180CW symbol is .Cxxx where xxx represents date code

Features

- Single (EL2180), dual (EL2280), and quad (EL2480) topologies
- 3mA supply current (per amplifier)
- 250MHz -3dB bandwidth
- Tiny SOT23-5 package (EL2180)
- Low cost
- Single- and dual-supply operation down to $\pm 1.5V$
- 0.05%/0.05° diff. gain/diff. phase into 150 Ω
- 1200V/ μ s slew rate
- Large output drive current - 100mA (EL2180), 55mA (EL2280), 55mA (EL2480)
- Also available with disable in single (EL2186), dual (EL2286), and triple (EL2386)
- Lower power EL2170/EL2176 family available (1mA/70MHz) in single, dual, and quad

Applications

- Low power/battery applications
- HDSL amplifiers
- Video amplifiers
- Cable drivers
- RGB amplifiers
- Test equipment amplifiers
- Current to voltage converters

Pinouts

EL2180
(8-PIN SO, PDIP)
TOP VIEW

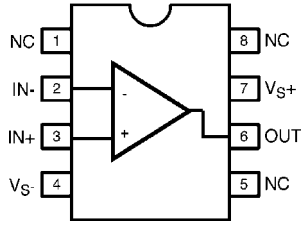

EL2280
(8-PIN SO, PDIP)
TOP VIEW

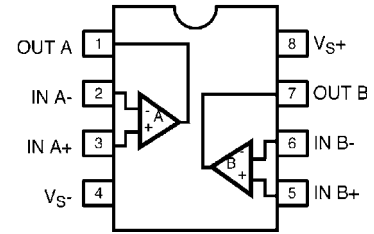

EL2180
(5-PIN SOT 23)
TOP VIEW

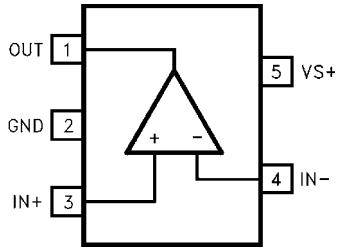

EL2480
(14-PIN SO, PDIP)
TOP VIEW

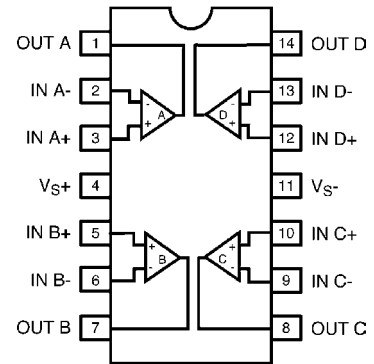

EL2180, EL2280, EL2480

Absolute Maximum Ratings ($T_A = 25^\circ\text{C}$)

Supply Voltage between V_{S+} and GND. +12.6V
 Voltage between V_{S+} and V_{S-} +12.6V
 Common-Mode Input Voltage V_{S-} to V_{S+}
 Differential Input Voltage $\pm 6\text{V}$
 Current into +IN or -IN $\pm 7.5\text{mA}$
 Internal Power Dissipation See Curves
 Operating Ambient Temperature Range -40°C to $+85^\circ\text{C}$

Operating Junction Temperature
 Plastic Packages 150°C
 Output Current (EL2180) $\pm 120\text{mA}$
 Output Current (EL2280) $\pm 60\text{mA}$
 Output Current (EL2480) $\pm 60\text{mA}$
 Storage Temperature Range -65°C to $+150^\circ\text{C}$

CAUTION: Stresses above those listed in "Absolute Maximum Ratings" may cause permanent damage to the device. This is a stress only rating and operation of the device at these or any other conditions above those indicated in the operational sections of this specification is not implied.

IMPORTANT NOTE: All parameters having Min/Max specifications are guaranteed. Typical values are for information purposes only. Unless otherwise noted, all tests are at the specified temperature and are pulsed tests, therefore: $T_J = T_C = T_A$

DC Electrical Specifications $V_S = \pm 5\text{V}$, $R_L = 150\Omega$, $T_A = 25^\circ\text{C}$ unless otherwise specified

PARAMETER	DESCRIPTION	CONDITIONS	MIN	TYP	MAX	UNIT
V_{OS}	Input Offset Voltage			2.5	10	mV
TCV_{OS}	Average Input Offset Voltage Drift	Measured from T_{MIN} to T_{MAX}		5		$\mu\text{V}/^\circ\text{C}$
dV_{OS}	V_{OS} Matching	EL2280, EL2480 only		0.5		mV
+ I_{IN}	+Input Current			1.5	15	μA
$d+I_{IN}$	+ I_{IN} Matching	EL2280, EL2480 only		20		nA
- I_{IN}	-Input Current			16	40	μA
$d-I_{IN}$	- I_{IN} Matching	EL2280, EL2480 only		2		μA
CMRR	Common Mode Rejection Ratio	$V_{CM} = \pm 3.5\text{V}$	45	50		dB
-ICMR	-Input Current Common Mode Rejection	$V_{CM} = \pm 3.5\text{V}$		5	30	$\mu\text{A}/\text{V}$
PSRR	Power Supply Rejection Ratio	V_S is moved from $\pm 4\text{V}$ to $\pm 6\text{V}$	60	70		dB
-IPSR	- Input Current Power Supply Rejection	V_S is moved from $\pm 4\text{V}$ to $\pm 6\text{V}$		1	15	$\mu\text{A}/\text{V}$
R_{OL}	Transimpedance	$V_{OUT} = \pm 2.5\text{V}$	120	300		$\text{k}\Omega$
+ R_{IN}	+Input Resistance	$V_{CM} = \pm 3.5\text{V}$	0.5	2		$\text{M}\Omega$
+ C_{IN}	+Input Capacitance			1.2		pF
CMIR	Common Mode Input Range		± 3.5	± 4.0		V
V_O	Output Voltage Swing	$V_S = \pm 5$	± 3.5	± 4.0		V
		$V_S = 5$ single-supply, high		4.0		V
		$V_S = 5$ single-supply, low		0.3		V
I_O	Output Current	EL2180 only	80	100		mA
		EL2280 only, per amplifier	50	55		mA
		EL2480 only, per amplifier	50	55		mA
I_S	Supply Current	Per amplifier		3	6	mA

EL2180, EL2280, EL2480

AC Electrical Specifications $V_S = \pm 5V$, $R_F = R_G = 750\Omega$ for PDIP and SO packages, $R_F = R_G = 560\Omega$ for SOT23-5 package,
 $R_L = 150\Omega$, $T_A = 25^\circ C$ unless otherwise specified

PARAMETER	DESCRIPTION	CONDITIONS	MIN	TYP	MAX	UNIT
-3dB BW	-3dB Bandwidth	$A_V = 1$		250		MHz
-3dB BW	-3dB Bandwidth	$A_V = 2$		180		MHz
0.1dB BW	0.1dB Bandwidth	$A_V = 2$		50		MHz
SR	Slew Rate	$V_{OUT} = \pm 2.5V$, $A_V = 2$	600	1200		V/ μ s
t_R , t_F	Rise and Fall Time	$V_{OUT} = \pm 500mV$		1.5		ns
t_{PD}	Propagation Delay	$V_{OUT} = \pm 500mV$		1.5		ns
OS	Overshoot	$V_{OUT} = \pm 500mV$		3.0		%
t_S	0.1% Settling	$V_{OUT} = \pm 2.5V$, $A_V = -1$		15		ns
dG	Differential Gain	$A_V = 2$, $R_L = 150\Omega$ (Note 1)		0.05		%
dP	Differential Phase	$A_V = 2$, $R_L = 150\Omega$ (Note 1)		0.05		°
dG	Differential Gain	$A_V = 1$, $R_L = 500\Omega$ (Note 1)		0.01		%
dP	Differential Phase	$A_V = 1$, $R_L = 500\Omega$ (Note 1)		0.01		°
C_S	Channel Separation	EL2280, EL2480 only, $f = 5MHz$		85		dB

NOTE:

1. DC offset from 0V to 0.714V, AC amplitude 286mV_{p-p}, $f = 3.58MHz$

Test Circuit (per Amplifier)

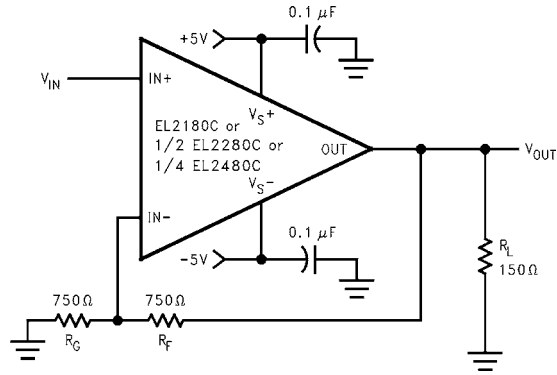

Simplified Schematic (per Amplifier)

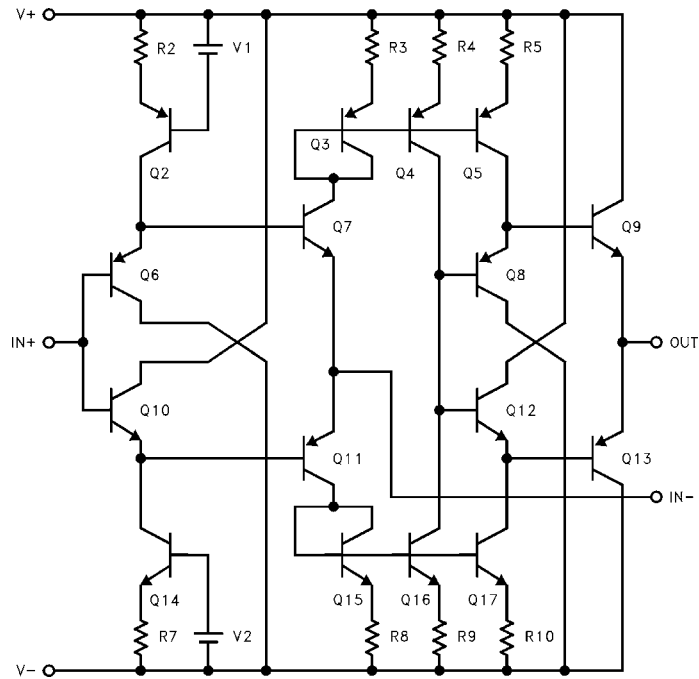

Typical Performance Curves

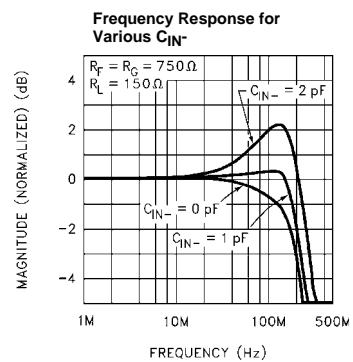
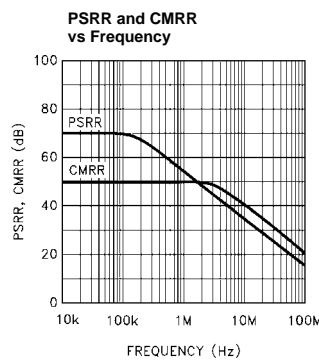
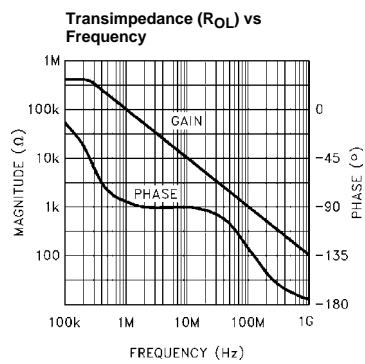
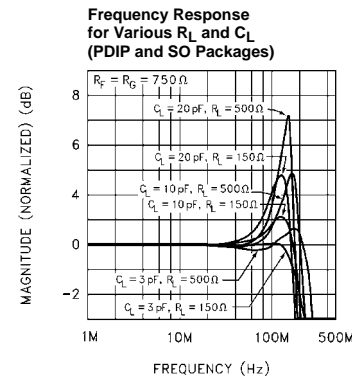
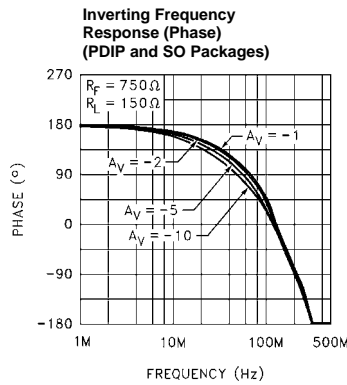
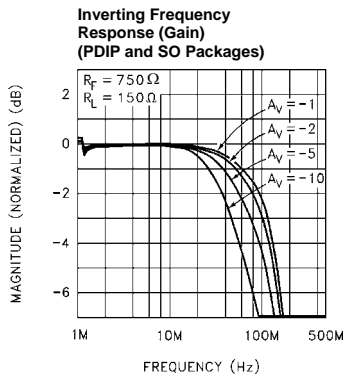
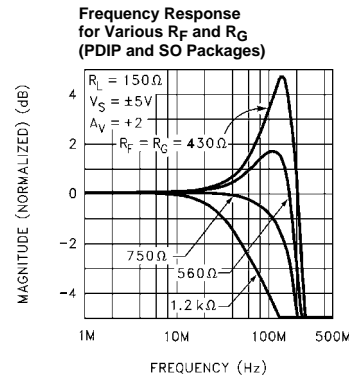
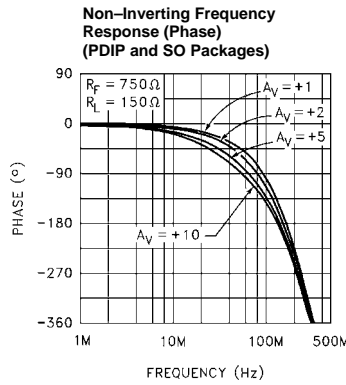
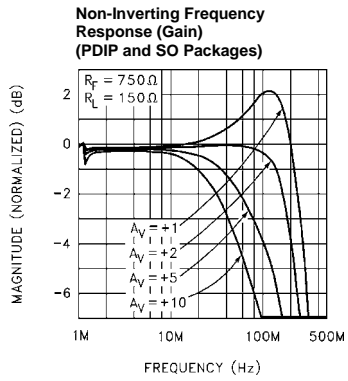

Typical Performance Curves (Continued)

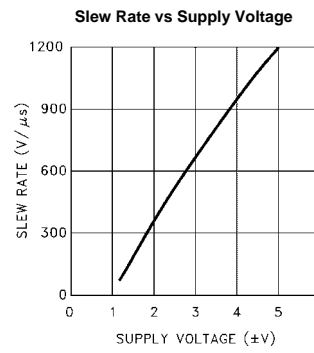
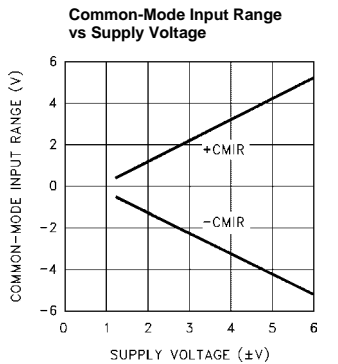
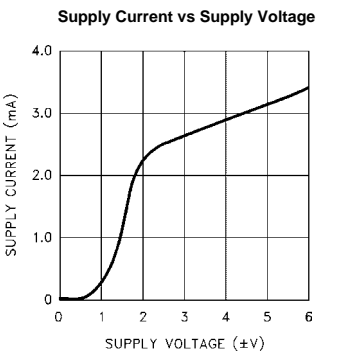
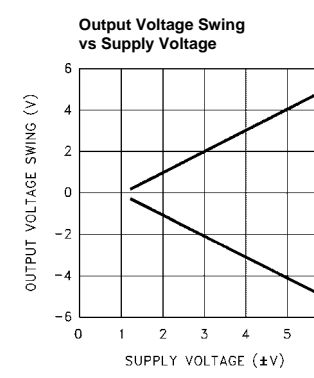
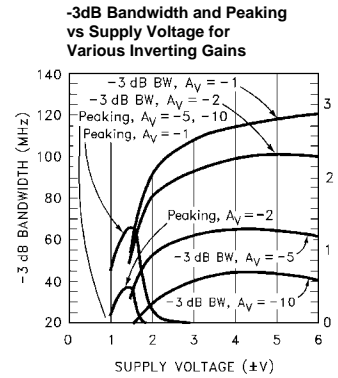
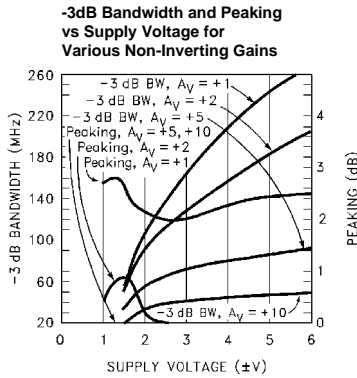
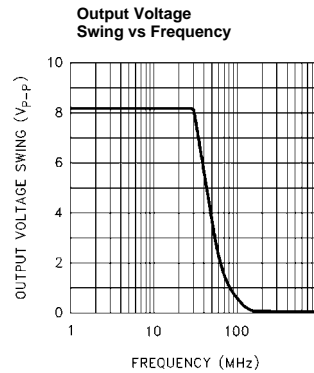
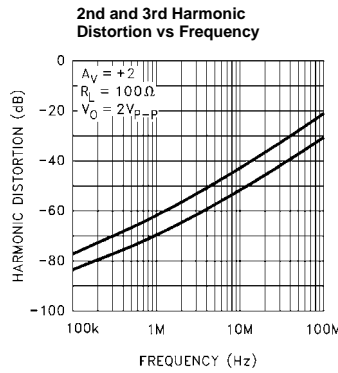
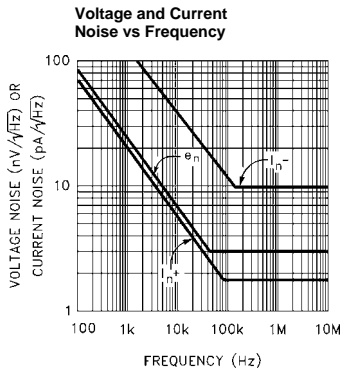

Typical Performance Curves (Continued)

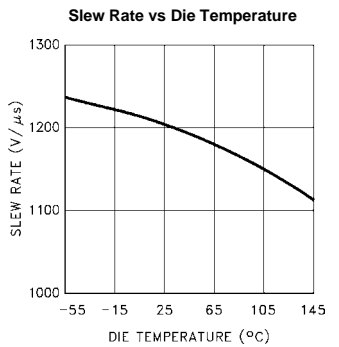
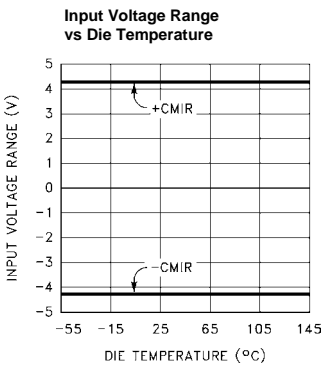
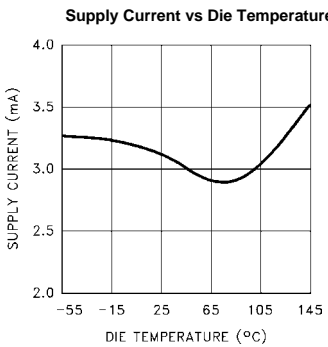
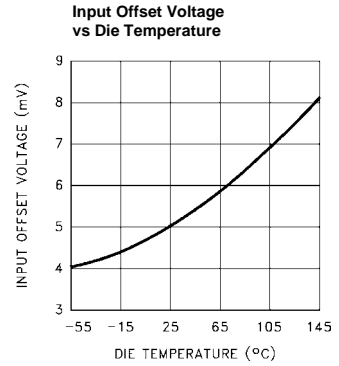
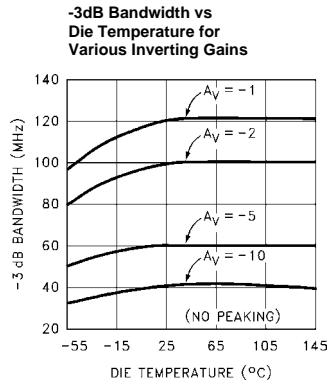
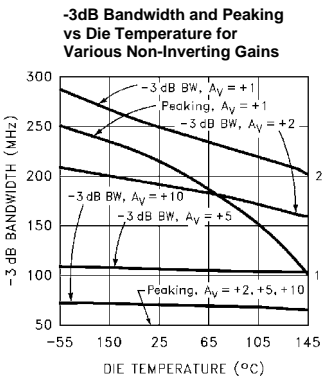
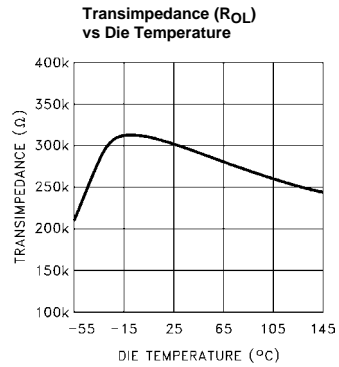
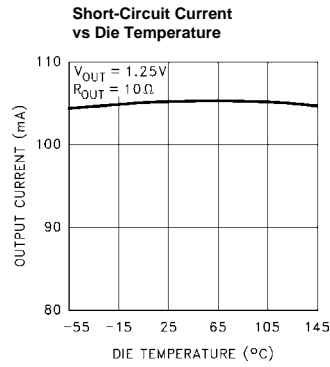
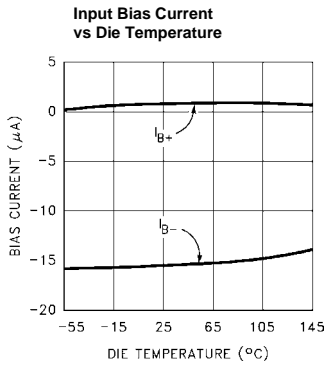

Typical Performance Curves (Continued)

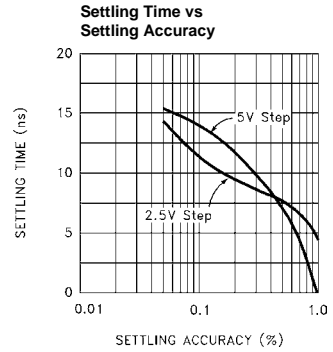
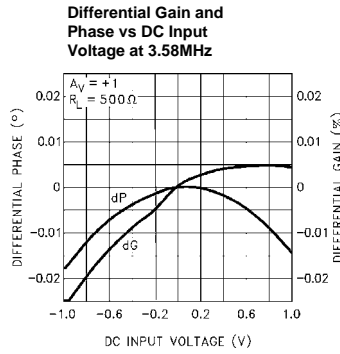
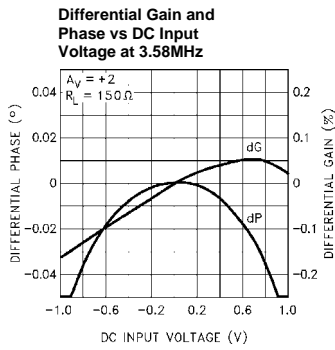

Small-Signal Step Response

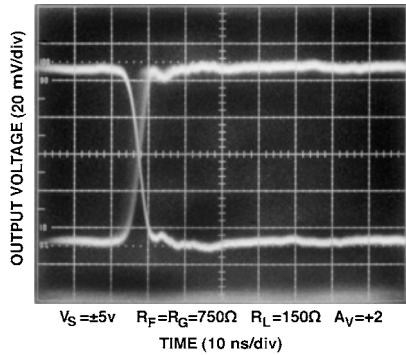

Large-Signal Step Response

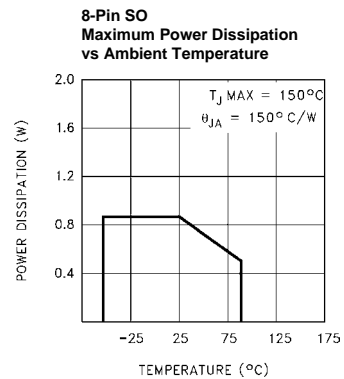
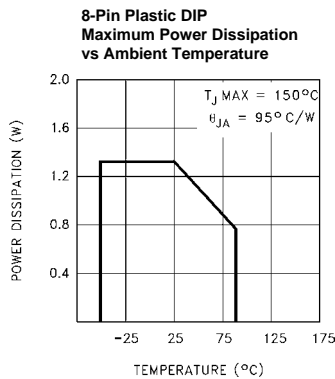
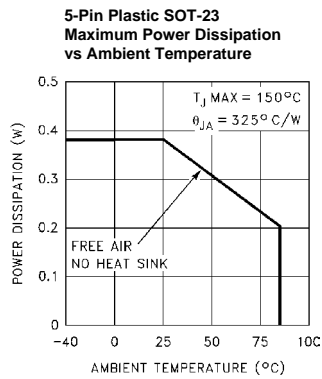
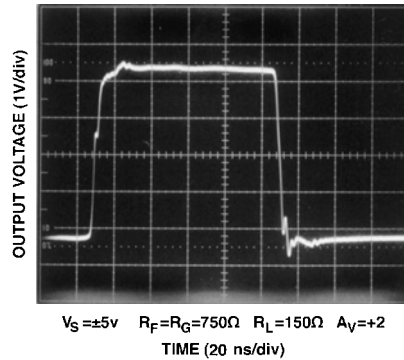

Typical Performance Curves (Continued)

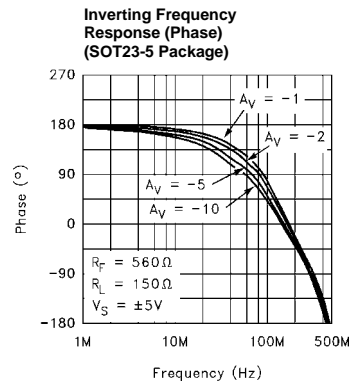
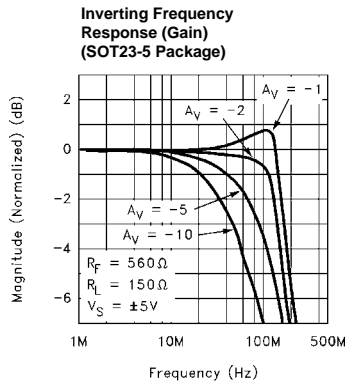
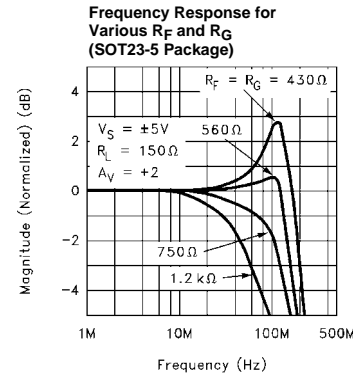
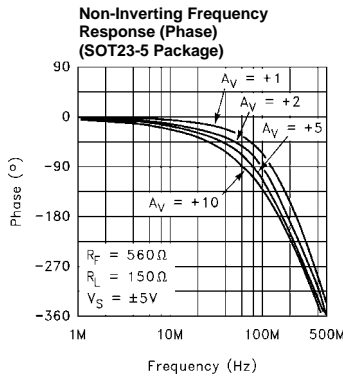
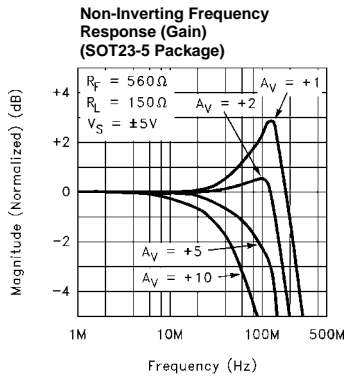
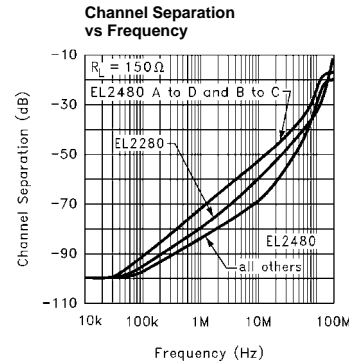
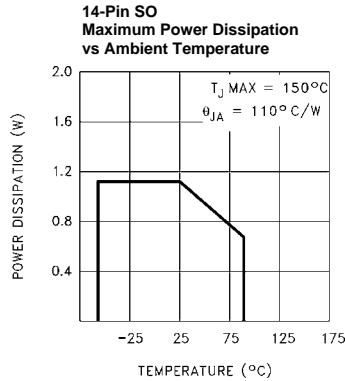
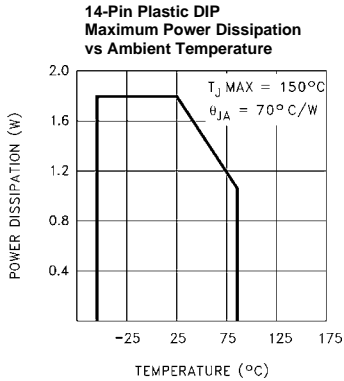

Applications Information

Product Description

The EL2180, EL2280, and EL2480 are current-feedback operational amplifiers that offer a wide -3dB bandwidth of 250MHz and a low supply current of 3mA per amplifier. All of these products also feature high output current drive. The EL2180 can output 100mA, while the EL2280 and the EL2480 can output 55mA per amplifier. The EL2180, EL2280, and EL2480 work with supply voltages ranging from a single 3V to $\pm 6V$, and they are also capable of swinging to within 1V of either supply on the input and the output. Because of their current-feedback topology, the EL2180, EL2280, and EL2480 do not have the normal gain-bandwidth product associated with voltage-feedback operational amplifiers. This allows their -3dB bandwidth to remain relatively constant as closed-loop gain is increased. This combination of high bandwidth and low power, together with aggressive pricing make the EL2180, EL2280, and EL2480 the ideal choice for many low-power/high-bandwidth applications such as portable computing, HDSL, and video processing.

For applications where board space is extremely critical, the EL2180 is available in the tiny 5-pin SOT-23 package, which has a footprint 28% the size of an 8-pin SO. The EL2180, EL2280, and EL2480 are each also available in industry standard pinouts in PDIP and SO packages.

For single, dual and triple applications with disable, consider the EL2186 (8-pin single), EL2286 (14-pin dual) and EL2386 (16-pin triple). If lower power is required, refer to the EL2170/EL2176 family which provides singles, duals, and quads with 70MHz of bandwidth while consuming 1mA of supply current per amplifier.

Power Supply Bypassing and Printed Circuit Board Layout

As with any high-frequency device, good printed circuit board layout is necessary for optimum performance. Ground plane construction is highly recommended. Lead lengths should be as short as possible. The power supply pins must be well bypassed to reduce the risk of oscillation. The combination of a 4.7 μ F tantalum capacitor in parallel with a 0.1 μ F capacitor has been shown to work well when placed at each supply pin.

For good AC performance, parasitic capacitance should be kept to a minimum especially at the inverting input (see the Capacitance at the Inverting Input section). Ground plane construction should be used, but it should be removed from the area near the inverting input to minimize any stray capacitance at that node. Carbon or Metal-Film resistors are acceptable with the Metal-Film resistors giving slightly less peaking and bandwidth because of their additional series inductance. Use of sockets, particularly for the SO package, should be avoided if possible. Sockets add parasitic

inductance and capacitance which will result in some additional peaking and overshoot.

Capacitance at the Inverting Input

Any manufacturer's high-speed voltage- or current-feedback amplifier can be affected by stray capacitance at the inverting input. For inverting gains this parasitic capacitance has little effect because the inverting input is a virtual ground, but for non-inverting gains this capacitance (in conjunction with the feedback and gain resistors) creates a pole in the feedback path of the amplifier. This pole, if low enough in frequency, has the same destabilizing effect as a zero in the forward open-loop response. The use of large value feedback and gain resistors further exacerbates the problem by further lowering the pole frequency.

The experienced user with a large amount of PC board layout experience may find in rare cases that the EL2180, EL2280, and EL2480 have less bandwidth than expected.

The reduction of feedback resistor values (or the addition of a very small amount of external capacitance at the inverting input, e.g. 0.5pF) will increase bandwidth as desired. Please see the curves for Frequency Response for Various R_F and R_G , and Frequency Response for Various C_{IN} .

Feedback Resistor Values

The EL2180, EL2280, and EL2480 have been designed and specified at gains of +1 and +2 with $R_F = 750\Omega$ in PDIP and SO packages and $R_F = 560\Omega$ in SOT23-5 package. These values of feedback resistors give 250MHz of -3dB bandwidth at $A_V = +1$ with about 2.5dB of peaking, and 180MHz of -3dB bandwidth at $A_V = +2$ with about 0.1dB of peaking. The SOT23-5 package is characterized with a smaller value of feedback resistor, for a given bandwidth, to compensate for lower parasitics within both the package itself and the printed circuit board where it will be placed. Since the EL2180, EL2280, and EL2480 are current-feedback amplifiers, it is also possible to change the value of R_F to get more bandwidth. As seen in the curve of Frequency Response For Various R_F and R_G , bandwidth and peaking can be easily modified by varying the value of the feedback resistor.

Because the EL2180, EL2280, and EL2480 are current-feedback amplifiers, their gain-bandwidth product is not a constant for different closed-loop gains. This feature actually allows the EL2180, EL2280, and EL2480 to maintain about the same -3dB bandwidth, regardless of closed-loop gain. However, as closed-loop gain is increased, bandwidth decreases slightly while stability increases. Since the loop stability is improving with higher closed-loop gains, it becomes possible to reduce the value of R_F below the specified 560 Ω and 750 Ω and still retain stability, resulting in only a slight loss of bandwidth with increased closed-loop gain.

Supply Voltage Range and Single-Supply Operation

The EL2180, EL2280, and EL2480 have been designed to operate with supply voltages having a span of greater than 3V, and less than 12V. In practical terms, this means that the EL2180, EL2280, and EL2480 will operate on dual supplies ranging from $\pm 1.5V$ to $\pm 6V$. With a single-supply, the EL2180, EL2280, and EL2480 will operate from +3V to +12V.

As supply voltages continue to decrease, it becomes necessary to provide input and output voltage ranges that can get as close as possible to the supply voltages. The EL2180, EL2280, and EL2480 have an input voltage range that extends to within 1V of either supply. So, for example, on a single +5V supply, the EL2180, EL2280, and EL2480 have an input range which spans from 1V to 4V. The output range of the EL2180, EL2280, and EL2480 is also quite large, extending to within 1V of the supply rail. On a $\pm 5V$ supply, the output is therefore capable of swinging from -4V to +4V. Single-supply output range is even larger because of the increased negative swing due to the external pull-down resistor to ground. On a single +5V supply, output voltage range is about 0.3V to 4V.

Video Performance

For good video performance, an amplifier is required to maintain the same output impedance and the same frequency response as DC levels are changed at the output. This is especially difficult when driving a standard video load of 150Ω , because of the change in output current with DC level. Until the EL2180, EL2280, and EL2480, good Differential Gain could only be achieved by running high idle currents through the output transistors (to reduce variations in output impedance). These currents were typically comparable to the entire 3mA supply current of each EL2180, EL2280, and EL2480 amplifier! Special circuitry has been incorporated in the EL2180, EL2280, and EL2480 to reduce the variation of output impedance with current output. This results in dG and dP specifications of 0.05% and 0.05° while driving 150Ω at a gain of +2.

Video performance has also been measured with a 500Ω load at a gain of +1. Under these conditions, the EL2180, EL2280, and EL2480 have dG and dP specifications of 0.01% and 0.01° respectively while driving 500Ω at $A_V = +1$.

Output Drive Capability

In spite of its low 3mA of supply current, the EL2180 is capable of providing a minimum of $\pm 80mA$ of output current. Similarly, each amplifier of the EL2280 and the EL2480 is capable of providing a minimum of $\pm 50mA$. These output drive levels are unprecedented in amplifiers running at these supply currents. With a minimum $\pm 80mA$ of output drive, the EL2180 is capable of driving 50Ω loads to $\pm 4V$, making it an excellent choice for driving isolation transformers in telecommunications applications. Similarly, the $\pm 50mA$

minimum output drive of each EL2280 and EL2480 amplifier allows swings of $\pm 2.5V$ into 50Ω loads.

Driving Cables and Capacitive Loads

When used as a cable driver, double termination is always recommended for reflection-free performance. For those applications, the back-termination series resistor will decouple the EL2180, EL2280, and EL2480 from the cable and allow extensive capacitive drive. However, other applications may have high capacitive loads without a back-termination resistor. In these applications, a small series resistor (usually between 5Ω and 50Ω) can be placed in series with the output to eliminate most peaking. The gain resistor (R_G) can then be chosen to make up for any gain loss which may be created by this additional resistor at the output. In many cases it is also possible to simply increase the value of the feedback resistor (R_F) to reduce the peaking.

Current Limiting

The EL2180, EL2280, and EL2480 have no internal current-limiting circuitry. If any output is shorted, it is possible to exceed the Absolute Maximum Ratings for output current or power dissipation, potentially resulting in the destruction of the device.

Power Dissipation

With the high output drive capability of the EL2180, EL2280, and EL2480, it is possible to exceed the $150^\circ C$ Absolute Maximum junction temperature under certain very high load current conditions. Generally speaking, when R_L falls below about 25Ω , it is important to calculate the maximum junction temperature (T_{JMAX}) for the application to determine if power-supply voltages, load conditions, or package type need to be modified for the EL2180, EL2280, and EL2480 to remain in the safe operating area. These parameters are calculated as follows [1]:

$$T_{JMAX} = T_{MAX} + (\theta_{JA} \times n \times PD_{MAX})$$

where:

T_{MAX} = Maximum ambient temperature

θ_{JA} = Thermal resistance of the package

n = Number of amplifiers in the package

PD_{MAX} = Maximum power dissipation of each amplifier in the package

PD_{MAX} for each amplifier can be calculated as follows [2]:

$$PD_{MAX} = (2 \times V_S \times I_{SMAX}) + (V_S - V_{OUTMAX}) \times \frac{V_{OUTMAX}}{R_L}$$

where:

V_S = Supply voltage

I_{SMAX} = Maximum supply current of 1 amplifier

V_{OUTMAX} = Maximum output voltage of the application

R_L = Load resistance

Typical Application Circuits

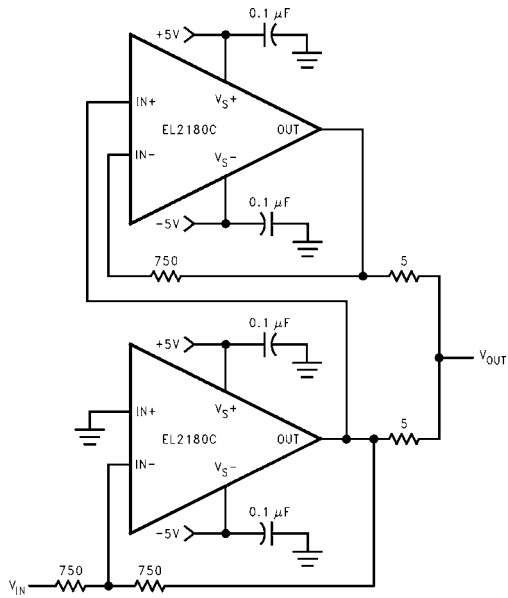

INVERTING 200mA OUTPUT CURRENT DISTRIBUTION AMPLIFIER

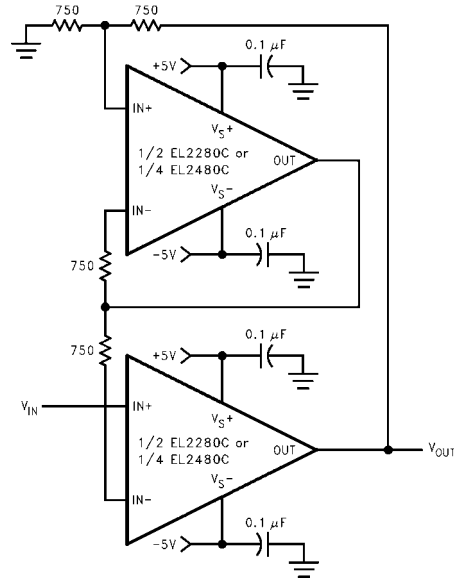

FAST-SETTLING PRECISION AMPLIFIER

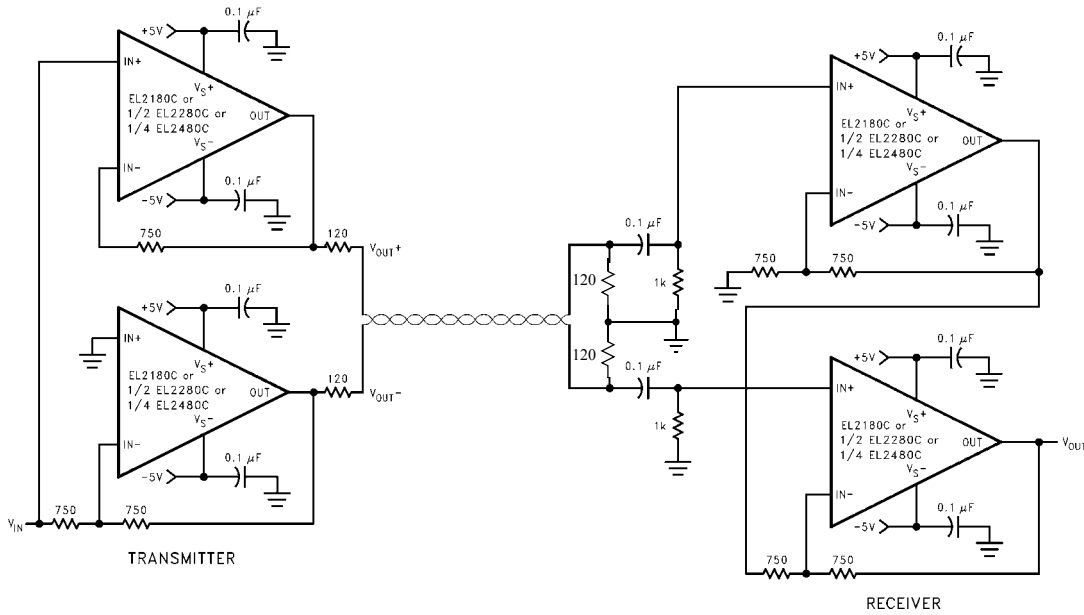

DIFFERENTIAL LINE-DRIVER/RECEIVER

EL2180/EL2280/EL2480 Macromodel

```

* EL2180 Macromodel
* Revision A, March 1995
* AC characteristics used: Rf = Rg = 750 ohms
* Connections:      +input
*                   |
*                   | -input
*                   | | +Vsupply
*                   | | | -Vsupply
*                   | | | | output
*                   | | | | |
.subckt EL2180/el 3 2 7 4 6
*
* Input Stage
*
e1 10 0 3 0 1.0
vis 10 9 0V
h2 9 12 vxx 1.0
r1 2 11 400
l1 11 12 25nH
iinp 3 0 1.5uA
iinm 2 0 3uA
r12 3 0 2Meg
*
* Slew Rate Limiting
*
h1 13 0 vis 600
r2 13 14 1K
d1 14 0 dclamp
d2 0 14 dclamp
*
* High Frequency Pole
*
e2 30 0 14 0 0.001666666666
l3 30 17 150nH
c5 17 0 0.8pF
r5 17 0 165
*
* Transimpedance Stage
*
g1 0 18 17 0 1.0
rol 18 0 450K
cdp 18 0 0.675pF
*
* Output Stage
*
q1 4 18 19 qp
q2 7 18 20 qn
q3 7 19 21 qn
q4 4 20 22 qp
r7 21 6 4
r8 22 6 4
ios1 7 19 1mA
ios2 20 4 1mA
*
* Supply Current
*
ips 7 4 0.2mA
*
* Error Terms
*

```

```

ivos 0 23 0.2mA
vxx 23 0 0V
e4 24 0 3 0 1.0
e5 25 0 7 0 1.0
e6 26 0 4 0 -1.0
r9 24 23 316
r10 25 23 3.2K
r11 26 23 3.2K
*
* Models
*
.model qn npn(is=5e-15 bf=200 tf=0.01nS)
.model qp pnp(is=5e-15 bf=200 tf=0.01nS)
.model dclamp d(is=1e-30 ibv=0.266
+ bv=0.71v n=4)
.ends
    
```

EL2180/EL2280/EL2480 Macromodel

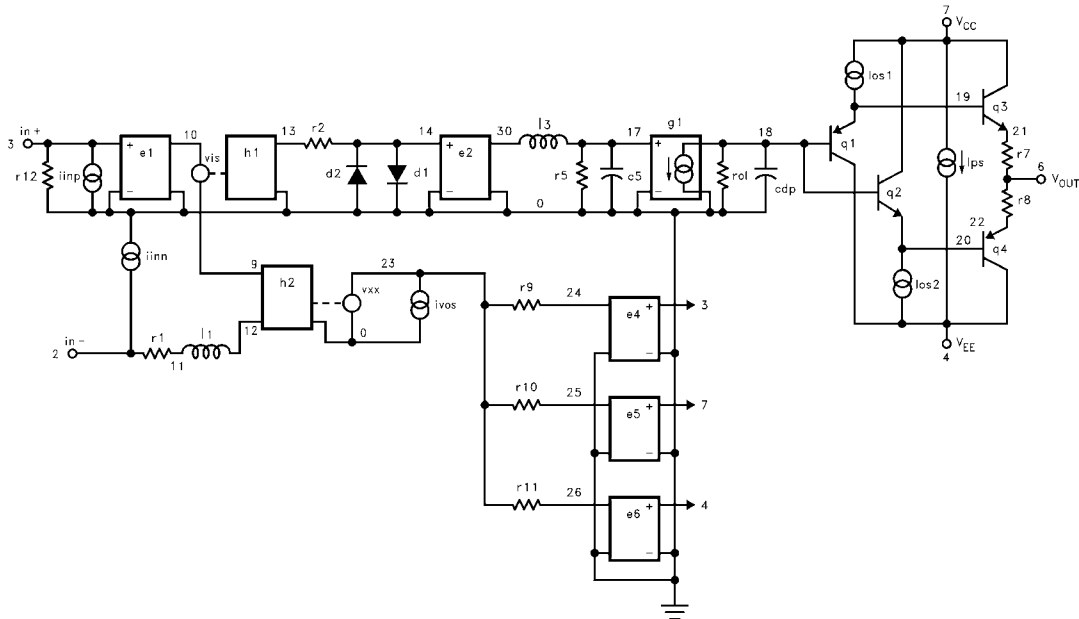

All Intersil U.S. products are manufactured, assembled and tested utilizing ISO9000 quality systems.
 Intersil Corporation's quality certifications can be viewed at www.intersil.com/design/quality

Intersil products are sold by description only. Intersil Corporation reserves the right to make changes in circuit design, software and/or specifications at any time without notice. Accordingly, the reader is cautioned to verify that data sheets are current before placing orders. Information furnished by Intersil is believed to be accurate and reliable. However, no responsibility is assumed by Intersil or its subsidiaries for its use; nor for any infringements of patents or other rights of third parties which may result from its use. No license is granted by implication or otherwise under any patent or patent rights of Intersil or its subsidiaries.

For information regarding Intersil Corporation and its products, see www.intersil.com