

V_{RSM}	V_{RRM}	$(dv/dt)_{cr}$	I_{TRMS} (maximum value for continuous operation)			
	V_{DRM}		95 A			
			I_{TAV} (sin. 180; $T_{case} = 74^{\circ}C$)			
V	V	V/ μs	60 A			
500	400	500	–	–	SKKH 56/04 D	–
700	600	500	SKKT 56/06 D	SKKT 57/06 D	SKKH 56/06 D	SKKH 57/06 D
900	800	500	SKKT 56/08 D	SKKT 57/08 D ¹⁾	SKKH 56/08 D	SKKH 57/08 D
1300	1200	1000	SKKT 56/12 E	SKKT 57/12 E ¹⁾	SKKH 56/12 E	SKKH 57/12 E
1500	1400	1000	SKKT 56/14 E	SKKT 57/14 E ¹⁾	SKKH 56/14 E	SKKH 57/14 E
1700	1600	1000	SKKT 56/16 E	SKKT 57/16 E ¹⁾	SKKH 56/16 E	SKKH 57/16 E
1900	1800	1000	SKKT 56/18 E	SKKT 57/18 E ¹⁾	SKKH 56/18 E	SKKH 57/18 E
2100	2000	1000	SKKT 56/20 E	SKKT 57/20 E ¹⁾	–	SKKH 57/20 E
2300	2200	1000	SKKT 56/22 E	SKKT 57/22 E ¹⁾	–	SKKH 57/22 E

SEMIPACK® 1 Thyristor / Diode Modules

SKKT 56 SKKH 56
SKKT 57 SKKH 57
SKKT 57B

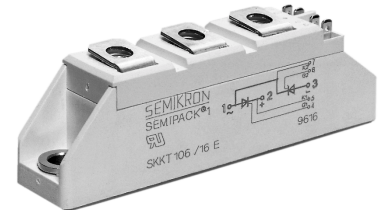

Symbol	Conditions	SKKT 56 SKKH 56	SKKT 57 SKKT 57B SKKH 57	Units
I_{TAV}	sin. 180; $T_{case} = 74^{\circ}C$ $T_{case} = 80^{\circ}C$	60	55	A
I_D	B2/B6 $T_{amb} = 45^{\circ}C$; P 3/180 $T_{amb} = 35^{\circ}C$; P 3/180 F	57 / 68	100 / 130	A
I_{RMS}	W1/W3 $T_{amb} = 35^{\circ}C$; P 3/180 F	130 / 3 x 100		A
I_{TSM}	$T_{vj} = 25^{\circ}C$; 10 ms $T_{vj} = 125^{\circ}C$; 10 ms	1 500	1 250	A
i^2t	$T_{vj} = 25^{\circ}C$; 8,3 ... 10 ms $T_{vj} = 125^{\circ}C$; 8,3 ... 10 ms	11 000	8 000	A ² s
t_{gd}	$T_{vj} = 25^{\circ}C$; $I_G = 1 A$; $di_G/dt = 1 A/\mu s$	1		μs
t_{gr}	$V_D = 0,67 \cdot V_{DRM}$	2		μs
$(di/dt)_{cr}$	$T_{vj} = 125^{\circ}C$	150		A/ μs
t_q	$T_{vj} = 125^{\circ}C$	typ. 80		μs
I_H	$T_{vj} = 25^{\circ}C$; typ./max.	150 / 250		mA
I_L	$T_{vj} = 25^{\circ}C$; $R_G = 33 \Omega$; typ./max.	300 / 600		mA
V_T	$T_{vj} = 25^{\circ}C$; $I_T = 200 A$	max. 1,65		V
$V_{T(TO)}$	$T_{vj} = 125^{\circ}C$	0,9		V
r_T	$T_{vj} = 125^{\circ}C$	3,5		m Ω
I_{DD} ; I_{RD}	$T_{vj} = 125^{\circ}C$; $V_{RD} = V_{RRM}$ $V_{DD} = V_{DRM}$	max. 15 ³⁾		mA
V_{GT}	$T_{vj} = 25^{\circ}C$; d.c.	3		V
I_{GT}	$T_{vj} = 25^{\circ}C$; d.c.	150		mA
V_{GD}	$T_{vj} = 125^{\circ}C$; d.c.	0,25		V
I_{GD}	$T_{vj} = 125^{\circ}C$; d.c.	6		mA
R_{thjc}	cont. } per thyristor / sin. 180 } per module rec. 120 }	0,57 / 0,29		$^{\circ}C/W$
R_{thch}		0,60 / 0,30		$^{\circ}C/W$
T_{vj}		0,64 / 0,32		$^{\circ}C/W$
T_{stg}		0,2 / 0,1		$^{\circ}C/W$
V_{isol}	a. c. 50 Hz; r.m.s.; 1 s/1 min	– 40 ... + 125		$^{\circ}C$
M_1	to heatsink } SI (US) units	– 40 ... + 125		$^{\circ}C$
M_2	to terminals }	3600 / 3000		V~
a		5 (44 lb. in.) $\pm 15\%$ ²⁾		Nm
w	approx.	3 (26 lb. in.) $\pm 15\%$		Nm
		5 · 9,81		m/s ²
		95		g
Case	→ page B 1 – 95	SKKT 56: A 5 SKKH 56: A 6	SKKT 57: A 46 SKKT 57B: A 48 SKKH 57: A 47	

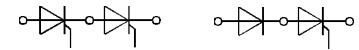

SKKT 56

SKKH 56



SKKT 57
SKKT 57B

SKKH 57

Features

- Heat transfer through aluminium oxide ceramic isolated metal baseplate
- Hard soldered joints for high reliability
- UL recognized, file no. E 63 532

Typical Applications

- DC motor control (e.g. for machine tools)
- AC motor soft starters
- Temperature control (e.g. for ovens, chemical processes)
- Professional light dimming (studios, theaters)

¹⁾ Also available in SKKT 57B configuration (case A 48)

²⁾ See the assembly instructions

³⁾ /20 E, /22 E max. 30 mA

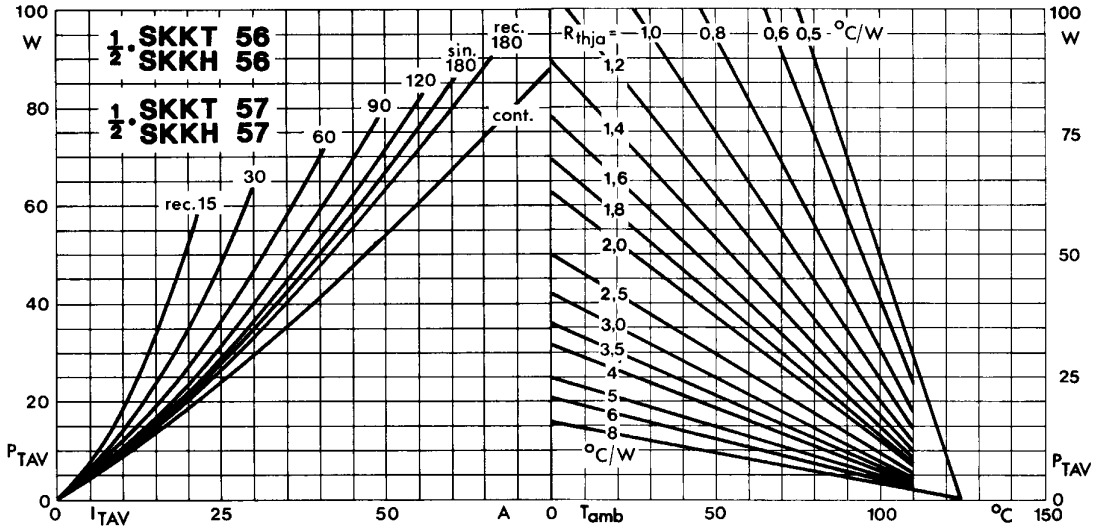

Fig. 1 Power dissipation per thyristor vs. on-state current and ambient temperature

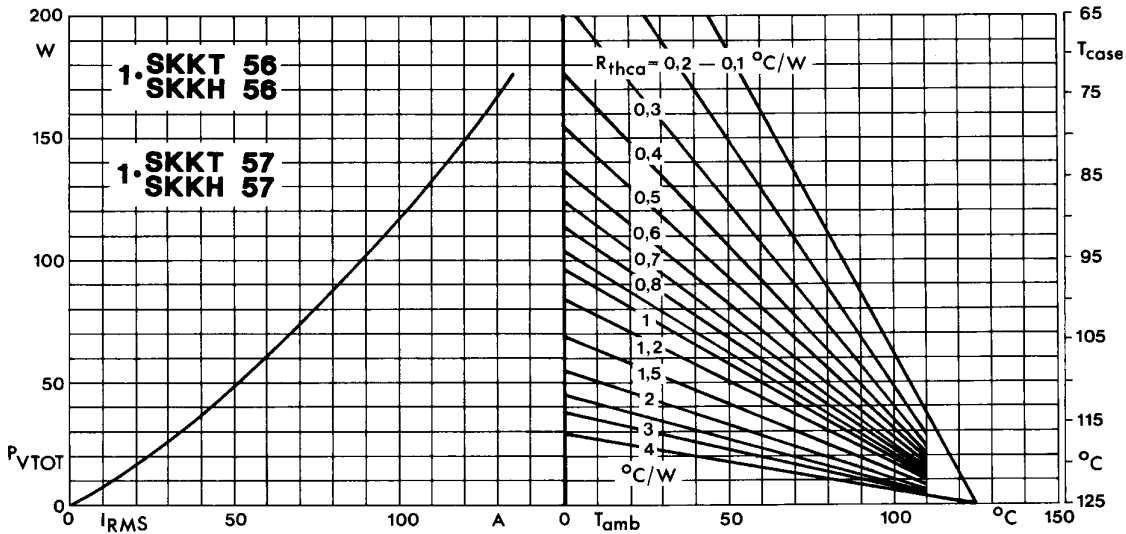

Fig. 2 Power dissipation per module vs. rms current and case temperature

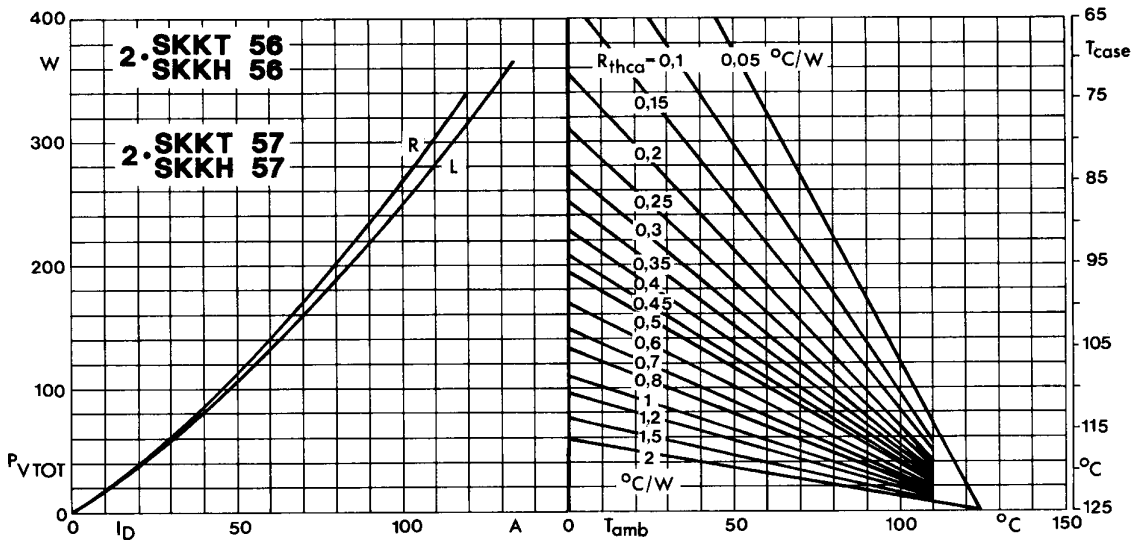

Fig. 3 Power dissipation of two modules vs. direct current and case temperature

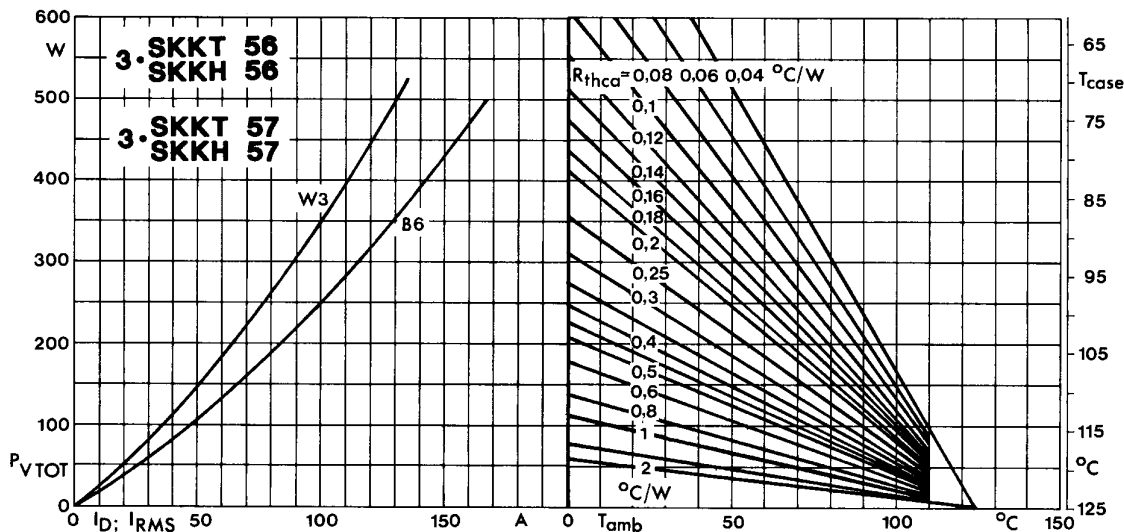

Fig. 4 Power dissipation of three modules vs. direct and rms current and case temperature

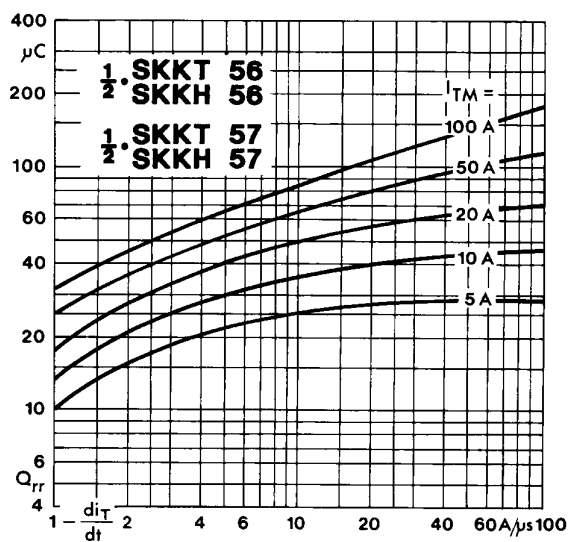

Fig. 5 Recovered charge vs. current decrease

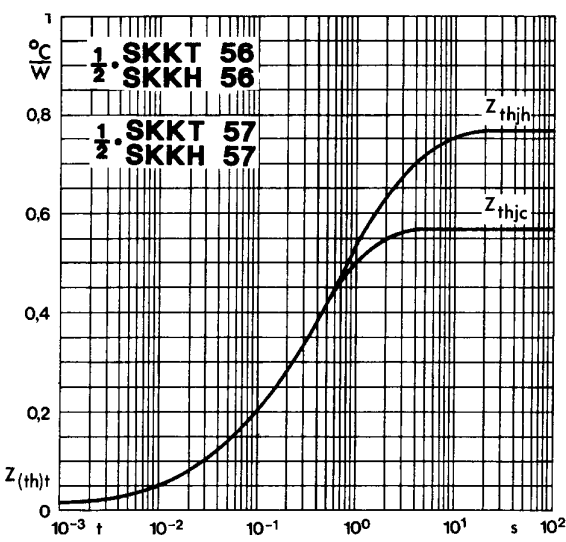

Fig. 6 Transient thermal impedance vs. time

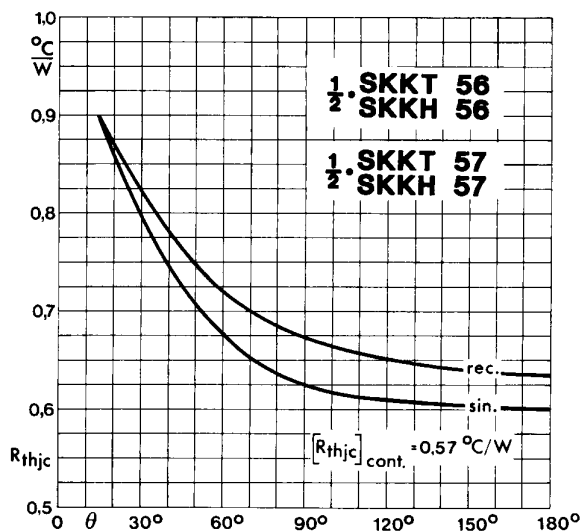

Fig. 7 Thermal resistance vs. conduction angle

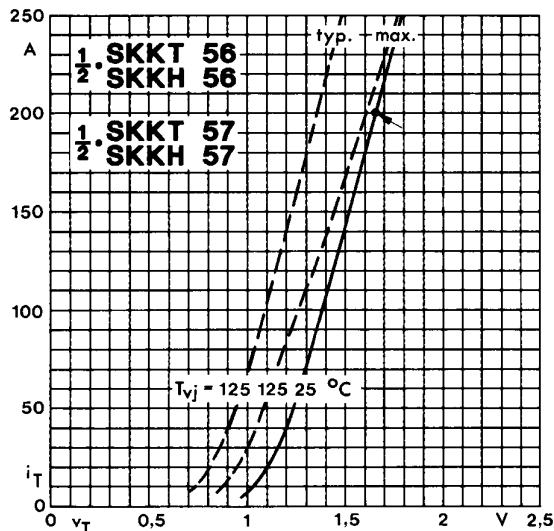

Fig. 8 On-state characteristics

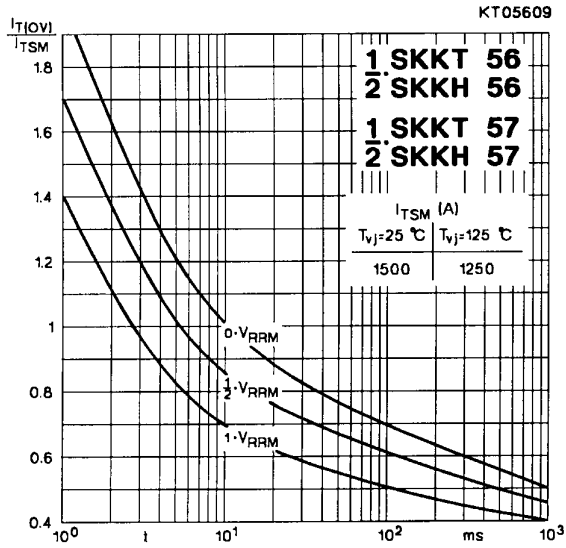

Fig. 9 Surge overload current vs. time

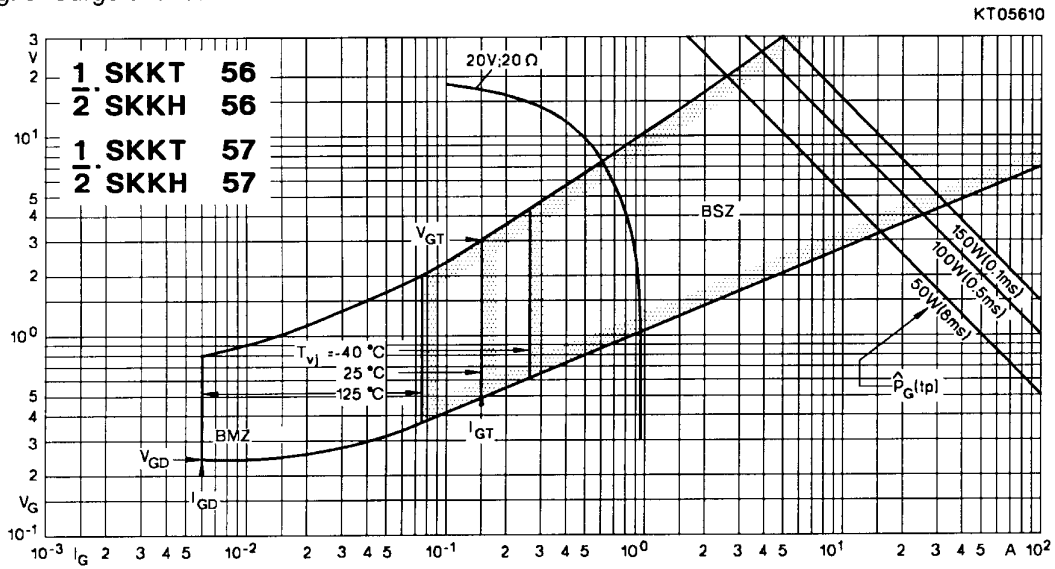

Fig. 10 Gate trigger characteristics

SKKT 19 ... 105

Case A 5

IEC 192-2: A 77 A

JEDEC: TO-240 AA

SEMIPACK® 1

UL recognized, file no. E 63 532

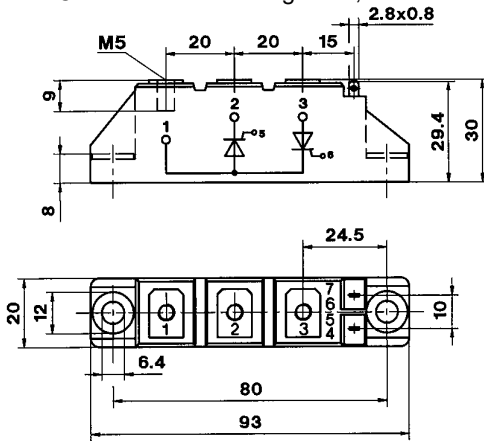

Dimensions in mm

SKKT 20/ ... 106/

Case A 46

IEC 192-2: A 77 A

JEDEC: TO-240 AA

SEMIPACK® 1

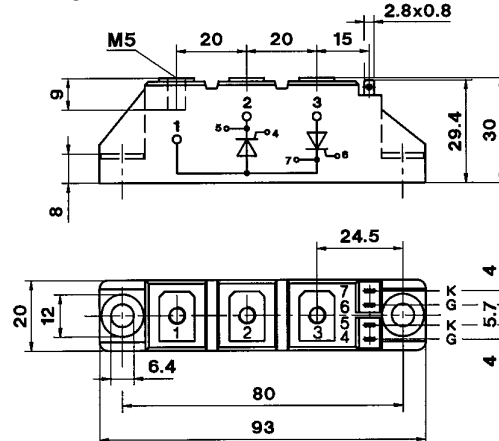

Dimensions in mm

SKKH 26 ... 105

Case A 6

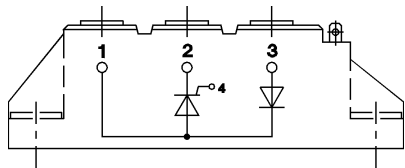

SKKD 26 ... 100

Case A 10

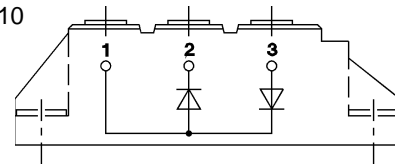

SKNH 56 ... 91

Case A 7

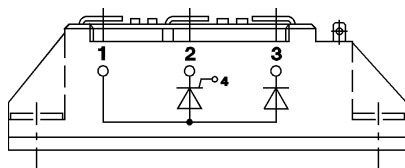

SKKE 81

Case A 12

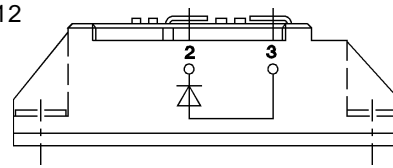

SKKL 56 ... 105

Case A 9

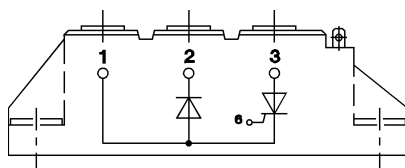

SKKH 27 ... 106

Case A 47

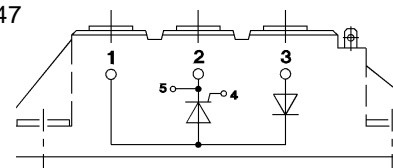

SKND 46 ... 81

Case A 19

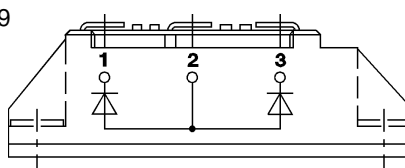

SKKT 20 B ... 106 B

Case A 48

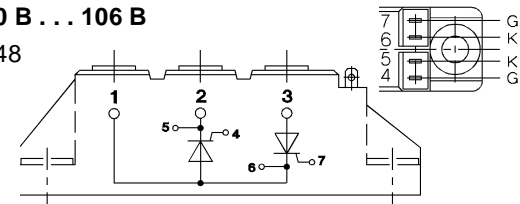

SKMT 92

Case A 72

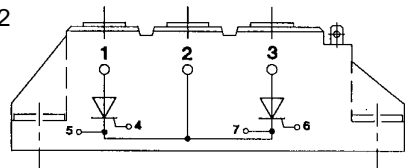

SKKL 42 ... 106

Case A 59

